

Computer Vision Toolbox™

Reference



MATLAB® & SIMULINK®

R2021b



How to Contact MathWorks



Latest news: www.mathworks.com
Sales and services: www.mathworks.com/sales_and_services
User community: www.mathworks.com/matlabcentral
Technical support: www.mathworks.com/support/contact_us



Phone: 508-647-7000



The MathWorks, Inc.
1 Apple Hill Drive
Natick, MA 01760-2098

Computer Vision Toolbox™ Reference

© COPYRIGHT 2011–2021 by The MathWorks, Inc.

The software described in this document is furnished under a license agreement. The software may be used or copied only under the terms of the license agreement. No part of this manual may be photocopied or reproduced in any form without prior written consent from The MathWorks, Inc.

FEDERAL ACQUISITION: This provision applies to all acquisitions of the Program and Documentation by, for, or through the federal government of the United States. By accepting delivery of the Program or Documentation, the government hereby agrees that this software or documentation qualifies as commercial computer software or commercial computer software documentation as such terms are used or defined in FAR 12.212, DFARS Part 227.72, and DFARS 252.227-7014. Accordingly, the terms and conditions of this Agreement and only those rights specified in this Agreement, shall pertain to and govern the use, modification, reproduction, release, performance, display, and disclosure of the Program and Documentation by the federal government (or other entity acquiring for or through the federal government) and shall supersede any conflicting contractual terms or conditions. If this License fails to meet the government's needs or is inconsistent in any respect with federal procurement law, the government agrees to return the Program and Documentation, unused, to The MathWorks, Inc.

Trademarks

MATLAB and Simulink are registered trademarks of The MathWorks, Inc. See www.mathworks.com/trademarks for a list of additional trademarks. Other product or brand names may be trademarks or registered trademarks of their respective holders.

Patents

MathWorks products are protected by one or more U.S. patents. Please see www.mathworks.com/patents for more information.

Revision History

April 2011	Online only	Revised for Version 4.0 (Release 2011a)
September 2011	Online only	Revised for Version 4.1 (Release 2011b)
March 2012	Online only	Revised for Version 5.0 (Release 2012a)
September 2012	Online only	Revised for Version 5.1 (Release R2012b)
March 2013	Online only	Revised for Version 5.2 (Release R2013a)
September 2013	Online only	Revised for Version 5.3 (Release R2013b)
March 2014	Online only	Revised for Version 6.0 (Release R2014a)
October 2014	Online only	Revised for Version 6.1 (Release R2014b)
March 2015	Online only	Revised for Version 6.2 (Release R2015a)
September 2015	Online only	Revised for Version 7.0 (Release R2015b)
March 2016	Online only	Revised for Version 7.1 (Release R2016a)
September 2016	Online only	Revised for Version 7.2 (Release R2016b)
March 2017	Online only	Revised for Version 7.3 (Release R2017a)
September 2017	Online only	Revised for Version 8.0 (Release R2017b)
March 2018	Online only	Revised for Version 8.1 (Release R2018a)
September 2018	Online only	Revised for Version 8.2 (Release R2018b)
March 2019	Online only	Revised for Version 9.0 (Release R2019a)
September 2019	Online only	Revised for Version 9.1 (Release R2019b)
March 2020	Online only	Revised for Version 9.2 (Release R2020a)
September 2020	Online only	Revised for Version 9.3 (Release R2020b)
March 2021	Online only	Revised for Version 10.0 (Release R2021a)
September 2021	Online only	Revised for Version 10.1 (Release R2021b)

1	<hr/>	Blocks
2	<hr/>	Objects
3	<hr/>	Functions

Blocks

2-D Autocorrelation

2-D autocorrelation of input matrix

Library: Computer Vision Toolbox / Statistics

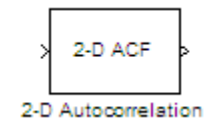

Description

The 2-D Autocorrelation block computes the 2-D autocorrelation of the input vector or matrix.

Ports

Input

Port_1 — Input array

vector | matrix

Input array, specified as a vector or matrix.

Data Types: single | double | int8 | int16 | int32 | uint8 | uint16 | uint32 | fixed point
Complex Number Support: Yes

Output

Port_1 — Autocorrelation of input

vector | matrix

Autocorrelation of the input array, returned as a vector or matrix. The data type of the output is the same as that of the input.

Data Types: single | double | int8 | int16 | int32 | uint8 | uint16 | uint32 | fixed point
Complex Number Support: Yes

Parameters

For details on fixed-point block parameters, see “Specify Fixed-Point Attributes for Blocks”.

Lock data type settings against change by the fixed-point tools — Prevent fixed-point tools from overriding data types

off (default) | on

Select this parameter to prevent the fixed-point tools from overriding the data types you specify in this block. For more information, see “Lock the Output Data Type Setting” (Fixed-Point Designer).

Block Characteristics

Data Types	double fixed point integer single
-------------------	---

Multidimensional Signals	no
Variable-Size Signals	yes

Algorithms

If the input A is a vector with dimension M -by-1 then the equation for 1-D discrete autocorrelation is:

where $0 \leq n \leq 2M - 1$.

The output is an autocorrelation vector of size $(2M - 1, 1)$.

If the input A is a matrix with dimension M -by- N then the equation for the 2-D discrete autocorrelation is:

where $0 \leq i < 2M - 1$ and $0 \leq j < 2N - 1$.

The dimension of the output autocorrelation matrix is $(2M - 1, 2N - 1)$.

Extended Capabilities

C/C++ Code Generation

Generate C and C++ code using Simulink® Coder™.

See Also

Blocks

2-D Correlation | 2-D Histogram | 2-D Mean | 2-D Median | 2-D Standard Deviation | 2-D Variance | 2-D Maximum | 2-D Minimum

Introduced before R2006a

2-D Convolution

Compute 2-D discrete convolution of two input matrices

Library: Computer Vision Toolbox / Filtering

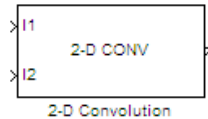

Description

The 2-D Convolution block computes the two-dimensional convolution of two input matrices. Assume that matrix A has dimensions (Ma, Na) and matrix B has dimensions (Mb, Nb) . When the block calculates the full output size, the equation for the 2-D discrete convolution is:

$$C(i, j) = \sum_{m=0}^{(Ma-1)} \sum_{n=0}^{(Na-1)} A(m, n) * B(i-m, j-n)$$

where $0 \leq i < Ma + Mb - 1$ and $0 \leq j < Na + Nb - 1$.

Ports

Input

I1 — Input matrix

matrix

Input matrix, specified as either a matrix of intensity values or a matrix that represents one plane of an RGB video stream.

Data Types: single | double | int8 | int16 | int32 | int64 | uint8 | uint16 | uint32 | uint64 | fixed point

I2 — Input matrix

matrix

Input matrix, specified as either a matrix of intensity values or a matrix that represents one plane of an RGB video stream.

Data Types: single | double | int8 | int16 | int32 | int64 | uint8 | uint16 | uint32 | uint64 | fixed point

Output

Output — Convolution

matrix

Convolution of the input matrices, returned as a matrix.

Dependencies

- The dimensions of the output are dictated by the **Output size** parameter.
- If the data type of the input is floating point, the output of the block is also floating point.
- If `all(size(I1)<size(I2))`, the block returns an error.

Data Types: `single | double | int8 | int16 | int32 | int64 | uint8 | uint16 | uint32 | uint64 | fixed point`

Parameters**Main Tab****Output size – Output size**

matrix

Dimensions of the output.

The table describes the block output, given the following input dimensions:

- **I1** — (Ma, Na)
- **I2** — (Mb, Nb)

Output size	Output	Output Dimension
Full	Full two-dimensional convolution	$(Ma+Mb-1, Na+Nb-1)$.
Same as input port I1	Central part of the convolution with the same dimensions as the input at port I1	
Valid	Only the parts of the convolution that are computed without the zero-padded edges of any input.	$(Ma-Mb+1, Na-Nb+1)$

Normalized output – Normalized output

matrix

Normalize output by dividing the output by `sqrt(sum(dot(I1p, I1p))*sum(dot(I2, I2)))`, where `I1p` is the portion of the **I1** matrix that aligns with the **I2** matrix.

Note When you select the **Normalized output** check box, the block input cannot be fixed point.

Data Types Tab

For details on the fixed-point block parameters, see “Specify Fixed-Point Attributes for Blocks” .

Block Characteristics

Data Types	<code>double fixed point integer single</code>
-------------------	--

Multidimensional Signals	no
Variable-Size Signals	yes

Algorithms

2-D Convolution

In convolution, the value of an output element is computed as a weighted sum of neighboring elements.

For example, suppose the first input matrix represents an image and is defined as:

$$\mathbf{I1} = \begin{bmatrix} 17 & 24 & 1 & 8 & 15 \\ 23 & 5 & 7 & 14 & 16 \\ 4 & 6 & 13 & 20 & 22 \\ 10 & 12 & 19 & 21 & 3 \\ 11 & 18 & 25 & 2 & 9 \end{bmatrix}$$

The second input matrix also represents an image and is defined as:

$$\mathbf{I2} = \begin{bmatrix} 8 & 1 & 6 \\ 3 & 5 & 7 \\ 4 & 9 & 2 \end{bmatrix}$$

The following figure shows how to compute the (1,1) output element by using these steps:

- 1** Rotate the second input matrix, **I2**, 180 degrees around its center element.
- 2** Slide the center element of **I2** so that it lies on top of the (0,0) element of **I1**.
- 3** Multiply each element of the rotated **I2** matrix by the element of **I1** underneath.
- 4** Sum the individual products from step 3.

The (1,1) output element is $0 \cdot 2 + 0 \cdot 9 + 0 \cdot 4 + 0 \cdot 7 + 17 \cdot 5 + 24 \cdot 3 + 0 \cdot 6 + 23 \cdot 1 + 5 \cdot 8 = 220$.

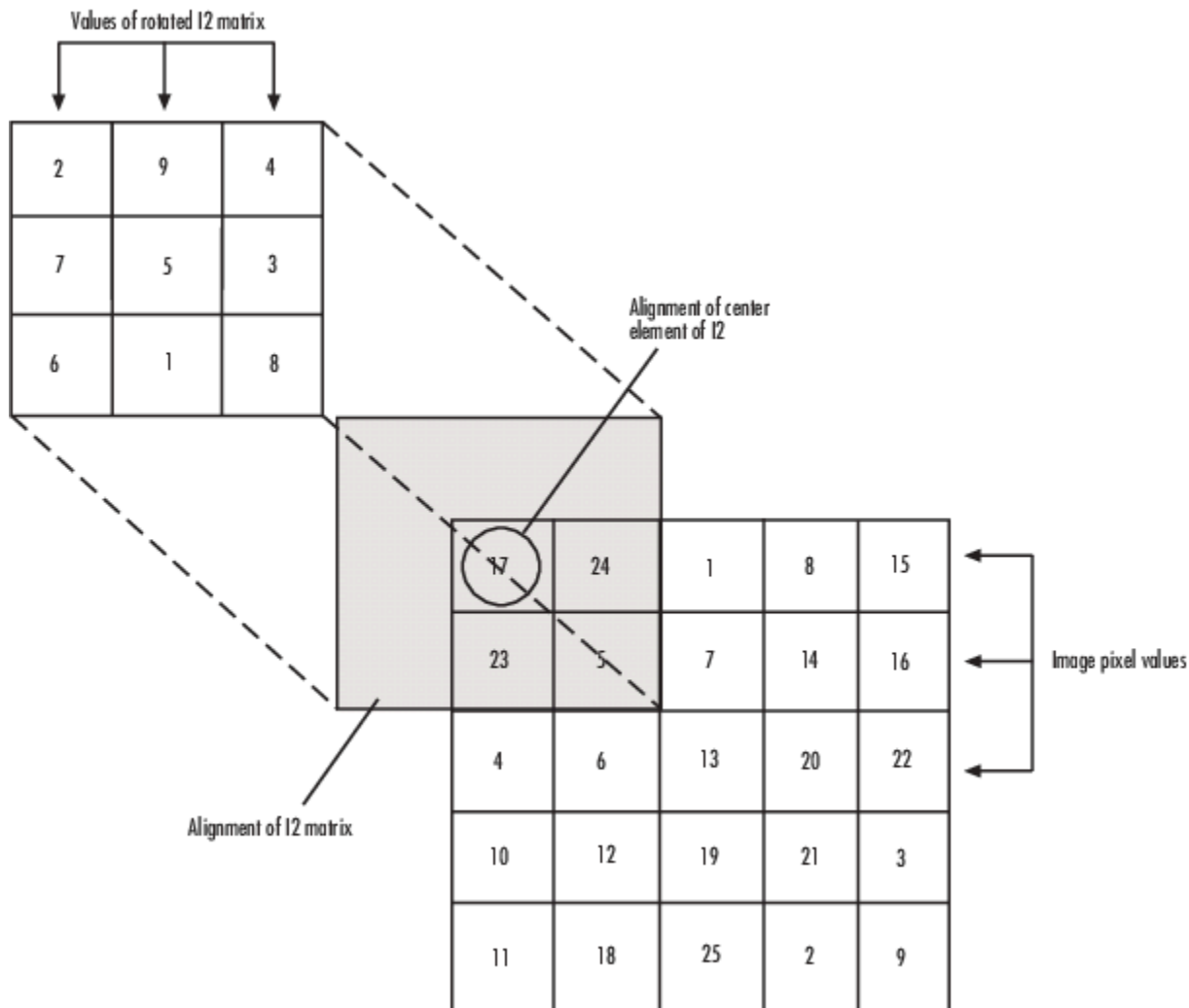

Computing the (1,1) Output of Convolution

The normalized convolution of the (1,1) output element is $220 / \sqrt{(\text{sum}(\text{dot}(I1p, I1p)) * \text{sum}(\text{dot}(I2, I2)))} = 0.3459$, where $I1p = [0 \ 0 \ 0; 0 \ 17 \ 24; 0 \ 23 \ 5]$.

Output Sizes

The equations below describe how the block computes the convolution depending on how you set the **Output size** parameter. For the cases below, the inputs are set as:

- **I1** — dimensions (4,3)
- **I2** — dimensions (2,2)
- When **Output size** is set to Full, the block uses the following equations:

$$C_{\text{full_rows}} = I1_{\text{rows}} + I2_{\text{rows}} - 1 = 5$$

$$C_{\text{full}_{\text{columns}}} = I1_{\text{columns}} + I2_{\text{columns}} - 1 = 4$$

The resulting matrix is:

$$C_{\text{full}} = \begin{bmatrix} c_{00} & c_{01} & c_{02} & c_{03} \\ c_{10} & c_{11} & c_{12} & c_{13} \\ c_{20} & c_{21} & c_{22} & c_{23} \\ c_{30} & c_{31} & c_{32} & c_{33} \\ c_{40} & c_{41} & c_{42} & c_{43} \end{bmatrix}$$

- When **Output size** is set to **Same** as input port **I1**, the output is the central part of C_{full} with the same dimensions as the input at port **I1**, (4,3). However, since a 4-by-3 matrix cannot be extracted from the exact center of C_{full} , the block leaves more rows and columns on the top and left side of the C_{full} matrix and outputs:

$$C_{\text{same}} = \begin{bmatrix} c_{11} & c_{12} & c_{13} \\ c_{21} & c_{22} & c_{23} \\ c_{31} & c_{32} & c_{33} \\ c_{41} & c_{42} & c_{43} \end{bmatrix}$$

- When the **Output size** is set to **Valid**, the block uses the following equations to determine the number of rows and columns of the output matrix:

$$C_{\text{valid}_{\text{rows}}} = I1_{\text{rows}} - I2_{\text{rows}} + 1 = 3$$

$$C_{\text{valid}_{\text{columns}}} = I1_{\text{columns}} - I2_{\text{columns}} + 1 = 2$$

In this case, it is always possible to extract the exact center of C_{full} . Therefore, the block outputs:

$$C_{\text{full}} = \begin{bmatrix} c_{11} & c_{12} \\ c_{21} & c_{22} \\ c_{31} & c_{32} \end{bmatrix}$$

Extended Capabilities

C/C++ Code Generation

Generate C and C++ code using Simulink® Coder™.

Fixed-Point Conversion

Design and simulate fixed-point systems using Fixed-Point Designer™.

When you select the **Normalized output** check box, the block input cannot be fixed point.

See Also

2-D FIR Filter

Introduced before R2006a

2-D Correlation

Compute 2-D correlation of two input matrices

Library: Computer Vision Toolbox / Statistics

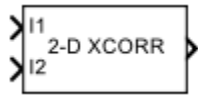

Description

The 2-D Correlation block computes the two-dimensional cross-correlation between two input matrices.

Ports

Input

I1 — First input matrix

M-by-*N* matrix

First input matrix, specified as a *M*-by-*N* matrix.

Data Types: `single` | `double` | `int8` | `int16` | `int32` | `int64` | `uint8` | `uint16` | `uint32` | `uint64` | `fixed point`

Complex Number Support: Yes

I2 — Second input matrix

P-by-*Q* matrix

Second input matrix, specified as a *P*-by-*Q* matrix.

Data Types: `single` | `double` | `int8` | `int16` | `int32` | `int64` | `uint8` | `uint16` | `uint32` | `uint64` | `fixed point`

Complex Number Support: Yes

Output

Port_1 — Calculated cross-correlation

scalar | vector | matrix

Calculated cross-correlation, returned as a scalar, vector, or matrix. The size of the cross-correlation output depends on the **Output size** parameter.

Data Types: `single` | `double` | `int8` | `int16` | `int32` | `int64` | `uint8` | `uint16` | `uint32` | `uint64` | `fixed point`

Complex Number Support: Yes

Parameters

Main Tab

Output size — Size of cross-correlation output

Full (default) | Same as input port I1 | Valid

Size of the cross-correlation output.

- If you choose **Full**, the output has the dimensions $(M+P-1)$ -by- $(N+Q-1)$.
- If you choose **Same as input port I1**, the output has the same dimensions as the input at port **I1**. The block returns the central part of cross-correlation matrix, which is the same size as the input at port **I1**.
- If you choose **Valid**, the output has the dimensions $(M-P+1)$ -by- $(N-Q+1)$. The block returns only parts of the cross-correlation matrix that are computed without zero-padded edges.

Normalized output — Normalize cross-correlation output

off (default) | on

Select this parameter, if the data types of the inputs are floating-point. The values of the cross-correlation output are normalized to $[0, 1]$.

Data Types Tab

For details on the fixed-point block parameters, see “Specify Fixed-Point Attributes for Blocks”.

Lock data type settings against change by the fixed-point tools — Prevent fixed-point tools from overriding data types

off (default) | on

Select this parameter to prevent the fixed-point tools from overriding the data types you specify on this block. For more information, see “Lock the Output Data Type Setting” (Fixed-Point Designer).

Block Characteristics

Data Types	double fixed point integer single
Multidimensional Signals	no
Variable-Size Signals	yes

Algorithms

Given two input matrices, $I1$ and $I2$, that are size M -by- N and P -by- Q , the 2-D cross-correlation value at the point (k, l) is given by

$$C(k, l) = \sum_{m=0}^{M-1} \sum_{n=0}^{N-1} I1(m, n) \overline{I2(m+k, n+l)}.$$

The normalized cross-correlation value at the point (k, l) is calculated as

$$C_N(k, l) = \frac{\sum_{m=0}^{M-1} \sum_{n=0}^{N-1} I1(m, n) \overline{I2}(m+k, n+l)}{\sqrt{\sum_{m=0}^{M-1} \sum_{n=0}^{N-1} I1(m, n)^2} \sqrt{\sum_{m=0}^{M-1} \sum_{n=0}^{N-1} \overline{I2}(m+k, n+l)^2}},$$

where,

$$0 \leq k < M + P - 1$$

$$0 \leq l < N + Q - 1$$

Suppose $I1$ and $I2$ are matrices with dimensions (4,3) and (2,2). The following figure shows how the block computes cross-correlation value for the point $I1(1, 3)$, which refers to the second column and fourth row in zero-based indexing.

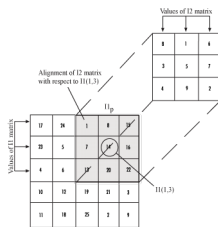

The cross-correlation value for the point $I1(1, 3)$ is computed using these steps:

- 1 Slide the center element of $I2$ so that it lies on top of the (0,2) element of $I1$.
- 2 Multiply each weight in $I2$ by the element of $I1$ underneath.
- 3 Sum the individual products from step 2.

The cross-correlation value for the point $I1(1, 3)$ is
 $1 \cdot 8 + 8 \cdot 1 + 15 \cdot 6 + 7 \cdot 3 + 14 \cdot 5 + 16 \cdot 7 + 13 \cdot 4 + 20 \cdot 9 + 22 \cdot 2 = 585$.

The normalized cross-correlation value for the point $I1(1, 3)$ is

$$\frac{585}{\sqrt{\sum I1_p^2} \sqrt{\sum I2^2}} = 0.8070.$$

Extended Capabilities

C/C++ Code Generation

Generate C and C++ code using Simulink® Coder™.

Fixed-Point Conversion

Design and simulate fixed-point systems using Fixed-Point Designer™.

See Also

2-D Autocorrelation | 2-D Mean | 2-D Histogram | 2-D Median | 2-D Standard Deviation | 2-D Variance | 2-D Maximum | 2-D Minimum

Introduced before R2006a

2-D DCT

Compute 2-D discrete cosine transform (DCT)

Library: Computer Vision Toolbox / Transforms



Description

The 2-D DCT block calculates the two-dimensional discrete cosine transform of an image. Suppose $f(x,y)$ is the input image of dimension M -by- N , the equation for the 2-D DCT is

$$F(m, n) = \frac{2}{\sqrt{MN}} C(m)C(n) \sum_{x=0}^{M-1} \sum_{y=0}^{N-1} f(x, y) \cos \frac{(2x+1)m\pi}{2M} \cos \frac{(2y+1)n\pi}{2N}$$

where $C(m) = C(n) = 1/\sqrt{2}$ for $m, n = 0$ and $C(m), C(n) = 1$ otherwise.

The number of rows and columns of the input image must be power of 2. You can also use this block to compute 1-D DCT of a vector.

Ports

Input

Port_1 — Input data

matrix | vector

Input data, specified as a numeric matrix or a vector. The size of the input data must be power of 2.

Data Types: single | double | int8 | int16 | int32 | int64 | uint8 | uint16 | uint32 | uint64 | Boolean | fixed point

Output

Port_1 — Output data

matrix | vector

Output data containing the DCT coefficients, returned as a matrix or vector. The size and the datatype of the output is same as that of the input.

Data Types: single | double | int8 | int16 | int32 | int64 | uint8 | uint16 | uint32 | uint64 | Boolean | fixed point

Parameters

Main Tab

Sine and cosine computation — Specify how the block computes the sine and cosine terms`Table lookup (default) | Trigonometric fcn`

Use this parameter to specify how the block computes the sine and cosine terms in the DCT algorithm.

- If you select `Trigonometric fcn`, the block computes the sine and cosine values during the simulation.
- If you select `Table lookup`, the block computes and stores the trigonometric values before the simulation starts. In this case, the block requires extra memory. `Table lookup` is the default.

Data Types Tab**Fixed-point operational parameters****Rounding mode — Rounding mode for fixed-point representation**`Floor (default) | Ceiling | Convergent | Nearest | Round | Simplest | Zero`

Use this parameter to specify the rounding mode for the block to use when the specified data type and scaling cannot exactly represent the result of a fixed-point calculation. See Rounding Modes for more information on the available values.

Note The sine table values do not obey this parameter; they always round to `Nearest`.

Saturate on integer overflow — Specify overflow mode`off (default) | on`

When you select this parameter, the block saturates the result of its fixed-point operation. When you clear this parameter, the block wraps the result of its fixed-point operation.

For details on saturate and wrap, see “Overflow Handling” for fixed-point operations.

Note The sine table values do not obey this parameter; instead, they are always saturated.

Fixed-point data types**Sine Table — Data type of sine table**`Inherit: Same word length as input (default) | fixdt(1,16) | <data type expression>`

Use this parameter to specify the word length of the values of the sine table. The fraction length of the sine table values always equals the word length minus one.

The sine table values do not obey the **Rounding mode** and **Saturate on integer overflow** parameters; instead, they are always saturated and rounded to `Nearest`.

Product output — Data type of product output`Inherit: Inherit via internal rule (default) | Inherit: Same as input | fixdt(1,16,0) | <data type expression>`

Use this parameter to specify the product output data type. See “Fixed-Point Data Types” on page 1-15 and “Multiplication Data Types” for illustrations depicting the use of the product output data type in this block.

Accumulator — Data type of accumulator

Inherit: `Inherit via internal rule (default)` | `Inherit: Same as input` | `Inherit: Same as product output` | `fixdt(1,16,0)` | `<data type expression>`

Use this parameter to specify the accumulator data type. See “Fixed-Point Data Types” on page 1-15 for illustrations depicting the use of the accumulator data type in this block.

Output — Data type of output

Inherit: `Inherit via internal rule (default)` | `Inherit: Same as input` | `fixdt(1,16,0)` | `<data type expression>`

Use this parameter to specify the output data type. See “Fixed-Point Data Types” on page 1-15 for illustrations depicting the use of the output data type in this block. When you set this parameter to

- `Inherit: Inherit via internal rule`, the block calculates the output word length and fraction length automatically. The internal rule first calculates an ideal output word length and fraction length using the following equations:

$$WL_{idealoutput} = WL_{input} + \text{floor}(\log_2(DCTlength - 1)) + 1$$

$$FL_{idealoutput} = FL_{input}$$

Using these ideal results, the internal rule then selects word lengths and fraction lengths that are appropriate for your hardware. For more information, see “Inherit via Internal Rule”.

Lock data type settings against change by the fixed-point tools — Data type override

`off (default)` | `on`

Select this parameter to prevent the fixed-point tools from overriding the data types you specify on the block mask. For more information, see `fxptdlg`, a reference page on the Fixed-Point Tool.

Block Characteristics

Data Types	<code>double</code> <code>fixed point</code> <code>integer</code> <code>single</code>
Multidimensional Signals	<code>no</code>
Variable-Size Signals	<code>no</code>

More About

Fixed-Point Data Types

The following diagram shows the data types used in the 2-D DCT block for fixed-point signals. Inputs are first cast to the output data type and stored in the output buffer. Each butterfly stage processes signals in the accumulator data type, with the final output of the butterfly being cast back into the output data type.

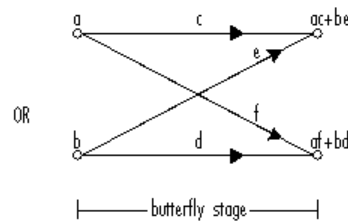
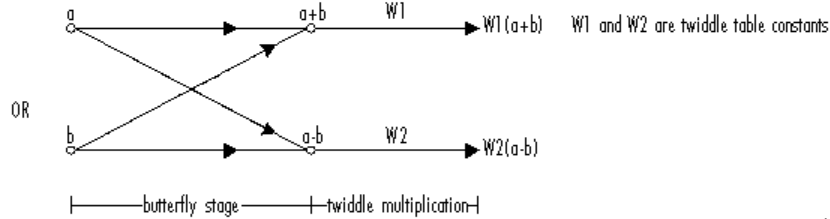
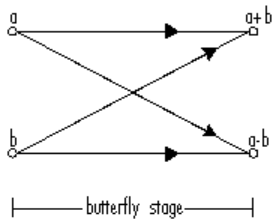

Butterfly Stage Data Types

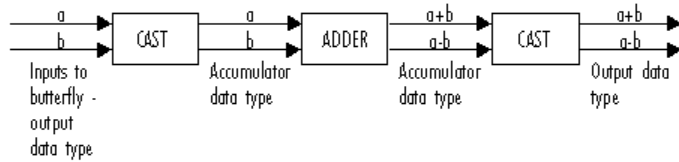

Twiddle Multiplication Data Types

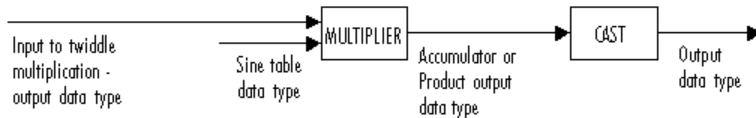

The output of the multiplier is in the product output data type when at least one of the inputs to the multiplier is real. When both inputs to the multiplier are complex, the result of the multiplication is in the accumulator data type. For details on the complex multiplication performed, refer to "Multiplication Data Types". You can set the sine table, product output, accumulator, and output data types in the block mask as discussed in the next section.

References

[1] Chen, W.H, C.H. Smith, and S.C. Fralick, "A fast computational algorithm for the discrete cosine transform," *IEEE Trans. Communications*, 25 (1977): 1004-1009.

[2] Wang, Z. "Fast algorithms for the discrete W transform and for the discrete Fourier transform," *IEEE Trans. Acoust., Speech, Signal Processing*, 32 (August 1984): 803-816.

Extended Capabilities

C/C++ Code Generation

Generate C and C++ code using Simulink® Coder™.

See Also

Blocks

2-D IDCT | 2-D FFT | 2-D IFFT

Functions

dct2 | idct2

Introduced before R2006a

2-D FFT

Compute two-dimensional fast Fourier transform of input

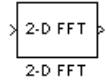

Library

Transforms

visiontransforms

Description

The 2-D FFT block computes the fast Fourier transform (FFT). The block does the computation of a two-dimensional M -by- N input matrix in two steps. First it computes the one-dimensional FFT along one dimension (row or column). Then it computes the FFT of the output of the first step along the other dimension (column or row).

The output of the 2-D FFT block is equivalent to the MATLAB® `fft2` function:

```
y = fft2(A)    % Equivalent MATLAB code
```

Computing the FFT of each dimension of the input matrix is equivalent to calculating the two-dimensional discrete Fourier transform (DFT), which is defined by the following equation:

$$F(m, n) = \sum_{x=0}^{M-1} \sum_{y=0}^{N-1} f(x, y) e^{-j \frac{2\pi m x}{M}} e^{-j \frac{2\pi n y}{N}}$$

where $0 \leq m \leq M - 1$ and $0 \leq n \leq N - 1$.

The output of this block has the same dimensions as the input. If the input signal has a floating-point data type, the data type of the output signal uses the same floating-point data type. Otherwise, the output can be any fixed-point data type. The block computes scaled and unscaled versions of the FFT.

The input to this block can be floating-point or fixed-point, real or complex, and conjugate symmetric. The block uses one of two possible FFT implementations. You can select an implementation based on the FFTW library [1], [2], or an implementation based on a collection of Radix-2 algorithms. You can select Auto to allow the block to choose the implementation.

Port Description

Port	Description	Supported Data Types	Complex Values Supported
Input	Vector or matrix of intensity values	<ul style="list-style-type: none"> • Double-precision floating point • Single-precision floating point • Fixed point • 8-, 16-, 32-bit signed integer • 8-, 16-, 32-bit unsigned integer 	Yes
Output	2-D FFT of the input	Same as Input port	Yes

FFTW Implementation

The FFTW implementation provides an optimized FFT calculation including support for power-of-two and non-power-of-two transform lengths in both simulation and code generation. Generated code using the FFTW implementation will be restricted to those computers which are capable of running MATLAB. The input data type must be floating-point.

Radix-2 Implementation

The Radix-2 implementation supports bit-reversed processing, fixed or floating-point data, and allows the block to provide portable C-code generation using the “Simulink Coder”. The dimensions of the input matrix, M and N , must be powers of two. To work with other input sizes, use the Image Pad block to pad or truncate these dimensions to powers of two, or if possible choose the FFTW implementation.

With Radix-2 selected, the block implements one or more of the following algorithms:

- Butterfly operation
- Double-signal algorithm
- Half-length algorithm
- Radix-2 decimation-in-time (DIT) algorithm
- Radix-2 decimation-in-frequency (DIF) algorithm

Radix-2 Algorithms for Real or Complex Input Complexity Floating-Point Signals

Other Parameter Settings	Algorithms Used for IFFT Computation
<input type="checkbox"/> Input is in bit-reversed order <input type="checkbox"/> Input is conjugate symmetric	Butterfly operation and radix-2 DIT
<input checked="" type="checkbox"/> Input is in bit-reversed order <input type="checkbox"/> Input is conjugate symmetric	Radix-2 DIF
<input type="checkbox"/> Input is in bit-reversed order <input checked="" type="checkbox"/> Input is conjugate symmetric	Butterfly operation and radix-2 DIT in conjunction with the half-length and double-signal algorithms
<input checked="" type="checkbox"/> Input is in bit-reversed order <input checked="" type="checkbox"/> Input is conjugate symmetric	Radix-2 DIF in conjunction with the half-length and double-signal algorithms

Radix-2 Algorithms for Real or Complex Input Complexity Fixed-Point Signals

Other Parameter Settings	Algorithms Used for IFFT Computation
<input type="checkbox"/> Input is in bit-reversed order <input type="checkbox"/> Input is conjugate symmetric	Butterfly operation and radix-2 DIT
<input checked="" type="checkbox"/> Input is in bit-reversed order <input type="checkbox"/> Input is conjugate symmetric	Radix-2 DIF

Note The **Input is conjugate symmetric** parameter cannot be used for fixed-point signals.

Radix-2 Optimization for the Table of Trigonometric Values

In certain situations, the block's Radix-2 algorithm computes all the possible trigonometric values of the twiddle factor

$$e^{j\frac{2\pi k}{K}}$$

where K is the greater value of either M or N and $k = 0, \dots, K - 1$. The block stores these values in a table and retrieves them during simulation. The number of table entries for fixed-point and floating-point is summarized in the following table:

Number of Table Entries for N-Point FFT	
floating-point	$3N/4$
fixed-point	N

Fixed-Point Data Types

The following diagrams show the data types used in the FFT block for fixed-point signals. You can set the sine table, accumulator, product output, and output data types displayed in the diagrams in the FFT dialog box as discussed in "Parameters" on page 1-21.

Inputs to the FFT block are first cast to the output data type and stored in the output buffer. Each butterfly stage then processes signals in the accumulator data type, with the final output of the butterfly being cast back into the output data type. The block multiplies in a twiddle factor before each butterfly stage in a decimation-in-time FFT and after each butterfly stage in a decimation-in-frequency FFT.

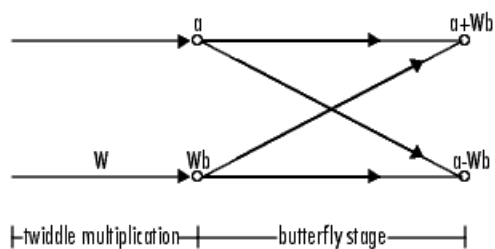
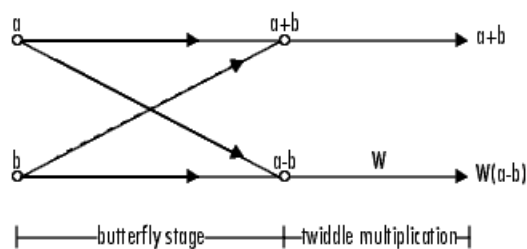
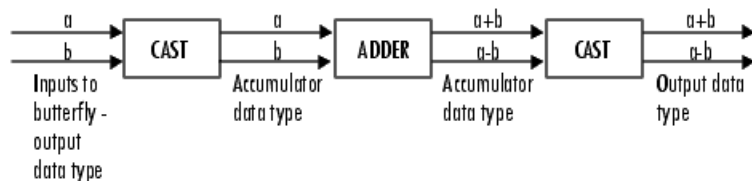
Decimation-in-time IFFT**Decimation-in-frequency IFFT****Butterfly stage data types****Twiddle multiplication data types**

The multiplier output appears in the accumulator data type because both of the inputs to the multiplier are complex. For details on the complex multiplication performed, refer to “Multiplication Data Types”.

Parameters

FFT implementation

Set this parameter to FFTW [1], [2] to support an arbitrary length input signal. The block restricts generated code with FFTW implementation to host computers capable of running MATLAB.

Set this parameter to Radix-2 for bit-reversed processing, fixed or floating-point data, or for portable C-code generation using the “Simulink Coder”. The dimensions of the input matrix, M and N , must be powers of two. To work with other input sizes, use the Image Pad block to pad or truncate these dimensions to powers of two, or if possible choose the FFTW implementation. See “Radix-2 Implementation” on page 1-19.

Set this parameter to Auto to let the block choose the FFT implementation. For non-power-of-two transform lengths, the block restricts generated code to MATLAB host computers.

Output in bit-reversed order

Designate the order of the output channel elements relative to the ordering of the input elements. When you select this check box, the output channel elements appear in bit-reversed order relative to the input ordering. If you clear this check box, the output channel elements appear in linear order relative to the input ordering.

Linearly ordering the output requires extra data sorting manipulation. For more information, see “Bit-Reversed Order” on page 1-23.

Scale result by FFT length

When you select this parameter, the block divides the output of the FFT by the FFT length. This option is useful when you want the output of the FFT to stay in the same amplitude range as its input. This is particularly useful when working with fixed-point data types.

Rounding mode

Select the “Rounding Modes” for fixed-point operations. The sine table values do not obey this parameter; instead, they always round to Nearest.

Saturate on integer overflow

Select the overflow mode for fixed-point operations. See “Precision and Range”. The sine table values do not obey this parameter; instead, they are always saturated.

Sine table data type

Choose how you specify the word length of the values of the sine table. The fraction length of the sine table values always equals the word length minus one. You can set this parameter to:

- A rule that inherits a data type, for example, `Inherit: Same word length as input`
- An expression that evaluates to a valid data type, for example, `fixdt(1,16)`

The sine table values do not obey the **Rounding mode** and **Saturate on integer overflow** parameters; instead, they are always saturated and rounded to Nearest.

Product output data type

Specify the product output data type. See “Fixed-Point Data Types” on page 1-20 and “Multiplication Data Types” for illustrations depicting the use of the product output data type in this block. You can set this parameter to:

- A rule that inherits a data type, for example, `Inherit: Inherit via internal rule`
- An expression that evaluates to a valid data type, for example, `fixdt(1,16,0)`

Click the **Show data type assistant** button  to display the **Data Type Assistant**, which helps you set the **Product output data type** parameter.

See “Specify Data Types Using Data Type Assistant” (Simulink) for more information.

Accumulator data type

Specify the accumulator data type. See “Fixed-Point Data Types” on page 1-20 for illustrations depicting the use of the accumulator data type in this block. You can set this parameter to:

- A rule that inherits a data type, for example, `Inherit: Inherit via internal rule`
- An expression that evaluates to a valid data type, for example, `fixdt(1,16,0)`

Click the **Show data type assistant** button  to display the **Data Type Assistant**, which helps you set the **Accumulator data type** parameter.

See “Specify Data Types Using Data Type Assistant” (Simulink) for more information.

Output data type

Specify the output data type. See “Fixed-Point Data Types” on page 1-20 for illustrations depicting the use of the output data type in this block. You can set this parameter to:

- A rule that inherits a data type, for example, `Inherit: Inherit via internal rule`.

When you select `Inherit: Inherit via internal rule`, the block calculates the output word length and fraction length automatically. The internal rule first calculates an ideal output word length and fraction length using the following equations:

- When you select the **Divide butterfly outputs by two** check box, the ideal output word and fraction lengths are the same as the input word and fraction lengths.
- When you clear the **Divide butterfly outputs by two** check box, the block computes the ideal output word and fraction lengths according to the following equations:

$$WL_{idealoutput} = WL_{input} + \text{floor}(\log_2(FFTlength - 1)) + 1$$

$$FL_{idealoutput} = FL_{input}$$

Using these ideal results, the internal rule then selects word lengths and fraction lengths that are appropriate for your hardware. For more information, see “Inherit via Internal Rule”.

- An expression that evaluates to a valid data type, for example, `fixdt(1, 16, 0)`

Click the **Show data type assistant** button  to display the **Data Type Assistant**, which helps you set the **Output data type** parameter.

See “Specify Data Types Using Data Type Assistant” (Simulink) for more information.

Lock data type settings against change by the fixed-point tools

Select this parameter to prevent the fixed-point tools from overriding the data types you specify on the block mask. For more information, see `fxptdlg`, a reference page on the Fixed-Point Tool in the Simulink® documentation.

Example

Bit-Reversed Order

Two numbers are bit-reversed values of each other when the binary representation of one is the mirror image of the binary representation of the other. For example, in a three-bit system, one and four are bit-reversed values of each other because the three-bit binary representation of one, 001, is the mirror image of the three-bit binary representation of four, 100. The following diagram shows the row indices in linear order. To put them in bit-reversed order

- 1 Translate the indices into their binary representation with the minimum number of bits. In this example, the minimum number of bits is three because the binary representation of 7 is 111.
- 2 Find the mirror image of each binary entry, and write it beside the original binary representation.

- 3 Translate the indices back to their decimal representation.

The row indices now appear in bit-reversed order.

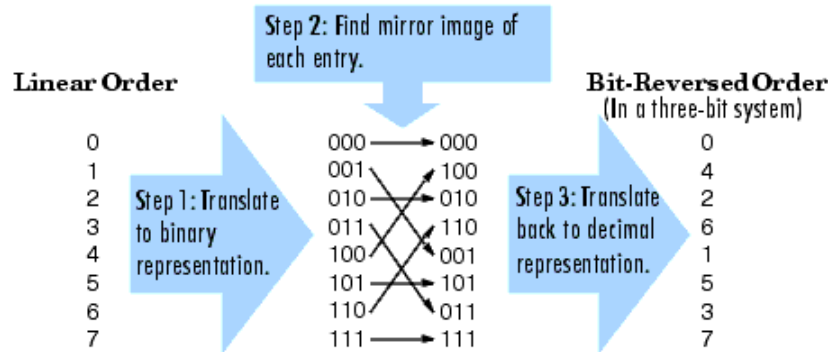

If, on the 2-D FFT block parameters dialog box, you select the **Output in bit-reversed order** check box, the block bit-reverses the order of both the columns and the rows. The next diagram illustrates the linear and bit-reversed outputs of the 2-D FFT block. The output values are the same, but they appear in different order.

245	-13	$10 - 5i$	$10 + 5i$	$13.9 - 0.4i$	$-15.9 - 21.6i$	$-15.9 + 21.6i$	13.9
-9	1	$14 - 31i$	$14 + 31i$	$16.3 + 5.9i$	$17.7 - 23.9i$	$17.7 + 23.9i$	$16.3 - 5.9i$
$18 - 5i$	$6 - 3i$	$19 - 24i$	$5 + 4i$	$-4.3 - 10.4i$	$-5.7 + 16.4i$	$12.4 - 11.4i$	$5.5 + 1.4i$
$18 + 5i$	$6 + 3i$	$5 - 4i$	$19 + 24i$	$5.5 - 1.4i$	$12.5 + 11.3i$	$-5.7 - 16.4i$	$34 + 0.5i$
$-4.3 - 10.3i$	$1.1 - i$	$-5.6 + 13.1i$	$-11.5 - 11i$	$-27.6 - 6.6i$	$-2.6i$	$-3.4 + 8.7i$	$6.2 + 13i$
$8.4 + 2.4i$	$11 + 9i$	$-18.4 - 25.1i$	$-4.5 - 1.1i$	$3.4 - 5.4i$	$17.6 - 9.4i$	$-2.2 + 13i$	$-1 - 2.7i$
$8.4 - 2.4i$	$11 - 9i$	$-4.5 + 1.1i$	$-18.4 + 25.1i$	$-0.6 + 2.7i$	$-2.2 - 13i$	$17.6 + 9.4i$	$34 + 0.5i$
$-4.4 + 10.3i$	$1.1 + i$	$-11.5 + 11i$	$-5.6 - 13.1$	$6.2 - 13i$	$-3.4 - 8.7i$	$2.6i$	$-27.6 + 6.6i$

References

[1] FFTW (<http://www.fftw.org>)

[2] Frigo, M. and S. G. Johnson, "FFTW: An Adaptive Software Architecture for the FFT," *Proceedings of the International Conference on Acoustics, Speech, and Signal Processing*, Vol. 3, 1998, pp. 1381-1384.

See Also

2-D DCT	Computer Vision Toolbox software
2-D IDCT	Computer Vision Toolbox software
2-D IFFT	Computer Vision Toolbox software
2-D IFFT	Computer Vision Toolbox software
bitrevorder	Signal Processing Toolbox software
fft	MATLAB

ifft	MATLAB
"Simulink Coder"	Simulink Coder™

Extended Capabilities

C/C++ Code Generation

Generate C and C++ code using Simulink® Coder™.

Usage notes and limitations:

- When the following conditions apply, the executable generated from this block relies on prebuilt dynamic library files (.dll files) included with MATLAB:
 - **FFT implementation** is set to FFTW.
 - **Inherit FFT length from input dimensions** is cleared, and **FFT length** is set to a value that is not a power of two.

Use the `packNGo` function to package the code generated from this block and all the relevant files in a compressed zip file. Using this zip file, you can relocate, unpack, and rebuild your project in another development environment where MATLAB is not installed. For more details, see .

- When the FFT length is a power of two, you can generate standalone C and C++ code from this block.

Introduced before R2006a

2-D FIR Filter

Perform 2-D FIR filtering on input matrix

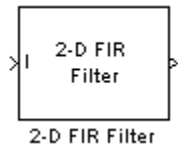

Library

Filtering

visionfilter

Description

The 2-D Finite Impulse Response (FIR) filter block filters the input matrix **I** using the coefficient matrix **H** or the coefficient vectors **HH** and **HV**.

Port	Input/Output	Supported Data Types	Complex Values Supported
I	Vector or matrix of intensity values	<ul style="list-style-type: none"> • Double-precision floating point • Single-precision floating point • Fixed point • 8-, 16-, 32-bit signed integer • 8-, 16-, 32-bit unsigned integer 	Yes
H	Matrix of filter coefficients	Same as I port.	Yes
HH	Vector of filter coefficients	Same as I port. The input to ports HH and HV must be the same data type.	Yes
HV	Vector of filter coefficients	Same as I port. The input to ports HH and HV must be the same data type.	Yes
PVal	Scalar value that represents the constant pad value	Input must have the same data type as the input to I port.	Yes
Output	Scalar, vector, or matrix of filtered values	Same as I port.	Yes

If the input has a floating-point data type, then the output uses the same data type. Otherwise, the output can be any fixed-point data type.

Select the **Separable filter coefficients** check box if your filter coefficients are separable. Using separable filter coefficients reduces the amount of calculations the block must perform to compute the output. For example, suppose your input image is M -by- N and your filter coefficient matrix is x -by- y . For a nonseparable filter with the **Output size** parameter set to Same as input port I, it would take

$$x \cdot y \cdot M \cdot N$$

multiply-accumulate (MAC) operations for the block to calculate the output. For a separable filter, it would only take

$$(x + y) \cdot M \cdot N$$

MAC operations. If you do not know whether or not your filter coefficients are separable, use the `isfilterseparable` function.

Here is an example of the function syntax, `[S, HCOL, HROW] = isfilterseparable(H)`. The `isfilterseparable` function takes the filter kernel, `H`, and returns `S`, `HCOL` and `HROW`. Here, `S` is a Boolean variable that is 1 if the filter is separable and 0 if it is not. `HCOL` is a vector of vertical filter coefficients, and `HROW` is a vector of horizontal filter coefficients.

Use the **Coefficient source** parameter to specify how to define your filter coefficients. If you select the **Separable filter coefficients** check box and then select a **Coefficient source** of `Specify via dialog`, the **Vertical coefficients (across height)** and **Horizontal coefficients (across width)** parameters appear in the dialog box. You can use these parameters to enter vectors of vertical and horizontal filter coefficients, respectively.

You can also use the variables `HCOL` and `HROW`, the output of the `isfilterseparable` function, for these parameters. If you select the **Separable filter coefficients** check box and then select a **Coefficient source** of `Input port`, ports `HV` and `HH` appear on the block. Use these ports to specify vectors of vertical and horizontal filter coefficients.

If you clear the **Separable filter coefficients** check box and select a **Coefficient source** of `Specify via dialog`, the **Coefficients** parameter appears in the dialog box. Use this parameter to enter your matrix of filter coefficients.

If you clear the **Separable filter coefficients** check box and select a **Coefficient source** of `Input port`, port `H` appears on the block. Use this port to specify your filter coefficient matrix.

The block outputs the result of the filtering operation at the Output port. The **Output size** parameter and the sizes of the inputs at ports `I` and `H` dictate the dimensions of the output. For example, assume that the input at port `I` has dimensions (M_i, N_i) and the input at port `H` has dimensions (M_h, N_h) . If you select an **Output size** of `Full`, the output has dimensions $(M_i + M_h - 1, N_i + N_h - 1)$. If you select an **Output size** of `Same as input port I`, the output has the same dimensions as the input at port `I`. If you select an **Output size** of `Valid`, the block filters the input image only where the coefficient matrix fits entirely within it, so no padding is required. The output has dimensions $(M_i - M_h + 1, N_i - N_h + 1)$. However, if `all(size(I) < size(H))`, the block errors out.

Use the **Padding options** parameter to specify how to pad the boundary of your input matrix. To pad your matrix with a constant value, select `Constant`. To pad your input matrix by repeating its border values, select `Replicate`. To pad your input matrix with its mirror image, select `Symmetric`. To pad your input matrix using a circular repetition of its elements, select `Circular`. For more information on padding, see the Image Pad block reference page.

If, for the **Padding options** parameter, you select `Constant`, the **Pad value source** parameter appears in the dialog box. If you select `Specify via dialog`, the **Pad value** parameter appears in the dialog box. Use this parameter to enter the constant value with which to pad your matrix. If you select **Pad value source** of `Input port`, the `PVal` port appears on the block. Use this port to specify the constant value with which to pad your matrix. The pad value must be real if the input image is real. You will get an error message if the pad value is complex when the input image is real.

Use the **Filtering based on** parameter to specify the algorithm by which the block filters the input matrix. If you select **Convolution** and set the **Output size** parameter to **Full**, the block filters your input using the following algorithm

$$C(i, j) = \sum_{m=0}^{(Ma-1)} \sum_{n=0}^{(Na-1)} A(m, n) * H(i-m, j-n)$$

where $0 \leq i < Ma + Mh - 1$ and $0 \leq j < Na + Nh - 1$. If you select **Correlation** and set the **Output size** parameter to **Full**, the block filters your input using the following algorithm

$$C(i, j) = \sum_{m=0}^{(Ma-1)} \sum_{n=0}^{(Na-1)} A(m, n) \cdot \text{conj}(H(m+i, n+j))$$

where $0 \leq i < Ma + Mh - 1$ and $0 \leq j < Na + Nh - 1$.

The `imfilter` function from the Image Processing Toolbox™ product similarly performs N-D filtering of multidimensional images.

Fixed-Point Data Types

The following diagram shows the data types used in the 2-D FIR Filter block for fixed-point signals.

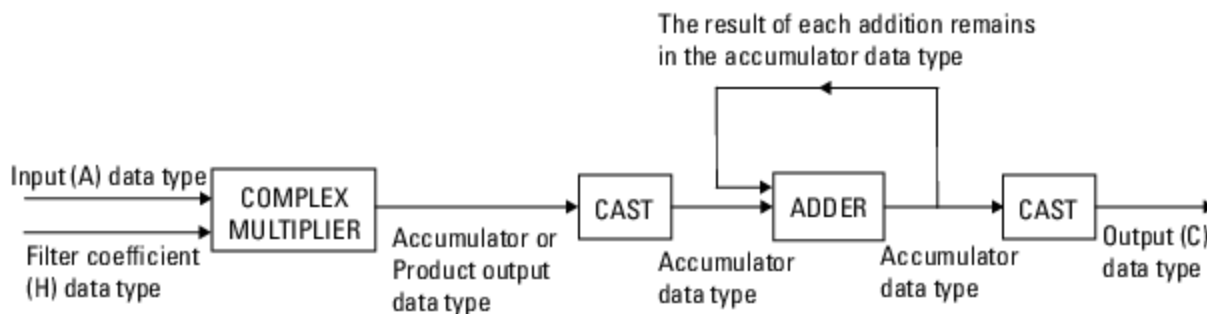

You can set the coefficient, product output, accumulator, and output data types in the block mask as discussed in "Parameters" on page 1-28.

The output of the multiplier is in the product output data type if at least one of the inputs to the multiplier is real. If both of the inputs to the multiplier are complex, the result of the multiplication is in the accumulator data type. For details on the complex multiplication performed, refer to "Multiplication Data Types".

Parameters

Separable filter coefficients

Select this check box if your filter coefficients are separable. Using separable filter coefficients reduces the amount of calculations the block must perform to compute the output.

Coefficient source

Specify how to define your filter coefficients. Select **Specify via dialog** to enter your coefficients in the block parameters dialog box. Select **Input port** to specify your filter coefficient matrix using port H or ports HH and HV.

Coefficients

Enter your real or complex-valued filter coefficient matrix. This parameter appears if you clear the **Separable filter coefficients** check box and then select a **Coefficient source** of Specify via dialog. Tunable.

Vertical coefficients (across height)

Enter the vector of vertical filter coefficients for your separable filter. This parameter appears if you select the **Separable filter coefficients** check box and then select a **Coefficient source** of Specify via dialog.

Horizontal coefficients (across width)

Enter the vector of horizontal filter coefficients for your separable filter. This parameter appears if you select the **Separable filter coefficients** check box and then select a **Coefficient source** of Specify via dialog.

Output size

This parameter controls the size of the filtered output. If you choose **Full**, the output has dimensions $(Ma+Mh-1, Na+Nh-1)$. If you choose **Same as input port I**, the output has the same dimensions as the input at port I. If you choose **Valid**, output has dimensions $(Ma-Mh+1, Na-Nh+1)$.

Padding options

Specify how to pad the boundary of your input matrix. Select **Constant** to pad your matrix with a constant value. Select **Replicate** to pad your input matrix by repeating its border values. Select **Symmetric** to pad your input matrix with its mirror image. Select **Circular** to pad your input matrix using a circular repetition of its elements. This parameter appears if you select an **Output size** of **Full** or **Same as input port I**.

Pad value source

Use this parameter to specify how to define your constant boundary value. Select **Specify via dialog** to enter your value in the block parameters dialog box. Select **Input port** to specify your constant value using the PVal port. This parameter appears if you select a **Padding options** of **Constant**.

Pad value

Enter the constant value with which to pad your matrix. This parameter is visible if, for the **Pad value source** parameter, you select **Specify via dialog**. Tunable. The pad value must be real if the input image is real. You will get an error message if the pad value is complex when the input image is real.

Filtering based on

Specify the algorithm by which the block filters the input matrix. You can select **Convolution** or **Correlation**.

Rounding mode

Select the "Rounding Modes" for fixed-point operations.

Saturate on integer overflow

Select the overflow mode for fixed-point operations. See "Precision and Range".

Coefficients

Choose how to specify the word length and the fraction length of the filter coefficients.

- When you select **Inherit: Same word length as input**, the word length of the filter coefficients match that of the input to the block. In this mode, the block automatically sets the

fraction length of the coefficients to the binary-point only scaling that provides you with the best precision possible given the value and word length of the coefficients.

- When you select `fixdt(1,16)`, you can enter the word length of the coefficients, in bits. In this mode, the block automatically sets the fraction length of the coefficients to the binary-point only scaling that provides you with the best precision possible given the value and word length of the coefficients.
- When you select `fixdt(1,16,0)`, you can enter the word length and the fraction length of the coefficients, in bits.
- When you select `<data type expression>`, you can enter the data type expression.

The filter coefficients do not obey the **Rounding mode** and the **Saturate on integer overflow** parameters; instead, they are always saturated and rounded to Nearest.

Click the **Show data type assistant** button  to display the **Data Type Assistant**, which helps you set the **Product output data type** parameter.

See “Specify Data Types Using Data Type Assistant” (Simulink) for more information.

Product output

Use this parameter to specify how to designate the product output word and fraction lengths. Refer to “Fixed-Point Data Types” on page 1-28 and “Multiplication Data Types” for illustrations depicting the use of the product output data type in this block:

- When you select `Inherit: Same as input`, these characteristics match those of the input to the block.
- When you select `fixdt([],16,0)`, you can enter the word length and the fraction length of the product output, in bits.
- When you select `<data type expression>`, you can enter the data type expression.

If you set the **Coefficient source** (on the **Main** tab) to `Input port` the Product Output will inherit its sign according to the inputs. If either or both input **I1** and **I2** are signed, the Product Output will be signed. Otherwise, the Product Output is unsigned. The following table shows all cases.

Sign of Input I1	Sign of Input I2	Sign of Product Output
unsigned	unsigned	unsigned
unsigned	signed	signed
signed	unsigned	signed
signed	signed	signed

Click the **Show data type assistant** button  to display the **Data Type Assistant**, which helps you set the **Product output data type** parameter.

See “Specify Data Types Using Data Type Assistant” (Simulink) for more information.

Accumulator

Use this parameter to specify how to designate the accumulator word and fraction lengths. Refer to “Fixed-Point Data Types” on page 1-28 and “Multiplication Data Types” for illustrations

depicting the use of the accumulator data type in this block. The accumulator data type is only used when both inputs to the multiplier are complex:

- When you select `Inherit: Same as input`, these characteristics match those of the input to the block.
- When you select `Inherit: Same as product output`, these characteristics match those of the product output.
- When you select `fixdt([], 16, 0)`, you can enter the word length and the fraction length of the accumulator, in bits.
- When you select `Slope and bias scaling`, you can enter the word length, in bits, and the slope of the accumulator. All signals in the Computer Vision Toolbox software have a bias of 0.

Click the **Show data type assistant** button  to display the **Data Type Assistant**, which helps you set the **Product output data type** parameter.

See “Specify Data Types Using Data Type Assistant” (Simulink) for more information.

Output

Choose how to specify the word length and fraction length of the output of the block:

- When you select `Inherit: Same as input`, these characteristics match those of the input to the block.
- When you select `fixdt([], 16, 0)`, you can enter the word length and the fraction length of the output, in bits.

You can choose to set signedness of the output to `Auto`, `Signed` or `Unsigned`.

- When you select `<data type expression>`, you can enter the a data type expression.

Click the **Show data type assistant** button  to display the **Data Type Assistant**, which helps you set the **Product output data type** parameter.

See “Specify Data Types Using Data Type Assistant” (Simulink) for more information.

Lock data type settings against change by the fixed-point tools

Select this parameter to prevent the fixed-point tools from overriding the data types you specify on the block mask. For more information, see `fxptdlg`, a reference page on the Fixed-Point Tool in the Simulink documentation.

See Also

<code>imfilter</code>	Image Processing Toolbox
-----------------------	--------------------------

Extended Capabilities

C/C++ Code Generation

Generate C and C++ code using Simulink® Coder™.

See Also

Topics

“Periodic Noise Reduction”

“Video Stabilization”

Introduced before R2006a

2-D Histogram

Generate histogram from input

Library: Computer Vision Toolbox / Statistics

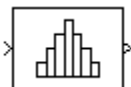

Description

The 2-D Histogram block computes the frequencies of the elements in the input image. The block calculates the histogram values for either the entire input or for each column of the input image. It sorts all the of input values into bins according to their pixel values. The histogram value for a given bin represents the frequency of the input values bracketed by that bin. The block is also capable of computing a running histogram across a sequence of inputs. The block is also capable of computing a running histogram across a sequence of inputs.

Ports

Input

Port_1 — Input image

vector | matrix | 3-D array

Input image, specified as a vector, matrix, or 3-D array.

Data Types: single | double | int8 | int16 | int32 | uint8 | uint16 | uint32 | fixed point

Rst — Reset value

scalar

Reset value for an input sequence, specified as a scalar. This value dictates the event that causes the block to reset the running histogram. The sample time of the **Rst** input must be a positive integer and a multiple of the input sample time.

Dependencies

To enable this port, select the **Running histogram** parameter and set the **Trigger type** parameter to Rising edge, Falling edge, Either edge, or Non-zero sample.

Data Types: single | double | int8 | int16 | int32 | uint8 | uint16 | uint32 | Boolean | fixed point

Output

Port_1 — Histogram output

vector | matrix | 3-D array

Histogram output, returned as a vector, matrix, or 3-D array.

If the **Find the histogram over** parameter is set to Entire input, then the output is always a vector. If the **Find the histogram over** parameter is set to Each column, then the output has the same number of dimension as the input.

Data Types: `single` | `double` | `uint32`

Parameters

Main

Lower limit of histogram — Lower limit of lowest-valued bin

0 (default) | real-valued scalar

Specify a real-valued scalar for the lower boundary, B_m , of the lowest-valued bin. NaN and `inf` are not valid values for B_m .

Tunable: Yes

Upper limit of histogram — Upper limit of highest-valued bin

1 (default) | real-valued scalar

Specify a real-valued scalar for the upper boundary, B_M , of the highest-valued bin. NaN and `inf` are not valid values for B_M .

Tunable: Yes

Number of bins — Number of bins in histogram

256 (default) | real-valued scalar

Specify the number of bins in the histogram.

Find the histogram over — Dimension along which to compute histogram

Entire input (default) | Each column

Specify the dimension of the input image along which the block computes the histogram values. For any given value, n , of the **Number of bins** parameter, this parameter affects the output of the block as follows.

- `Entire input` — The block computes the histogram over the entire input. It outputs an n -element column vector.
- `Each column` — The block computes the histogram over each column of the input.
 - If the input is an M -by- N matrix, the block outputs an n -by- N matrix. The j th column of the output matrix contains the histogram for the data in the j th column of the M -by- N input matrix.
 - If the input is an M -by- N -by- P array, the block outputs an n -by- N -by- P array. If the input is a three-channel color image, the value of P is 3, and the block computes the histogram for each color channel separately.

Normalized — Normalize histogram output

off (default) | on

Select the **Normalized** parameter to normalize the output histogram value within a range of [0, 1].

Note Use of this parameter is not supported for fixed-point signals.

Running histogram — Frequency distribution for successive inputs

off (default) | on

Select the **Running histogram** parameter to compute the frequency distribution of both the past and present data for successive inputs. The block resets the histogram (by emptying all of the bins) when it detects a reset event at the optional **Rst** port. There's an additional dimension to the output size which is equal to $((T_{sim}/T_s)+1)$ where T_{sim} is the simulation time and T_s is the sample time for block execution. The output depends on the value of the **Find the histogram over** parameter.

- **Entire input** — The block computes a running histogram for the data in the first dimension of the input. The block outputs an n -by-1-by- $((T_{sim}/T_s)+1)$, where n is the value of **Number of bins** parameter.
- **Each column** — The block computes a running histogram for each column of the M -by- N matrix. The block outputs an n -by- N -by- $((T_{sim}/T_s)+1)$ array, where n is the value of the **Number of bins** parameter.

Note When the block is used in running mode and the input data type is non-floating point, the output of the histogram is stored as a `uint32` data type. The largest number that can be represented by this data type is $2^{32}-1$. If the range of the `uint32` data type is exceeded, the output data wraps back to 0.

Trigger type — Reset condition of running histogram

None (default) | Rising edge | Falling edge | Either edge | Non-zero sample

Specify the event that, when detected at the optional **Rst** port, resets the running histogram. The reset signal and the input data signal must have the same rate.

Specify the reset event as:

- **None** — Disables the **Rst** port
- **Rising edge** — Triggers a reset event when the **Rst** input does one of the following:
 - Rises from a negative value to either a positive value or zero
 - Rises from zero to a positive value, where the rise is not a continuation of a rise from a negative value to zero

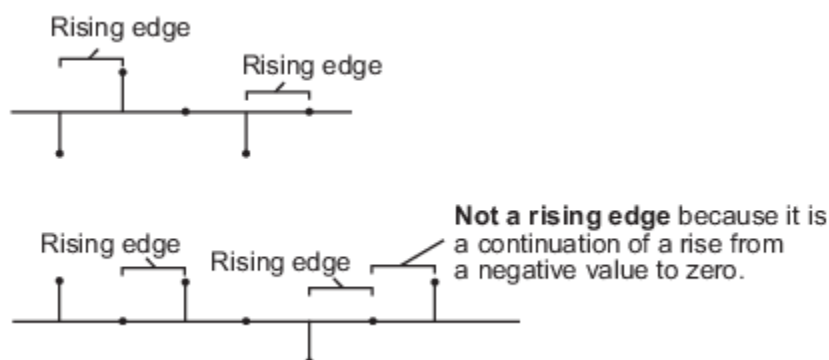

- **Falling edge** — Triggers a reset event when the **Rst** input does one of the following:
 - Falls from a positive value to either a negative value or zero
 - Falls from zero to a negative value, where the fall is not a continuation of a fall from a positive value to zero

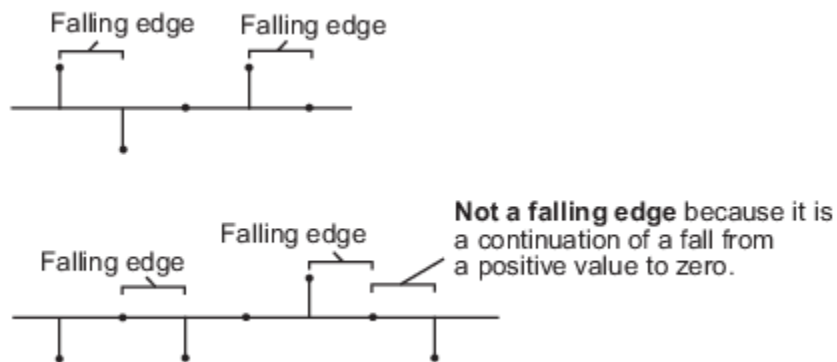

- **Either edge** — Triggers a reset event when the **Rst** input is a rising edge or falling edge
- **Non-zero sample** — Triggers a reset event at each sample time that the **Rst** input is not zero

Dependencies

To enable this parameter, select the **Running histogram** parameter.

Data Types

For details on the fixed-point block parameters, see “Specify Fixed-Point Attributes for Blocks”.

Lock data type settings against change by the fixed-point tools — Prevent fixed-point tools from overriding data types

off (default) | on

Select this parameter to prevent the fixed-point tools from overriding the data types you specify in this block. For more information, see “Lock the Output Data Type Setting” (Fixed-Point Designer).

Block Characteristics

Data Types	double fixed point integer single
Multidimensional Signals	no
Variable-Size Signals	no

Algorithms

The histogram bins have equal width of:

$$\Delta = \frac{B_M - B_m}{n},$$

where

- B_M — Represents the upper boundary of the highest-valued bin.
- B_m — Represents the lower boundary of the lowest-valued bin.
- n — Represents the number of bins.

The centers are located at:

$$B_m + \left(k + \frac{1}{2}\right)\Delta \quad k = 0, 1, 2, \dots, n - 1.$$

For input values that fall between two bins, the block places them in the lower-valued bin. For input values greater than the upper limit of the histogram or less than the lower limit of the histogram, the block places them in the highest-valued or lowest-valued bin, respectively.

Extended Capabilities

C/C++ Code Generation

Generate C and C++ code using Simulink® Coder™.

Generated code relies on `memcpy` or `memset` functions (`string.h`) under certain conditions.

See Also

Functions

`histogram`

Introduced before R2006a

2-D IDCT

Compute 2-D inverse discrete cosine transform (IDCT)

Library: Computer Vision Toolbox / Transforms

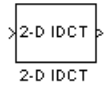

Description

The 2-D IDCT block calculates the two-dimensional inverse discrete cosine transform of the input signal. The equation for the two-dimensional IDCT of an input signal is:

$$f(x, y) = \frac{2}{\sqrt{MN}} \sum_{m=0}^{M-1} \sum_{n=0}^{N-1} C(m)C(n)F(m, n) \cos\left(\frac{(2x+1)m\pi}{2M}\right) \cos\left(\frac{(2y+1)n\pi}{2N}\right),$$

where $F(m, n)$ is the discrete cosine transform (DCT) of the signal $f(x, y)$. If $m = n = 0$, then $C(m) = C(n) = 1/\sqrt{2}$. Otherwise $C(m) = C(n) = 1$.

Ports

Input

Port_1 — Input data

matrix | vector

Specify input data as a vector or matrix of intensity values. The number of elements in the input data must be a power of two.

Data Types: single | double | int8 | int16 | int32 | uint8 | uint16 | uint32 | fixed point

Output

Port_1 — Output data

matrix | vector

Output data containing the 2-D IDCT of the input, returned as a matrix or vector. The size and data type of the output are the same as those of the input.

Data Types: single | double | int8 | int16 | int32 | uint8 | uint16 | uint32 | fixed point

Parameters

Main

Sine and cosine computation — How the block computes sine and cosine terms

Table lookup (default) | Trigonometric fcn

Specify how the block computes the sine and cosine terms to find the 2-D IDCT.

- **Table lookup** — The block computes and stores the trigonometric values before the simulation starts. This option requires more memory than the `Trigonometric fcn` option.

- **Trigonometric fcn** — The block computes the sine and cosine values during the simulation.

Data Types

For details on the fixed-point block parameters, see “Specify Fixed-Point Attributes for Blocks”.

Lock data type settings against change by the fixed-point tools — Data type override

off (default) | on

Select this parameter to prevent the fixed-point tools from overriding the data types you specify in this block. For more information, see “Lock the Output Data Type Setting” (Fixed-Point Designer).

Block Characteristics

Data Types	double fixed point integer single
Multidimensional Signals	no
Variable-Size Signals	no

More About

Fixed-Point Data Types

The following diagram shows the data types used in the 2-D IDCT block for fixed-point signals. Inputs are first cast to the output data type and stored in the output buffer. Each butterfly stage processes signals in the accumulator data type, with the final output of the butterfly being cast back into the output data type.

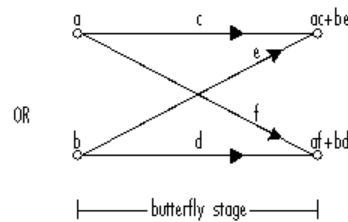
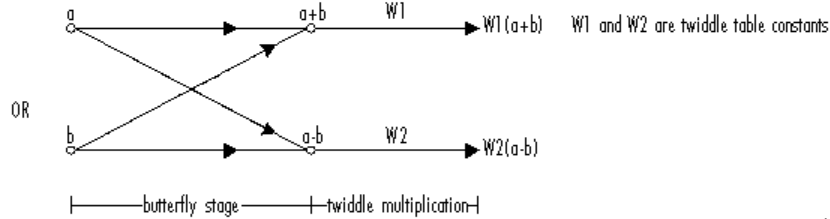
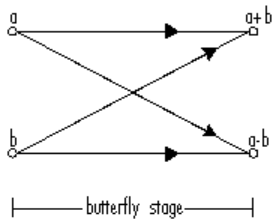

Butterfly Stage Data Types

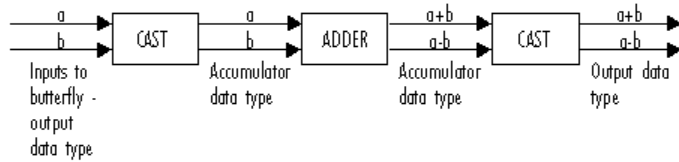

Twiddle Multiplication Data Types

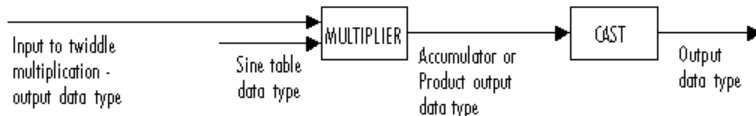

When at least one of the inputs to the multiplier is real, the output of the multiplier is in the product output data type. When both of the inputs to the multiplier are complex, the multiplication result is in the accumulator data type. For more information on the multiplication of real and complex numbers, see “Multiplication Data Types”.

References

[1] Wen-Hsiung Chen, C. Smith, and S. Fralick. “A Fast Computational Algorithm for the Discrete Cosine Transform.” *IEEE Transactions on Communications* 25, no. 9 (September 1977): 1004–9. <https://doi.org/10.1109/TCOM.1977.1093941>.

[2] Zhongde Wang. “Fast Algorithms for the Discrete W Transform and for the Discrete Fourier Transform.” *IEEE Transactions on Acoustics, Speech, and Signal Processing* 32, no. 4 (August 1984): 803–16. <https://doi.org/10.1109/TASSP.1984.1164399>.

Extended Capabilities

C/C++ Code Generation

Generate C and C++ code using Simulink® Coder™.

See Also

Blocks

2-D DCT | 2-D FFT | 2-D IFFT

Functions

dct2 | idct2

Introduced before R2006a

2-D IFFT

2-D Inverse fast Fourier transform of input

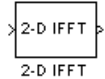

Library

Transforms

visiontransforms

Description

The 2-D IFFT block computes the inverse fast Fourier transform (IFFT) of an M -by- N input matrix in two steps. First, it computes the one-dimensional IFFT along one dimension (row or column). Next, it computes the IFFT of the output of the first step along the other dimension (column or row).

The output of the IFFT block is equivalent to the MATLAB `ifft2` function:

```
y = ifft2(A) % Equivalent MATLAB code
```

Computing the IFFT of each dimension of the input matrix is equivalent to calculating the two-dimensional inverse discrete Fourier transform (IDFT), which is defined by the following equation:

$$f(x, y) = \frac{1}{MN} \sum_{m=0}^{M-1} \sum_{n=0}^{N-1} F(m, n) e^{j\frac{2\pi mx}{M}} e^{j\frac{2\pi ny}{N}}$$

where $0 \leq x \leq M - 1$ and $0 \leq y \leq N - 1$.

The output of this block has the same dimensions as the input. If the input signal has a floating-point data type, the data type of the output signal uses the same floating-point data type. Otherwise, the output can be any fixed-point data type. The block computes scaled and unscaled versions of the IFFT.

The input to this block can be floating-point or fixed-point, real or complex, and conjugate symmetric. The block uses one of two possible FFT implementations. You can select an implementation based on the FFTW library [1], [2], or an implementation based on a collection of Radix-2 algorithms. You can select Auto to allow the block to choose the implementation.

Port Description

Port	Description	Supported Data Types	Complex Values Supported
Input	Vector or matrix of intensity values	<ul style="list-style-type: none"> • Double-precision floating point • Single-precision floating point • Fixed point • 8-, 16-, 32-bit signed integer • 8-, 16-, 32-bit unsigned integer 	Yes
Output	2-D IFFT of the input	Same as Input port	Yes

FFTW Implementation

The FFTW implementation provides an optimized FFT calculation including support for power-of-two and non-power-of-two transform lengths in both simulation and code generation. Generated code using the FFTW implementation will be restricted to MATLAB host computers. The data type must be floating-point. Refer to “Simulink Coder” for more details on generating code.

Radix-2 Implementation

The Radix-2 implementation supports bit-reversed processing, fixed or floating-point data, and allows the block to provide portable C-code generation using the “Simulink Coder”. The dimensions of the input matrix, M and N , must be powers of two. To work with other input sizes, use the Image Pad block to pad or truncate these dimensions to powers of two, or if possible choose the FFTW implementation.

With Radix-2 selected, the block implements one or more of the following algorithms:

- Butterfly operation
- Double-signal algorithm
- Half-length algorithm
- Radix-2 decimation-in-time (DIT) algorithm
- Radix-2 decimation-in-frequency (DIF) algorithm

Radix-2 Algorithms for Real or Complex Input Complexity Floating-Point Signals

Parameter Settings	Algorithms Used for IFFT Computation
<input type="checkbox"/> Input is in bit-reversed order <input type="checkbox"/> Input is conjugate symmetric	Butterfly operation and radix-2 DIT
<input checked="" type="checkbox"/> Input is in bit-reversed order <input type="checkbox"/> Input is conjugate symmetric	Radix-2 DIF
<input type="checkbox"/> Input is in bit-reversed order <input checked="" type="checkbox"/> Input is conjugate symmetric	Butterfly operation and radix-2 DIT in conjunction with the half-length and double-signal algorithms
<input checked="" type="checkbox"/> Input is in bit-reversed order <input checked="" type="checkbox"/> Input is conjugate symmetric	Radix-2 DIF in conjunction with the half-length and double-signal algorithms

Radix-2 Algorithms for Real or Complex Input Complexity Fixed-Point Signals

Other Parameter Settings	Algorithms Used for IFFT Computation
<input type="checkbox"/> Input is in bit-reversed order <input type="checkbox"/> Input is conjugate symmetric	Butterfly operation and radix-2 DIT
<input checked="" type="checkbox"/> Input is in bit-reversed order <input type="checkbox"/> Input is conjugate symmetric	Radix-2 DIF

Note The **Input is conjugate symmetric** parameter cannot be used for fixed-point signals.

Radix-2 Optimization for the Table of Trigonometric Values

In certain situations, the block's Radix-2 algorithm computes all the possible trigonometric values of the twiddle factor

$$e^{j\frac{2\pi k}{K}}$$

where K is the greater value of either M or N and $k = 0, \dots, K - 1$. The block stores these values in a table and retrieves them during simulation. The number of table entries for fixed-point and floating-point is summarized in the following table:

Number of Table Entries for N-Point FFT	
floating-point	$3 N/4$
fixed-point	N

Fixed-Point Data Types

The following diagrams show the data types used in the IFFT block for fixed-point signals. You can set the sine table, accumulator, product output, and output data types displayed in the diagrams in the IFFT dialog box as discussed in "Parameters" on page 1-45.

Inputs to the IFFT block are first cast to the output data type and stored in the output buffer. Each butterfly stage then processes signals in the accumulator data type, with the final output of the butterfly being cast back into the output data type. The block multiplies in a twiddle factor before each butterfly stage in a decimation-in-time IFFT and after each butterfly stage in a decimation-in-frequency IFFT.

Decimation-in-time IFFT

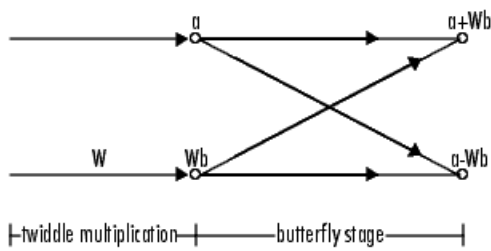

Decimation-in-frequency IFFT

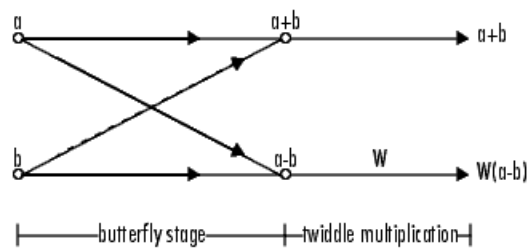

Butterfly stage data types

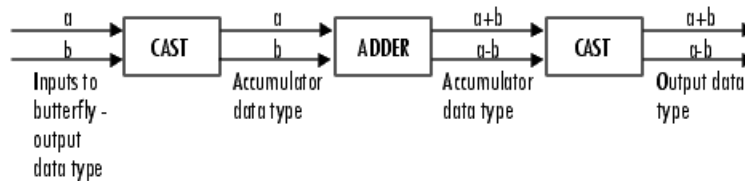

Twiddle multiplication data types



The multiplier output appears in the accumulator data type because both of the inputs to the multiplier are complex. For details on the complex multiplication performed, refer to “Multiplication Data Types”.

Parameters

FFT implementation

Set this parameter to FFTW [1], [2] to support an arbitrary length input signal. The block restricts generated code with FFTW implementation to MATLAB host computers.

Set this parameter to Radix-2 for bit-reversed processing, fixed or floating-point data, or for portable C-code generation using the “Simulink Coder”. The dimensions of the input matrix, M and N , must be powers of two. To work with other input sizes, use the Image Pad block to pad or truncate these dimensions to powers of two, or if possible choose the FFTW implementation. See “Radix-2 Implementation” on page 1-43.

Set this parameter to Auto to let the block choose the FFT implementation. For non-power-of-two transform lengths, the block restricts generated code to MATLAB host computers.

Input is in bit-reversed order

Select or clear this check box to designate the order of the input channel elements. Select this check box when the input should appear in reversed order, and clear it when the input should appear in linear order. The block yields invalid outputs when you do not set this parameter correctly. This check box only appears when you set the **FFT implementation** parameter to Radix-2 or Auto.

For more information ordering of the output, see “Bit-Reversed Order” on page 1-23. The 2-D FFT block bit-reverses the order of both the columns and the rows.

Input is conjugate symmetric

Select this option when the block inputs both floating point and conjugate symmetric, and you want real-valued outputs. This parameter cannot be used for fixed-point signals. Selecting this check box optimizes the block's computation method.

The FFT block yields conjugate symmetric output when you input real-valued data. Taking the IFFT of a conjugate symmetric input matrix produces real-valued output. Therefore, if the input to the block is both floating point and conjugate symmetric, and you select this check box, the block produces real-valued outputs.

If the IFFT block inputs conjugate symmetric data and you do not select this check box, the IFFT block outputs a complex-valued signal with small imaginary parts. The block outputs invalid data if you select this option with non conjugate symmetric input data.

Divide output by product of FFT length in each input dimension

Select this check box to compute the scaled IFFT. The block computes scaled and unscaled versions of the IFFT. If you select this option, the block computes the scaled version of the IFFT. The unscaled IFFT is defined by the following equation:

$$f(x, y) = \sum_{m=0}^{M-1} \sum_{n=0}^{N-1} F(m, n) e^{j\frac{2\pi mx}{M}} e^{j\frac{2\pi ny}{N}}$$

where $0 \leq x \leq M - 1$ and $0 \leq y \leq N - 1$.

The scaled version of the IFFT multiplies the above unscaled version by $\frac{1}{MN}$.

Rounding mode

Select the “Rounding Modes” for fixed-point operations. The sine table values do not obey this parameter; instead, they always round to Nearest.

Saturate on integer overflow

Select the overflow mode for fixed-point operations. See “Precision and Range”. The sine table values do not obey this parameter; instead, they are always saturated.

Sine table data type

Choose how you specify the word length of the values of the sine table. The fraction length of the sine table values always equals the word length minus one. You can set this parameter to:

- A rule that inherits a data type, for example, `Inherit: Same word length as input`
- An expression that evaluates to a valid data type, for example, `fixdt(1, 16)`

The sine table values do not obey the **Rounding mode** and **Saturate on integer overflow** parameters; instead, they are always saturated and rounded to Nearest.

Product output data type

Specify the product output data type. See “Fixed-Point Data Types” on page 1-44 and “Multiplication Data Types” for illustrations depicting the use of the product output data type in this block. You can set this parameter to:

- A rule that inherits a data type, for example, `Inherit: Inherit via internal rule`
- An expression that evaluates to a valid data type, for example, `fixdt(1,16,0)`

Click the **Show data type assistant** button  to display the **Data Type Assistant**, which helps you set the **Product output data type** parameter.

See “Specify Data Types Using Data Type Assistant” (Simulink) for more information.

Accumulator data type

Specify the accumulator data type. See “Fixed-Point Data Types” on page 1-44 for illustrations depicting the use of the accumulator data type in this block. You can set this parameter to:

- A rule that inherits a data type, for example, `Inherit: Inherit via internal rule`
- An expression that evaluates to a valid data type, for example, `fixdt(1,16,0)`

Click the **Show data type assistant** button  to display the **Data Type Assistant**, which helps you set the **Accumulator data type** parameter.

See “Specify Data Types Using Data Type Assistant” (Simulink) for more information.

Output data type

Specify the output data type. See “Fixed-Point Data Types” on page 1-44 for illustrations depicting the use of the output data type in this block. You can set this parameter to:

- A rule that inherits a data type, for example, `Inherit: Inherit via internal rule`.

When you select `Inherit: Inherit via internal rule`, the block calculates the output word length and fraction length automatically. The internal rule first calculates an ideal output word length and fraction length using the following equations:

- When you select the **Divide butterfly outputs by two** check box, the ideal output word and fraction lengths are the same as the input word and fraction lengths.
- When you clear the **Divide butterfly outputs by two** check box, the block computes the ideal output word and fraction lengths according to the following equations:

$$WL_{idealoutput} = WL_{input} + \text{floor}(\log_2(FFTlength - 1)) + 1$$

$$FL_{idealoutput} = FL_{input}$$

Using these ideal results, the internal rule then selects word lengths and fraction lengths that are appropriate for your hardware. For more information, see “Inherit via Internal Rule”.

- An expression that evaluates to a valid data type, for example, `fixdt(1,16,0)`

Click the **Show data type assistant** button  to display the **Data Type Assistant**, which helps you set the **Output data type** parameter.

See “Specify Data Types Using Data Type Assistant” (Simulink) for more information.

Lock data type settings against change by the fixed-point tools

Select this parameter to prevent the fixed-point tools from overriding the data types you specify on the block mask. For more information, see `fxptdlg`, a reference page on the Fixed-Point Tool in the Simulink documentation.

References

[1] FFTW (<http://www.fftw.org>)

[2] Frigo, M. and S. G. Johnson, “FFTW: An Adaptive Software Architecture for the FFT,” *Proceedings of the International Conference on Acoustics, Speech, and Signal Processing*, Vol. 3, 1998, pp. 1381-1384.

See Also

2-D DCT	Computer Vision Toolbox software
2-D FFT	Computer Vision Toolbox software
2-D IDCT	Computer Vision Toolbox software
2-D FFT	Computer Vision Toolbox software
<code>bitrevorder</code>	Signal Processing Toolbox software
<code>fft</code>	MATLAB
<code>ifft</code>	MATLAB
“Simulink Coder”	Simulink

Extended Capabilities

C/C++ Code Generation

Generate C and C++ code using Simulink® Coder™.

Usage notes and limitations:

- When the following conditions apply, the executable generated from this block relies on prebuilt dynamic library files (`.dll` files) included with MATLAB:
 - **FFT implementation** is set to FFTW.
 - **Inherit FFT length from input dimensions** is cleared, and **FFT length** is set to a value that is not a power of two.

Use the `packNGo` function to package the code generated from this block and all the relevant files in a compressed zip file. Using this zip file, you can relocate, unpack, and rebuild your project in another development environment where MATLAB is not installed. For more details, see .

- When the FFT length is a power of two, you can generate standalone C and C++ code from this block.

Introduced before R2006a

2-D Mean

Find 2-D mean of input array

Library: Computer Vision Toolbox / Statistics

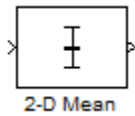

Description

The 2-D Mean block computes the mean value of an input. It can compute the mean either along a specified dimension of the input or across the entire input. The block can also compute the running mean values in a sequence of inputs over a period of time.

Ports

Input

I — Input array

vector | matrix | *N*-D array

Input array, specified as a vector, matrix, or *N*-D array. This port is unnamed unless you select the **Enable ROI processing** parameter or select the **Running mean** parameter and set the **Reset port** parameter to a value other than None.

Data Types: single | double | int8 | int16 | int32 | uint8 | uint16 | uint32 | fixed point
Complex Number Support: Yes

Rst — Reset running mean

scalar

Reset the running mean, specified as a scalar. This port specifies the event that causes the block to reset the running mean. The sample time of the **Rst** input must be a positive integer and a multiple of the block sample time.

Dependencies

To enable this port, select the **Running mean** parameter and set the **Reset port** parameter to one of these options:

- Rising edge
- Falling edge
- Either edge
- Non-zero sample

Data Types: single | double | int8 | int16 | int32 | uint8 | uint16 | uint32 | Boolean

ROI — Region of interest

vector | matrix

Region of interest (ROI), specified as a four-element vector, m -by-4 matrix, or M -by- N matrix. This port accepts different input values depending on the setting of the **ROI type** parameter.

Note The block supports the **ROI** port for 2-D input images only.

Dependencies

To enable this port, select **Enable ROI processing** parameter.

Data Types: `single` | `double` | `int8` | `int16` | `int32` | `uint8` | `uint16` | `uint32` | `Boolean`

Label — Label matrix

matrix

Label matrix, specified as a matrix of nonnegative integers. The label matrix represents the objects in a 2-D image on a per pixel basis. The pixels labeled 0 represent the background, pixels labeled 1 make up the first object, the pixels labeled 2 make up the second object, and so on. The size of the label matrix must be the same as the size of the 2-D input image.

Dependencies

To enable this port, select **Enable ROI processing** parameter and set the **ROI type** parameter to `Label matrix`.

Data Types: `uint8` | `uint16` | `uint32`

Label Numbers — Label values of ROIs

vector

Label values of ROIs, specified as an M -element vector. Use this vector to specify which objects the block calculates statistics for. Each element of the vector must correspond to a labeled object in the label matrix. M must be less than or equal to the number of objects in the label matrix.

Dependencies

To enable this port, select **Enable ROI processing** parameter and set the **ROI type** parameter to `Label matrix`.

Data Types: `uint8` | `uint16` | `uint32`

Output

Out — Mean value of input

scalar | vector | matrix | N -D array

Mean value of the input, returned as a scalar, vector, matrix, or N -D array. The size of this output depends on the size of the input and the parameter settings of the block. This port is unnamed unless you select the **Output flag indicating if ROI is within image bounds** or **Output flag indicating if input label numbers are valid** parameter

Compute Mean Value of Input Array

The block computes the mean value along the specified dimension of the input or across the entire input. The block returns output as:

- **Scalar** — The input is of any size, and the **Find the mean value over** parameter is set to **Entire input**.
- **Vector** — The input is a matrix, and the **Find the mean value over** parameter is set to **Each row**, **Each column**, or **Specified dimension**. If **Specified dimension** is selected, the value of the **Dimension** parameter must be either 1 or 2.
- **(N-1)-D array** — The input is an N -D array, the **Find the mean value over** parameter is set to **Specified dimension**, and the value of the **Dimension** parameter is N .
- **N -D array with one singleton dimension** — The input is an N -D array, and the **Find the mean value over** parameter is set to **Each row**, **Each column**, or **Specified dimension**. If **Specified dimension** is selected, the value of the **Dimension** parameter must be an integer less than N .

Example: For a 3-D input array of size M -by- N -by- P , the dimension of the returned output is:

- An 1-by- N -by- P array if you set the **Find the mean value over** parameter to **Entire row**.
- An M -by-1-by- P array if you set the **Find the mean value over** parameter to **Entire column**.
- An M -by- N matrix if you set the **Find the mean value over** parameter to **Specified dimension** and the **Dimension** parameter to 3.

Compute Mean Value of Sequence of Inputs

Select the **Running mean** parameter. The block finds the mean value of each element of the input across the entire sequence and compiles them into a single array. The output is of the same size as the input.

Data Types: single | double | int8 | int16 | int32 | uint8 | uint16 | uint32 | fixed point

Flag — Validation of ROI

scalar | vector

Validation of ROI, returned as a scalar or vector of logical values. If the **ROI type** parameter is set to **Rectangles** or **Lines**, the output signifies whether or not the specified ROIs lie within the input image, either completely or partially. If the **ROI type** parameter is set to **Label matrix**, the output signifies whether or not the label numbers specified in the **Label Numbers** input are present in the input label matrix. The size of this output depends on whether the **Output** parameter is set to **Individual statistics for each ROI** or **Single statistic for all ROIs**.

ROI type	Individual statistics for each ROI	Single statistic for all ROIs
Rectangles or Lines	The port returns an M -element vector of logical values, where M is the number of regions specified at the ROI port. When an ROI is either completely or partially inside the input image, the corresponding element of the vector is 1. When the ROI is completely outside the input image, the corresponding element of the vector is 0.	The port returns a logical scalar. The scalar is 0 when all the ROIs are completely outside the input image. Otherwise, the scalar is 1.

Label matrix	The port returns an M -element vector of logical values, where M is the number of elements in the input specified at the Label Numbers port. When a specified label number is present or absent in the label matrix, the corresponding element of the vector is 1 or 0 respectively.	The port returns a logical scalar. The scalar is 0 when all elements of the vector specified at the Label Numbers port are absent from the label matrix. Otherwise, the scalar is 1.
--------------	---	---

Note If an ROI is partially outside the image, the block computes the mean values for only the portion of the ROI that lies within the image bounds.

Dependencies

To enable this port, set the **ROI type** parameter to Rectangles, Lines, or Label matrix. For either Rectangles or Lines, select the **Output flag indicating if ROI is within image bounds** parameter. For Label matrix, select the **Output flag indicating if input label numbers are valid** parameter.

Data Types: Boolean

Parameters

Main

Running mean — Running mean values

off (default) | on

Select this parameter to compute running mean values across a sequence of inputs over a period of time.

Reset port — Reset event

None (default) | Rising edge | Falling edge | Either edge | Non-zero sample

Specifies what the block detects as a reset event. The block resets the running mean when a reset event occurs at the **Rst** port. The reset sample time must be a positive integer and a multiple of the input sample time.

Specify the reset event as one of these options.

- None — Disable the **Rst** port.
- Rising edge — Trigger a reset event when the **Rst** input does one of the following.
 - Rises from a negative value to either a positive value or zero
 - Rises from zero to a positive value, where the rise is not a continuation of a rise from a negative value to zero

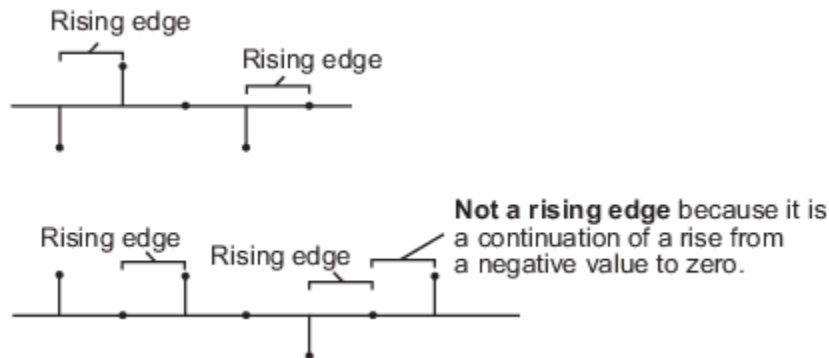

- **Falling edge** — Trigger a reset event when the **Rst** input does one of the following.
 - Falls from a positive value to either a negative value or zero
 - Falls from zero to a negative value, where the fall is not a continuation of a fall from a positive value to zero

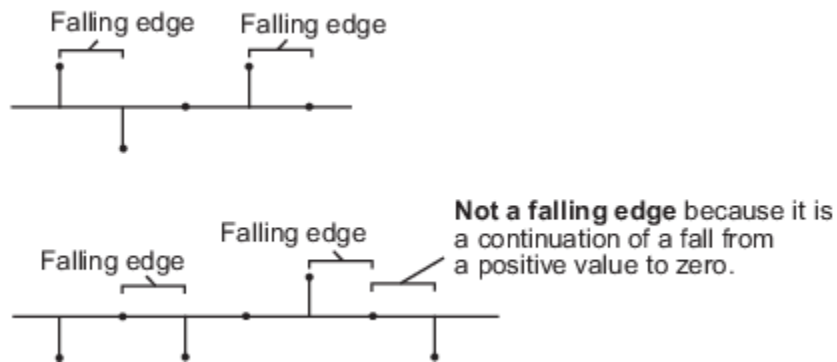

- **Either edge** — Trigger a reset event when the **Rst** input is either a rising edge or a falling edge.
- **Non-zero sample** — Trigger a reset event at each sample time that corresponds to a non-zero **Rst** input.

Note When running simulations in Simulink multitasking mode, reset signals have a one-sample latency. In this case, when the block detects a reset event, there is a one-sample delay at the **Rst** port before the block applies the reset.

Dependencies

To enable this parameter, select the **Running mean** parameter.

Find the mean value over — Dimension along which mean is computed

Entire input (default) | Each row | Each column | Specified dimension

Specify the dimension of the input along which the block computes the mean.

- **Entire input** — Computes mean over the entire input.
- **Each row** — Computes mean over each row.
- **Each column** — Computes mean over each column.
- **Specified dimension** — Computes mean over the dimension specified in the **Dimension** parameter.

- If the **Dimension** parameter is set to 1, the output is the same as when Each column is selected.
- If the **Dimension** parameter is set to 2, the output is the same as when Each row is selected.

Dependencies

To enable this parameter, clear the **Running mean** parameter.

Dimension — Custom dimension

1 (default) | positive scalar

Specify the dimension (one-based value) of the input array over which the block computes the mean. The value of this parameter must not exceed the number of dimensions in the input array.

Dependencies

To enable this parameter, set the **Find the mean value over** parameter to Specified dimension.

Enable ROI processing — Compute mean value within ROI

off (default) | on

Select to compute the mean within the specified ROIs in the image.

Dependencies

To enable this parameter, set the **Find the mean value over** parameter to Entire input.

ROI type — Type of ROI

Rectangles (default) | Lines | Label matrix | Binary mask

Specify the ROI format that represents the regions in the image over which to compute the mean. The type of ROIs can be a rectangles, lines, a label matrix, or a binary mask.

ROI type	Inputs to the ROI Port	Description
Rectangles	<ul style="list-style-type: none"> • Four-element row vector [<i>x</i> <i>y</i> <i>width</i> <i>height</i>] • <i>M</i>-by-4 matrix: $\begin{bmatrix} x_1 & y_1 & width_1 & height_1 \\ x_2 & y_2 & width_2 & height_2 \\ \vdots & \vdots & \vdots & \vdots \\ x_M & y_M & width_M & height_M \end{bmatrix}$ <p>where <i>M</i> is the number of rectangular ROIs. Each row of the matrix corresponds to a different rectangle.</p>	<ul style="list-style-type: none"> • <i>x</i> and <i>y</i> are the one-based coordinates of the upper left corner of the rectangle. • <i>width</i> and <i>height</i> are the width and height, in pixels, of the rectangle. The values of <i>width</i> and <i>height</i> must be greater than zero.

Lines	<ul style="list-style-type: none"> Four-element row vector $[x_1 \ y_1 \ x_2 \ y_2]$ M-by-4 matrix: $\begin{bmatrix} x_{11} & y_{11} & x_{12} & y_{12} \\ x_{21} & y_{21} & x_{22} & y_{22} \\ \vdots & \vdots & \vdots & \vdots \\ x_{M1} & y_{M1} & x_{M2} & y_{M2} \end{bmatrix}$ <p>where M is the number of linear ROIs. Each row of the matrix corresponds to a different line.</p> 	<ul style="list-style-type: none"> x_1 and y_1 are the coordinates of the beginning of the line. x_2 and y_2 are the coordinates of the end of the line.
Label matrix	M -by- N matrix	Matrix of the same size as the input image. The matrix contains label values that represent different objects in an image. The pixels labeled 0 represent the background. The pixels labeled 1 make up one object, the pixels labeled 2 make up a second object, and so on.
Binary mask	M -by- N matrix	Matrix of the same size as the input image. The binary mask classifies image pixels as belonging to either the region of interest or the background. Binary mask values of 1 indicate that the corresponding image pixel belongs to the ROI. Binary mask values of 0 indicate that the corresponding image pixel is part of the background.

Dependencies

To enable this parameter, select the **Enable ROI processing** parameter.

ROI portion to process – Portion of ROI for which to compute mean

Entire ROI (default) | ROI perimeter

Specify the portion of the ROI for which the block computes the 2-D mean.

- Entire ROI — The block computes the mean value over the entire region of the rectangular ROI.
- ROI perimeter — The block computes the mean value along the perimeter of the rectangular ROI.

Dependencies

To enable this parameter, set the **ROI type** parameter to Rectangles.

Output – Compute individual or universal mean for ROIs

Individual statistics for each ROI (default) | Single statistic for all ROIs

Specify whether to calculate the 2-D mean individually for each ROI or across all ROIs.

- To compute separate mean values for each ROI, set this parameter to `Individual statistics for each ROI`. The block outputs a vector of mean values corresponding to different ROIs. The length of the output vector is equal to the number of ROIs.
- To compute the universal mean value across all specified ROIs, set this parameter to `Single statistic for all ROIs`. The block outputs a scalar representing the mean value across all specified ROIs.

Dependencies

To enable this parameter, set the **ROI type** parameter to `Rectangles`, `Lines`, or `Label matrix`.

Output flag indicating if ROI is within image bounds — Enable flag output port
off (default) | on

Select to enable the Flag output port.

Dependencies

To enable this parameter, set the **ROI type** parameter to `Rectangles` or `Lines`.

Output flag indicating if input label numbers are valid — Enable flag output port
off (default) | on

Select to enable the Flag output port.

Dependencies

To enable this parameter, set the **ROI type** parameter to `Label matrix`.

Data Types

For details on the fixed-point block parameters, see “Specify Fixed-Point Attributes for Blocks”.

Lock data type settings against change by the fixed-point tools — Prevent fixed-point tools from overriding data types
off (default) | on

Select this parameter to prevent the fixed-point tools from overriding the data types you specify in this block. For more information, see “Lock the Output Data Type Setting” (Fixed-Point Designer).

Note Floating-point inheritance takes precedence over the data type settings defined on this pane. When inputs are floating point, the block ignores these settings, and all internal data types are floating point.

Block Characteristics

Data Types	double fixed point integer single
Multidimensional Signals	no
Variable-Size Signals	yes

Extended Capabilities

C/C++ Code Generation

Generate C and C++ code using Simulink® Coder™.

See Also

Blocks

2-D Minimum | 2-D Maximum | 2-D Median

Functions

mean

Introduced before R2006a

2-D Median

2-D Median values of input array

Library: Computer Vision Toolbox / Statistics



Description

The 2-D Median block computes the median value of an input array. The median value of an array is calculated by using these steps.

- 1 The values in the matrix are sorted in numeric order.
- 2 To find the median, of an array, A , with a total number of elements, p , where p is:
 - Odd — Median = $A(\text{ceil}(p / 2))$
 - Even — Median = $(A(p / 2) + A((p / 2) + 1)) / 2$

Ports

Input

Port_1 — Input array

scalar | vector | matrix | N -D array

Specify the Input array as a vector, matrix, or N -D array.

Data Types: double | single | int8 | int16 | int32 | uint8 | uint16 | uint32 | fixed point
Complex Number Support: Yes

Output

Port_1 — Output median values

scalar | vector | matrix | N -D array

The median values are returned as scalar, vector, matrix, or N array. The size of the output and how median is calculated depends on the setting of the **Find the median value over** parameter.

- For M -by- N , the input array, the value of the **Find the median value over** parameter determines the output form in this manner.
 - Entire input — The output is the median value of all the elements of the M -by- N input array as a scalar
 - Each row — The output is a M -by-1 column vector, where each element in the vector is the median value of the corresponding row in the input array.
 - Each column — The output is a 1-by- N row vector, where each element in the vector is the median value of the corresponding column in the input array.
 - Specified dimension — If the **Dimension** parameter is set to 1, the output is the same when you select Each column. If the **Dimension** parameter is set to 2, the output is the same

as when you select `Each row`. If the **Dimension** parameter is set to 3, the output at each sample time is an M -by- N matrix containing the median value of each vector over the third dimension of the input

- For an N -D array, the value of the **Find the median value over** parameter determines the output form in this manner.
 - `Entire input` — The output is the median value of all elements of the M -by- N -by- P input array as scalar.
 - `Each row` — The output is a M -by-1-by- P array, where each element contains the median value of each row vector in each plane.
 - `Each column` — The output dimension is a 1-by- N -by- P array, where each element contains the median value of each column vector for each plane.
 - `Specified dimension` — The output depends on **Dimension**. If **Dimension** is set to 1, the output is the same as when you select `Each column`. If **Dimension** is set to 2, the output is the same as when you select `Each row`. If **Dimension** is set to 3, the output dimension is a M -by- N matrix containing the median value of each vector over the third dimension of the input

Data Types: `single` | `double` | `int8` | `int16` | `int32` | `uint8` | `uint16` | `uint32` | `fixed point`

Parameters

Main

Sort algorithm — Algorithm to sort input array

`Quick sort` (default) | `Insertion sort`

Specify the algorithm by which to sort the input array.

- `Quick sort` — This sorting algorithm uses a recursive sort method and is faster at sorting more than 32 elements.
- `Insertion sort` — This sorting algorithm uses a non-recursive method and is faster at sorting fewer than 32 elements.

When you generate code, to avoid recursive function calls, use the `Insertion sort` algorithm.

Find the median value over — Dimension in which to compute median

`Entire input` (default) | `Each row` | `Each column` | `Specified dimension`

Specify the dimension of the input in which the block computes the median.

- `Entire input` — Computes the median over the entire input. The output value is scalar
- `Each row` — Computes the median over each row of the input. The output is column vector
- `Each column` — Computes the median over each column of the input. The output is row vector
- `Specified dimension` — Computes the median over the dimension of the input specified in the **Dimension** parameter.
 - If **Dimension** is 1, the output is the same as when you select `Each column`
 - If **Dimension** is 2, the output is the same as when you select `Each row`

Dimension — Custom dimension

1 (default) | positive scalar

Specify the dimension (one-based value) of the input array, over which the block computes the median. The value of this parameter must not exceed the number of dimensions in the input array.

Dependencies

To enable this parameter, set the **Find the median value over** parameter to **Specified dimension**.

Data Types Tab

For details on the fixed-point block parameters, see “Specify Fixed-Point Attributes for Blocks”.

Lock data type settings against change by the fixed-point tools — Option to prevent fixed-point tools from overriding data types

off (default) | on

Select this parameter to prevent the fixed-point tools from overriding the data types you specify in this block. For more information, see “Lock the Output Data Type Setting” (Fixed-Point Designer).

Note Floating-point inheritance takes precedence over the data type settings defined on this pane. When inputs are floating point, the block ignores these settings, and all internal data types are floating point.

Block Characteristics

Data Types	double fixed point integer single
Multidimensional Signals	no
Variable-Size Signals	yes

Extended Capabilities

C/C++ Code Generation

Generate C and C++ code using Simulink® Coder™.

Generated code relies on `memcpy` or `memset` functions (`string.h`) under certain conditions.

See Also

Blocks

2-D Variance | 2-D Minimum | 2-D Maximum | 2-D Mean | 2-D Standard Deviation

Functions

median

Introduced before R2006a

2-D Maximum

Compute maximum value of input or sequence of inputs

Library: Computer Vision Toolbox / Statistics

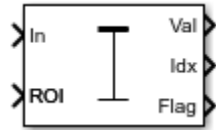

Description

The 2-D Maximum block identifies the index of the largest element in an input array. The input can be a 1-D vector, 2-D matrix, or an N -D-array. The block can compute the maximum value along a specified dimension of the input or the entire input. The 2-D Maximum block can also track the maximum values in a sequence of inputs over a period of time.

Ports

Input

In — Input array

vector | matrix | N -D- array

Input array, specified as a vector, matrix, or N -D- array. This port is unnamed until you select the **Enable ROI processing** parameter or set the **Mode** parameter to **Running**.

Data Types: single | double | int8 | int16 | int32 | int64 | uint8 | uint16 | uint32 | uint64 | Boolean | fixed point

Complex Number Support: Yes

Rst — Reset port

scalar

Reset port, specified as a scalar. This port specifies the event that causes the block to reset the running maximum. The sample time of the **Rst** input must be a positive integer and a multiple of the input sample time.

Dependencies

To enable this port, set the **Mode** parameter to **Running** and set the **Reset port** parameter to **Rising edge**, **Falling edge**, **Either edge**, or **Non-zero sample**.

Data Types: single | double | int8 | int16 | int32 | uint8 | uint16 | uint32 | Boolean

ROI — Region of interest

four-element vector | m -by-4 matrix | M -by- N matrix

Region of interest (ROI), specified as a four-element vector, m -by-4 matrix, or M -by- N matrix. The input value to this port depends on the **ROI type** parameter.

Note You can use the ROI port only if the input is a matrix.

Dependencies

To enable this port, set the **Find the maximum value over** parameter to `Entire` input and select the **Enable ROI processing** parameter.

Data Types: `single` | `double` | `int8` | `int16` | `int32` | `uint8` | `uint16` | `uint32`

Label — Label matrix

matrix of nonnegative integers

Label matrix, specified as a matrix of nonnegative integers. The label matrix represents the objects in an image. The pixels labeled 0 are the background. The pixels labeled 1 make up one object; the pixels labeled 2 make up a second object; and so on. The size of the label matrix must be the same size as the 2-D input.

Dependencies

To enable this port, select the **Enable ROI processing** parameter and set the **ROI type** parameter to `Label matrix`.

Data Types: `uint8` | `uint16` | `uint32`

Label Numbers — Label values of ROIs

M-element vector

Label values of ROIs, specified as a *M*-element vector. The value of *M* can be less than or equal to the number of objects that are labeled in the label matrix.

Dependencies

To enable this port, select the **Enable ROI processing** parameter and set the **ROI type** parameter to `Label matrix`.

Data Types: `uint8` | `uint16` | `uint32`

Output

Val — Output maximum value

scalar | vector | matrix | *N-D*-array

Output maximum value, returned as a scalar, vector, matrix, or *N-D*-array. The size of the returned maximum value depends on the size of the input, and the settings for the **Find the maximum value over** parameter.

This port is unnamed if **Mode** is set to `Running`.

Compute Maximum Value of Input Array

The **Mode** parameter is set to `Value` and `Index` or `Value`. In this case, you can compute the maximum value along any specified dimension of the input or the entire input. The output maximum value is a:

- Scalar if the input is of any size and **Find the maximum value over** parameter is set to `Entire` input.
- Vector if the input is a matrix and the **Find the maximum value over** parameter is set to any one of `Each row`, `Each column`, and `Specified dimension`. In this case, the **Dimension** value for `Specified dimension` can be either 1 or 2.

- $(N-1)$ -D array if the input is an N -D array and the **Find the maximum value over** parameter is set to `Specified dimension` and the **Dimension** value is N .
- N -D array with one singleton dimension if the input is an N -D array and the **Find the maximum value over** parameter is set to either of `Each row`, `Each column`, and `Specified dimension`.

Example: For a 3-D input array of size M -by- N -by- P , the dimension of the returned output is:

- 1-by- N -by- P if you set the **Find the maximum value over** parameter to `Entire row`.
- M -by-1-by- P if you set the **Find the maximum value over** parameter to `Entire column`.
- M -by- N if you set the **Find the maximum value over** parameter to `Specified dimension` and the **Dimension** value to 3.

Compute Maximum Value of Sequence of Inputs

When you set the **Mode** parameter to `Running`, the block computes the maximum value relative to each sample in the input sequence. The output is of the same size as the input.

Data Types: `single` | `double` | `int8` | `int16` | `int32` | `uint8` | `uint16` | `uint32` | `fixed point`

Idx — Indices of maximum values in the input array

`scalar` | `vector` | `matrix` | N -D-array

Indices of maximum values in the input array, returned as a scalar, vector, matrix, or N -D-array. The size of the returned indices depends on the size of the input, and the settings for the **Find the maximum value over** parameter.

To enable this port set the **Mode** parameter to `Value` and `Index` or `Index`. The indices returned at the output is a:

- Scalar if the input is a N -element vector and **Find the maximum value over** parameter is set to `Entire input`.
- Vector if the input is a matrix and the **Find the maximum value over** parameter is set to any one of `Entire input`, `Each row`, `Each column`, and `Specified dimension`. In this case, the **Dimension** value for `Specified dimension` can be either 1 or 2.
- $(N-1)$ -D array if the input is a N -D array and the **Find the maximum value over** parameter is set to `Specified dimension` and the **Dimension** value is N .
- N -D array with one singleton dimension if the input is an N -D array. In this case the **Find the maximum value over** parameter is set to `Each row`, `Each column`, or `Specified dimension`. In this case, the **Dimension** value for `Specified dimension` is an integer less than N .

Example: For a 3-D input array of size M -by- N -by- P , the dimension of the returned output is:

- 1-by- N -by- P if you set the **Find the maximum value over** parameter to `Entire row`.
- M -by-1-by- P if you set the **Find the maximum value over** parameter to `Entire column`.
- M -by- N if you set the **Find the maximum value over** parameter to `Specified dimension` and the **Dimension** value to 3.

Note When a maximum value occurs more than once, the computed index corresponds to the first occurrence. For example, in the input vector `[3 2 1 2 3]`, the maximum value is 3 and the one-based index of the maximum value is 1.

Data Types: single | double | int8 | int16 | int32 | int64 | uint8 | uint16 | uint32 | uint64 | Boolean | fixed point | enumerated | bus

Flag — Validation for ROI

0 | 1

Validation for ROI, returned as 0 or 1. The output value signifies if all of the ROIs specified at the input lie within the image bounds. The output value depends on the values of the **Output** and **ROI Type** parameters.

ROI Type	Output	Output Flag port	Description
<ul style="list-style-type: none"> • Rectangles • Lines 	Individual statistics for each ROI	0	ROI is completely outside the input image.
		1	ROI is either completely or partially inside the input image.
	Single statistic for all ROIs	0	ROI is completely outside the input image.
		1	ROI is either completely or partially inside the input image.
Label matrix	Individual statistics for each ROI	0	Label number is not in the label matrix.
		1	Label number is in the label matrix.
	Single statistic for all ROIs	0	None of the label numbers are in the label matrix.
		1	At least one of the label numbers is in the label matrix.

Note If the ROI is partially outside the image, the block computes the variance values only for the portion of the ROI that lies within the image bounds.

Dependencies

To enable this port, select the **Output flag indicating if ROI is within image bounds** parameter and set the value of **ROI type** parameter to Rectangle, Lines, or Label Matrix.

Parameters

Main Tab

Mode — Output mode

Value and Index (default) | Value | Index | Running

Specify the type of output to be returned by the block. Select the output mode as:

- `Value` and `Index` to return the maximum values and the corresponding indices in the given input.
- `Value` to return only the computed maximum values.
- `Index` to return only the indices of the maximum values in the given input.
- `Running` to return the maximum values in a sequence of inputs.

Index Base — Index origin

One (default) | Zero

Specify the index for the first element in the input array. Select the index origin as:

- `One` for one-based numbering. The range of the index values for the elements in an N-D input array is set to (1, N). For example, the index value for the first element in the matrix is set to (1,1).
- `Zero` for zero-based numbering. The range of the index value for the elements in an N-D input array is set to (0, N-1). For example, the index value for the first element in the matrix is set to (0,0).

Find the maximum value over — Dimension along which maximum is computed

Entire input (default) | Each row | Each column | Specified dimension

Specify the dimension of the input along which the block computes the maximum.

- `Entire input` — Computes maximum over the entire input.
- `Each row` — Computes maximum over each row.
- `Each column` — Computes maximum over each column.
- `Specified dimension`— Computes maximum over the dimension specified in the **Dimension** parameter.
 - If **Dimension** is 1, the output is the same as when you select `Each column`.
 - If **Dimension** is 2, the output is the same as when you select `Each row`.

Dependencies

To enable this parameter, set the **Mode** parameter to `Value and Index`, `Value`, or `Index`.

Dimension — Custom dimension

1 (default) | scalar

Specify the dimension of the input array over which the maximum is computed as a one-based value. The value of this parameter must be greater than 0 and less than or equal to the number of dimensions in the input array.

Dependencies

To enable this parameter, set the **Find the maximum value over** parameter to `Specified dimension`.

Reset port — Reset event

None (default) | Rising edge | Falling edge | Either edge | Non-zero sample

Specify when the block detects a reset event. The block resets the running mode when a reset event is detected at the optional **Rst** port. The reset sample time must be a positive integer and a multiple of the input sample time.

Specify the reset event as:

- None to disable the **Rst** port.
- Rising edge to trigger a reset event when the **Rst** input does one of the following:
 - Rises from a negative value to either a positive value or zero
 - Rises from zero to a positive value, where the rise is not a continuation of a rise from a negative value to zero

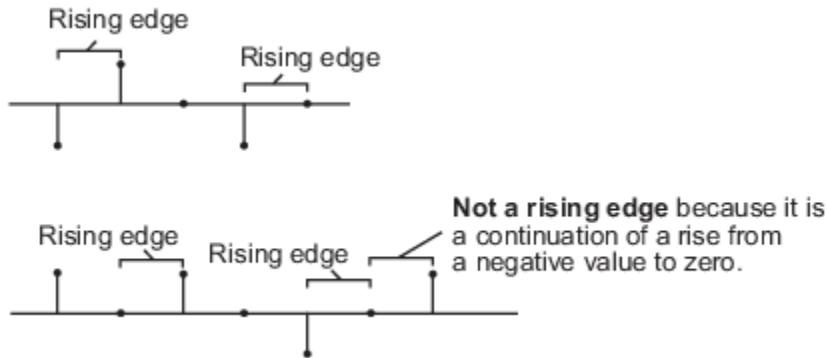

- Falling edge to trigger a reset event when the **Rst** input does one of the following:
 - Falls from a positive value to either a negative value or zero
 - Falls from zero to a negative value, where the fall is not a continuation of a fall from a positive value to zero

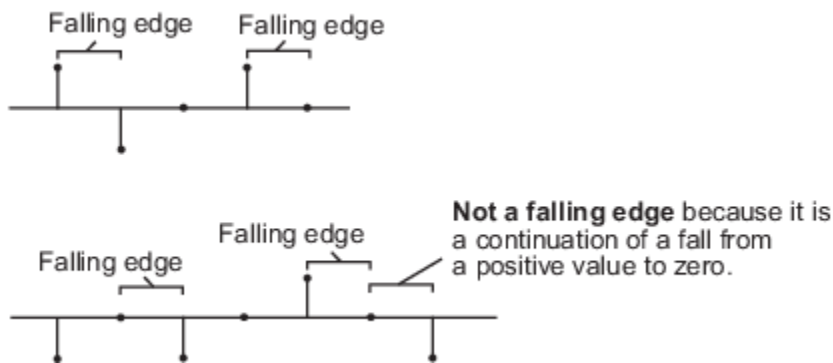

- Either edge to trigger a reset event when the **Rst** input is a Rising edge or Falling edge.
- Non-zero sample to trigger a reset event at each sample time, when the **Rst** input is not zero.

Note When running simulations in the Simulink multitasking mode, reset signals have a one-sample latency. Therefore, when the block detects a reset event, there is a one-sample delay at the reset port rate before the block applies the reset.

Dependencies

To enable this parameter, set the **Mode** parameter to Running.

ROI Processing

Enable ROI processing — Compute maximum value within a particular region

off (default) | on

Select to calculate maximum within a particular ROI in the image.

Note Full ROI processing is available only if you have a Computer Vision Toolbox license. If you do not have a Computer Vision Toolbox license, you can still use ROI processing, but the **ROI type** is limited to Rectangles.

Dependencies

To enable this parameter, set the **Find the maximum value over** parameter to Entire input.

ROI type — Type of ROI

Rectangles (default) | Lines | Label matrix | Binary mask

Specify the type of ROI that represents the regions in the image over which the block computes the variance. The type of ROI can be a rectangle, line, label matrix, or a binary mask.

Parameters		Description
ROI type	Inputs to the ROI port	
Rectangles	<ul style="list-style-type: none"> Four-element row vector [x y width height] m-by-4 matrix $\begin{bmatrix} x_1 & y_1 & width_1 & height_1 \\ x_2 & y_2 & width_2 & height_2 \\ \vdots & \vdots & \vdots & \vdots \\ x_M & y_M & width_M & height_M \end{bmatrix}$ <p>where m is the number of rectangles. Each row of the matrix corresponds to a different rectangle.</p>	<ul style="list-style-type: none"> x and y are the one-based coordinates of the upper left corner of the rectangle. $width$ and $height$ are the width and height, in pixels, of the rectangle. The values of $width$ and $height$ must be greater than 0.

<p>Lines</p>	<ul style="list-style-type: none"> • Four-element row vector $[x_1 \ y_1 \ x_2 \ y_2]$ • m-by-4 matrix $\begin{bmatrix} x_{11} & y_{11} & x_{12} & y_{12} \\ x_{21} & y_{21} & x_{22} & y_{22} \\ \vdots & \vdots & \vdots & \vdots \\ x_{M1} & y_{M1} & x_{M2} & y_{M2} \end{bmatrix}$ <p>where m is the number of lines. Each row of the matrix corresponds to a different line.</p>	<ul style="list-style-type: none"> • x_1 and y_1 are the coordinates of the beginning of the line. • x_2 and y_2 are the coordinates of the end of the line.
<p>Label matrix</p>	<p>M-by-N matrix</p>	<p>Matrix of the same size as the input image. The matrix contains label values that represent different objects in an image. The pixels labeled 0 are the background. The pixels labeled 1 make up one object; the pixels labeled 2 make up a second object; and so on.</p>
<p>Binary mask</p>	<p>M-by-N matrix</p>	<p>Matrix of the same size as the input image. The binary mask classifies image pixels as belonging to either the region of interest or the background. The mask pixel values of 1 indicate that the image pixel belongs to the ROI. The mask pixel values of 0 indicate that the image pixel is part of the background.</p>

Dependencies

To enable this parameter, set the **Find the maximum value over** parameter to Entire input and select the **Enable ROI processing** parameter.

ROI portion to process – Portion of ROI in which to calculate maximum

Entire ROI (default) | ROI perimeter

Specify the portion of the ROI from which the block has to calculate 2-D maximum. The ROI portion is either the entire ROI or the ROI perimeter.

Dependencies

To enable this parameter, select the **Enable ROI processing** parameter and set the **ROI type** parameter to Rectangles.

Output — Calculate maximum for individual or entire ROI

Individual statistics for each ROI (default) | Single statistic for all ROIs

Specify whether to calculate 2-D maximum individually for each ROI or for the entire ROI.

- If you select `Individual statistics for each ROI`, the block outputs a vector of maximum values. The size of the output vector is equal to the number of ROIs.
- If you select `Single statistic for all ROIs`, the block outputs a scalar value. The scalar value represents the statistical value for all the specified ROIs.

Dependencies

To enable this parameter, select the **Enable ROI processing** parameter and set the **ROI type** parameter to `Rectangles`, `Lines`, or `Label matrix`.

Output flag indicating if ROI is within image bounds — Enable Flag port

Off (default) | On

Select to expose the **Flag** port. For a description of the **Flag** port output, see “Flag” on page 1-0 .

Dependencies

To enable this parameter, select the **Enable ROI processing** parameter and set the **ROI type** parameter to `Rectangles`, `Lines`, or `Label matrix`.

Data Types Tab

For details on the fixed-point block parameters, see “Specify Fixed-Point Attributes for Blocks”.

Lock data type settings against change by the fixed-point tools — Prevent fixed-point tools from overriding data types

off (default) | on

Select this parameter to prevent the fixed-point tools from overriding the data types you specify in this block. For more information, see “Lock the Output Data Type Setting” (Fixed-Point Designer).

Block Characteristics

Data Types	double fixed point integer single
Multidimensional Signals	no
Variable-Size Signals	yes

More About**Maximum value of complex inputs**

For complex inputs, the block computes the squared magnitude value for the elements in the input array. The squared magnitude value for a complex number $u = a + bi$ is computed as $a^2 + b^2$. The array element with maximum squared magnitude is the maximum value of the input array.

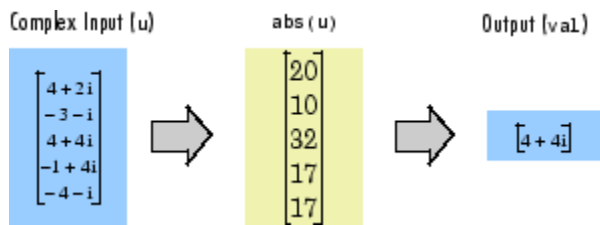

Extended Capabilities

C/C++ Code Generation

Generate C and C++ code using Simulink® Coder™.

See Also

Blocks

2-D Mean | 2-D Minimum | 2-D Variance

Introduced in R2011a

2-D Minimum

Find minimum values in input or sequence of inputs

Library: Computer Vision Toolbox / Statistics

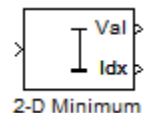

Description

The 2-D Minimum block identifies the value, and optionally the position, of the smallest element in the input. The input can be a vector, a matrix, or an N -D array. The block identifies the minimum value either along a specified dimension of the input or across the entire input. It also tracks the minimum values in a sequence of inputs over a period of time when the **Mode** parameter is set to Running.

Ports

Input

In — Input array

scalar | vector | matrix | N -D array

Input array, specified as a vector, matrix, or N -D array.

Dependencies

The port is named only when you either select **Enable ROI processing** parameter or set the **Mode** parameter to Running.

Data Types: single | double | int8 | int16 | int32 | uint8 | uint16 | uint32 | fixed point
Complex Number Support: Yes

Rst — Reset running minimum

scalar

Reset the running minimum, specified as a scalar. This port specifies the event that causes the block to reset the running minimum. The sample time of the **Rst** input must be a positive integer and a multiple of the block input sample time.

Dependencies

To enable this port, set the **Mode** parameter to Running and set the **Reset port** parameter to Rising edge, Falling edge, Either edge, or Non-zero sample.

Data Types: single | double | int8 | int16 | int32 | uint8 | uint16 | uint32 | Boolean

ROI — Region of interest

four-element vector | m -by-4 matrix | M -by- N matrix

Region of interest (ROI), specified as a four-element vector, m -by-4 matrix, or M -by- N matrix. This port accepts different input values depending on the setting of the **ROI type** parameter.

Note

- You can use the **ROI** port only if the input to the **In** port is a 2-D image.
 - You cannot use the **ROI** port if the **Mode** parameter is set to **Running**.
-

Dependencies

To enable this port, set the **Find the minimum value over** parameter to **Entire input** and select the **Enable ROI processing** parameter.

Data Types: `single` | `double` | `int8` | `int16` | `int32` | `uint8` | `uint16` | `uint32` | `Boolean` | `fixed point`

Label — Label matrix

matrix of nonnegative integers

Label matrix, specified as a matrix of nonnegative integers. The label matrix represents the objects in a 2-D image. The pixels labeled 0 are the background. The pixels labeled 1 make up the first object, the pixels labeled 2 make up the second object, and so on. The size of the label matrix must be same as the size of the 2-D input image.

Dependencies

To enable this port, select the **Enable ROI processing** parameter and set the **ROI type** parameter to **Label matrix**.

Note You cannot enable the **Label** port if the **Mode** parameter is set to **Running**.

Data Types: `uint8` | `uint16` | `uint32`

Label Numbers — Label values of ROIs

M-element vector

Label values of ROI, specified as an *M*-element vector. This represents the object names for the corresponding numbers in the label matrix. *M* must be less than or equal to the number of objects in the label matrix.

Dependencies

To enable this port, select the **Enable ROI processing** parameter and set the **ROI type** parameter to **Label matrix**.

Note You cannot enable the **Label Numbers** port if the **Mode** parameter is set to **Running**.

Data Types: `uint8` | `uint16` | `uint32`

Output**Val — Minimum values of input**

scalar | vector | matrix | *N*-D array

Minimum values of the input, returned as a scalar, vector, matrix, or N -D array. The size of this output depends on the size of the input, and the settings of the **Mode** and **Find the minimum value over** parameters.

Note This port is unnamed if the **Mode** parameter is set to **Running**. It doesn't appear if the **Mode** parameter is set to **Index**.

Compute Minimum Value of Input Array

Set the **Mode** parameter to **Value** and **Index** or **Value**. The block computes the minimum value along the specified dimension of the input or across the entire input. The size of the output minimum value depends on the size of the input and the setting of the **Find the Minimum value over** parameter.

- **Scalar** — The input is of any size, and the **Find the minimum value over** parameter is set to **Entire input**.
- **Vector** — The input is a matrix, and the **Find the minimum value over** parameter is set to **Each row**, **Each column**, or **Specified dimension**. If **Specified dimension** is selected, the value of the **Dimension** parameter must be either 1 or 2.
- **($N-1$)-D array** — The input is an N -D array, the **Find the minimum value over** parameter is set to **Specified dimension**, and the value of the **Dimension** parameter is N .
- **N -D array with one singleton dimension** — The input is an N -D array, and the **Find the minimum value over** parameter is set to **Each row**, **Each column**, or **Specified dimension**. If **Specified dimension** is selected, the value of the **Dimension** parameter must be an integer less than N .

Example: For a 3-D input array of size M -by- N -by- P , the dimension of the returned output is:

- 1-by- N -by- P if you set the **Find the minimum value over** parameter to **Entire row**.
- M -by-1-by- P if you set the **Find the minimum value over** parameter to **Entire column**.
- M -by- N if you set the **Find the minimum value over** parameter to **Specified dimension** and the **Dimension** parameter to 3.

Compute Minimum Value of Sequence of Inputs

Set the **Mode** parameter to **Running**. The block finds the minimum value of all the inputs in the given sequence and compiles them into a single array. The output is of the same size as the input.

Data Types: `single` | `double` | `int8` | `int16` | `int32` | `uint8` | `uint16` | `uint32` | `fixed point`

Idx — Indices of minimum values in the input

`scalar` | `vector` | `matrix` | N -D array

Indices of the minimum values in the input array, returned as a scalar, vector, matrix, or N -D array.

To enable this port, set the **Mode** parameter to **Value** and **Index** or **Index**. The size of the output depends on the size of the input and the setting of the **Find the minimum value over** parameter.

- **Scalar** — The input is an N -element vector, and the **Find the minimum value over** parameter is set to **Entire input**.

- Vector — The input is a matrix, and the **Find the minimum value over** parameter is set to Entire input, Each row, Each column, or Specified dimension. If Specified dimension is selected, the value of the **Dimension** parameter must be either 1 or 2.
- ($N-1$)-D array — The input is an N -D array, the **Find the minimum value over** parameter is set to Specified dimension, and the value of the **Dimension** parameter is N .
- N -D array with one singleton dimension — The input is an N -D array, and the **Find the minimum value over** parameter is set to Each row, Each column, or Specified dimension. If Specified dimension is selected, the value of the **Dimension** parameter must be an integer less than N .

Example: For a 3-D input array of size M -by- N -by- P , the dimension of the returned output is:

- 1-by- N -by- P if you set the **Find the minimum value over** parameter to Entire row.
- M -by-1-by- P if you set the **Find the minimum value over** parameter to Entire column.
- M -by- N if you set the **Find the minimum value over** parameter to Specified dimension and the **Dimension** parameter to 3.

Note When a minimum value occurs more than once, the computed index corresponds to the first occurrence. For example, if the input vector is [3 2 1 2 1], then the minimum value is 1 and the one-based index of the minimum value is 3.

Data Types: single | double | int8 | int16 | int32 | int64 | uint8 | uint16 | uint32 | uint64 | fixed point

Flag — ROI Validation

scalar | vector

ROI Validation, returned as a scalar or vector of logical 1s (true) or 0s (false). If the **ROI type** parameter is set to Rectangles or Lines, the output signifies whether or not the specified ROIs lie completely or partially within the input image. If the **ROI type** parameter is set to Label matrix, the output signifies whether or not the label numbers specified in the **Label Numbers** input are present in the input label matrix.

ROI type	Individual statistics for each ROI	Single statistics for all ROIs
Rectangles	The port returns an m element vector, where m is the number of rows in the $m-4$ matrix in the input to the ROI port. Each element of this vector is a 1 or 0, indicating that the rectangular ROI is either completely or partially inside the input image (1) or completely outside the input image (0).	The port returns a scalar. The scalar is a 1 or 0, indicating that any of the rectangles in the ROI input is present completely or partially inside (1) or completely outside (0) the input image.

Lines	The port returns a scalar. The scalar is a 1 or 0, indicating that the input given to the ROI port is either completely or partially inside (1) the input image or completely outside (0) the input image.	The port returns a scalar. The scalar is a 1 or 0, indicating that the input given to the ROI port is either completely or partially inside (1) the input image or completely outside (0) the input image.
Label matrix	The port returns an M -element vector, where M is the number of elements in the input to the Label Numbers port. Each element of the vector is a 1 or 0, indicating that the associated label from the Label Numbers input is present in (1) or absent from (0) the Label Matrix input.	The port returns a scalar. The scalar is a 1 or 0, indicating that any of the labels in the Label Numbers input are present in (1) or all are absent from (0) the Label Matrix input.

Note If the ROI is partially outside the image, the block computes the statistical values for only the portion of the ROI that lies within the image bounds.

Dependencies

To enable this port, select the **Output flag indicating if ROI is within image bounds** parameter and set the value of the **ROI type** parameter to **Rectangle**, or **Lines**, or select the **Output flag indicating if input label numbers are valid** parameter and set the value of **ROI type** parameter to **Label matrix**.

Parameters

Main

Mode — Output mode

Value and Index (default) | Value | Index | Running

Specify the output mode of the block as one of these options.

- **Value and Index** — Return both the minimum values and their corresponding indices in the given input.
- **Value** — Return only the minimum values.
- **Index** — Return only the indices of the minimum values in the given input.
- **Running** — Tracks the minimum values in a sequence of inputs.

Index Base — Index for first element

One (default) | Zero

Specify the index for the first element in the input array.

- **One** for one-based numbering. The range of index values for each dimension is 1 to m , where m is the length of that dimension. For example, the index of the first element in a matrix is (1, 1).

- Zero for zero-based numbering. The range of index values for each dimension is 0 to $m-1$, where m is the length of that dimension. For example, the index of the first element in a matrix is (0, 0).

Find the minimum value over — Dimension along which minimum is computed

Entire input (default) | Each row | Each column | Specified dimension

Specify the dimension of the input along which the block computes the minimum.

- Entire input — Computes minimum over the entire input.
- Each row — Computes minimum over each row.
- Each column — Computes minimum over each column.
- Specified dimension— Computes minimum over the dimension specified in the **Dimension** parameter.
 - If the **Dimension** parameter is set to 1, the output is the same as when Each column is selected.
 - If the **Dimension** parameter is set to 2, the output is the same as when Each row is selected.

Dependencies

To enable this parameter, set the **Mode** parameter to Value and Index, Value, or Index.

Dimension — Custom dimension

1 (default) | positive scalar

Specify the dimension of the input array over which the block computes the minimum as a one-based value. The value of this parameter must be greater than zero and less than or equal to the number of dimensions in the input array.

Dependencies

To enable this parameter, set the **Find the minimum value over** parameter to Specified dimension.

Reset port — Reset event

None (default) | Rising edge | Falling edge | Either edge | Non-zero sample

Specifies what the block detects as a reset event. The block resets the running minimum when a reset event is detected at the **Rst** port. The reset sample time must be a positive integer and a multiple of the input sample time.

Specify the reset event as one of these options.

- None — Disable the **Rst** port.
- Rising edge — Trigger a reset event when the **Rst** input does one of the following.
 - Rises from a negative value to either a positive value or zero
 - Rises from zero to a positive value, where the rise is not a continuation of a rise from a negative value to zero

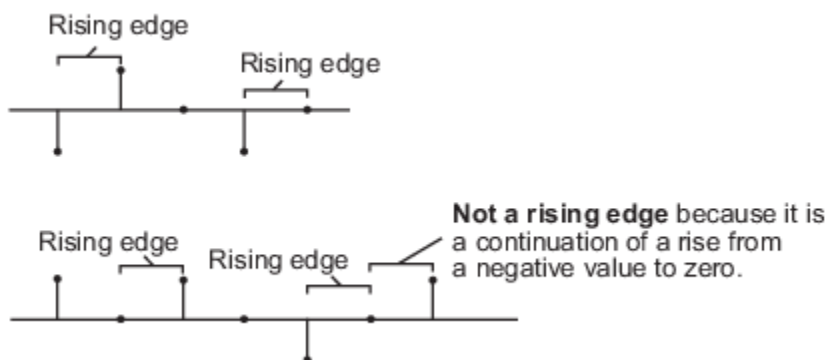

- **Falling edge** — Trigger a reset event when the **Rst** input does one of the following.
 - Falls from a positive value to either a negative value or zero
 - Falls from zero to a negative value, where the fall is not a continuation of a fall from a positive value to zero

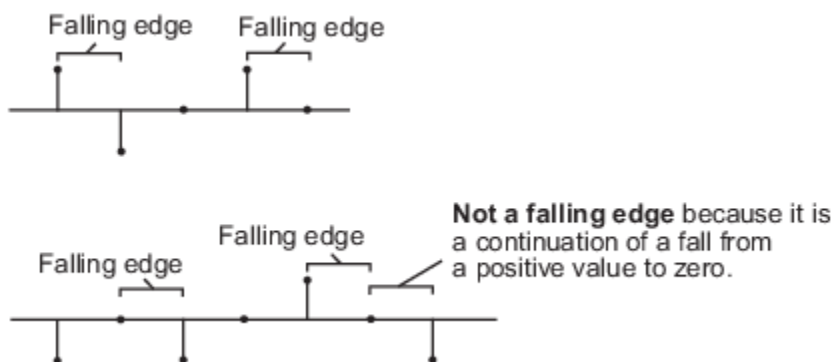

- **Either edge** — Trigger a reset event when the **Rst** input is either a **Rising edge** or a **Falling edge**.
- **Non-zero sample** — Trigger a reset event at each sample time, where the **Rst** input is not zero.

Note When running simulations in Simulink multitasking mode, reset signals have a one-sample latency. In this case, when the block detects a reset event, there is a one-sample delay at the **Rst** port rate before the block applies the reset.

Dependencies

To enable this parameter, set the **Mode** parameter to **Running**.

Enable ROI processing — Compute minimum value within ROI

off (default) | on

Select to calculate the minimum within an ROI in the image.

Note Full ROI processing is available only if you have a Computer Vision Toolbox license. If you do not have a Computer Vision Toolbox license, you can still use ROI processing, but the **ROI type** parameter is limited to **Rectangles**.

Dependencies

To enable this parameter, set the **Find the minimum value over** parameter to Entire input.

ROI type – Format of ROI

Rectangles (default) | Lines | Label matrix | Binary mask

Specify the ROI format that represents the regions in the image over which to compute the minimum. The type of ROI can be a rectangle, line, label matrix, or a binary mask.

ROI type	Inputs to the ROI port	Description
Rectangles	<ul style="list-style-type: none"> Four-element row vector $[x\ y\ width\ height]$ m-by-4 matrix : $\begin{bmatrix} x_1 & y_1 & width_1 & height_1 \\ x_2 & y_2 & width_2 & height_2 \\ \vdots & \vdots & \vdots & \vdots \\ x_M & y_M & width_M & height_M \end{bmatrix}$ <p>where m is the number of rectangle ROIs. Each row of the matrix corresponds to a different rectangle.</p>	<ul style="list-style-type: none"> x and y are the one-based coordinates of the upper left corner of the rectangle. $width$ and $height$ are the width and height, in pixels, of the rectangle. The values of $width$ and $height$ must be greater than zero.
Lines	<ul style="list-style-type: none"> Four-element row vector $[x_1\ y_1\ x_2\ y_2]$ m-by-4 matrix $\begin{bmatrix} x_{11} & y_{11} & x_{12} & y_{12} \\ x_{21} & y_{21} & x_{22} & y_{22} \\ \vdots & \vdots & \vdots & \vdots \\ x_{M1} & y_{M1} & x_{M2} & y_{M2} \end{bmatrix}$ <p>where m is the number of lines. Each row of the matrix corresponds to a different line.</p>	<ul style="list-style-type: none"> x_1 and y_1 are the coordinates of the beginning of the line. x_2 and y_2 are the coordinates of the end of the line.
Label matrix	M -by- N matrix	Matrix of the same size as the input image. The matrix contains label values that represent different objects in an image. The pixels labeled 0 are the background. The pixels labeled 1 make up one object, the pixels labeled 2 make up a second object, and so on.

Binary mask	M -by- N matrix	Matrix of the same size as the input image. The binary mask classifies image pixels as belonging to either the region of interest or the background. Binary mask values of 1 indicate that the corresponding image pixel belongs to the ROI. Binary mask values of 0 indicate that the corresponding image pixel is part of the background.
-------------	---------------------	---

Dependencies

To enable this parameter, set the **Find the minimum value over** parameter to Entire input and select the **Enable ROI processing** parameter.

ROI portion to process — Portion of ROI in which to calculate minimum

Entire ROI (default) | ROI perimeter

Specify the portion of the ROI for which the block calculates the 2-D minimum.

- Entire ROI — The block computes the minimum value over the entire region of the rectangular ROI.
- ROI perimeter — The block computes the minimum value along the perimeter of the rectangular ROI.

Dependencies

To enable this parameter, select the **Enable ROI processing** parameter and set the **ROI type** parameter to Rectangles.

Output — Calculate individual or universal minimum for ROIs

Individual statistics for each ROI (default) | Single statistic for all ROIs

Specify whether to calculate the 2-D minimum individually for each ROI or across all ROIs.

- If you select Individual statistics for each ROI, the block outputs a vector of minimum values, each element representing an ROI. The size of the output vector is equal to the number of ROIs.
- If you select Single statistic for all ROIs, the block outputs a scalar value. The scalar value is the minimum value across all specified ROIs.

Dependencies

To enable this parameter, select the **Enable ROI processing** parameter and set the **ROI type** parameter to Rectangles, Lines, or Label matrix.

Output flag indicating if ROI is within image bounds — Enable Flag port

off (default) | on

Select to enable the Flag output port.

Note The name of this parameter changes to **Output flag indicating if input label numbers are valid** when the **ROI type** parameter is set to `Label matrix`.

Dependencies

To enable this parameter, select the **Enable ROI processing** parameter and set the **ROI type** parameter to `Rectangles`, or `Lines`.

Data Types

For details on the fixed-point block parameters, see “Specify Fixed-Point Attributes for Blocks”.

Lock data type settings against change by the fixed-point tools – Prevent fixed-point tools from overriding data types

off (default) | on

Select this parameter to prevent the fixed-point tools from overriding the data types you specify in this block. For more information, see “Lock the Output Data Type Setting” (Fixed-Point Designer).

Block Characteristics

Data Types	double fixed point integer single
Multidimensional Signals	no
Variable-Size Signals	yes

Extended Capabilities

C/C++ Code Generation

Generate C and C++ code using Simulink® Coder™.

See Also

Blocks

2-D Mean | 2-D Variance | 2-D Maximum

Introduced before R2006a

2-D Standard Deviation

Compute standard deviation of input or sequence of inputs

Library: Computer Vision Toolbox / Statistics

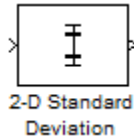

Description

The 2-D Standard Deviation block computes the standard deviation of an input array. The input can be a 1-D vector, 2-D matrix, or an N -D-array. The block can compute standard deviation along a specified dimension of the input or the entire input. If you select the **Running standard deviation** parameter, the block can also track the standard deviation in a sequence of inputs over a time period.

Ports

Input

In — Input array

vector | matrix | N -D- array

Input array, specified as a vector, matrix, or N -D- array. This port is unnamed until you select the **Enable ROI processing** parameter.

Data Types: single | double

Rst — Reset port

scalar

Reset port, specified as a scalar. This port specifies the event that causes the block to reset the running standard deviation. The sample time of the **Rst** input must be a positive integer and a multiple of the input sample time.

Dependencies

To enable this port, select the **Running standard deviation** parameter and set the **Reset port** parameter to Rising edge, Falling edge, Either edge, or Non-zero sample.

Data Types: single | double | int8 | int16 | int32 | uint8 | uint16 | uint32 | Boolean

ROI — Region of interest

four-element vector | m -by-4 matrix | M -by- N matrix

Region of interest (ROI), specified as a four-element vector, m -by-4 matrix, or M -by- N matrix. The input value to this port depends on the **ROI type** parameter.

Note You can use the ROI port only if the input is a 2-D image.

Dependencies

To enable this port, set the **Find the standard deviation value over** parameter to `Entire input` and select the **Enable ROI processing** parameter.

Data Types: `single` | `double` | `int8` | `int16` | `int32` | `uint8` | `uint16` | `uint32` | `Boolean` | `fixed point`

Label – Label matrix

matrix of nonnegative integers

Label matrix, specified as a matrix of nonnegative integers. The label matrix represents the objects in an image. The pixels labeled 0 are the background. The pixels labeled 1 make up one object; the pixels labeled 2 make up a second object; and so on. The size of the label matrix must be the same size as the 2-D input.

Dependencies

To enable this port, select the **Enable ROI processing** parameter and set the **ROI type** parameter to `Label matrix`.

Data Types: `uint8` | `uint16` | `uint32`

Label Numbers – Label values of ROIs

M -element vector

Label values of ROIs, specified as a M -element vector. The value of M can be less than or equal to the number of objects that are labeled in the label matrix.

Dependencies

To enable this port, select the **Enable ROI processing** parameter and set the **ROI type** parameter to `Label matrix`.

Data Types: `uint8` | `uint16` | `uint32`

Output**Out – Computed output standard deviation**

`scalar` | `vector` | `matrix` | N -D-array

Computed output standard deviation, returned as a scalar, vector, matrix, or N -D-array. The size of the returned output standard deviation depends on the size of the input, and the settings for the **Running standard deviation** and **Find the standard deviation value over** parameters.

This port is unnamed until you select the **Output flag indicating if ROI is within image bounds** and the **ROI type** parameter is set to `Rectangles`, `Lines`, or `Label matrix`.

If Running standard deviation Is Cleared

You can compute standard deviation along any specified dimension of the input or the entire input. The output is a:

- Scalar if the input is of any size and the **Find the standard deviation value over** parameter is set to `Entire input`.
- Vector if the input is a matrix and the **Find the standard deviation value over** parameter is set to any one of `Each row`, `Each column`, and `Specified dimension`. In this case, the **Dimension** value for `Specified dimension` can be either 1 or 2.

- Matrix if the input is a 3-D array and the **Find the standard deviation value over** parameter is set to `Specified dimension` and the **Dimension** value is 3.
- N -D array if the input is an N -D array and the **Find the standard deviation value over** parameter is set to an option other than `Entire input`.

If you compute standard deviation along the N th dimension of the input, then the returned output is an $(N-1)$ -D array. In this case, the **Dimension** value for `Specified dimension` is set to N .

Example: For a 3-D input array of size M -by- N -by- P , the dimension of the returned output is:

- 1-by- N -by- P if you set the **Find the standard deviation value over** parameter to `Entire row`.
- M -by-1-by- P if you set the **Find the standard deviation value over** parameter to `Entire column`.
- M -by- N if you set the **Find the standard deviation value over** parameter to `Specified dimension` and the **Dimension** value to 3.

If Running standard deviation Is Selected

When you select the **Running standard deviation** parameter, the block computes the standard deviation of each sample in the input with respect to all previous samples. The output is of the same size as the input.

Data Types: `single` | `double` | `int8` | `int16` | `int32` | `uint8` | `uint16` | `uint32` | `fixed point`

Flag — Validation for ROI

0 | 1

Validation for ROI, returned as 0 or 1. The output value signifies if all of the ROIs specified at the input lie within the image bounds. The output value depends on the values of the **Output** and **ROI Type** parameters.

ROI Type	Output	Output Flag port	Description
<ul style="list-style-type: none"> • Rectangles • Lines 	Individual statistics for each ROI	0	ROI is completely outside the input image.
		1	ROI is either completely or partially inside the input image.
	Single statistic for all ROIs	0	ROI is completely outside the input image.
		1	ROI is either completely or partially inside the input image.
Label matrix	Individual statistics for each ROI	0	Label number is not in the label matrix.
		1	Label number is in the label matrix.
	Single statistic for all ROIs	0	None of the label numbers are in the label matrix.

		1	At least one of the label numbers is in the label matrix.
--	--	---	---

Note If the ROI is partially outside the image, the block computes the standard deviation values only for the portion of the ROI that lies within the image bounds.

Dependencies

To enable this port, select the **Output flag indicating if ROI is within image bounds** parameter and set the value of **ROI type** parameter to Rectangle, Lines, or Label Matrix.

Parameters

Main Tab

Running standard deviation – Track running standard deviation

off (default) | on

Select to track the standard deviation of successive inputs to the block. In this mode, the block treats each element as a channel.

Reset port – Reset event

None (default) | Rising edge | Falling edge | Either edge | Non-zero sample

Specify when the block detects a reset event. The block resets the running standard deviation when a reset event is detected at the optional **Rst** port. The reset sample time must be a positive integer and a multiple of the input sample time.

Specify the reset event as:

- None to disable the **Rst** port.
- Rising edge to trigger a reset event when the **Rst** input does one of the following:
 - Rises from a negative value to either a positive value or zero
 - Rises from zero to a positive value, where the rise is not a continuation of a rise from a negative value to zero

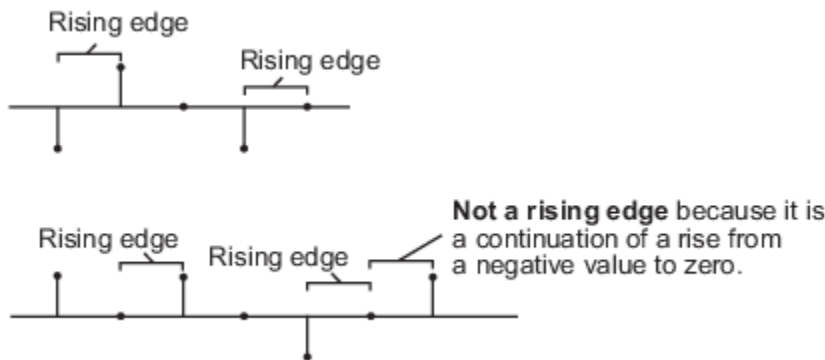

- Falling edge to trigger a reset event when the **Rst** input does one of the following:

- Falls from a positive value to either a negative value or zero
- Falls from zero to a negative value, where the fall is not a continuation of a fall from a positive value to zero

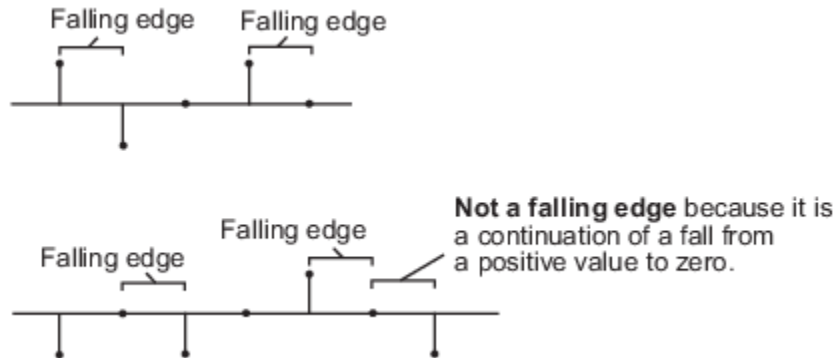

- Either edge to trigger a reset event when the **Rst** input is a Rising edge or Falling edge.
- Non-zero sample to trigger a reset event at each sample time, when the **Rst** input is not zero.

Note When running simulations in the Simulink multitasking mode, reset signals have a one-sample latency. Therefore, when the block detects a reset event, there is a one-sample delay at the reset port rate before the block applies the reset.

Dependencies

To enable this parameter, select the **Running standard deviation** parameter.

Find the standard deviation value over — Dimension along which standard deviation is computed

Entire input (default) | Each row | Each column | Specified dimension

Specify the dimension of the input along which the block computes the standard deviation.

- Entire input — Computes standard deviation over the entire input.
- Each row — Computes standard deviation over each row.
- Each column — Computes standard deviation over each column.
- Specified dimension— Computes standard deviation over the dimension specified in the **Dimension** parameter. By default, the **Dimension** parameter is set to 1 and the output is the same as when you select Each column.

Dependencies

To enable this parameter, clear the **Running standard deviation** parameter.

Dimension — Custom dimension

1 (default)

Specify the dimension of the input array over which the standard deviation is computed as a one-based value. The value of this parameter is set to 1..

Dependencies

To enable this parameter, set the **Find the standard deviation value over** parameter to Specified dimension.

ROI Processing

Enable ROI processing – Compute standard deviation within a particular region

off (default) | on

Select to calculate standard deviation within a particular ROI in the image.

Note Full ROI processing is available only if you have a Computer Vision Toolbox license. If you do not have a Computer Vision Toolbox license, you can still use ROI processing, but the **ROI type** is limited to Rectangles.

Dependencies

To enable this parameter, set the **Find the standard deviation value over** parameter to Entire input.

ROI type – Type of ROI

Rectangles (default) | Lines | Label matrix | Binary mask

Specify the type of ROI that represents the regions in the image over which the block computes the standard deviation. The type of ROI can be a rectangle, line, label matrix, or a binary mask.

Parameters		Description
ROI type	Inputs to the ROI port	
Rectangles	<ul style="list-style-type: none"> Four-element row vector [x y width height] <i>m</i>-by-4 matrix $\begin{bmatrix} x_1 & y_1 & width_1 & height_1 \\ x_2 & y_2 & width_2 & height_2 \\ \vdots & \vdots & \vdots & \vdots \\ x_M & y_M & width_M & height_M \end{bmatrix}$ <p>where <i>m</i> is the number of rectangles. Each row of the matrix corresponds to a different rectangle.</p>	<ul style="list-style-type: none"> <i>x</i> and <i>y</i> are the one-based coordinates of the upper left corner of the rectangle. <i>width</i> and <i>height</i> are the width and height, in pixels, of the rectangle. The values of <i>width</i> and <i>height</i> must be greater than 0.

Lines	<ul style="list-style-type: none"> Four-element row vector $[x_1 \ y_1 \ x_2 \ y_2]$ m-by-4 matrix $\begin{bmatrix} x_{11} & y_{11} & x_{12} & y_{12} \\ x_{21} & y_{21} & x_{22} & y_{22} \\ \vdots & \vdots & \vdots & \vdots \\ x_{M1} & y_{M1} & x_{M2} & y_{M2} \end{bmatrix}$ <p>where m is the number of lines. Each row of the matrix corresponds to a different line.</p>	<ul style="list-style-type: none"> x_1 and y_1 are the coordinates of the beginning of the line. x_2 and y_2 are the coordinates of the end of the line.
Label matrix	M -by- N matrix	Matrix of the same size as the input image. The matrix contains label values that represent different objects in an image. The pixels labeled 0 are the background. The pixels labeled 1 make up one object; the pixels labeled 2 make up a second object; and so on.
Binary mask	M -by- N matrix	Matrix of the same size as the input image. The binary mask classifies image pixels as belonging to either the region of interest or the background. The mask pixel values of 1 indicate that the image pixel belongs to the ROI. The mask pixel values of 0 indicate that the image pixel is part of the background.

Dependencies

To enable this parameter, select the **Enable ROI processing** parameter.

ROI portion to process – Portion of ROI in which to calculate standard deviation

Entire ROI (default) | ROI perimeter

Specify the portion of the ROI from which the block has to calculate 2-D standard deviation. The ROI portion is either the entire ROI or the ROI perimeter.

Dependencies

To enable this parameter, select the **Enable ROI processing** parameter and set the **ROI type** parameter to Rectangles.

Output – Calculate standard deviation for individual or entire ROI

Individual statistics for each ROI (default) | Single statistic for all ROIs

Specify whether to calculate 2-D standard deviation individually for each ROI or for the entire ROI.

- If you select `Individual statistics for each ROI`, the block outputs a vector of standard deviation values. The size of the output vector is equal to the number of ROIs.
- If you select `Single statistic for all ROIs`, the block outputs a scalar value. The scalar value represents the statistical value for all the specified ROIs.

Dependencies

To enable this parameter, select the **Enable ROI processing** parameter and set the **ROI type** parameter to `Rectangles`, `Lines`, or `Label matrix`.

Output flag indicating if ROI is within image bounds — Enable Flag port

Off (default) | On

Select to expose the **Flag** port. For a description of the **Flag** port output, see “Flag” on page 1-0 .

Dependencies

To enable this parameter, select the **Enable ROI processing** parameter and set the **ROI type** parameter to `Rectangles`, `Lines`, or `Label matrix`.

Data Types Tab

For details on the fixed-point block parameters, see “Specify Fixed-Point Attributes for Blocks”.

Lock data type settings against change by the fixed-point tools — Prevent fixed-point tools from overriding data types

off (default) | on

Select this parameter to prevent the fixed-point tools from overriding the data types you specify in this block. For more information, see “Lock the Output Data Type Setting” (Fixed-Point Designer).

Block Characteristics

Data Types	double single
Multidimensional Signals	no
Variable-Size Signals	yes

Extended Capabilities

C/C++ Code Generation

Generate C and C++ code using Simulink® Coder™.

See Also

2-D Mean | var | 2-D Variance

Introduced in R2011b

2-D Variance

Compute variance of input or sequence of inputs

Library: Computer Vision Toolbox / Statistics

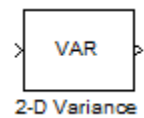

Description

The 2-D Variance block computes the unbiased variance of an input array. The input can be a 1-D vector, 2-D matrix, or an N -D-array. The block can compute variance along a specified dimension of the input or the entire input. If you select the **Running variance** parameter, the block can also track the variance in a sequence of inputs over a time period.

Ports

Input

In — Input array

vector | matrix | N -D- array

Input array, specified as a vector, matrix, or N -D- array. This port is unnamed until you select the **Enable ROI processing** parameter.

Data Types: single | double | int8 | int16 | int32 | uint8 | uint16 | uint32 | fixed point

Rst — Reset port

scalar

Reset port, specified as a scalar. This port specifies the event that causes the block to reset the running variance. The sample time of the **Rst** input must be a positive integer and a multiple of the input sample time.

Dependencies

To enable this port, select the **Running variance** parameter and set the **Reset port** parameter to Rising edge, Falling edge, Either edge, or Non-zero sample.

Data Types: single | double | int8 | int16 | int32 | uint8 | uint16 | uint32 | Boolean

ROI — Region of interest

four-element vector | m -by-4 matrix | M -by- N matrix

Region of interest (ROI), specified as a four-element vector, m -by-4 matrix, or M -by- N matrix. The input value to this port depends on the **ROI type** parameter.

Note You can use the ROI port only if the input is a 2-D image.

Dependencies

To enable this port, set the **Find the variance value over** parameter to `Entire input` and select the **Enable ROI processing** parameter.

Data Types: `single` | `double` | `int8` | `int16` | `int32` | `uint8` | `uint16` | `uint32` | `Boolean` | `fixed point`

Label — Label matrix

matrix of nonnegative integers

Label matrix, specified as a matrix of nonnegative integers. The label matrix represents the objects in an image. The pixels labeled 0 are the background. The pixels labeled 1 make up one object; the pixels labeled 2 make up a second object; and so on. The size of the label matrix must be the same size as the 2-D input.

Dependencies

To enable this port, select the **Enable ROI processing** parameter and set the **ROI type** parameter to `Label matrix`.

Data Types: `uint8` | `uint16` | `uint32`

Label Numbers — Label values of ROIs

M -element vector

Label values of ROIs, specified as a M -element vector. The value of M can be less than or equal to the number of objects that are labeled in the label matrix.

Dependencies

To enable this port, select the **Enable ROI processing** parameter and set the **ROI type** parameter to `Label matrix`.

Data Types: `uint8` | `uint16` | `uint32`

Output

Out — Computed output variance

scalar | vector | matrix | N -D-array

Computed output variance, returned as a scalar, vector, matrix, or N -D-array. The size of the returned output variance depends on the size of the input, and the settings for the **Running variance** and **Find the variance value over** parameters.

This port is unnamed until you select the **Output flag indicating if ROI is within image bounds** and the **ROI type** parameter is set to `Rectangles`, `Lines`, or `Label matrix`.

If Running variance Is Cleared

You can compute variance along any specified dimension of the input or the entire input. The output is a:

- Scalar if the input is of any size and the **Find the variance value over** parameter is set to `Entire input`.
- Vector if the input is a matrix and the **Find the variance value over** parameter is set to any one of `Each row`, `Each column`, and `Specified dimension`. In this case, the **Dimension** value for `Specified dimension` can be either 1 or 2.

- Matrix if the input is a 3-D array and the **Find the variance value over** parameter is set to `Specified dimension` and the **Dimension** value is 3.
- N -D array if the input is an N -D array and the **Find the variance value over** parameter is set to an option other than `Entire input`.

If you compute variance along the N th dimension of the input, then the returned output is an $(N-1)$ -D array. In this case, the **Dimension** value for `Specified dimension` is set to N .

Example: For a 3-D input array of size M -by- N -by- P , the dimension of the returned output is:

- 1-by- N -by- P if you set the **Find the variance value over** parameter to `Entire row`.
- M -by-1-by- P if you set the **Find the variance value over** parameter to `Entire column`.
- M -by- N if you set the **Find the variance value over** parameter to `Specified dimension` and the **Dimension** value to 3.

If Running variance Is Selected

When you select the **Running variance** parameter, the block computes the variance of each sample in the input with respect to all previous samples. The output is of the same size as the input.

Data Types: `single` | `double` | `int8` | `int16` | `int32` | `uint8` | `uint16` | `uint32` | `fixed point`

Flag — Validation for ROI

0 | 1

Validation for ROI, returned as 0 or 1. The output value signifies if all of the ROIs specified at the input lie within the image bounds. The output value depends on the values of the **Output** and **ROI Type** parameters.

ROI Type	Output	Output Flag port	Description
<ul style="list-style-type: none"> • Rectangles • Lines 	Individual statistics for each ROI	0	ROI is completely outside the input image.
		1	ROI is either completely or partially inside the input image.
	Single statistic for all ROIs	0	ROI is completely outside the input image.
		1	ROI is either completely or partially inside the input image.
Label matrix	Individual statistics for each ROI	0	Label number is not in the label matrix.
		1	Label number is in the label matrix.
	Single statistic for all ROIs	0	None of the label numbers are in the label matrix.
		1	At least one of the label numbers is in the label matrix.

Note If the ROI is partially outside the image, the block computes the variance values only for the portion of the ROI that lies within the image bounds.

Dependencies

To enable this port, select the **Output flag indicating if ROI is within image bounds** parameter and set the value of **ROI type** parameter to Rectangle, Lines, or Label Matrix.

Parameters

Main Tab

Running variance — Track running variance

off (default) | on

Select to track the variance of successive inputs to the block. In this mode, the block treats each element as a channel.

Reset port — Reset event

None (default) | Rising edge | Falling edge | Either edge | Non-zero sample

Specify when the block detects a reset event. The block resets the running variance when a reset event is detected at the optional **Rst** port. The reset sample time must be a positive integer and a multiple of the input sample time.

Specify the reset event as:

- None to disable the **Rst** port.
- Rising edge to trigger a reset event when the **Rst** input does one of the following:
 - Rises from a negative value to either a positive value or zero
 - Rises from zero to a positive value, where the rise is not a continuation of a rise from a negative value to zero

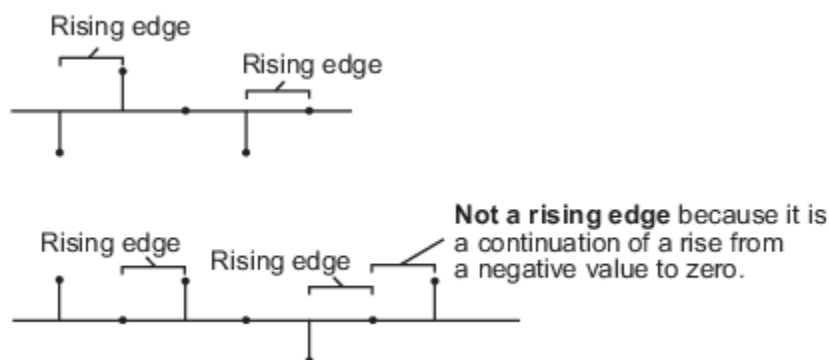

- Falling edge to trigger a reset event when the **Rst** input does one of the following:
 - Falls from a positive value to either a negative value or zero
 - Falls from zero to a negative value, where the fall is not a continuation of a fall from a positive value to zero

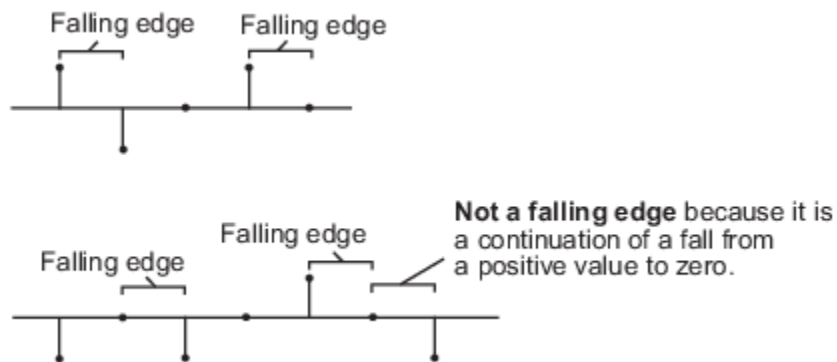

- Either edge to trigger a reset event when the **Rst** input is a Rising edge or Falling edge.
- Non-zero sample to trigger a reset event at each sample time, when the **Rst** input is not zero.

Note When running simulations in the Simulink multitasking mode, reset signals have a one-sample latency. Therefore, when the block detects a reset event, there is a one-sample delay at the reset port rate before the block applies the reset.

Dependencies

To enable this parameter, select the **Running variance** parameter.

Find the variance value over — Dimension along which variance is computed

Entire input (default) | Each row | Each column | Specified dimension

Specify the dimension of the input along which the block computes the variance.

- Entire input — Computes variance over the entire input.
- Each row — Computes variance over each row.
- Each column — Computes variance over each column.
- Specified dimension— Computes variance over the dimension specified in the **Dimension** parameter.
 - If **Dimension** is 1, the output is the same as when you select Each column.
 - If **Dimension** is 2, the output is the same as when you select Each row.

Dependencies

To enable this parameter, clear the **Running variance** parameter.

Dimension — Custom dimension

1 (default) | scalar

Specify the dimension of the input array over which the variance is computed as a one-based value. The value of this parameter must be greater than 0 and less than or equal to the number of dimensions in the input array.

Dependencies

To enable this parameter, set the **Find the variance value over** parameter to Specified dimension.

ROI Processing

Enable ROI processing — Compute variance within a particular region

off (default) | on

Select to calculate variance within a particular ROI in the image.

Note Full ROI processing is available only if you have a Computer Vision Toolbox license. If you do not have a Computer Vision Toolbox license, you can still use ROI processing, but the **ROI type** is limited to Rectangles.

Dependencies

To enable this parameter, set the **Find the variance value over** parameter to Entire input.

ROI type — Type of ROI

Rectangles (default) | Lines | Label matrix | Binary mask

Specify the type of ROI that represents the regions in the image over which the block computes the variance. The type of ROI can be a rectangle, line, label matrix, or a binary mask.

Parameters		Description
ROI type	Inputs to the ROI port	
Rectangles	<ul style="list-style-type: none"> Four-element row vector [x y width height] m-by-4 matrix $\begin{bmatrix} x_1 & y_1 & width_1 & height_1 \\ x_2 & y_2 & width_2 & height_2 \\ \vdots & \vdots & \vdots & \vdots \\ x_M & y_M & width_M & height_M \end{bmatrix}$ <p>where m is the number of rectangles. Each row of the matrix corresponds to a different rectangle.</p>	<ul style="list-style-type: none"> x and y are the one-based coordinates of the upper left corner of the rectangle. $width$ and $height$ are the width and height, in pixels, of the rectangle. The values of $width$ and $height$ must be greater than 0.

Lines	<ul style="list-style-type: none"> Four-element row vector $[x_1 \ y_1 \ x_2 \ y_2]$ m-by-4 matrix $\begin{bmatrix} x_{11} & y_{11} & x_{12} & y_{12} \\ x_{21} & y_{21} & x_{22} & y_{22} \\ \vdots & \vdots & \vdots & \vdots \\ x_{M1} & y_{M1} & x_{M2} & y_{M2} \end{bmatrix}$ <p>where m is the number of lines. Each row of the matrix corresponds to a different line.</p>	<ul style="list-style-type: none"> x_1 and y_1 are the coordinates of the beginning of the line. x_2 and y_2 are the coordinates of the end of the line.
Label matrix	M -by- N matrix	Matrix of the same size as the input image. The matrix contains label values that represent different objects in an image. The pixels labeled 0 are the background. The pixels labeled 1 make up one object; the pixels labeled 2 make up a second object; and so on.
Binary mask	M -by- N matrix	Matrix of the same size as the input image. The binary mask classifies image pixels as belonging to either the region of interest or the background. The mask pixel values of 1 indicate that the image pixel belongs to the ROI. The mask pixel values of 0 indicate that the image pixel is part of the background.

Dependencies

To enable this parameter, select the **Enable ROI processing** parameter.

ROI portion to process – Portion of ROI in which to calculate variance

Entire ROI (default) | ROI perimeter

Specify the portion of the ROI from which the block has to calculate 2-D variance. The ROI portion is either the entire ROI or the ROI perimeter.

Dependencies

To enable this parameter, select the **Enable ROI processing** parameter and set the **ROI type** parameter to Rectangles.

Output – Calculate variance for individual or entire ROI

Individual statistics for each ROI (default) | Single statistic for all ROIs

Specify whether to calculate 2-D variance individually for each ROI or for the entire ROI.

- If you select **Individual statistics for each ROI**, the block outputs a vector of variance values. The size of the output vector is equal to the number of ROIs.
- If you select **Single statistic for all ROIs**, the block outputs a scalar value. The scalar value represents the statistical value for all the specified ROIs.

Dependencies

To enable this parameter, select the **Enable ROI processing** parameter and set the **ROI type** parameter to **Rectangles**, **Lines**, or **Label matrix**.

Output flag indicating if ROI is within image bounds — Enable Flag port

Off (default) | On

Select to expose the **Flag** port. For a description of the **Flag** port output, see “Flag” on page 1-0 .

Dependencies

To enable this parameter, select the **Enable ROI processing** parameter and set the **ROI type** parameter to **Rectangles**, **Lines**, or **Label matrix**.

Data Types Tab

For details on the fixed-point block parameters, see “Specify Fixed-Point Attributes for Blocks”.

Lock data type settings against change by the fixed-point tools — Prevent fixed-point tools from overriding data types

off (default) | on

Select this parameter to prevent the fixed-point tools from overriding the data types you specify in this block. For more information, see “Lock the Output Data Type Setting” (Fixed-Point Designer).

Block Characteristics

Data Types	double fixed point integer single
Multidimensional Signals	yes
Variable-Size Signals	yes

More About

Variance

The variance of an input is the square of the standard deviation of the input. Variance gives a measure of deviation of the input values from its mean value.

For a purely real or imaginary input, u , of size M -by- N , the variance is:

$$y = \sigma^2 = \frac{\sum_{i=1}^M \sum_{j=1}^N |u_{ij}|^2 - \left| \frac{\sum_{i=1}^M \sum_{j=1}^N u_{ij}}{M*N} \right|^2}{M*N - 1},$$

where:

- u_{ij} is the input data element at (i, j) .
- M is the length of the j th column.
- N is the number of columns.

For complex inputs, the variance is:

$$\sigma^2 = \sigma_{Re}^2 + \sigma_{Im}^2,$$

where:

- σ_{Re}^2 is the variance of the real part of the complex input.
- σ_{Im}^2 is the variance of the imaginary part of the complex input.

Extended Capabilities

C/C++ Code Generation

Generate C and C++ code using Simulink® Coder™.

See Also

2-D Mean | 2-D Standard Deviation | var

Introduced before R2006a

Autothreshold

Convert intensity image to binary image

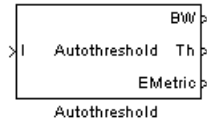

Library

Conversions

visionconversions

Description

The Autothreshold block converts an intensity image to a binary image using a threshold value computed using Otsu's method.

This block computes this threshold value by splitting the histogram of the input image such that the variance of each pixel group is minimized.

Port	Input/Output	Supported Data Types	Complex Values Supported
I	Vector or matrix of intensity values	<ul style="list-style-type: none"> Double-precision floating point Single-precision floating point Fixed point 8-, 16-, and 32-bit signed integer 8-, 16-, and 32-bit unsigned integer 	No
BW	Scalar, vector, or matrix that represents a binary image	Boolean	No
Th	Threshold value	Same as I port	No
EMetric	Effectiveness metric	Same as I port	No

Use the **Thresholding operator** parameter to specify the condition the block places on the input values. If you select $>$ and the input value is greater than the threshold value, the block outputs 1 at the BW port; otherwise, it outputs 0. If you select \leq and the input value is less than or equal to the threshold value, the block outputs 1; otherwise, it outputs 0.

Select the **Output threshold** check box to output the calculated threshold values at the Th port.

Select the **Output effectiveness metric** check box to output values that represent the effectiveness of the thresholding at the EMetric port. This metric ranges from 0 to 1. If every pixel has the same value, the effectiveness metric is 0. If the image has two pixel values or the histogram of the image pixels is symmetric, the effectiveness metric is 1.

If you clear the **Specify data range** check box, the block assumes that floating-point input values range from 0 to 1. To specify a different data range, select this check box. The **Minimum value of input** and **Maximum value of input** parameters appear in the dialog box. Use these parameters to enter the minimum and maximum values of your input signal.

Use the **When data range is exceeded** parameter to specify the block's behavior when the input values are outside the expected range. The following options are available:

- **Ignore** — Proceed with the computation and do not issue a warning message. If you choose this option, the block performs the most efficient computation. However, if the input values exceed the expected range, the block produces incorrect results.
- **Saturate** — Change any input values outside the range to the minimum or maximum value of the range and proceed with the computation.
- **Warn and saturate** — Display a warning message in the MATLAB Command Window, saturate values, and proceed with the computation.
- **Error** — Display an error dialog box and terminate the simulation.

If you clear the **Scale threshold** check box, the block uses the threshold value computed by Otsu's method to convert intensity images into binary images. If you select the **Scale threshold** check box, the **Threshold scaling factor** appears in the dialog box. Enter a scalar value. The block multiplies this scalar value with the threshold value computed by Otsu's method and uses the result as the new threshold value.

Fixed-Point Data Types

The following diagram shows the data types used in the Autothreshold block for fixed-point signals. You can use the default fixed-point parameters if your input has a word length less than or equal to 16.

In this diagram, DT means data type. You can set the product, accumulator, quotient, and effectiveness metric data types in the block mask.

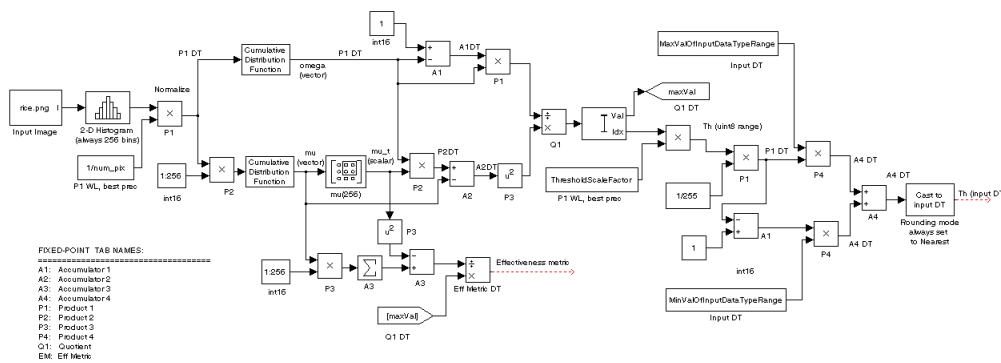

Parameters

Thresholding operator

Specify the condition the block places on the input matrix values. If you select $>$ or \leq , the block outputs 0 or 1 depending on whether the input matrix values are above, below, or equal to the threshold value.

Output threshold

Select this check box to output the calculated threshold values at the Th port.

Output effectiveness metric

Select this check box to output values that represent the effectiveness of the thresholding at the EMetric port.

Specify data range

If you clear this check box, the block assumes that floating-point input values range from 0 to 1. To specify a different data range, select this check box.

Minimum value of input

Enter the minimum value of your input data. This parameter is visible if you select the **Specify data range** check box.

Maximum value of input

Enter the maximum value of your input data. This parameter is visible if you select the **Specify data range** check box.

When data range is exceeded

Specify the block's behavior when the input values are outside the expected range. Your options are Ignore, Saturate, Warn and saturate, or Error. This parameter is visible if you select the **Specify data range** check box.

Scale threshold

Select this check box to scale the threshold value computed by Otsu's method.

Threshold scaling factor

Enter a scalar value. The block multiplies this scalar value with the threshold value computed by Otsu's method and uses the result as the new threshold value. This parameter is visible if you select the **Scale threshold** check box.

Rounding mode

Select the rounding mode for fixed-point operations. This parameter does not apply to the Cast to input DT step shown in "Fixed-Point Data Types" on page 1-99. For this step, **Rounding mode** is always set to Nearest.

Overflow mode

Select the overflow mode for fixed-point operations.

Product 1, 2, 3, 4

As shown previously, the output of the multiplier is placed into the product output data type and scaling. Use this parameter to specify how to designate the product output word and fraction lengths.

- When you select **Specify word length**, you can enter the word length of the product values in bits. The block sets the fraction length to give you the best precision.
- When you select **Same as input**, the characteristics match those of the input to the block. This choice is only available for the **Product 4** parameter.

- When you select **Binary point scaling**, you can enter the word length and the fraction length of the product output in bits.
- When you select **Slope and bias scaling**, you can enter the word length in bits and the slope of the product output. The bias of all signals in the Computer Vision Toolbox software is 0.

Accumulator 1, 2, 3, 4

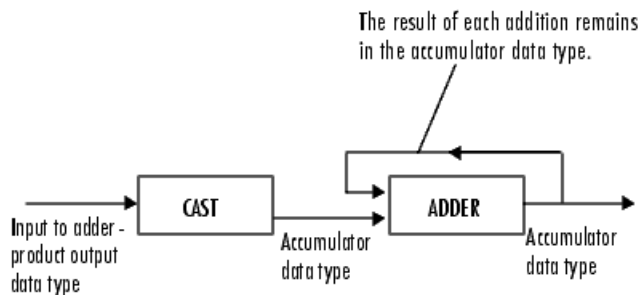

As shown previously, inputs to the accumulator are cast to the accumulator data type. The output of the adder remains in the accumulator data type as each element of the input is added to it. Use this parameter to specify how to designate the accumulator word and fraction lengths.

- When you select **Same as Product**, these characteristics match those of the product output.
- When you select **Specify word length**, you can enter the word length of the accumulator values in bits. The block sets the fraction length to give you the best precision. This choice is not available for the **Accumulator 4** parameter because it is dependent on the input data type.
- When you select **Binary point scaling**, you can enter the word length and the fraction length of the accumulator in bits.
- When you select **Slope and bias scaling**, you can enter the word length in bits and the slope of the accumulator. The bias of all signals in the Computer Vision Toolbox software is 0.

The **Accumulator 3** parameter is only visible if, on the **Main** pane, you select the **Output effectiveness metric** check box.

Quotient

Choose how to specify the word length and fraction length of the quotient data type:

- When you select **Specify word length**, you can enter the word length of the quotient values in bits. The block sets the fraction length to give you the best precision.
- When you select **Binary point scaling**, you can enter the word length and the fraction length of the quotient, in bits.
- When you select **Slope and bias scaling**, you can enter the word length in bits and the slope of the quotient. The bias of all signals in the Computer Vision Toolbox software is 0.

Eff Metric

Choose how to specify the word length and fraction length of the effectiveness metric data type. This parameter is only visible if, on the **Main** tab, you select the **Output effectiveness metric** check box.

- When you select `Specify word length`, you can enter the word length of the effectiveness metric values, in bits. The block sets the fraction length to give you the best precision.
- When you select `Binary point scaling`, you can enter the word length and the fraction length of the effectiveness metric in bits.
- When you select `Slope and bias scaling`, you can enter the word length in bits and the slope of the effectiveness metric. The bias of all signals in the Computer Vision Toolbox software is 0.

Lock data type settings against change by the fixed-point tools

Select this parameter to prevent the fixed-point tools from overriding the data types you specify on the block mask. For more information, see `fxptdlg`, a reference page on the Fixed-Point Tool in the Simulink documentation.

Example

Example 1.1. Thresholding Intensity Images Using the Autothreshold Block

Convert an intensity image into a binary image. Use the Autothreshold block when lighting conditions vary and the threshold needs to change for each video frame.

You can open the example model by typing

```
ex_vision_autothreshold
```

on the MATLAB command line.

See Also

Compare To Constant	Simulink
Relational Operator	Simulink
graythresh	Image Processing Toolbox

Extended Capabilities

C/C++ Code Generation

Generate C and C++ code using Simulink® Coder™.

See Also

Topics

“Detect and Track Face”

Introduced before R2006a

Blob Analysis

Statistics for labeled regions

Library: Computer Vision Toolbox / Statistics

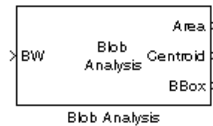

Description

The Blob Analysis block calculates statistics for labeled regions in a binary image. The block returns quantities such as the centroid, bounding box, label matrix, and blob count. The Blob Analysis block supports input and output variable-size signals. You can also use the Selector block from Simulink, to select certain blobs based on their statistics.

For information on pixel and spatial coordinate system definitions, see “Image Coordinate Systems” and “Coordinate Systems”.

Ports

Input

BW — Binary image

vector | matrix

Binary image, specified as a vector or matrix

Data Types: Boolean

Output

Area — Number of pixels in labeled regions

vector

Number of pixels in labeled regions, returned as a vector.

Dependencies

To enable this port, select the **Area** parameter.

Data Types: int32

Centroid — Centroid coordinates

M -by-2 matrix

M -by-2 matrix of M number of blobs.

The rows represent the coordinates of the centroid of each region, and M represents the number of blobs.

For example, there are two blobs where the row and column coordinates of their centroids are x_1 , y_1 and x_2 , y_2 . The block outputs:

$$\begin{bmatrix} x_1 & y_1 \\ x_2 & y_2 \end{bmatrix}$$

at the **Centroid** port.

Dependencies

To enable this port, select the **Centroid** parameter.

Data Types: `double` | `single` | `fixed point`

BBox — Bounding box coordinates

M-by-4 matrix

Bounding box coordinates, returned as an *M*-by-4 matrix of *M* bounding boxes for blobs. Each row of the matrix defines a bounding box as a four-element vector $[x,y,width,height]$ in pixel coordinates. The rows represent the coordinates of each bounding box, where *M* represents the number of blobs.

For example, there are two blobs, where *x* and *y* define the location of the upper-left corner of the bounding box, and *w* and *h* define the width and height of the bounding box. The block outputs

$$\begin{bmatrix} x_1 & y_1 & w_1 & h_1 \\ x_2 & y_2 & w_2 & h_2 \end{bmatrix}$$

at the **BBox** port.

Dependencies

To enable this port, select the **Bounding Box** parameter.

Parameters

Main Tab

Area — Number of pixels in labeled regions

vector

Number of pixels in labeled regions, returned as a vector.

Dependencies

To enable this port, select the **Area** parameter.

Data Types: `int32`

Centroid — Centroid coordinates

M-by-2 matrix

M-by-2 matrix of *M* number of blobs.

The rows represent the coordinates of the centroid of each region, and *M* represents the number of blobs.

For example, there are two blobs where the row and column coordinates of their centroids are x_1 , y_1 and x_2 , y_2 . The block outputs:

$$\begin{bmatrix} x_1 & y_1 \\ x_2 & y_2 \end{bmatrix}$$

at the **Centroid** port.

Dependencies

To enable this port, select the **Centroid** parameter.

Data Types: double | single | fixed point

BBox — Bounding box coordinates

M-by-4 matrix

Bounding box coordinates, returned as an *M*-by-4 matrix of *M* bounding boxes for blobs. Each row of the matrix defines a bounding box as a four-element vector $[x,y,width,height]$ in pixel coordinates. The rows represent the coordinates of each bounding box, where *M* represents the number of blobs.

For example, there are two blobs, where *x* and *y* define the location of the upper-left corner of the bounding box, and *w* and *h* define the width and height of the bounding box. The block outputs

$$\begin{bmatrix} x_1 & y_1 & w_1 & h_1 \\ x_2 & y_2 & w_2 & h_2 \end{bmatrix}$$

at the **BBox** port.

Dependencies

To enable this port, select the **Bounding Box** parameter.

Major axis length — Length of major axis of ellipses

off (default) | on

Enables the **Major axis length** port. Select this check box to output a vector that

- Represents the lengths of the major axes of ellipses
- Has the same normalized second central moments as the labeled regions

Data Types: double | single

Minor axis length — Length of minor axis of ellipses

off (default) | on

Enables the **Minor axis length** port. Select this check box to output a vector that

- Represents the lengths of the minor axes of ellipses
- Has the same normalized second central moments as the labeled regions

Data Types: double | single

Orientation — Orientation

off (default) | on

Enables the **Orientation** port.

Select this check box to output a vector that represents the angles between the major axes of the ellipses and the x-axis. The angle values are in radians and range between: $-\frac{\pi}{2}$ and $\frac{\pi}{2}$ inclusive.

Data Types: double | single

Eccentricity – Eccentricity

off (default) | on

Enables the **Eccentricity** port. Select this check box to output a vector that represents the eccentricities of ellipses that have the same second moments as the region.

Data Types: double | single

Equivalent diameter squared – Equivalent diameter squared

off (default) | on

Enables the **Equivalent diameter squared** port. Select this check box to output a vector that represents the equivalent diameters squared.

Data Types: double | single | fixed point

Extent – Extent

off (default) | on

Enables the **Extent** port. Select this check box to output a vector that represents the results of dividing the areas of the blobs by the area of their bounding boxes.

Data Types: double | single | fixed point

Perimeter – Perimeter length

off (default) | on

Enables the **Perimeter** port. Select this check box to output an N -by-1 vector of the perimeter lengths, in pixels, of each blob, where N is the number of blobs.

Data Types: double | single | fixed point

Statistics output data type – Output data type

double (default) | single | Specify via Data Types tab

Specify the data type of the outputs as double, single, or Specify via Data Types tab.

Data Types: double | single

Connectivity – Number of labeled regions

8 (default) | 4

Specify the number of labeled regions in each image.

Define which pixels connect to each other. If you want to connect pixels located on the top, bottom, left, and right, select 4. If you want to connect pixels to other pixels on the top, bottom, left, right, and diagonally, select 8. For more information about this parameter, see the Label block.

The **Connectivity** parameter also affects how the block calculates the perimeter of a blob. For example, this figure illustrates how the block calculates the perimeter when you set the **Connectivity** parameter to 4.

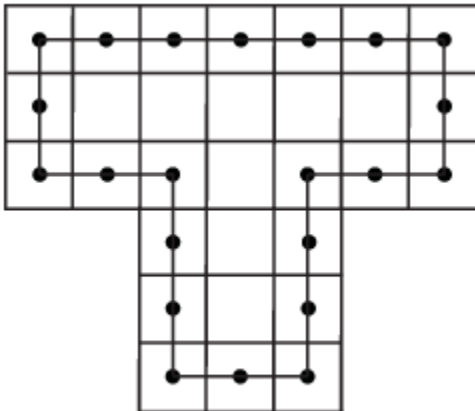

The block calculates the distance between the center of each pixel (marked by the black dots) and estimates the perimeter to be 22.

The next figure illustrates how the block calculates the perimeter of a blob when you set the **Connectivity** parameter to 8.

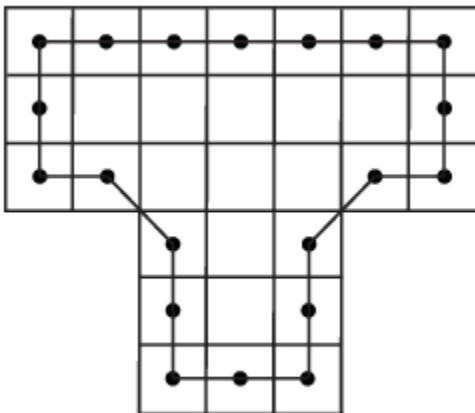

The block takes a different path around the blob and estimates the perimeter to be $18 + 2\sqrt{2}$.

Data Types: double | single

Output label matrix – Output label matrix

off (default) | on

Enable the **Label** port. Select this check box to output the label matrix. The pixels equal to 0 represent the background. The pixels equal to 1 represent the first object. The pixels equal to 2 represent the second object, and so on.

Blob Properties Tab

Maximum number of blobs – Maximum number of blobs

scalar

Specify the maximum number of labeled regions in each input image. The block uses this value to preallocate vectors and matrices to ensure that they are long enough to hold the statistical values.

The maximum number of blobs the block outputs depends on both the value of this parameter and the size of the input image. The number of blobs the block outputs may be limited by the input image size.

Warn if maximum number of blobs is exceeded — Warn if maximum number of blobs is exceeded

on (default) | off

Select this parameter to warn if maximum number of blobs is exceeded.

Output actual number of blobs — Number of blobs

off (default) | on

Enable the **Count** port. Select this parameter to output a scalar value that represents the actual number of connected regions in each image.

Specify minimum blob area in pixels — Minimum blob area in pixels

0 (default) | scalar

Select this parameter to specify the minimum blob area in pixels. The blob is labeled if the number of pixels meets the minimum size specified.

Tunable: Yes

Specify maximum blob area in pixels — Maximum blob area in pixels

intmax('uint32') (default) | scalar

Select this parameter to specify the maximum blob area in pixels. The blob is labeled if the number of pixels meets the maximum size specified. The maximum allowable value is the maximum of the uint32 data type.

Tunable: Yes

Exclude blobs touching image border — Exclude blobs touching image border

off (default) | on

Specify this parameter to exclude a labeled blob that contains at least one border pixel.

Output blob statistics as a variable size signal — Output blob statistics as a variable size signal

off (default) | on

Specify this parameter to output blob statistics as a variable-size signal.

Fill empty spaces in output — Fill empty spaces in output

off (default) | on

Specify this parameter to fill empty spaces in the statistical vectors with the values you specify in the **Fill values** parameter.

Dependencies

To enable this parameter, clear the **Output blob statistics as a variable size signal** parameter.

Fill values — Scalar used to fill empty spaces in output

-1 (default) | scalar | vector

Specify a scalar value to fill all the empty spaces in the statistical vectors. If you enter a vector, it must have the same length as the number of selected statistics. The block uses each vector element to fill a different statistics vector. If the empty spaces do not affect your computation, you can clear the **Fill empty spaces in outputs** parameter.

Dependencies

To enable this parameter, clear the **Output blob statistics as a variable size signal** parameter.

Data Types Tab

To enable option on the **Data Types** tab, in the **Main** tab, set the **Statistics output data type** parameter to **Specify via Data Types** tab. For details on the fixed-point block parameters, see “Specify Fixed-Point Attributes for Blocks”.

Block Characteristics

Data Types	Boolean ^a double ^b fixed point ^{bc} integer ^b single ^b
Multidimensional Signals	no
Variable-Size Signals	yes

- Generated code will be restricted to MATLAB host computers when you set the FFT implementation parameter to FFTW, or when the transform length is not a power of two.
- This data type is supported at the output port(s).
- Fixed-point data types are not supported at the Major Axis, Minor Axis, Orientation, and Eccentricity output ports.

Extended Capabilities

C/C++ Code Generation

Generate C and C++ code using Simulink® Coder™.

Fixed-Point Conversion

Design and simulate fixed-point systems using Fixed-Point Designer™.

See Also

Label | regionprops

Topics

“Cell Counting”

Introduced before R2006a

Block Matching

Estimate motion between images or video frames

Library: Computer Vision Toolbox / Analysis & Enhancement

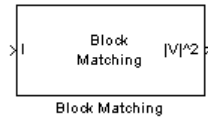

Description

The Block Matching block estimates motion between two images or two video frames by comparing blocks of pixels. The block matches the block of pixels between frames by moving the block of pixels over a search region.

Ports

Input

I/I1 — Image or video frame

scalar | vector | matrix

Image or video frame, specified as a scalar, vector, or matrix. If the Estimate motion between parameter is set to Two images, the name of this port changes to **I1**.

Data Types: single | double | int8 | int16 | int32 | int64 | uint8 | uint16 | uint32 | uint64 | fixed point

I2 — Image or video frame

scalar | vector | matrix

Image or video frame, specified as a scalar, vector, or matrix.

Dependencies

To enable this port, set the **Estimate motion between** parameter to Two images.

Data Types: single | double | int8 | int16 | int32 | int64 | uint8 | uint16 | uint32 | uint64 | fixed point

Output

|V|^2 — Velocity magnitudes

scalar | vector | matrix

Velocity magnitudes, returned as a scalar, vector, or matrix.

Data Types: single | double | int8 | int16 | int32 | int64 | uint8 | uint16 | uint32 | uint64 | fixed point

V — Velocity components in complex form

scalar | vector | matrix

Velocity components in complex form, returned as a scalar, vector, or matrix.

Dependencies

To expose this port, set the **Velocity output** parameter to `Horizontal` and `vertical` components in complex form.

Data Types: `single` | `double` | `int8` | `int16` | `int32` | `int64` | `uint8` | `uint16` | `uint32` | `uint64` | `fixed point`

Parameters

Main Tab

Estimate motion between — Estimate motion between images or frames

`Current frame and N-th frame back (default)` | `Two images`

Specify whether to estimate the motion between two images or two video frames. Select `Two images` to estimate the motion between two images. Select `Current frame and N-th frame back` to estimate the motion between two video frames that are N frames apart.

Dependencies

Set this parameter to `Current frame and N-th frame back` to expose the `N` parameter.

N — Number of frames

`1 (default)` | `scalar`

Specify a scalar value that represents the number of frames between the reference frame and the current frame.

Dependencies

To enable this parameter, set the **Estimate motion between** parameter to `Current frame and N-th frame back`.

Search method — Block match search method

`Exhaustive (default)` | `Three-step`

Specify how the block locates the block of pixels in the current frame and the next frame that best matches the block of pixels.

- **Exhaustive** — The block selects the location of the block of pixels in the next frame by moving the block over the search region one pixel at a time. This process is computationally expensive.
- **Three-step** — The block searches for the block of pixels in the next frame that best matches the block of pixels in the current frame by using a steadily decreasing step size. The block begins with a step size approximately equal to half the maximum search range. In each step, the block compares the central point of the search region to eight search points located on the boundaries of the region and moves the central point to the search point whose values is the closest to that of the central point. The block then reduces the step size by half, and begins the process again. This option is less computationally expensive, though it might not find the optimal solution.

Block matching criteria — Block matching criteria

`Mean square error (MSE) (default)` | `Mean absolute difference (MAD)`

Specify how the block measures the similarity of the block of pixels in the current frame to the block of pixels in the next frame.

If you select **Mean square error (MSE)**, the block estimates the displacement of the center pixel of the block as the (d_1, d_2) values that minimize this MSE equation:

$$MSE(d_1, d_2) = \frac{1}{N_1 \times N_2} \sum_{(n_1, n_2) \in B} [s(n_1, n_2, k) - s(n_1 + d_1, n_2 + d_2, k + 1)]^2$$

In the previous equation, B is an $N_1 \times N_2$ block of pixels, and $s(x,y,k)$ denotes a pixel location at (x,y) in frame k .

If you select **Mean absolute difference (MAD)**, the Block Matching block estimates the displacement of the center pixel of the block as the (d_1, d_2) values that minimize this MAD equation:

$$MAD(d_1, d_2) = \frac{1}{N_1 \times N_2} \sum_{(n_1, n_2) \in B} |s(n_1, n_2, k) - s(n_1 + d_1, n_2 + d_2, k + 1)|$$

Block size [height width] – Block size

[17 17] (default) | two-element vector

Specify the size of the block of pixels.

Overlap size [r c] – Block overlap

[0 0] (default) | two-element vector

Specify the overlap (in pixels) of two subdivisions of the input image.

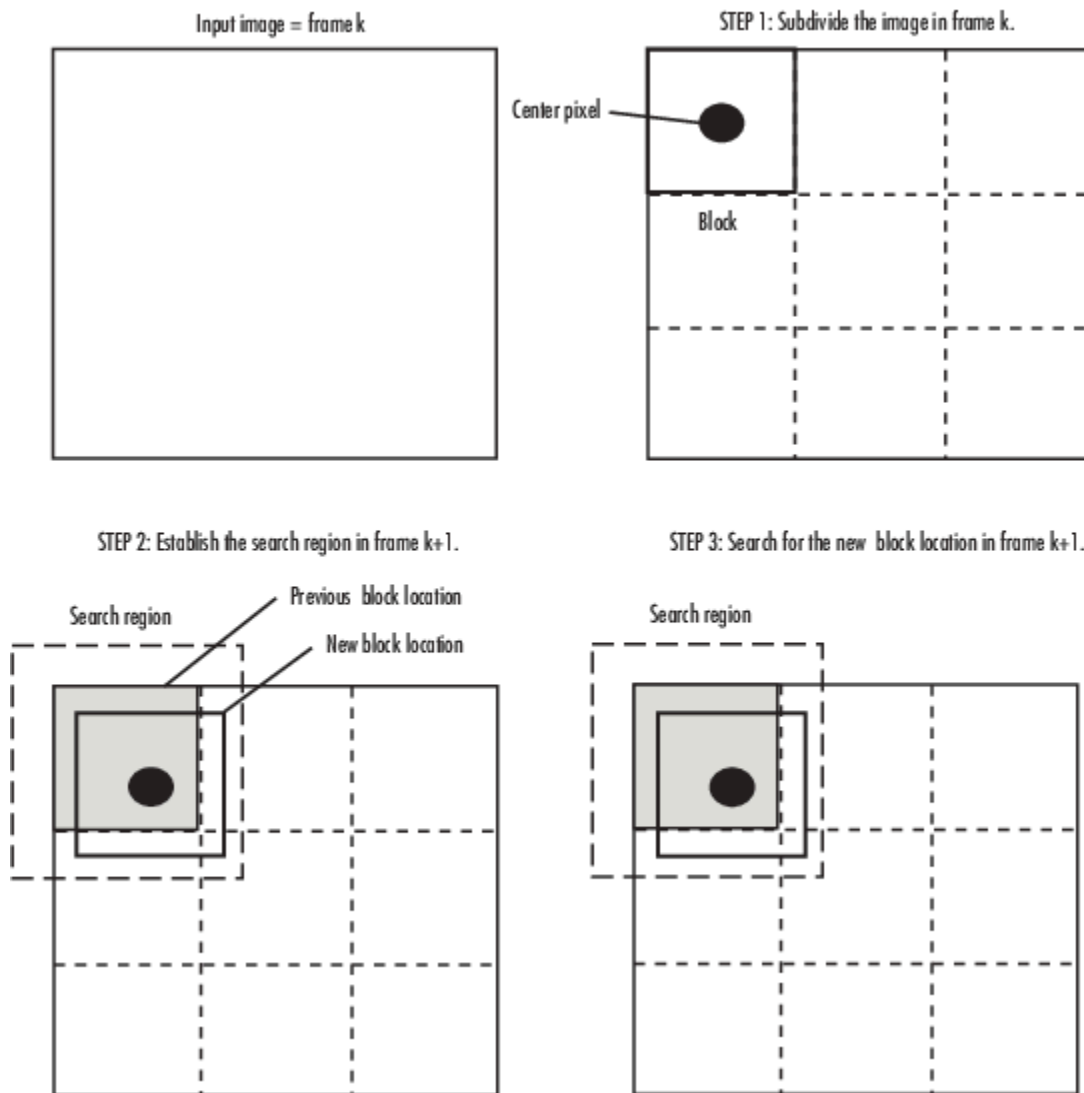

Maximum displacement [r c] – Maximum displacement

[7 7] (default) | two-element vector

Specify the maximum number of pixels any center pixel in a block of pixels might move from image to image or frame to frame. The block uses this value to determine the size of the search region.

Velocity output – Velocity output

Magnitude-squared (default) | Horizontal and vertical components in complex form

Specify the output. If you select **Magnitude-squared**, the block outputs an optical flow matrix where each element is in the form u^2+v^2 . If you select **Horizontal and vertical components in complex form**, the block outputs an optical flow matrix where each element is in the form $u + jv$. The real part of each value is the horizontal velocity component and the imaginary part of each value is the vertical velocity component.

Data Types Tab

For details on the fixed-point block parameters, see “Specify Fixed-Point Attributes for Blocks”.

Block Characteristics

Data Types	double fixed point integer single
Multidimensional Signals	no
Variable-Size Signals	no

Algorithms

Block Matching Search

Suppose the input to the block is frame k . The block performs the following steps:

- 1 Subdivide the frame using the values for the **Block size [height width]** and **Overlap size [r c]** parameters. For this example, **Overlap size [r c]** equals [0 0].
- 2 For each subdivision or block in frame $k+1$, a search region is established based on the value of the **Maximum displacement [r c]** parameter.
- 3 Search for the new block location using either the Exhaustive or Three-step search method.

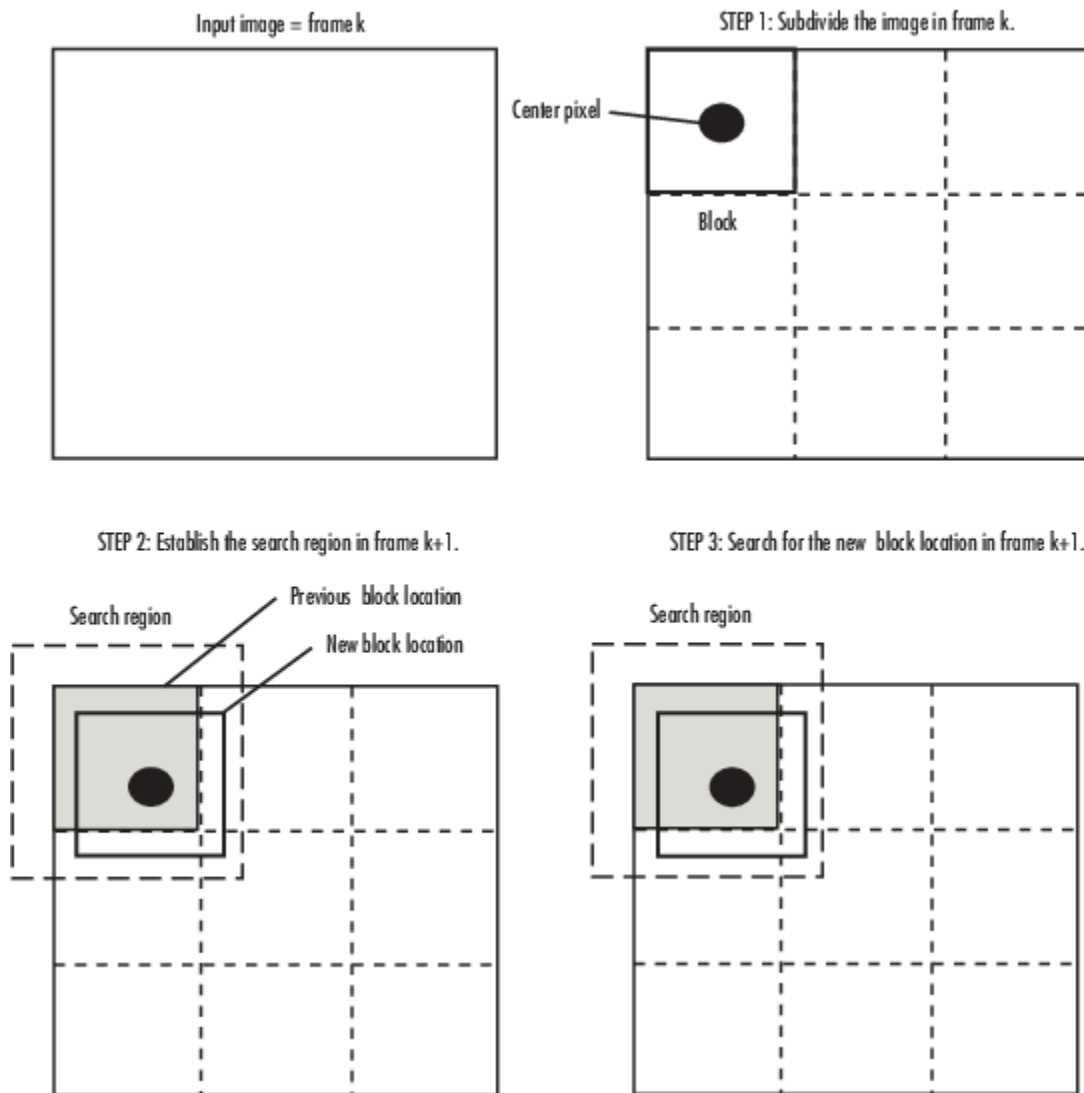

Extended Capabilities

C/C++ Code Generation

Generate C and C++ code using Simulink® Coder™.

Fixed-Point Conversion

Design and simulate fixed-point systems using Fixed-Point Designer™.

See Also

Optical Flow | `opticalFlow` | `opticalFlowHS` | `opticalFlowLK` | `opticalFlowLKDoG`

Introduced before R2006a

Block Processing

Repeat user-specified operation on submatrices of input matrix

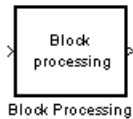

Library

Utilities

visionutilities

Description

The Block Processing block extracts submatrices of a user-specified size from each input matrix. It sends each submatrix to a subsystem for processing, and then reassembles each subsystem output into the output matrix.

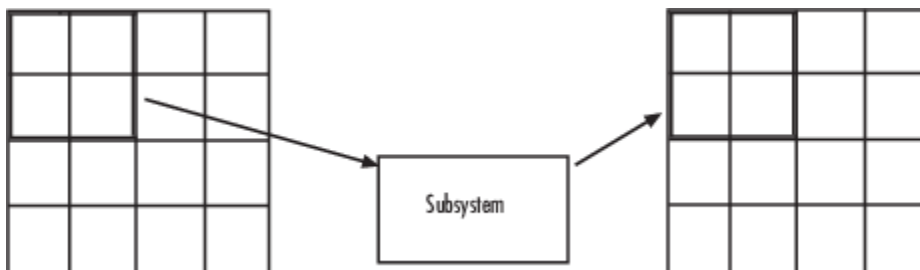

Note Because you modify the Block Processing block's subsystem, the link between this block and the block library is broken when you click-and-drag a Block Processing block into your model. As a result, this block will not be automatically updated if you upgrade to a newer version of the Computer Vision Toolbox software. If you right-click on the block and select **Mask>Look Under Mask**, you can delete blocks from this subsystem without triggering a warning. Lastly, if you search for library blocks in a model, this block will not be part of the results.

The blocks inside the subsystem dictate the frame status of the input and output signals, whether single channel or multichannel signals are supported, and which data types are supported by this block.

Use the **Number of inputs** and **Number of outputs** parameters to specify the number of input and output ports on the Block Processing block.

Use the **Block size** parameter to specify the size of each submatrix in cell array format. Each vector in the cell array corresponds to one input; the block uses the vectors in the order you enter them. If you have one input port, enter one vector. If you have more than one input port, you can enter one

vector that is used for all inputs or you can specify a different vector for each input. For example, if you want each submatrix to be 2-by-3, enter `{[2 3]}`.

Use the **Overlap** parameter to specify the overlap of each submatrix in cell array format. Each vector in the cell array corresponds to the overlap of one input; the block uses the vectors in the order they are specified. If you enter one vector, each overlap is the same size. For example, if you want each 3-by-3 submatrix to overlap by 1 row and 2 columns, enter `{[1 2]}`.

The **Traverse order** parameter determines how the block extracts submatrices from the input matrix. If you select **Row-wise**, the block extracts submatrices by moving across the rows. If you select **Column-wise**, the block extracts submatrices by moving down the columns.

Click the **Open Subsystem** button to open the block's subsystem. Click-and-drag blocks into this subsystem to define the processing operation(s) the block performs on the submatrices. The input to this subsystem are the submatrices whose size is determined by the **Block size** parameter.

Note When you place an Assignment block inside a Block Processing block's subsystem, the Assignment block behaves as though it is inside a For Iterator block. For a description of this behavior, see the "Iterated Assignment" section of the Assignment block reference page.

Parameters

Number of inputs

Enter the number of input ports on the Block Processing block.

Add port to supply subsystem parameters

Add an input port to the block to supply subsystem parameters. When you check this option, a port (**P**) is added to the block.

Number of outputs

Enter the number of output ports on the Block Processing block.

Block size

Specify the size of each submatrix in cell array format. Each vector in the cell array corresponds to one input.

Overlap

Specify the overlap of each submatrix in cell array format. Each vector in the cell array corresponds to the overlap of one input.

Traverse order

Determines how the block extracts submatrices from the input matrix. If you select **Row-wise**, the block extracts submatrices by moving across the rows. If you select **Column-wise**, the block extracts submatrices by moving down the columns.

Open Subsystem

Click this button to open the block's subsystem. Click-and-drag blocks into this subsystem to define the processing operation(s) the block performs on the submatrices.

See Also

For Iterator	Simulink
--------------	----------

blockproc	Image Processing Toolbox
-----------	--------------------------

See Also

Topics

“Video Compression”

Introduced before R2006a

Bottom-hat

Perform bottom-hat filtering on intensity or binary images

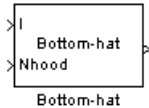

Library

Morphological Operations

visionmorphops

Description

Use the Bottom-hat block to perform bottom-hat filtering on an intensity or binary image using a predefined neighborhood or structuring element. Bottom-hat filtering is the equivalent of subtracting the input image from the result of performing a morphological closing operation on the input image. This block uses flat structuring elements only.

Port	Input/Output	Supported Data Types	Complex Values Supported
	Vector or matrix of intensity values	<ul style="list-style-type: none"> • Double-precision floating point • Single-precision floating point • Fixed point • Boolean • 8-, 16-, and 32-bit signed integer • 8-, 16-, and 32-bit unsigned integer 	No
Nhood	Matrix or vector of ones and zeros that represents the neighborhood values	Boolean	No
Output	Scalar, vector, or matrix that represents the filtered image	Same as I port	No

If your input image is a binary image, for the **Input image type** parameter, select **Binary**. If your input image is an intensity image, select **Intensity**.

Use the **Neighborhood or structuring element source** parameter to specify how to enter your neighborhood or structuring element values. If you select **Specify via dialog**, the **Neighborhood or structuring element** parameter appears in the dialog box. If you select **Input port**, the Nhood port appears on the block. Use this port to enter your neighborhood values as a matrix or vector of 1s and 0s. You can only specify a structuring element using the dialog box.

Use the **Neighborhood or structuring element** parameter to define the region the block moves throughout the image. Specify a neighborhood by entering a matrix or vector of 1s and 0s. Specify a

structuring element with the `strel` function from the Image Processing Toolbox. If the structuring element is decomposable into smaller elements, the block executes at higher speeds due to the use of a more efficient algorithm.

Parameters

Input image type

If your input image is a binary image, select **Binary**. If your input image is an intensity image, select **Intensity**.

Neighborhood or structuring element source

Specify how to enter your neighborhood or structuring element values. Select **Specify via dialog** to enter the values in the dialog box. Select **Input port** to use the Nhood port to specify the neighborhood values. You can only specify a structuring element using the dialog box.

Neighborhood or structuring element

If you are specifying a neighborhood, this parameter must be a matrix or vector of 1s and 0s. If you are specifying a structuring element, use the `strel` function from the Image Processing Toolbox. This parameter is visible if, for the **Neighborhood or structuring element source** parameter, you select **Specify via dialog**.

See Also

Closing	Computer Vision Toolbox software
Dilation	Computer Vision Toolbox software
Erosion	Video and Image Processing Blockset software
Label	Computer Vision Toolbox software
Opening	Computer Vision Toolbox software
Top-hat	Computer Vision Toolbox software
imbothat	Image Processing Toolbox software
<code>strel</code>	Image Processing Toolbox software

Extended Capabilities

C/C++ Code Generation

Generate C and C++ code using Simulink® Coder™.

Introduced before R2006a

Chroma Resampling

Downsample or upsample chrominance components of images

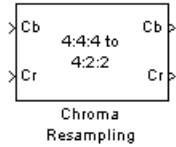

Library

Conversions

visionconversions

Description

The Chroma Resampling block downsamples or upsamples chrominance components of pixels to reduce the bandwidth required for transmission or storage of a signal.

Port	Input/Output	Supported Data Types	Complex Values Supported
Cb	Matrix that represents one chrominance component of an image	<ul style="list-style-type: none"> Double-precision floating point Single-precision floating point 8-bit unsigned integer 	No
Cr	Matrix that represents one chrominance component of an image	Same as Cb port	No

The data type of the output signals is the same as the data type of the input signals.

Chroma Resampling Formats

The Chroma Resampling block supports the formats shown in the following diagram.

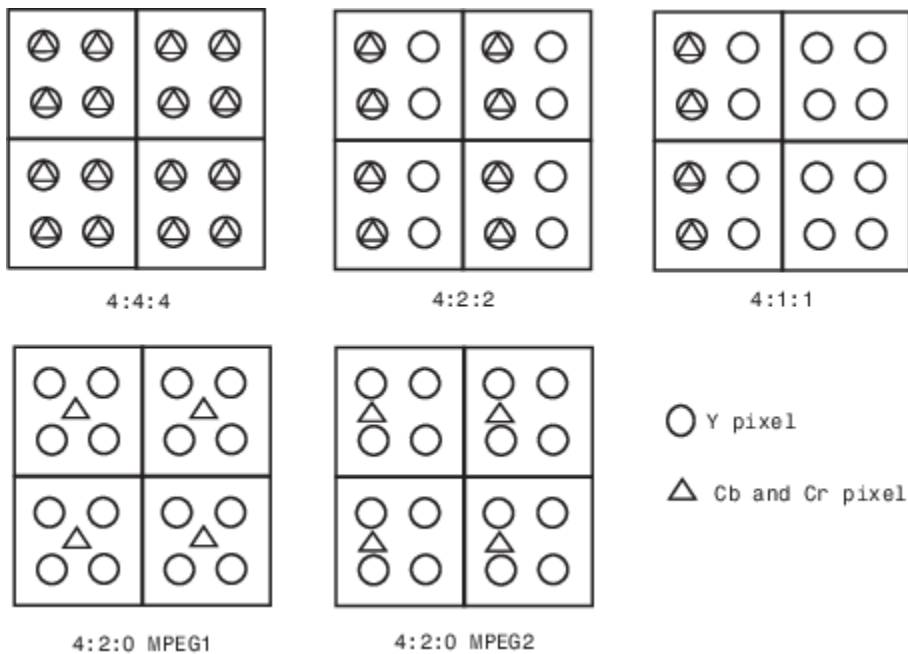

Downsampling

If, for the **Resampling** parameter, you select 4:4:4 to 4:2:2, 4:4:4 to 4:2:0 (MPEG1), 4:4:4 to 4:2:0 (MPEG2), 4:4:4 to 4:1:1, 4:2:2 to 4:2:0 (MPEG1), or 4:2:2 to 4:2:0 (MPEG2), the block performs a downsampling operation. When the block downsamples from one format to another, it can bandlimit the input signal by applying a lowpass filter to prevent aliasing.

If, for the **Antialiasing filter** parameter, you select Default, the block uses a built-in lowpass filter to prevent aliasing.

If, for the **Resampling** parameter, you select 4:4:4 to 4:2:2, 4:4:4 to 4:2:0 (MPEG1), 4:4:4 to 4:2:0 (MPEG2), or 4:4:4 to 4:1:1 and, for the **Antialiasing filter** parameter, you select User-defined, the **Horizontal filter coefficients** parameter appears on the dialog box. Enter the filter coefficients to apply to your input.

If, for the **Resampling** parameter, you select 4:4:4 to 4:2:0 (MPEG1), 4:4:4 to 4:2:0 (MPEG2), 4:2:2 to 4:2:0 (MPEG1), or 4:2:2 to 4:2:0 (MPEG2) and, for the **Antialiasing filter** parameter, you select User-defined. **Vertical filter coefficients** parameters appear on the dialog box. Enter an even number of filter coefficients to apply to your input signal.

If, for the **Antialiasing filter** parameter, you select None, the block does not filter the input signal.

Upsampling

If, for the **Resampling** parameter, you select 4:2:2 to 4:4:4, 4:2:0 (MPEG1) to 4:2:2, 4:2:0 (MPEG1) to 4:4:4, 4:2:0 (MPEG2) to 4:2:2, 4:2:0 (MPEG2) to 4:4:4, or 4:1:1 to 4:4:4, the block performs an upsampling operation.

When the block upsamples from one format to another, it uses interpolation to approximate the missing chrominance values. If, for the **Interpolation** parameter, you select Linear, the block uses

linear interpolation to calculate the missing values. If, for the **Interpolation** parameter, you select **Pixel replication**, the block replicates the chrominance values of the neighboring pixels to create the upsampled image.

Row-Major Data Format

The MATLAB environment and the Computer Vision Toolbox software use column-major data organization. However, the Chroma Resampling block gives you the option to process data that is stored in row-major format. When you select the **Input image is transposed (data order is row major)** check box, the block assumes that the input buffer contains contiguous data elements from the first row first, then data elements from the second row second, and so on through the last row. Use this functionality only when you meet all the following criteria:

- You are developing algorithms to run on an embedded target that uses the row-major format.
- You want to limit the additional processing required to take the transpose of signals at the interfaces of the row-major and column-major systems.

When you use the row-major functionality, you must consider the following issues:

- When you select this check box, the signal dimensions of the Chroma Resampling block's input are swapped.
- All the Computer Vision Toolbox blocks can be used to process data that is in the row-major format, but you need to know the image dimensions when you develop your algorithms.

For example, if you use the 2-D FIR Filter block, you need to verify that your filter coefficients are transposed. If you are using the Rotate block, you need to use negative rotation angles, etc.

- Only three blocks have the **Input image is transposed (data order is row major)** check box. They are the Chroma Resampling, Deinterlacing, and Insert Text blocks. You need to select this check box to enable row-major functionality in these blocks. All other blocks must be properly configured to process data in row-major format.

Use the following two-step workflow to develop algorithms in row-major format to run on an embedded target.

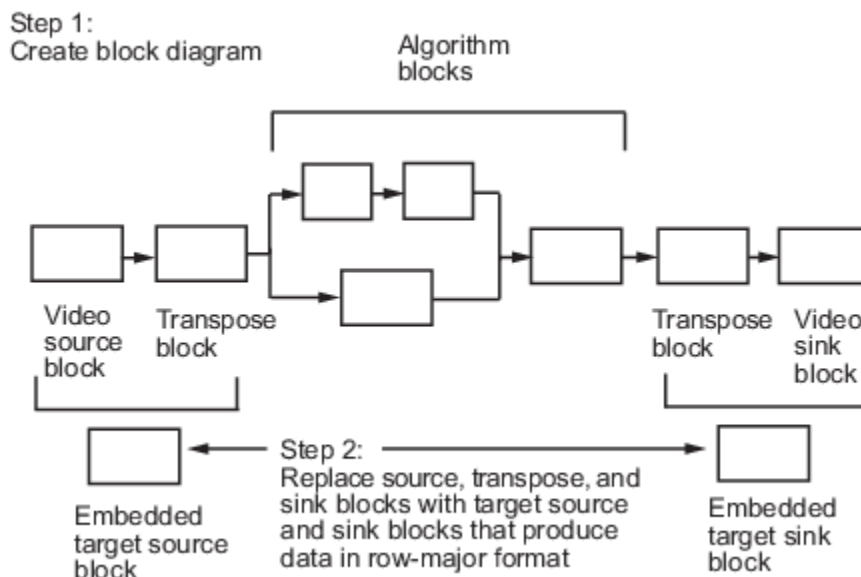

Parameters

Resampling

Specify the resampling format.

Antialiasing filter

Specify the lowpass filter that the block uses to prevent aliasing. If you select `Default`, the block uses a built-in lowpass filter. If you select `User-defined`, the **Horizontal filter coefficients** and/or **Vertical filter coefficients** parameters appear on the dialog box. If you select `None`, the block does not filter the input signal. This parameter is visible when you are downsampling the chrominance values.

Horizontal filter coefficients

Enter the filter coefficients to apply to your input signal. This parameter is visible if, for the **Resampling** parameter, you select `4:4:4 to 4:2:2`, `4:4:4 to 4:2:0 (MPEG1)`, `4:4:4 to 4:2:0 (MPEG2)`, or `4:4:4 to 4:1:1` and, for the **Antialiasing filter** parameter, you select `User-defined`.

Vertical filter coefficients

Enter the filter coefficients to apply to your input signal. This parameter is visible if, for the **Resampling** parameter, you select `4:4:4 to 4:2:0 (MPEG1)`, `4:4:4 to 4:2:0 (MPEG2)`, `4:2:2 to 4:2:0 (MPEG1)`, or `4:2:2 to 4:2:0 (MPEG2)` and, for the **Antialiasing filter** parameter, you select `User-defined`.

Interpolation

Specify the interpolation method that the block uses to approximate the missing chrominance values. If you select `Linear`, the block uses linear interpolation to calculate the missing values. If you select `Pixel replication`, the block replicates the chrominance values of the neighboring pixels to create the upsampled image. This parameter is visible when you are upsampling the chrominance values. This parameter is visible if the **Resampling** parameter is set to `4:2:2 to 4:4:4`, `4:2:0 (MPEG1) to 4:4:4`, `4:2:0 (MPEG2) to 4:4:4`, `4:1:1 to 4:4:4`, `4:2:0 (MPEG1) to 4:2:2`, or `4:2:0 (MPEG2) to 4:2:2`.

Input image is transposed (data order is row major)

When you select this check box, the block assumes that the input buffer contains data elements from the first row first, then data elements from the second row second, and so on through the last row.

References

- [1] Haskell, Barry G., Atul Puri, and Arun N. Netravali. *Digital Video: An Introduction to MPEG-2*. New York: Chapman & Hall, 1996.
- [2] Recommendation ITU-R BT.601-5, Studio Encoding Parameters of Digital Television for Standard 4:3 and Wide Screen 16:9 Aspect Ratios.
- [3] Wang, Yao, Jorn Ostermann, Ya-Qin Zhang. *Video Processing and Communications*. Upper Saddle River, NJ: Prentice Hall, 2002.

See Also

Autothreshold	Computer Vision Toolbox software
---------------	----------------------------------

Color Space Conversion	Computer Vision Toolbox software
Image Complement	Computer Vision Toolbox software

Extended Capabilities

C/C++ Code Generation

Generate C and C++ code using Simulink® Coder™.

Introduced before R2006a

Closing

Perform morphological closing on binary or intensity images

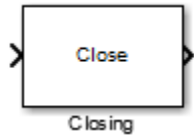

Library

Morphological Operations

visionmorphops

Description

The Closing block performs a dilation operation followed by an erosion operation using a predefined neighborhood or structuring element. This block uses flat structuring elements only.

Port	Input/Output	Supported Data Types	Complex Values Supported
	Vector or matrix of intensity values	<ul style="list-style-type: none"> • Double-precision floating point • Single-precision floating point • Fixed point • Boolean • 8-, 16-, and 32-bit signed integer • 8-, 16-, and 32-bit unsigned integer 	No
Nhood	Matrix or vector of ones and zeros that represents the neighborhood values	Boolean	No
Output	Vector or matrix of intensity values that represents the closed image	Same as I port	No

The output signal has the same data type as the input to the I port.

Use the **Neighborhood or structuring element source** parameter to specify how to enter your neighborhood or structuring element values. If you select *Specify via dialog*, the **Neighborhood or structuring element** parameter appears in the dialog box. If you select *Input port*, the Nhood port appears on the block. Use this port to enter your neighborhood values as a matrix or vector of 1s and 0s. You can only specify a structuring element using the dialog box.

Use the **Neighborhood or structuring element** parameter to define the region the block moves throughout the image. Specify a neighborhood by entering a matrix or vector of 1s and 0s. Specify a structuring element with the `strel` function from the Image Processing Toolbox. If the structuring element is decomposable into smaller elements, the block executes at higher speeds due to the use of a more efficient algorithm.

Parameters

Neighborhood or structuring element source

Specify how to enter your neighborhood or structuring element values. Select **Specify via dialog** to enter the values in the dialog box. Select **Input port** to use the Nhood port to specify the neighborhood values. You can only specify a structuring element using the dialog box.

Neighborhood or structuring element

If you are specifying a neighborhood, this parameter must be a matrix or vector of 1s and 0s. If you are specifying a structuring element, use the `strel` function from the Image Processing Toolbox. This parameter is visible if, for the **Neighborhood or structuring element source** parameter, you select **Specify via dialog**.

References

[1] Soille, Pierre. *Morphological Image Analysis*. 2nd ed. New York: Springer, 2003.

See Also

Bottom-hat	Computer Vision Toolbox software
Dilation	Computer Vision Toolbox software
Erosion	Computer Vision Toolbox software
Label	Computer Vision Toolbox software
Opening	Computer Vision Toolbox software
Top-hat	Computer Vision Toolbox software
<code>imclose</code>	Image Processing Toolbox software
<code>strel</code>	Image Processing Toolbox software

Extended Capabilities

C/C++ Code Generation

Generate C and C++ code using Simulink® Coder™.

Introduced before R2006a

Color Space Conversion

Convert color information between color spaces

Library: Computer Vision Toolbox / Conversions



Description

The Color Space Conversion block converts color information between color spaces. Use the **Conversion** parameter to specify the color spaces you are converting between.

- R'G'B' to Y'CbCr
- Y'CbCr to R'G'B'
- R'G'B' to intensity
- R'G'B' to HSV
- HSV to R'G'B'
- sR'G'B' to XYZ
- XYZ to sR'G'B'
- sR'G'B' to L*a*b*
- L*a*b* to sR'G'B'

Ports

Input

Input — Input

M-by-*N*-by-*P* color matrix

Input color information, specified as an *M*-by-*N*-by-*P* color matrix of *P* color planes.

Data Types: single | double | int8 | uint8

R' — R plane

M-by-*N* matrix

R plane of the RGB color information, specified as an *M*-by-*N* matrix.

Data Types: single | double | int8 | uint8

G' — G plane

M-by-*N* matrix

G plane of the RGB color information, specified as an *M*-by-*N* matrix.

Data Types: single | double | int8 | uint8

B' — B plane

M-by-*N* matrix

B plane of the RGB color information, specified as an M -by- N matrix.

Data Types: `single` | `double` | `int8` | `uint8`

Y' — Luma signal component

M -by- N matrix

Luma signal component, specified as an M -by- N matrix.

Data Types: `single` | `double` | `int8` | `uint8`

Cb — Chrominance component

M -by- N matrix

Chrominance component, specified as an M -by- N matrix.

Data Types: `single` | `double` | `int8` | `uint8`

Cr — Chrominance component

M -by- N matrix

Chrominance component, specified as an M -by- N matrix.

Data Types: `single` | `double` | `int8` | `uint8`

I' — Intensity values

M -by- N -by- P color video

Intensity values specified as an M -by- N matrix.

Data Types: `single` | `double` | `int8` | `uint8`

H — Hue component

M -by- N matrix

Hue component, specified as an M -by- N matrix.

Data Types: `single` | `double`

S — Saturation component

M -by- N matrix

Saturation component, specified as an M -by- N matrix.

Data Types: `single` | `double`

V — Brightness component

M -by- N matrix

Brightness component, specified as an M -by- N matrix.

Data Types: `single` | `double`

X — X component

M -by- N matrix

X component, specified as an M -by- N matrix.

Data Types: `single` | `double`

Y — Y component

M-by-*N* matrix

Y component, specified as an *M*-by-*N* matrix.

Data Types: single | double

Z — Z component

M-by-*N* matrix

Z component, specified as an *M*-by-*N* matrix.

Data Types: single | double

L* — Luminance portion

M-by-*N* matrix

Luminance component, specified as an *M*-by-*N* matrix.

Data Types: single | double

a* — a* component

M-by-*N* matrix

a* component, specified as an *M*-by-*N* matrix.

Data Types: single | double

b* — b* component

M-by-*N* matrix

b* component, specified as an *M*-by-*N* matrix.

Data Types: single | double

Output**Input — Input**

M-by-*N*-by-*P* color matrix

Input color information, specified as an *M*-by-*N*-by-*P* color matrix of *P* color planes.

- If the input is `uint8`, then $Y'CbCr$ is `uint8`, where Y is in the range [16 235], and Cb and Cr are in the range [16 240].
- If the input is a `double`, then Y' is in the range [16/255 235/255] and Cb and Cr are in the range [16/255 240/255].

Data Types: single | double | int8 | uint8

R' — R plane

M-by-*N* matrix

R plane of the RGB color information, specified as an *M*-by-*N* matrix.

Data Types: single | double | int8 | uint8

G' — G plane

M-by-*N* matrix

G plane of the RGB color information, specified as an M -by- N matrix.

Data Types: `single` | `double` | `int8` | `uint8`

B' — B plane

M -by- N matrix

B plane of the RGB color information, specified as an M -by- N matrix.

Data Types: `single` | `double` | `int8` | `uint8`

Y' — Luma signal component

M -by- N matrix

Luma signal component, specified as an M -by- N matrix.

Data Types: `single` | `double` | `int8` | `uint8`

Cb — Chrominance component

M -by- N matrix

Chrominance component, specified as an M -by- N matrix.

Data Types: `single` | `double` | `int8` | `uint8`

Cr — Chrominance component

M -by- N matrix

Chrominance component, specified as an M -by- N matrix.

Data Types: `single` | `double` | `int8` | `uint8`

I' — Intensity values

M -by- N -by- P color video

Intensity values specified as an M -by- N matrix.

Data Types: `single` | `double` | `int8` | `uint8`

H — Hue component

M -by- N matrix

Hue component, specified as an M -by- N matrix.

Data Types: `single` | `double`

S — Saturation component

M -by- N matrix

Saturation component, specified as an M -by- N matrix.

Data Types: `single` | `double`

V — Brightness component

M -by- N matrix

Brightness component, specified as an M -by- N matrix.

Data Types: `single` | `double`

X — X component

M-by-*N* matrix

X component, specified as an *M*-by-*N* matrix.

Data Types: single | double

Y — Y component

M-by-*N* matrix

Y component, specified as an *M*-by-*N* matrix.

Data Types: single | double

Z — Z component

M-by-*N* matrix

Z component, specified as an *M*-by-*N* matrix.

Data Types: single | double

L* — Luminance portion

M-by-*N* matrix

Luminance component, specified as an *M*-by-*N* matrix.

Data Types: single | double

a* — a* component

M-by-*N* matrix

a* component, specified as an *M*-by-*N* matrix.

Data Types: single | double

b* — b* component

M-by-*N* matrix

b* component, specified as an *M*-by-*N* matrix.

Data Types: single | double

Parameters**Conversion — Conversion**

R'G'B' to Y'CbCr (default) | Y'CbCr to R'G'B' | R'G'B' to intensity | R'G'B' to HSV | HSV to R'G'B' | sR'G'B' to XYZ | XYZ to sR'G'B' | sR'G'B' to L*a*b*

Specify the conversion color spaces as one of the following:

- R'G'B' to Y'CbCr
- Y'CbCr to R'G'B'
- R'G'B' to intensity
- R'G'B' to HSV
- HSV to R'G'B'

- sR'G'B' to XYZ
- XYZ to sR'G'B'
- sR'G'B' to L*a*b*
- L*a*b* to sR'G'B'

Use conversion specified by — Conversion standard

Rec. 601 (SDTV) (default) | Rec. 709 (HDTV)

Specify the standard to convert your values between the R'G'B' and Y'CbCr color spaces as either Rec. 601 (SDTV) or Rec. 709 (HDTV).

Dependencies

This parameter is visible when you set the **Conversion** to R'G'B' to Y'CbCr or Y'CbCr to R'G'B'.

Scanning standard — Scanning standard

1125/60/2:1 (default) | 1250/50/2:1

Specify the scanning standard to convert between the R'G'B' and Y'CbCr color spaces as either 1125/60/2:1 or 1250/50/2:1.

Dependencies

This parameter is visible when you set the **Use conversion specified by** parameter to Rec. 709 (HDTV).

White point — White point

D50 (default) | D55 | D65

Specify the reference white point.

Dependencies

This parameter is visible when you set the **Conversion** parameter to sR'G'B' to L*a*b* or L*a*b* to sR'G'B'.

Image signal — Image signal input

One multidimensional signal (default) | Separate color signals

Specify how to input and output a color signal. If you select **One multidimensional signal**, the block accepts an M -by- N -by- P color signal, where P is the number of color planes, at one port. If you select **Separate color signals**, additional ports appear on the block. Each port accepts one M -by- N plane of color signal stream.

Note The prime notation indicates that the signals are gamma corrected.

Block Characteristics

Data Types	Boolean double integer single
Multidimensional Signals	yes

Variable-Size Signals	yes
------------------------------	-----

Algorithms

Conversion Between R'G'B' and Y'CbCr Color Spaces

The following equations define R'G'B' to Y'CbCr conversion and Y'CbCr to R'G'B' conversion:

$$\begin{bmatrix} Y' \\ Cb \\ Cr \end{bmatrix} = \begin{bmatrix} 16 \\ 128 \\ 128 \end{bmatrix} + A \times \begin{bmatrix} R' \\ G' \\ B' \end{bmatrix}$$

$$\begin{bmatrix} R' \\ G' \\ B' \end{bmatrix} = B \times \left(\begin{bmatrix} Y' \\ Cb \\ Cr \end{bmatrix} - \begin{bmatrix} 16 \\ 128 \\ 128 \end{bmatrix} \right)$$

The values in matrices A and B are based on your choices for the **Use conversion specified by** and **Scanning standard** parameters.

Matrix	Use conversion specified by = Rec. 601 (SDTV)	Use conversion specified by = Rec. 709 (HDTV)	
		Scanning standard = 1125/60/2:1	Scanning standard = 1250/50/2:1
A	0.25678824 0.50412941 0.09790588 -0.14822229 -0.29099279 0.43921569 0.43921569 -0.36778831 -0.07142737	0.18258588 0.61423059 0.06200706 -0.10064373 -0.33857195 0.43921569 0.43921569 -0.39894216 -0.04027352	0.25678824 0.50412941 0.09790588 -0.14822229 -0.29099279 0.43921569 0.43921569 -0.36778831 -0.07142737
B	1.1643836 0 1.5960268 1.1643836 -0.39176229 -0.81296765 1.1643836 2.0172321 0	1.16438356 0 1.79274107 1.16438356 -0.21324861 -0.53290933 1.16438356 2.11240179 0	1.1643836 0 1.5960268 1.1643836 -0.39176229 -0.81296765 1.1643836 2.0172321 0

Conversion from R'G'B' to Intensity

The following equation defines conversion from the R'G'B' color space to intensity:

$$\text{intensity} = [0.299 \ 0.587 \ 0.114] \begin{bmatrix} R' \\ G' \\ B' \end{bmatrix}$$

Conversion Between R'G'B' and HSV Color Spaces

The R'G'B' to HSV conversion is defined by the following equations. In these equations, *MAX* and *MIN* represent the maximum and minimum values of each R'G'B' triplet, respectively. *H*, *S*, and *V* vary from 0 to 1, where 1 represents the greatest saturation and value.

$$H = \begin{cases} \left(\frac{G' - B'}{MAX - MIN} \right) / 6, & \text{if } R' = MAX \\ \left(2 + \frac{B' - R'}{MAX - MIN} \right) / 6, & \text{if } G' = MAX \\ \left(4 + \frac{R' - G'}{MAX - MIN} \right) / 6, & \text{if } B' = MAX \end{cases}$$

$$S = \frac{MAX - MIN}{MAX}$$

$$V = MAX$$

The HSV to R'G'B' conversion is defined by the following equations:

$$H_i = [6H]$$

$$f = 6H - H_i$$

$$p = 1 - S$$

$$q = 1 - fS$$

$$t = 1 - (1 - f)S$$

$$\text{if } H_i = 0, R_{tmp} = 1, G_{tmp} = t, B_{tmp} = p$$

$$\text{if } H_i = 1, R_{tmp} = q, G_{tmp} = 1, B_{tmp} = p$$

$$\text{if } H_i = 2, R_{tmp} = p, G_{tmp} = 1, B_{tmp} = t$$

$$\text{if } H_i = 3, R_{tmp} = p, G_{tmp} = q, B_{tmp} = 1$$

$$\text{if } H_i = 4, R_{tmp} = t, G_{tmp} = p, B_{tmp} = 1$$

$$\text{if } H_i = 5, R_{tmp} = 1, G_{tmp} = p, B_{tmp} = q$$

$$u = V / \max(R_{tmp}, G_{tmp}, B_{tmp})$$

$$R' = uR_{tmp}$$

$$G' = uG_{tmp}$$

$$B' = uB_{tmp}$$

Conversion Between sR'G'B' and XYZ Color Spaces

The sR'G'B' to XYZ conversion is a two-step process. First, the block converts the gamma-corrected sR'G'B' values to linear sRGB values using the following equations:

$$\text{If } R'_{sRGB}, G'_{sRGB}, B'_{sRGB} \leq 0.03928$$

$$R_{sRGB} = R'_{sRGB} / 12.92$$

$$G_{sRGB} = G'_{sRGB} / 12.92$$

$$B_{sRGB} = B'_{sRGB} / 12.92$$

$$\text{otherwise, if } R'_{sRGB}, G'_{sRGB}, B'_{sRGB} > 0.03928$$

$$R_{sRGB} = \left[(R'_{sRGB} + 0.055) / 1.055 \right]^{2.4}$$

$$G_{sRGB} = \left[(G'_{sRGB} + 0.055) / 1.055 \right]^{2.4}$$

$$B_{sRGB} = \left[(B'_{sRGB} + 0.055) / 1.055 \right]^{2.4}$$

Then the block converts the sRGB values to XYZ values using the following equation:

$$\begin{bmatrix} X \\ Y \\ Z \end{bmatrix} = \begin{bmatrix} 0.41239079926596 & 0.35758433938388 & 0.18048078840183 \\ 0.21263900587151 & 0.71516867876776 & 0.07219231536073 \\ 0.01933081871559 & 0.11919477979463 & 0.95053215224966 \end{bmatrix} \times \begin{bmatrix} R_{sRGB} \\ G_{sRGB} \\ B_{sRGB} \end{bmatrix}$$

The XYZ to sR'G'B' conversion is also a two-step process. First, the block converts the XYZ values to linear sRGB values using the following equation:

$$\begin{bmatrix} R_{sRGB} \\ G_{sRGB} \\ B_{sRGB} \end{bmatrix} = \begin{bmatrix} 0.41239079926596 & 0.35758433938388 & 0.18048078840183 \\ 0.21263900587151 & 0.71516867876776 & 0.07219231536073 \\ 0.01933081871559 & 0.11919477979463 & 0.95053215224966 \end{bmatrix}^{-1} \times \begin{bmatrix} X \\ Y \\ Z \end{bmatrix}$$

Then the block applies gamma correction to obtain the sR'G'B' values. This process is described by the following equations:

$$\begin{aligned} &\text{If } R_{sRGB}, G_{sRGB}, B_{sRGB} \leq 0.00304 \\ &R'_{sRGB} = 12.92R_{sRGB} \\ &G'_{sRGB} = 12.92G_{sRGB} \\ &B'_{sRGB} = 12.92B_{sRGB} \\ &\text{otherwise, if } R_{sRGB}, G_{sRGB}, B_{sRGB} > 0.00304 \\ &R'_{sRGB} = 1.055R_{sRGB}^{(1.0/2.4)} - 0.055 \\ &G'_{sRGB} = 1.055G_{sRGB}^{(1.0/2.4)} - 0.055 \\ &B'_{sRGB} = 1.055B_{sRGB}^{(1.0/2.4)} - 0.055 \end{aligned}$$

Note Computer Vision Toolbox software uses a D65 white point, which is specified in Recommendation ITU-R BT.709, for this conversion. In contrast, the Image Processing Toolbox conversion is based on ICC profiles, and it uses a D65 to D50 Bradford adaptation transformation to the D50 white point. If you are using these two products and comparing results, you must account for this difference.

Conversion Between sR'G'B' and L*a*b* Color Spaces

The Color Space Conversion block converts sR'G'B' values to L*a*b* values in two steps. First it converts sR'G'B' to XYZ values using the equations described in “Conversion Between sR'G'B' and XYZ Color Spaces” on page 1-135. Then it uses the following equations to transform the XYZ values to L*a*b* values. Here, X_n , Y_n , and Z_n are the tristimulus values of the reference white point you specify using the **White point** parameter:

$$L^* = 116(Y - 16), \text{ for } Y/Y_n > 0.008856$$

$$L^* = 903.3Y/Y_n, \text{ otherwise}$$

$$a^* = 500(f(X/X_n) - f(Y/Y_n))$$

$$b^* = 200(f(Y/Y_n) - f(Z/Z_n)),$$

$$\text{where } f(t) = t^{1/3}, \text{ for } t > 0.008856$$

$$f(t) = 7.787t + 16/166, \text{ otherwise}$$

The block converts L*a*b* values to sR'G'B' values in two steps as well. The block transforms the L*a*b* values to XYZ values using these equations:

For $Y/Y_n > 0.008856$

$$X = X_n(P + a^*/500)^3$$

$$Y = Y_n P^3$$

$$Z = Z_n(P - b^*/200)^3,$$

$$\text{where } P = (L^* + 16)/116$$

References

- [1] Poynton, Charles A. *A Technical Introduction to Digital Video*. New York: John Wiley & Sons, 1996.
- [2] Recommendation ITU-R BT.601-5, Studio Encoding Parameters of Digital Television for Standard 4:3 and Wide Screen 16:9 Aspect Ratios.
- [3] Recommendation ITU-R BT.709-5. Parameter values for the HDTV standards for production and international programme exchange.
- [4] Stokes, Michael, Matthew Anderson, Srinivasan Chandrasekar, and Ricardo Motta, "A Standard Default Color Space for the Internet - sRGB." November 5, 1996.
- [5] Berns, Roy S. *Principles of Color Technology, 3rd ed.* New York: John Wiley & Sons, 2000.

Extended Capabilities

C/C++ Code Generation

Generate C and C++ code using Simulink® Coder™.

Fixed-Point Conversion

Design and simulate fixed-point systems using Fixed-Point Designer™.

See Also

applycform | makecform | rgb2gray | ycbcr2rgb | rgb2ycbcr | hsv2rgb | rgb2hsv | Chroma Resampling

Introduced before R2006a

Compositing

Combine two images or apply mask to image

Library: Computer Vision Toolbox / Text & Graphics



Description

The Compositing block combines two images, overlays one image over another, or highlights selected pixels in an image. When combining two images, the block uses this equation, in which the output image O is a linear combination of the two images I_1 and I_2 :

$$O(i, j) = (1 - X) * I_1(i, j) + X * I_2(i, j).$$

The opacity factor X scales each pixel before combining the images, where $0 \leq X \leq 1$.

When overlaying one image over another image, or highlighting selected pixels in an input image, the block uses a binary mask to specify which pixels to overwrite or highlight.

Note This block supports binary, intensity, and color images.

Ports

Input

Image1 — Input image one

matrix | array

Input image one, specified as an M -by- N matrix or M -by- N -by- P array. If the input is a M -by- N -by- P array, P is the number of color channels in the image.

Data Types: single | double | int8 | int16 | int32 | uint8 | uint16 | uint32 | Boolean | fixed point

Image2 — Input image two

matrix | array

Input image two, specified as an M -by- N matrix or M -by- N -by- P array. If the input is a M -by- N -by- P array, P is the number of color channels in the image.

Dependencies

To enable this port, set the **Operation** parameter to Blend or Binary mask.

Data Types: single | double | int8 | int16 | int32 | uint8 | uint16 | uint32 | Boolean | fixed point

Mask — Binary mask

scalar | matrix

Binary mask, specified as a scalar or matrix. This mask determines which pixels of **Image1** the block overwrites with the pixel values of **Image2** or highlights, depending on the value of the **Operation** parameter.

- **Binary mask** — The block overwrites the pixel values of **Image1**, indicated by the mask, with the corresponding pixel values of **Image2**. You can specify **Mask** as a scalar 0 or 1, which the block uses for all pixels of **Image2**, or as binary matrix of same size as **Image2**.
- **Highlight selected pixels** — The block highlights the pixels of **Image1** indicated by the mask.

Dependencies

To enable this port:

- If overwriting pixel values in one image with pixel values in another image, set the **Operation** parameter to **Binary mask** and the **Mask source** parameter to **Input port**.
- If highlighting selected pixels in an image, set the **Operation** parameter to **Highlight selected pixels**.

Data Types: single | double | Boolean

Factor — Opacity factor

scalar | matrix

Opacity factor, specified as a scalar or matrix. If specified as a scalar, the value is the scale of combination for each pixel of **Image2** with each corresponding pixel of **Image1**. If specified as a matrix, its dimensions must match the dimensions of **Image2**. Each opacity factor must be in the range [0, 1].

Dependencies

To enable this port, set the **Operation** parameter to **Blend** and the **Opacity factor(s) source** parameter to **Input port**.

Data Types: single | double

Location — Location index

vector

Location index, specified as a two-element vector. The first element represents the row and the second represents the column position of the upper-left corner of **Image2**, relative to the upper-left corner of **Image1**. If the location of the upper-left corner of **Image2** is such that any of its pixels would render outside the bounds of **Image1**, the block clips **Image2** at the final row or column or **Image1**, instead.

Note When the **Image1** input has a fixed-point or boolean data type, the **Location** input must have a built-in integer data type.

Dependencies

To enable this port, set the **Location source** parameter to **Input port**.

Data Types: `single` | `double` | `int8` | `int16` | `int32` | `uint8` | `uint16` | `uint32`

Output

Port_1 — Output image

`matrix`

Output image, returned as an M -by- N matrix or M -by- N -by- P array. If the output is an M -by- N -by- P array, P is the number of color channels in the image.

Data Types: `single` | `double` | `int8` | `int16` | `int32` | `uint8` | `uint16` | `uint32` | `Boolean`

Parameters

Main

Operation — Specify operation

`Blend` (default) | `Binary mask` | `Highlight selected pixels`

Select the image operation for the block to perform.

- **Blend** — Linearly combines the pixel values of **Image1** with the pixel values of **Image2**, with the specified opacity factor.
- **Binary mask** — Overwrites the pixel values of **Image1** with the values of **Image2** specified by the binary mask.
- **Highlight selected pixels** — Highlights the pixels of **Image1** indicated by the binary mask. The highlight operation assign the highest intensity or color values to the pixels of **Image1** corresponding to the pixels with logic 1 of the binary mask.

Opacity factor(s) source — Source of opacity factor

`Specify via dialog` (default) | `Input port`

Specify the source of the opacity factor. If you set this parameter to `Input port`, it enables the **Factor** input port.

Dependencies

To enable this parameter, set the **Operation** parameter to `Blend`.

Opacity factor(s) — Opacity factor

`0.75` (default) | `scalar` | `matrix`

Defines the scale of combination for each pixel of **Image2** with each corresponding pixel of **Image1**. When you specify the opacity factor as `matrix`, its dimensions must match the dimensions of **Image2**. If you specify it as a `scalar`, the block uses that value as the opacity factor for all pixels of **Image2**. The opacity factor must be in the range [0, 1].

Dependencies

To enable this parameter, set the **Operation** parameter to `Blend` and the **Opacity factor(s) source** parameter to `Specify via dialog`.

Location source — Source of overlay location

`Specify via dialog` (default) | `Input port`

Select the source of the overlay location. If you set this parameter to `Input port`, it enables the **Location** input port.

Location [x y] — Overlay location index

[1 1] (default) | two-element vector

Specify the row and column position of the upper-left corner of **Image2**, relative to the upper-left corner of **Image1**, as a two-element vector. If the location of the upper-left corner of **Image2** is such that any of its pixels would render outside the bounds of **Image1**, the block clips **Image2** at the final row or column or **Image1**, instead.

Dependencies

To enable this parameter, set the **Location source** parameter to `Specify via dialog`.

Mask source — Source of mask

`Specify via dialog` (default) | `Input port`

Select the source of the binary mask. If you set this parameter to `Input port`, it enables the **Mask** input port.

Dependencies

To enable this parameter, set the **Operation** parameter to `Binary mask`.

Mask — Binary mask

0 (default) | 1 | matrix

Binary mask, specified as a scalar or matrix, defines which pixels of **Image1** the block overwrites with the corresponding pixel values of **Image2** or highlights. You specify 0 or 1, which the block uses for all pixels in **Image2**, or a binary matrix of the same size of as **Image2**.

Dependencies

To enable this parameter, set the **Operation** parameter to `Binary mask` and the **Mask source** parameter to `Specify via dialog`.

Data Types

For details on the fixed-point block parameters, see “Specify Fixed-Point Attributes for Blocks”.

Block Characteristics

Data Types	Boolean double fixed point integer single
Multidimensional Signals	yes
Variable-Size Signals	yes

Extended Capabilities

C/C++ Code Generation

Generate C and C++ code using Simulink® Coder™.

See Also

Insert Text | Draw Markers | Draw Shapes

Introduced before R2006a

Contrast Adjustment

Adjust image contrast by linearly scaling pixel values



Library

Analysis & Enhancement

visionanalysis

Description

The Contrast Adjustment block adjusts the contrast of an image by linearly scaling the pixel values between upper and lower limits. Pixel values that are above or below this range are saturated to the upper or lower limit value, respectively.

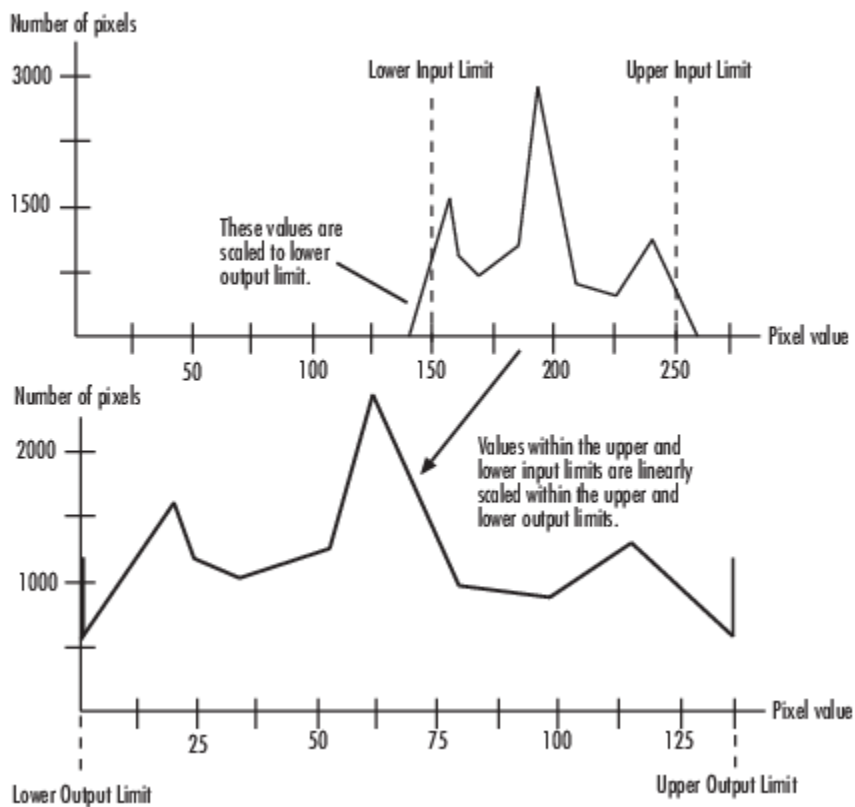

Mathematically, the contrast adjustment operation is described by the following equation, where the input limits are $[low_in\ high_in]$ and the output limits are $[low_out\ high_out]$:

$$Output = \left\{ \begin{array}{l} low_out, Input \leq low_in \\ low_out + (Input - low_in) \frac{high_out - low_out}{high_in - low_in}, low_in < Input < high_in \\ high_out, Input \geq high_in \end{array} \right\}$$

Port	Input/Output	Supported Data Types	Complex Values Supported
I	Vector or matrix of intensity values	<ul style="list-style-type: none"> • Double-precision floating point • Single-precision floating point • Fixed point • 8-, 16-, and 32-bit signed integer • 8-, 16-, and 32-bit unsigned integer 	No
Output	Scalar, vector, or matrix of intensity values or a scalar, vector, or matrix that represents one plane of the RGB video stream	Same as I port	No

Specifying upper and lower limits

Use the **Adjust pixel values from** and **Adjust pixel values to** parameters to specify the upper and lower input and output limits. All options are described below.

Input limits

Use the **Adjust pixel values from** parameter to specify the upper and lower input limits.

If you select **Full input data range [min max]**, uses the minimum input value as the lower input limit and the maximum input value as the upper input limit.

If you select **User-defined**, the **Range [low high]** parameter associated with this option appears. Enter a two-element vector of scalar values, where the first element corresponds to the lower input limit and the second element corresponds to the upper input limit.

If you select **Range determined by saturating outlier pixels**, the **Percentage of pixels to saturate [low high] (in %)**, **Specify number of histogram bins (used to calculate the range when outliers are eliminated)**, and **Number of histogram bins** parameters appear on the block. The block uses these parameter values to calculate the input limits in this three-step process:

- 1 Find the minimum and maximum input values, $[min_in\ max_in]$.
- 2 Scale the pixel values from $[min_in\ max_in]$ to $[0\ num_bins-1]$, where num_bins is the scalar value you specify in the **Number of histogram bins** parameter. This parameter always displays the value used by the block. Then the block calculates the histogram of the scaled input. For additional information about histograms, see the 2-D Histogram block reference page.
- 3 Find the lower input limit such that the percentage of pixels with values smaller than the lower limit is at most the value of the first element of the **Percentage of pixels to saturate [low high] (in %)** parameter. Similarly, find the upper input limit such that the percentage of pixels with values greater than the upper limit is at least the value of the second element of the parameter.

Output limits

Use the **Adjust pixel values to** parameter to specify the upper and lower output limits.

If you select **Full data type range**, the block uses the minimum value of the input data type as the lower output limit and the maximum value of the input data type as the upper out
 If you select **User-defined range**, the **Range [low high]** parameter appears on the block. Enter a two-element vector of scalar values, where the first element corresponds to the lower output limit and the second element corresponds to the upper output limit.

For INF, -INF and NAN Input Values

If any input pixel value is either **INF** or **-INF**, the Contrast Adjustment block will change the pixel value according to how the parameters are set. The following table shows how the block handles these pixel values.

If Adjust pixel values from parameter is set to...	Contrast Adjustment block will:
Full data range [min,max]	Set the entire output image to the lower limit of the Adjust pixel values to parameter setting.
Range determined by saturating outlier pixels	
User defined range	Lower and higher limits of the Adjust pixel values to parameter set to -INF and INF , respectively.

If any input pixel has a **NAN** value, the block maps the pixels with valid numerical values according to the user-specified method. It maps the **NAN** pixels to the lower limit of the **Adjust pixel values to** parameter.

Examples

See “Adjust the Contrast of Intensity Images” in the *Computer Vision Toolbox User's Guide*.

Fixed-Point Data Types

The following diagram shows the data types used in the Contrast Adjustment block for fixed-point signals:

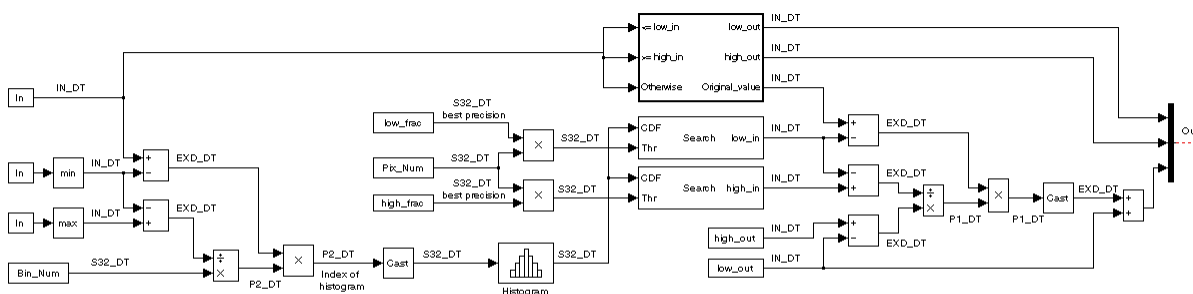

FIXED-POINT TAB NAMES:
 =====
 IN_DT: Datatype of the input image
 EXD_DT: IN_DT with extra bit for sign
 P1_DT: Datatype of product 1
 P2_DT: Datatype of product 2

SUB-SYSTEMS:
 =====
 Search:
 Calculate the pixel value that corresponds to Thr in the cumulative histogram (CDF)

Parameters

Adjust pixel values from

Specify how to enter the upper and lower input limits. Your choices are Full input data range [min max], User-defined, and Range determined by saturating outlier pixels.

Range [low high]

Enter a two-element vector of scalar values. The first element corresponds to the lower input limit, and the second element corresponds to the upper input limit. This parameter is visible if, for the **Adjust pixel values from** parameter, you select User-defined.

Percentage of pixels to saturate [low high] (in %)

Enter a two-element vector. The block calculates the lower input limit such that the percentage of pixels with values smaller than the lower limit is at most the value of the first element. It calculates the upper input limit similarly. This parameter is visible if, for the **Adjust pixel values from** parameter, you select Range determined by saturating outlier pixels.

Specify number of histogram bins (used to calculate the range when outliers are eliminated)

Select this check box to change the number of histogram bins. This parameter is editable if, for the **Adjust pixel values from** parameter, you select Range determined by saturating outlier pixels.

Number of histogram bins

Enter the number of histogram bins to use to calculate the scaled input values. This parameter is available if you select the **Specify number of histogram bins (used to calculate the range when outliers are eliminated)** check box.

Adjust pixel values to

Specify the upper and lower output limits. If you select Full data type range, the block uses the minimum value of the input data type as the lower output limit and the maximum value of the input data type as the upper output limit. If you select User-defined range, the **Range [low high]** parameter appears on the block.

Range [low high]

Enter a two-element vector of scalar values. The first element corresponds to the lower output limit and the second element corresponds to the upper output limit. This parameter is visible if, for the **Adjust pixel values to** parameter, you select User-defined range

Rounding mode

Select the rounding mode for fixed-point operations.

Overflow mode

Select the overflow mode for fixed-point operations.

Product 1

The product output type when the block calculates the ratio between the input data range and the number of histogram bins.



As shown in the previous figure, the output of the multiplier is placed into the product output data type and scaling. Use this parameter to specify how to designate this product output word and fraction lengths:

When you select **Binary point scaling**, you can enter the word length and the fraction length of the product output, in bits.

When you select **Slope and bias scaling**, you can enter the word length, in bits, and the slope of the product output. The bias of all signals in the Computer Vision Toolbox software is 0.

Product 2

The product output type when the block calculates the bin location of each input value.



As shown in the previous figure, the output of the multiplier is placed into the product output data type and scaling. Use this parameter to specify how to designate this product output word and fraction lengths:

When you select **Binary point scaling**, you can enter the word length and the fraction length of the product output, in bits.

When you select **Slope and bias scaling**, you can enter the word length, in bits, and the slope of the product output. The bias of all signals in the Computer Vision Toolbox software is 0.

This parameter is visible if, for the **Adjust pixel values from** parameter, you select **Range determined by saturating outlier pixels**.

Lock data type settings against change by the fixed-point tools

Select this parameter to prevent the fixed-point tools from overriding the data types you specify on the block mask. For more information, see `fxptdlg`, a reference page on the Fixed-Point Tool in the Simulink documentation.

See Also

2D-Histogram	Computer Vision Toolbox software
Histogram Equalization	Computer Vision Toolbox software

Extended Capabilities

C/C++ Code Generation

Generate C and C++ code using Simulink® Coder™.

Introduced in R2006b

Corner Detection

Calculate corner metric matrix and find corners in images

Library: Computer Vision Toolbox / Analysis & Enhancement

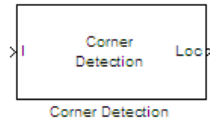

Description

The Corner Detection block finds corners in an image by using the Harris corner detection (by Harris and Stephens), minimum eigenvalue (by Shi and Tomasi), or local intensity comparison (based on the *Accelerated Segment Test*, (FAST) method by Rosten and Drummond) method. The block finds the corners in the image based on the pixels that have the largest corner metric values.

Ports

Input

I — Input image

matrix of intensity values

Input image, specified as a matrix of intensity values.

Data Types: single | double | int8 | int16 | int32 | int64 | uint8 | uint16 | uint32 | uint64 | fixed point

Output

Loc — Corner locations

M -by-2 matrix

Corner locations, returned as an M -by-2 matrix of $[x \ y]$ coordinates. M represents the number of corners and is less than or equal to the **Maximum number of corners** parameter.

Dependencies

To enable this port, set the **Output** parameter to one of these:

- Corner location
- Corner location and metric matrix

Data Types: uint32

Count — Number of detected corners

scalar

Number of detected corners, returned as a scalar.

Dependencies

To enable this port, set these block parameters:

- **Output:** Corner location | Corner location and metric matrix
- **Output variable size signal:** off

Data Types: uint32

Metric — Corner metric values

matrix

Corner metric values, returned as a matrix of intensity values. The returned matrix is the same size as the input image.

Dependencies

To enable this port, set the **Output** parameter to one of these:

- Corner location and metric matrix
- Metric matrix

Data Types: single | double | int8 | int16 | int32 | int64 | uint8 | uint16 | uint32 | uint64 | fixed point

Parameters

Main Tab

Method — Corner detection method

Harris corner detection (Harris & Stephens) (default) | Minimum eigenvalue (Shi & Tomasi) | Local intensity comparison (Rosten & Drummond)

Specify the corner detection method as Harris corner detection (Harris & Stephens), Minimum eigenvalue (Shi & Tomasi), or Local intensity comparison (Rosten & Drummond).

To get the most accurate results, use Minimum eigenvalue (Shi & Tomasi). For the fastest computation, use Local intensity comparison (Rosten & Drummond). For a balance between accuracy and computation speed, use Harris corner detection (Harris & Stephens). For more information on each method, see the “Algorithms” on page 1-151 section.

Sensitivity factor (0<k<0.25) — Sensitivity factor

0.04 (default) | scalar

Specify the sensitivity factor, k . As k decreases, the likelihood that the algorithm can detect sharp corners increases.

Tunable: Yes

Dependencies

To enable this parameter, set the **Method** parameter to Harris corner detection (Harris & Stephens).

Coefficients for separable smoothing filter — Filter coefficients

fspecial('gaussian', [1 5], 1.5) (default) | vector

Specify a vector of filter coefficients for the smoothing filter.

Dependencies

To enable this parameter, set the **Method** parameter to one of these:

- Harris corner detection (Harris & Stephens)
- Minimum eigenvalue (Shi & Tomasi)

Intensity comparison threshold — Intensity threshold

0.1 (default) | scalar

Specify the intensity threshold value used to find valid surrounding pixels.

Tunable: Yes

Dependencies

To enable this parameter, set the **Method** parameter to Local intensity comparison (Rosten & Drummond).

Maximum angle to be considered a corner (in degrees) — Maximum corner angle

157.5 (default) | scalar

Specify the maximum corner angle.

Tunable: Yes

Dependencies

- To enable this parameter, set the **Method** parameter to Local intensity comparison (Rosten & Drummond).
- This parameter is tunable for simulation only.

Output — Block output

Corner location (default) | Corner location and metric matrix | Metric matrix

Specify the block output as Corner location, Corner location and metric matrix, and Metric matrix.

Set this parameter to Corner location or Corner location and metric matrix to expose the **Maximum number of corners**, **Minimum metric value that indicates a corner**, and **Neighborhood size (suppress region around detected corners)** parameters.

Maximum number of corners — Maximum number of corners

200 (default) | integer

Specify the maximum number of corners you want the block to find.

Dependencies

To enable this parameter, set the **Output** parameter to one of these:

- Corner location
- Corner location and metric matrix

Minimum metric value that indicates a corner — Minimum corner metric

0.0005 (default) | scalar

Specify the minimum corner metric value.

Tunable: Yes

Dependencies

To enable this parameter, set the **Output** parameter to one of these:

- Corner location
- Corner location and metric matrix

Neighborhood size — Neighborhood size

[11 11] (default) | 2-element vector

Specify the neighborhood size as a two-element vector of positive odd integers, [*row*, *column*]. The block uses this parameter to suppress the region around a valid corner point with the largest corner metric value.

Dependencies

To enable this parameter, set the **Output** parameter to one of these:

- Corner location
- Corner location and metric matrix

Output variable size signal — Variable size signal

on (default) | off

Select this parameter to output a variable size signal.

Dependencies

To enable this parameter, set the **Output** parameter to one of these:

- Corner location
- Corner location and metric matrix

Data Types Tab

For details on the fixed-point block parameters, see “Specify Fixed-Point Attributes for Blocks”.

Block Characteristics

Data Types	Boolean ^a double fixed point integer single
Multidimensional Signals	no
Variable-Size Signals	yes

a. This data type is not supported for the Local Intensity Comparison method.

Algorithms

Determine final corner values

To determine the final corner values, the block follows this process:

- 1 Find the pixel with the largest corner metric value.
- 2 Verify that the metric value is greater than or equal to the value you specified for the **Minimum metric value that indicates a corner** parameter.
- 3 Suppress the region around the corner value by the size defined in the **Neighborhood size (suppress region around detected corners)** parameter.

The block repeats this process until it finds all the corners in the image or it finds the number of corners you specified in the **Maximum number of corners** parameter.

The corner metric values computed by the `Minimum eigenvalue` and `Local intensity comparison` methods are always nonnegative. The corner metric values computed by the `Harris corner detection` method can be negative.

Minimum Eigenvalue Method

The method is more computationally expensive than the Harris corner detection algorithm because it directly calculates the eigenvalues of the sum of the squared difference matrix, M .

The sum of the squared difference matrix, M , is defined as follows:

$$M = \begin{bmatrix} A & C \\ C & B \end{bmatrix}$$

The previous equation is based on the following values:

$$A = (I_x)^2 \otimes w$$

$$B = (I_y)^2 \otimes w$$

$$C = (I_x I_y)^2 \otimes w$$

where I_x and I_y are the gradients of the input image, I , in the x and y direction. The \otimes symbol denotes a convolution operation.

Use the **Coefficients for separable smoothing filter** parameter to define a vector of filter coefficients. The block multiplies this vector of coefficients by its transpose to create a matrix of filter coefficients, w .

The block calculates the smaller eigenvalue of the sum of the squared difference matrix. This minimum eigenvalue corresponds to the corner metric matrix.

Harris Corner Method

The Harris corner detection method avoids the explicit computation of the eigenvalues of the sum of squared differences matrix by solving for the corner metric matrix, R :

$$R = AB - C^2 - k(A + B)^2$$

See the Minimum Eigenvalue Method section for the definitions of A , B , and C .

The variable k corresponds to the sensitivity factor. You can specify its value using the **Sensitivity factor (0 < k < 0.25)** parameter. As k decreases, the likelihood that the algorithm can detect sharp corners increases.

Use the **Coefficients for separable smoothing filter** parameter to define a vector of filter coefficients. The block multiplies this vector of coefficients by its transpose to create a matrix of filter coefficients, w .

Local Intensity Method

The method determines that a pixel is a possible corner if it has either, N contiguous valid bright surrounding pixels, or N contiguous dark surrounding pixels.

Suppose that p is the pixel under consideration and j is one of the pixels surrounding p . The locations of the other surrounding pixels are denoted by the shaded areas in the following figure. The shaded areas in this figure denote the locations of other surrounding pixels.

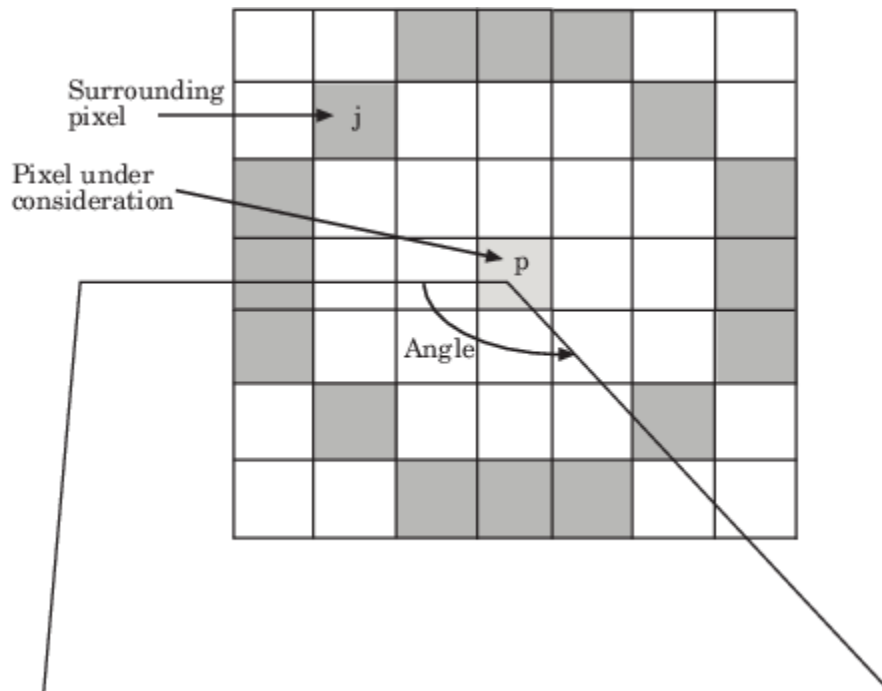

I_p and I_j are the intensities of pixels p and j , respectively. Pixel j is a valid bright surrounding pixel if $I_j - I_p \geq T$. Similarly, pixel j is a valid dark surrounding pixel if $I_p - I_j \geq T$. In these equations, T is the value you specified for the **Intensity comparison threshold** parameter.

The block repeats this process to determine whether the block has N contiguous valid surrounding pixels. The value of N is related to the value you specify for the **Maximum angle to be considered a corner (in degrees)** parameter, as shown in this table.

Number of Valid Surrounding Pixels and Angle

Number of Valid Surrounding Pixels	Angle (degrees)
15	22.5
14	45
13	67.5
12	90
11	112.5
10	135
9	157.5

After the block determines that a pixel is a possible corner, it computes its corner metric using the following equation:

$$R = \max \left(\sum_{j: I_j \geq I_p + T} |I_p - I_j| - T, \sum_{j: I_j \leq I_p - T} |I_p - I_j| - T \right)$$

References

- [1] Harris, C. and M Stephens. "A Combined Corner and Edge Detector." *Proceedings of the 4th Alvey Vision Conference*, 147-151. August 1988.
- [2] Shi, J. and C. Tomasi. "Good Features to Track." *Proceedings of the IEEE Conference on Computer Vision and Pattern Recognition*, 593-600. June 1994.
- [3] Rosten, E. and T. Drummond. "Fusing Points and Lines for High Performance Tracking." *Proceedings of the IEEE International Conference on Computer Vision Vol. 2*, 1508-1511. October 2005.

Extended Capabilities

C/C++ Code Generation

Generate C and C++ code using Simulink® Coder™.

Fixed-Point Conversion

Design and simulate fixed-point systems using Fixed-Point Designer™.

These diagrams show the data types used in the Corner Detection block for fixed-point signals. These diagrams apply to the Harris corner detection and minimum eigenvalue methods only.

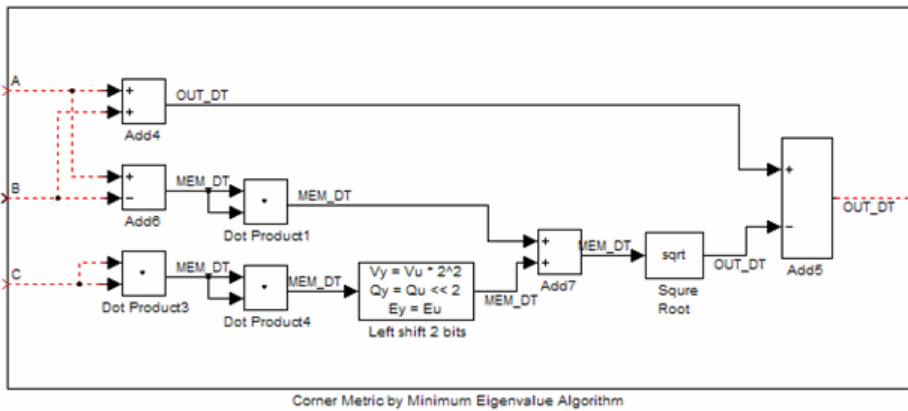
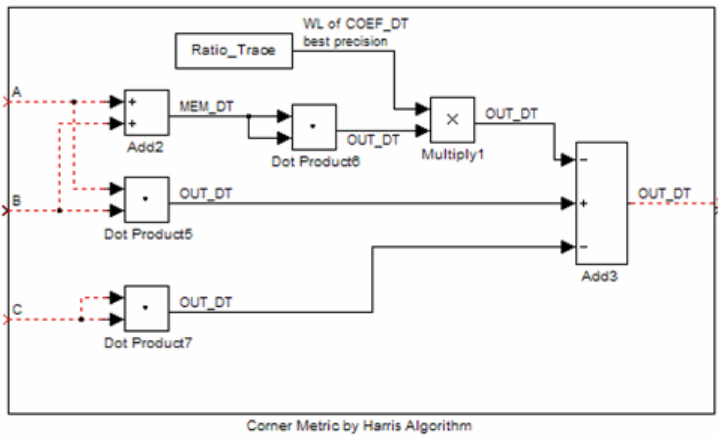
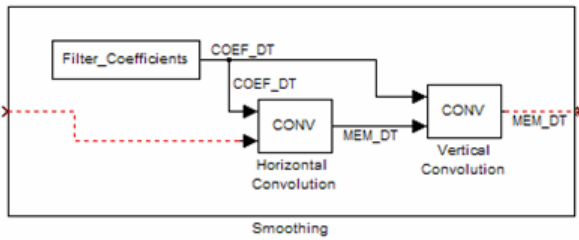
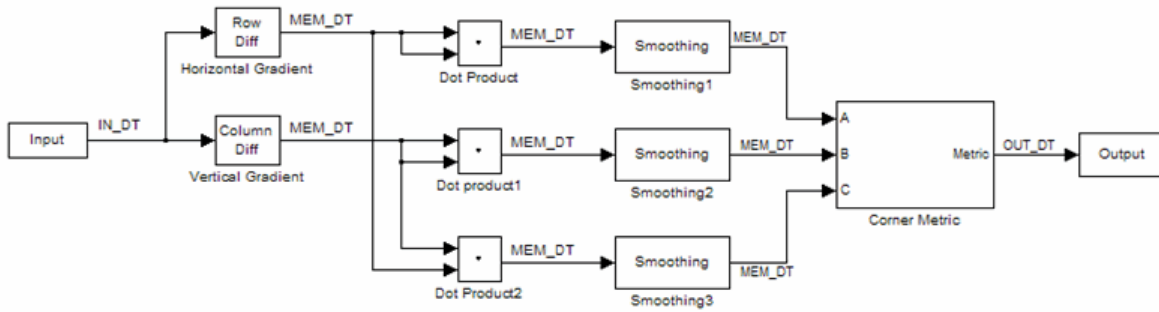

The following table summarizes the variables used in the previous diagrams.

Variable Name	Definition
IN_DT	Input data type
MEM_DT	Memory data type
OUT_DT	Metric output data type
COEF_DT	Coefficients data type

See Also

Blocks

Find Local Maxima | Estimate Geometric Transformation | Warp

Functions

matchFeatures | extractFeatures | detectSURFFeatures | detectHarrisFeatures | detectFASTFeatures | detectORBFeatures | estimateGeometricTransform2D

Introduced in R2007b

Deinterlacing

Remove interlacing effect

Library: Computer Vision Toolbox / Analysis & Enhancement



Description

The `Deinterlacing` block removes the motion artifact known as the interlacing effect from an interlaced image or a video. An interlaced image or video frame comprises of top field and bottom field that has slightly different capture times. The odd numbered lines in an interlaced image constitute the top field and the even numbered lines constitute the bottom field.

When you display an interlaced image, the temporal difference between the top and bottom fields causes a visible artifact where the alternate lines in the interlaced image appear displaced.

This artifact is known as the interlacing effect and can be corrected through deinterlacing techniques. You can use the `Deinterlacing` block to convert an interlaced video into a deinterlaced video by using one of these methods:

- Line repetition
- Linear interpolation
- Vertical temporal median filtering

You can use this block to deinterlace both intensity and color images.

Ports

Input

Port_1 — Interlaced input

numeric matrix | 3-D numeric array | image | video

Interlaced input, specified as a numeric matrix, 3-D numeric array, image, or video.

To input an interlaced image, read the image file by using the `Image From File` or `Image From Workspace` block. The image can also be a video frame. To input an interlaced video, read the video file by using the `From Multimedia File` or `Video From Workspace` block.

Data Types: `single` | `double` | `int8` | `int16` | `int32` | `int64` | `uint8` | `uint16` | `uint32` | `uint64` | `fixed point`

Output

Port_1 — Deinterlaced output

numeric matrix | 3-D numeric array | image | video

Deinterlaced output, returned as a numeric matrix, 3-D numeric array, image, or video. The output is of same size and datatype as that of the input.

Data Types: `single` | `double` | `int8` | `int16` | `int32` | `int64` | `uint8` | `uint16` | `uint32` | `uint64` | `fixed point`

Parameters

Main Tab

Method — Deinterlacing method

`Line repetition (default)` | `Linear interpolation` | `Vertical temporal median filtering`

Use this parameter to specify the method for deinterlacing the input data.

- If you set the **Method** parameter value to `Line repetition`, the values in the bottom field of the interlaced image or video frame are replaced with the values in the preceding top field.

Line Repetition

Original Interlaced Video

Top Field			Bottom Field		
Row 1	A	B	C	Row 1	
Row 2				Row 2	D E F
Row 3	G	H	I	Row 3	
Row 4				Row 4	J K L
Row 5	M	N	O	Row 5	
Row 6				Row 6	P Q R

Block Input

Block Output - Deinterlaced Video

Row 1	A	B	C	Row 1	A	B	C
Row 2	D	E	F	Row 2	A	B	C
Row 3	G	H	I	Row 3	G	H	I
Row 4	J	K	L	Row 4	G	H	I
Row 5	M	N	O	Row 5	M	N	O
Row 6	P	Q	R	Row 6	M	N	O

- If you set the **Method** parameter value to `Line interpolation`, the values in a bottom field are computed as the average of the values in the two neighboring top fields.

Linear Interpolation

Original Interlaced Video

Top Field			Bottom Field				
Row 1	A	B	C	Row 1			
Row 2				Row 2	D	E	F
Row 3	G	H	I	Row 3			
Row 4				Row 4	J	K	L
Row 5	M	N	O	Row 5			
Row 6				Row 6	P	Q	R

Block Input

Block Output - Deinterlaced Video

Row 1	A	B	C	Row 1	A	B	C
Row 2	D	E	F	Row 2	$(A+G)/2$	$(B+H)/2$	$(C+I)/2$
Row 3	G	H	I	Row 3	G	H	I
Row 4	J	K	L	Row 4	$(G+M)/2$	$(H+N)/2$	$(I+O)/2$
Row 5	M	N	O	Row 5	M	N	O
Row 6	P	Q	R	Row 6	M	N	O

- If you set the **Method** parameter value to `Vertical temporal median filtering`, the values in a bottom field are computed as the median of the values in the bottom field and its two neighboring top fields.

Vertical Temporal Median Filtering

Original Interlaced Video

Top Field			Bottom Field		
Row 1	A	B	C	Row 1	
Row 2				Row 2	D E F
Row 3	G	H	I	Row 3	
Row 4				Row 4	J K L
Row 5	M	N	O	Row 5	
Row 6				Row 6	P Q R

Block Input

Block Output - Deinterlaced Video

Row 1	A	B	C	Row 1	A	B	C
Row 2	D	E	F	Row 2	median([A,D,G])	median([B,E,H])	median([C,F,I])
Row 3	G	H	I	Row 3	G	H	I
Row 4	J	K	L	Row 4	median([G,J,M])	median([H,K,N])	median([I,L,O])
Row 5	M	N	O	Row 5	M	N	O
Row 6	P	Q	R	Row 6	M	N	O

Input image is transposed (data order is row major) – Specify data order
 off (default) | on

You can use this parameter to specify if the interlaced input is stored in row major order. When you select this parameter, the block assumes that the input buffer contains contiguous data elements of an array that are arranged sequentially row by row. Otherwise, the blocks assumes that the buffer stores data in the column major order such that the elements are arranged sequentially column by column.

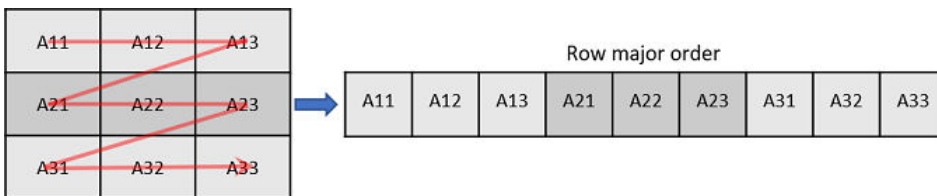

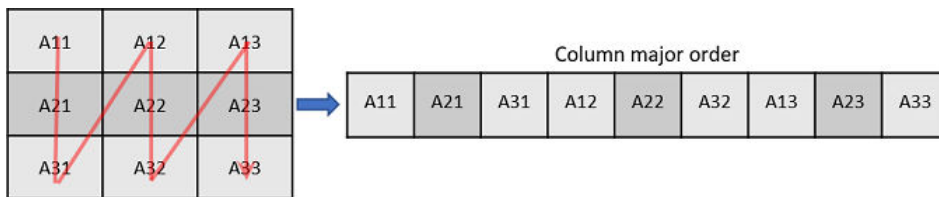

Use this parameter only when

- You are developing algorithms to run on an embedded target that uses the row-major format.
- You want to limit the additional processing required to take the transpose of signals at the interfaces of the row-major and column-major systems.

When you select this check box, the first two dimensions of the Deinterlacing block's input are swapped.

Data Types Tab

To enable options on the **Data Types** tab, set the **Method** parameter in the **Main** tab to Linear interpolation.

Fixed-point operational parameters

Rounding mode — Rounding mode for calculating fixed-point value

Floor (default) | Ceiling | Convergent | Nearest | Round | Simplest | Zero

Specifies the rounding mode for the block to use when the specified data type and scaling cannot exactly represent the result of a fixed-point calculation.

See “Rounding Modes” for more information on the available options.

Saturate on integer overflow — Specify overflow mode

on (default) | off

When you select this parameter, the block saturates the result of its fixed-point operation. When you clear this parameter, the block wraps the result of its fixed-point operation.

For details on saturate and wrap, see “Overflow Handling” for fixed-point operations.

Fixed-point data types

Accumulator — Accumulator data type

Binary point scaling (default) | Same as input

Use this parameter to specify the data type and scaling of the accumulator (sum).

- When you select `Binary point scaling`, you can enter the word length and the fraction length of the accumulator, in bits. The default value for word length is set to 12 and fraction length is set to 3. The data type format is same as that of the input data format, signed or unsigned.
- When you select `Same as input`, the word length and the fractional length of the accumulator match those of the input.

Output — Data type for output

Same as input (default) | Binary point scaling

Use this parameter to specify the data type and scaling of the output data.

- When you select `Same as input`, the word length and the fractional length of the accumulator match those of the input.
- When you select `Binary point scaling`, you can enter the word length and the fraction length of the output, in bits. The default value for word length is set to 8 and fraction length is set to 0. The data type format is same as that of the input data type format, signed or unsigned.

Lock data type settings against change by the fixed-point tools – Data type override

off (default) | on

Select this parameter to prevent the fixed-point tools from overriding the data types you specify on the block mask. For more information, see `fxptdlg`, a reference page on the Fixed-Point Tool.

Block Characteristics

Data Types	double fixed point integer single
Multidimensional Signals	yes
Variable-Size Signals	yes

Extended Capabilities

C/C++ Code Generation

Generate C and C++ code using Simulink® Coder™.

See Also

`vision.Deinterlacer`

Introduced before R2006a

Demosaic

Demosaic Bayer's format images

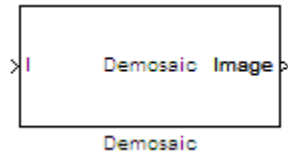

Library

Conversions

visionconversions

Description

The following figure illustrates a 4-by-4 image in Bayer's format with each pixel labeled R, G, or B.

B	G	B	G
G	R	G	R
B	G	B	G
G	R	G	R

The Demosaic block takes in images in Bayer's format and outputs RGB images. The block performs this operation using a gradient-corrected linear interpolation algorithm or a bilinear interpolation algorithm.

Port	Input/Output	Supported Data Types	Complex Values Supported
I	Matrix of intensity values <ul style="list-style-type: none"> If, for the Interpolation algorithm parameter, you select <code>Bilinear</code>, the number of rows and columns must be greater than or equal to 3. If, for the Interpolation algorithm parameter, you select <code>Gradient-corrected linear</code>, the number of rows and columns must be greater than or equal to 5. 	<ul style="list-style-type: none"> Double-precision floating point Single-precision floating point Fixed point 8-, 16-, and 32-bit signed integer 8-, 16-, and 32-bit unsigned integer 	No
R, G, B	Matrix that represents one plane of the input RGB video stream. Outputs from the R, G, or B ports have the same data type.	Same as I port	No
Image	M-by-N matrix of intensity values or an M-by-N-by-P color video signal where P is the number of color planes.	Same as I port	No

Use the **Interpolation algorithm** parameter to specify the algorithm the block uses to calculate the missing color information. If you select `Bilinear`, the block spatially averages neighboring pixels to calculate the color information. If you select `Gradient-corrected linear`, the block uses a Weiner approach to minimize the mean-squared error in the interpolation. This method performs well on the edges of objects in the image. For more information, see [1].

Use the **Sensor alignment** parameter to specify the alignment of the input image. Select the sequence of R, G and B pixels that correspond to the 2-by-2 block of pixels in the top-left corner of the image. You specify the sequence in left-to-right, top-to-bottom order. For example, for the image at the beginning of this reference page, you would select `BGGR`.

Both methods use symmetric padding at the image boundaries. For more information, see the Image Pad block reference page.

Use the **Output image signal** parameter to specify how to output a color video signal. If you select `One multidimensional signal`, the block outputs an M-by-N-by-P color video signal, where P is the number of color planes, at one port. If you select `Separate color signals`, additional ports appear on the block. Each port outputs one M-by-N plane of an RGB video stream.

Fixed-Point Data Types

The following diagram shows the data types used in the Demosaic block for fixed-point signals.

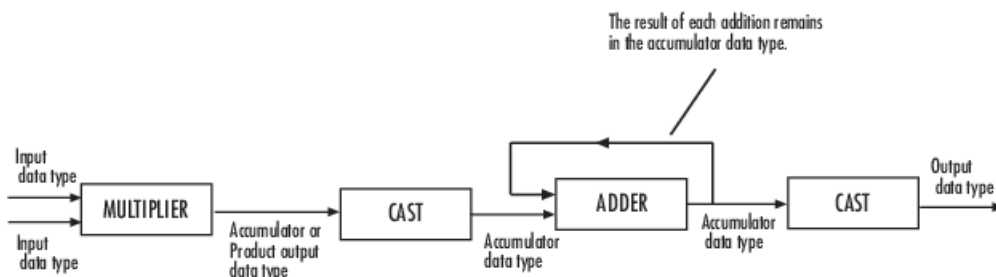

You can set the product output and accumulator data types in the block mask as discussed in the next section.

Parameters

Interpolation algorithm

Specify the algorithm the block uses to calculate the missing color information. Your choices are `Bilinear` or `Gradient-corrected linear`.

Sensor alignment

Select the sequence of R, G and B pixels that correspond to the 2-by-2 block of pixels in the top left corner of the image. You specify the sequence in left-to-right, top-to-bottom order.

Output image signal

Specify how to output a color video signal. If you select `One multidimensional signal`, the block outputs an M-by-N-by-P color video signal, where P is the number of color planes, at one port. If you select `Separate color signals`, additional ports appear on the block. Each port outputs one M-by-N plane of an RGB video stream.

Rounding mode

Select the rounding mode for fixed-point operations.

Overflow mode

Select the overflow mode for fixed-point operations.

Product output



As depicted in the previous figure, the output of the multiplier is placed into the product output data type and scaling. Use this parameter to specify how to designate this product output word and fraction lengths:

When you select `Same as input`, these characteristics match those of the input to the block.

When you select `Binary point scaling`, you can enter the word length and the fraction length of the product output, in bits.

When you select `Slope and bias scaling`, you can enter the word length, in bits, and the slope of the product output. The bias of all signals in the Computer Vision Toolbox blocks is 0.

Accumulator

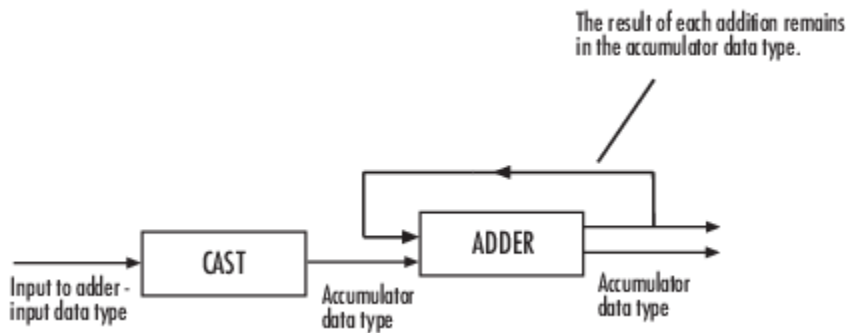

As depicted in the previous figure, inputs to the accumulator are cast to the accumulator data type. The output of the adder remains in the accumulator data type as each element of the input is added to it. Use this parameter to specify how to designate this accumulator word and fraction lengths:

- When you select `Same as product output`, these characteristics match those of the product output.
- When you select `Same as input`, these characteristics match those of the input.
- When you select `Binary point scaling`, you can enter the word length and the fraction length of the accumulator, in bits.
- When you select `Slope and bias scaling`, you can enter the word length, in bits, and the slope of the accumulator. The bias of all signals in the Computer Vision Toolbox blocks is 0.

Lock data type settings against change by the fixed-point tools

Select this parameter to prevent the fixed-point tools from overriding the data types you specify on the block mask. For more information, see `fxptdlg`, a reference page on the Fixed-Point Tool in the Simulink documentation.

References

- [1] Malvar, Henrique S., Li-wei He, and Ross Cutler. "High-Quality Linear Interpolation for Demosaicing of Bayer-Patterned Color Images." *Microsoft Research*, May 2004. http://research.microsoft.com/pubs/102068/Demosaicing_ICASSP04.pdf.
- [2] Gunturk, Bahadir K., John Glotzbach, Yucel Altunbasak, Ronald W. Schafer, and Russel M. Mersereau, "Demosaicking: Color Filter Array Interpolation," *IEEE Signal Processing Magazine*, Vol. 22, Number 1, January 2005.

Extended Capabilities

C/C++ Code Generation

Generate C and C++ code using Simulink® Coder™.

Introduced in R2006b

Dilation

Dilate binary or intensity images by finding local maxima

Library: Computer Vision Toolbox / Morphological Operations



Description

The Dilation block performs morphological dilation on an intensity or binary image and outputs the dilated image.

To define the structuring element that the block applies to the image, use the **Neighborhood or structuring element** parameter. Specify this element by entering a vector or matrix of 1s and 0s or by using the `strel` function.

The Dilation block rotates the structuring element about its origin (if it is unsymmetrical), and places this origin over each pixel of the image object. The block creates the output matrix, that is, the dilated image, from the local maxima values found at each pixel.

Original

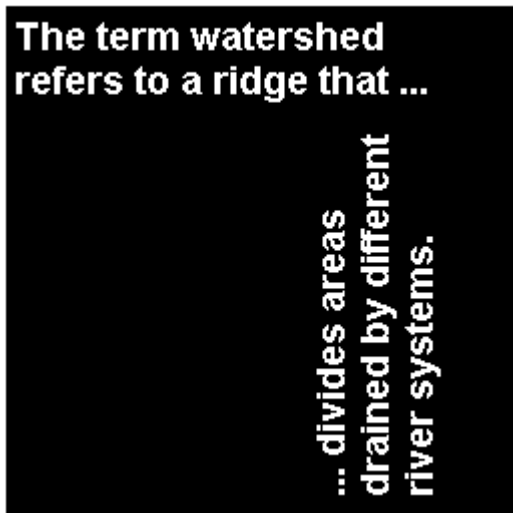

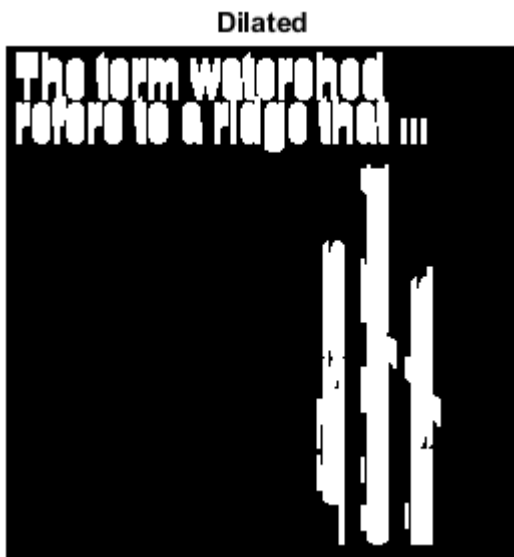

This block uses two-dimensional flat structuring elements only.

Ports

Input

I — Input image

matrix

Specify an input image as a matrix of intensity values. This port is unnamed unless you set the **Neighborhood or structuring element source** parameter to `Input port`.

Data Types: `single` | `double` | `int8` | `int16` | `int32` | `uint8` | `uint16` | `uint32` | `Boolean` | `fixed point`

Nhood — Neighborhood values

vector | matrix

Specify neighborhood values representing a structuring element as a vector or matrix of 1s and 0s or by using the `strel` function.

Dependencies

To enable this port, set the **Neighborhood or structuring element source** parameter to `Input port`.

Data Types: `Boolean`

Output

Port_1 — Dilated image

matrix

The dilated image is returned as a matrix of intensity values. The size and datatype of the output image are the same as those of the input image.

Data Types: `single` | `double` | `int8` | `int16` | `int32` | `uint8` | `uint16` | `uint32` | `Boolean` | `fixed point`

Parameters

Neighborhood or structuring element source — Source of neighborhood or structuring element

Specify via dialog (default) | Input port

Specify the source of neighborhood or structuring element as one of these options:

- **Specify via dialog** — Use the **Neighborhood or structuring element** parameter to specify a neighborhood or structuring element.
- **Input port** — Use the **Nhood** input port to specify neighborhood values representing a structuring element.

Neighborhood or structuring element — Neighborhood or structuring element

[1 1; 1 1] (default) | vector | matrix

Specify neighborhood or structuring element as a vector or matrix of 1s and 0s, a `strel` object or an array of `strel` objects. When you specify an array of `strel` objects, the block applies each object to the entire image in turn.

If the structuring element is decomposable into smaller elements, the block executes at higher speed due to the use of a more efficient algorithm.

Dependencies

To enable this parameter, set the **Neighborhood or structuring element source** parameter, to `Specify via dialog`.

Block Characteristics

Data Types	Boolean double fixed point integer single
Multidimensional Signals	no
Variable-Size Signals	yes

More About

Dilation and Structuring Element

Performing dilation on an image includes,

- Increasing the size of the object by expanding the image pixels and adding pixels to the object's boundaries
- Filling small holes and broken areas and
- Connecting the areas that are separated by a space smaller than the structuring element

The specific way and extent of the object's growth in an image is dependent on the shape of the structuring element. Each structuring element has an origin. If the element is symmetrical, the origin

coincides with its centroid and if it is unsymmetrical, the origin is taken as that pixel, which is slightly towards the top left corner.

Binary Dilation

The *binary dilation* of A by B , denoted $A \oplus B$, is defined as the set operation:

$$A \oplus B = \{z \mid (\widehat{B})_z \cap A \neq \emptyset\},$$

where \widehat{B} is the reflection of the structuring element B . In other words, it is the set of pixel locations z , where the reflected structuring element overlaps with foreground pixels in A when translated to z . Note that some applications use a definition of dilation in which the structuring element is not reflected.

Grayscale Dilation

In the general form of *grayscale dilation*, the structuring element has a height. The grayscale dilation of $A(x, y)$ by $B(x, y)$ is defined as:

$$(A \oplus B)(x, y) = \max\{A(x - x', y - y') + B(x', y') \mid (x', y') \in D_B\},$$

where D_B is the domain of the structuring element B and $A(x, y)$ is assumed to be $-\infty$ outside the domain of the image. To create a structuring element with nonzero height values, use the syntax `strel(nhood, height)`, where `height` gives the height values and `nhood` corresponds to the structuring element domain, D_B .

Most commonly, grayscale dilation is performed with a flat structuring element ($B(x, y) = 0$). Grayscale dilation using such a structuring element is equivalent to a local-maximum operator:

$$(A \oplus B)(x, y) = \max\{A(x - x', y - y') \mid (x', y') \in D_B\}.$$

All of the `strel` syntaxes except for `strel(nhood, height)`, `strel('arbitrary', nhood, height)`, and `strel('ball', ...)` produce flat structuring elements.

References

- [1] Soille, Pierre. *Morphological Image Analysis*. Berlin, Heidelberg: Springer Berlin Heidelberg, 2004. <https://doi.org/10.1007/978-3-662-05088-0>.
- [2] Gonzalez, Rafael C., Richard E. Woods, and Steven L. Eddins. *Digital Image Processing Using MATLAB*. Third edition. Knoxville: Gatesmark Publishing, 2020.

Extended Capabilities

C/C++ Code Generation

Generate C and C++ code using Simulink® Coder™.

See Also

Blocks

Erosion | Opening | Closing | Label | Bottom-hat | Top-hat

Functions

imerode | imdilate | imopen | imclose

Objects

strel

Introduced before R2006a

Draw Markers

Draw markers on image

Library: Computer Vision Toolbox / Text & Graphics

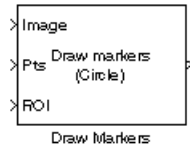

Description

The Draw Markers block draws markers on an image or video frame by overwriting pixel values in the input image. This embeds the markers in the output image. The block supports five types of markers: Circle, X-mark, Plus, Star, and Square.

The block uses Bresenham's circle drawing algorithm to draw circles and Bresenham's line drawing algorithm to draw all other markers.

Ports

Input

Image — Input Image

matrix | array

Specify the input image as either an M -by- N matrix of intensity values or an M -by- N -by- P array of color values with P color planes.

Dependencies

To enable this port, set the **Image signal** parameter to One multidimensional signal.

Data Types: single | double | int8 | int16 | int32 | uint8 | uint16 | uint32 | Boolean | fixed point

R — Red color component of image

matrix

Specify the red color component of the input RGB image as an M -by- N matrix. The **R**, **G**, and **B** ports must have the same dimensions and data type.

Dependencies

To enable this port, set the **Image signal** parameter to Separate color signals.

Data Types: single | double | int8 | int16 | int32 | uint8 | uint16 | uint32 | Boolean | fixed point

G — Green color component of image

matrix

Specify the green color component of the input RGB image as an M -by- N matrix. The **R**, **G**, and **B** ports must have the same dimensions and data type.

Dependencies

To enable this port, set the **Image signal** parameter to `Separate color signals`.

Data Types: `single` | `double` | `int8` | `int16` | `int32` | `uint8` | `uint16` | `uint32` | `Boolean` | `fixed point`

B — Blue color component of image

matrix

Specify the blue color component of the input RGB image as an M -by- N matrix. The **R**, **G**, and **B** ports must have the same dimensions and data type.

Dependencies

To enable this port, set the **Image signal** parameter to `Separate color signals`.

Data Types: `single` | `double` | `int8` | `int16` | `int32` | `uint8` | `uint16` | `uint32` | `Boolean` | `fixed point`

Pts — Marker coordinates

vector | matrix

Specify the coordinates of markers as one of these options:

- Single marker — Two-element vector that specifies the x - and y - coordinates for the center of the marker.
- Multiple markers — K -by-2 matrix. K is the number of markers. Each row of the matrix specifies the x - and y - coordinates for the center of a marker.

Note The block does not support single-precision or double-precision floating-point data types for this parameter unless the input image is also floating point.

Data Types: `single` | `double` | `int8` | `int16` | `int32` | `uint8` | `uint16` | `uint32`

Clr — Marker color

scalar | vector | matrix

Specify the color values for the markers. Use this table to determine the type of value to input at this port.

Type of Input Image	Same Color for All Markers	Different Color for Each Marker
Intensity image	scalar value	K -element vector. K is the number of markers.
Color image	P -element vector. P is the number of color planes.	K -by- P matrix. P is the number of color planes and K is the number of markers.

Dependencies

To enable this port, use one of these options:

- The **Marker shape** parameter is set to X-mark, Plus, or Star, or the **Filled** parameter is cleared — Set the **Border color source** parameter to Input port.
- The **Marker shape** parameter is set to Circle or Square and the **Filled** parameter is selected — Set the **Fill color source** parameter to Input port.

Data Types: single | double | int8 | int16 | int32 | uint8 | uint16 | uint32 | Boolean | fixed point

ROI — Region of interest

vector

Specify a rectangular region of interest (ROI) as a four-element vector of form [x y width height]. The x and y elements are the coordinates of the top-left corner of the ROI.

Dependencies

To enable this port, set the **Draw markers in** parameter to Specify region of interest via port.

Data Types: single | double | int8 | int16 | int32 | uint8 | uint16 | uint32

Output

Port_1 — Output image

matrix | array

Output image, returned as an M -by- N matrix of intensity values or an M -by- N -by- P array of color values. P is the number of color planes in the output image. The output image has the same size and data type as the input image.

Dependencies

To enable this port, set the **Image signal** parameter to One multidimensional signal.

Data Types: single | double | int8 | int16 | int32 | uint8 | uint16 | uint32 | Boolean | fixed point

R — Red color component of output image

matrix

Red color component of the output RGB image, returned as an M -by- N matrix. The red color component of the output image has the same dimensions and data type as the red color component of the input image.

Dependencies

To enable this port, set the **Image signal** parameter to Separate color signals.

Data Types: single | double | int8 | int16 | int32 | uint8 | uint16 | uint32 | Boolean | fixed point

G — Green color component of output image

matrix

Green color component of the output RGB image, returned as an M -by- N matrix. The green color component of the output image has the same dimensions and data type as the green color component of the input image.

Dependencies

To enable this port, set the **Image signal** parameter to `Separate color signals`.

Data Types: `single` | `double` | `int8` | `int16` | `int32` | `uint8` | `uint16` | `uint32` | `Boolean` | `fixed point`

B — Blue color component of output image

`matrix`

Blue color component of the output RGB image, returned as an M -by- N matrix. The blue color component of the output image has the same dimensions and data type as the blue color component of the input image.

Dependencies

To enable this port, set the **Image signal** parameter to `Separate color signals`.

Data Types: `single` | `double` | `int8` | `int16` | `int32` | `uint8` | `uint16` | `uint32` | `Boolean` | `fixed point`

Parameters**Main****Marker shape — Shape of marker**

`Circle` (default) | `X-mark` | `Plus` | `Star` | `Square`

Specify the shape of the marker to draw. You can render the `Circle` and `Square` markers as outlines or as filled shapes.

Marker size — Size of marker

`3` (default) | `positive integer`

Specify the size of the marker as a positive integer, M , that defines a square area, with sides of length $2M+1$, into which the marker fits.

Filled — Filled marker

`off` (default) | `on`

Select this parameter to fill the marker with the specified intensity value or color.

Dependencies

To enable this parameter, set the **Marker shape** parameter to `Circle` or `Square`.

Border color source — Color source of marker border

`Specify via dialog` (default) | `Input port`

Specify the source of the color for the border of the marker as one these options:

- `Specify via dialog` — Use the **Border color** parameter to specify a color for the border of the marker.
- `Input port` — Use the **Clr** input port to specify a color for the border of the marker.

Dependencies

To enable this parameter, clear the **Filled** parameter or set the **Marker shape** parameter to X-mark, Plus, or Star.

Border color — Color value of marker

Black (default) | White | User-specified value

Specify the color value for the border of the marker as Black, White, or User-specified value.

Dependencies

To enable this parameter, clear the **Filled** parameter and set the **Border color source** parameter to Specify via dialog.

Fill color source — Color source of filled marker

Specify via dialog (default) | Input port

Specify the source of the color with which to fill the marker as one these options:

- Specify via dialog — Use the **Fill color** parameter to specify a color with which to fill the marker.
- Input port — Use the **Clr** input port to specify a color with which to fill the marker.

Dependencies

To enable this parameter, set the **Marker shape** parameter to Circle or Square and select the **Filled** parameter.

Fill color — Color value of filled marker

Black (default) | White | User-specified value

Specify the color value with which to fill the marker as Black, White, or User-specified value.

Dependencies

To enable this parameter, set the **Marker shape** parameter to Circle or Square, select the **Filled** parameter, and set the **Fill color source** parameter to Specify via dialog.

Opacity factor (between 0 and 1) — Opacity factor

0.6 (default) | scalar in range [0, 1] | K -element vector

Specify the opacity factor for the marker in the range [0, 1], where 0 is completely transparent and 1 is completely opaque. Specify this parameter as one of these options:

- Scalar — Apply the specified opacity factor to all markers.
- K -element Vector — Apply a different opacity factor to each marker. K is the number of markers.

Dependencies

To enable this parameter, set the **Marker shape** parameter to Circle or Square and select the **Filled** parameter.

Color value(s) — User-specified color values

[200 255 100] (default) | scalar | P -element vector | K -by- P matrix

Specify the color values for the markers. Use this table to determine the type of value to enter for this parameter.

Type of Input Image	Same Color for All Markers	Different Color for Each Marker
Intensity image	scalar value	K -element vector. K is the number of markers.
Color image	P -element vector. P is the number of color planes.	K -by- P matrix. P is the number of color planes and K is the number of markers.

Dependencies

To enable this parameter, use one of these options:

- The **Marker shape** parameter is set to X-mark, Plus, or Star, or the **Filled** parameter is cleared — Set the **Border color source** parameter to Specify via dialog and the **Border color** parameter to User-specified value.
- The **Marker shape** parameter is set to Circle or Square and the **Filled** parameter is selected — Set the **Fill color source** parameter to Specify via dialog and the **Fill color** parameter to User-specified value.

Draw Markers in — Area for markers

Entire image (default) | Specify region of interest via port

Specify where to draw the markers. By default, you can draw markers in the entire image. To specify markers within a rectangular ROI, set this parameter to Specify region of interest via port, and specify a four-element vector of the form [x y width height] to the **ROI** input port.

Use antialiasing — Smoothing algorithm

off (default) | on

Select this parameter to perform a smoothing algorithm on the Circle, X-mark, or Star marker shapes.

Dependencies

To enable this parameter, set the **Marker shape** parameter to Circle, X-mark, or Star.

Image signal — Port configuration for RGB image

One multidimensional signal (default) | Separate color signals

Specify how to input and output an RGB color image.

- One multidimensional signal — The block accepts input using only the **Image** port and returns the output using only the **Port_1** port.
- Separate color signals — The block accepts and returns the color image using three separate color channels, divided across the **R**, **G**, and **B** input and output ports.

Data Types

For details on the fixed-point block parameters, see “Specify Fixed-Point Attributes for Blocks”.

Block Characteristics

Data Types	Boolean double fixed point integer single
Multidimensional Signals	yes
Variable-Size Signals	yes

Extended Capabilities

C/C++ Code Generation

Generate C and C++ code using Simulink® Coder™.

See Also

Blocks

Draw Shapes

Functions

insertMarker | insertShape

Introduced before R2006a

Draw Shapes

Draw rectangles, lines, polygons, or circles on images

Library: Computer Vision Toolbox / Text & Graphics

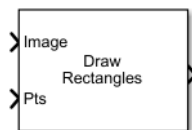

Description

The Draw Shapes block draws rectangles, lines, polygons, or circles on images by overwriting pixel values. As a result, the shapes are embedded in the output image. The block uses Bresenham's line drawing algorithm to draw lines, polygons, and rectangles and Bresenham's circle drawing algorithm to draw circles. The output signal is the same size and data type as the inputs to the **Image**, **R**, **G**, and **B** ports.

You can set the shape fill or border color via the input port or by manually entering the values in the Block Parameters window. Use the color parameters to determine the appearance of the rectangles, lines, polygons, or circles.

Ports

Input

Image — Input image

M-by-*N* matrix of intensity values | *M*-by-*N*-by-*P* color values

Input image, specified as either an *M*-by-*N* matrix of intensity values or an *M*-by-*N*-by-*P* matrix of color values with *P* color planes.

Data Types: `single` | `double` | `int8` | `int16` | `int32` | `int64` | `uint8` | `uint16` | `uint32` | `uint64` | `Boolean` | `fixed point`

R — Red video stream

scalar | vector | matrix

Red video stream, specified as a scalar, vector, or a matrix. The input represents one plane of the RGB video stream. The **R**, **G**, and **B** ports must have the same dimensions and data type.

Dependencies

To enable this port, set the **Image signal** parameter to `Separate color signals`.

Data Types: `single` | `double` | `int8` | `int16` | `int32` | `int64` | `uint8` | `uint16` | `uint32` | `uint64` | `Boolean` | `fixed point`

G — Green video stream

scalar | vector | matrix

Green video stream, specified as a scalar, vector, or a matrix. The input represents one plane of the RGB video stream. The **R**, **G**, and **B** ports must have the same dimensions and data type.

Dependencies

To enable this port, set the **Image signal** parameter to `Separate color signals`.

Data Types: `single | double | int8 | int16 | int32 | int64 | uint8 | uint16 | uint32 | uint64 | Boolean | fixed point`

B – Blue video stream

`scalar | vector | matrix`

Blue video stream, specified as a scalar, vector, or a matrix. The input represents one plane of the RGB video stream. The **R**, **G**, and **B** ports must have the same dimensions and data type.

Dependencies

To enable this port, set the **Image signal** parameter to `Separate color signals`.

Data Types: `single | double | int8 | int16 | int32 | int64 | uint8 | uint16 | uint32 | uint64 | Boolean | fixed point`

Pts – Shape coordinates

`M-by-3 matrix | M-by-4 matrix | M-by-2L`

Shape coordinates. The format of the points depends on the type of shape you specify with the **Shape** parameter.

- **Rectangles** — `M-by-4 matrix` of `M` rectangles. The format for each rectangle must be, `[x y width height]`.

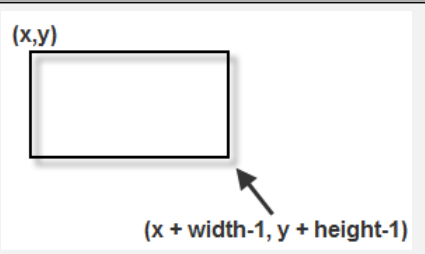
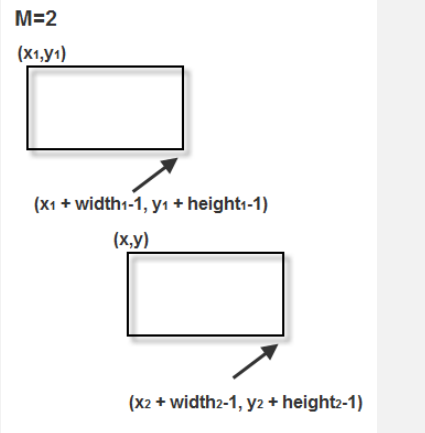
Shape	Input to the Pts Port	Drawn Shape
Single Rectangle	<p>Four-element row vector in the format <code>[x y width height]</code>, where:</p> <ul style="list-style-type: none"> • <code>x</code> and <code>y</code> are the one-based coordinates of the upper-left corner of the rectangle. • <code>width</code> and <code>height</code> are the width and height in pixels, of the rectangle. The values of <code>width</code> and <code>height</code> must be greater than 0. 	
<code>M</code> Rectangles	<p><code>M-by-4 matrix</code> in the format</p> $\begin{bmatrix} x_1 & y_1 & width_1 & height_1 \\ x_2 & y_2 & width_2 & height_2 \\ \vdots & \vdots & \vdots & \vdots \\ x_M & y_M & width_M & height_M \end{bmatrix}$ <p>,where each row of the matrix corresponds to a different rectangle and is of the same form as the vector for a single rectangle.</p>	<p><code>M=2</code></p> 

- **Lines** — `M-by-2L matrix` of `M` polylines. The format for each polyline must be of the form `[x1,y1,x2,y2,...,xL,yL]`.

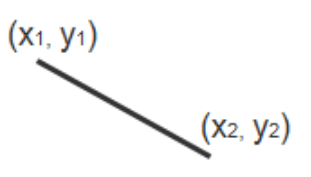
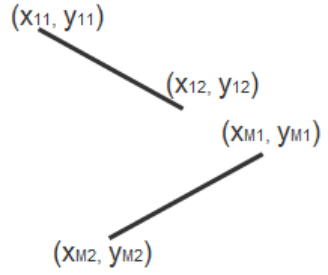
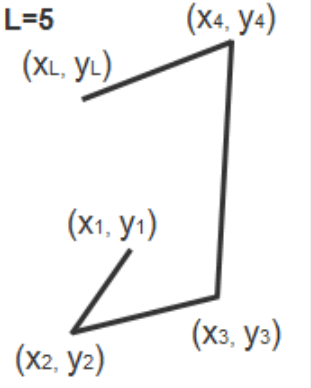
Shape	Input to the Pts Port	Drawn Shape
Single Line	<p>Four-element row vector in the format $[x_1 \ y_1 \ x_2 \ y_2]$, where:</p> <ul style="list-style-type: none"> x_1 and y_1 are the coordinates of the beginning of the line. x_2 and y_2 are the coordinates of the end of the line. 	
M Lines	<p>M-by-4 matrix in the format</p> $\begin{bmatrix} x_{11} & y_{11} & x_{12} & y_{12} \\ x_{21} & y_{21} & x_{22} & y_{22} \\ \vdots & \vdots & \vdots & \vdots \\ x_{M1} & y_{M1} & x_{M2} & y_{M2} \end{bmatrix}$ <p>,where each row of the matrix corresponds to a different line and is of the same form as the vector for a single line.</p>	
Single Polyline with (L-1) Segments	<p>Vector of size $2L$, where L is the number of vertices, in the format, $[x_1, \ y_1, \ x_2, \ y_2, \ \dots, \ x_L, \ y_L]$, where</p> <ul style="list-style-type: none"> x_1 and y_1 are the coordinates of the beginning of the first line segment. x_2 and y_2 are the coordinates of the end of the first line segment and the beginning of the second line segment. x_L and y_L are the coordinates of the end of the $(L-1)^{th}$ line segment. <p>The polyline always contains $(L-1)$ number of segments because the first and last vertex points do not connect. The block produces an error message when the number of rows is less than two or not a multiple of two.</p>	<p>L=5</p> 

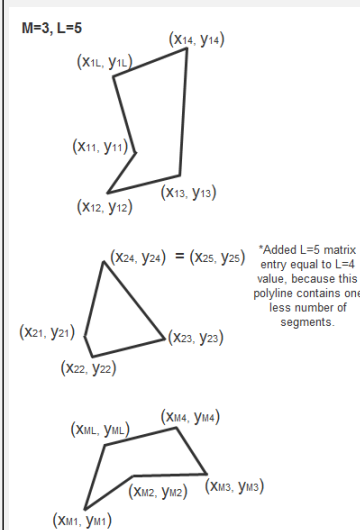
Shape	Input to the Pts Port	Drawn Shape
<i>M</i> Polylines with (<i>L</i> -1) Segments	<p><i>M</i>-by-<i>2L</i> matrix in the format</p> $\begin{bmatrix} x_{11} & y_{11} & x_{12} & y_{12} & \cdots & x_{1L} & y_{1L} \\ x_{21} & y_{21} & x_{22} & y_{22} & \cdots & x_{2L} & y_{2L} \\ \vdots & \vdots & \vdots & \vdots & \ddots & \vdots & \vdots \\ x_{M1} & y_{M1} & x_{M2} & y_{M2} & \cdots & x_{ML} & y_{ML} \end{bmatrix}$ <p>, where each row of the matrix corresponds to a different polyline and is of the same form as the vector for a single polyline. When you require one polyline to contain less than (<i>L</i>-1) number of segments, fill the matrix by repeating the coordinates of the last vertex.</p> <p>The block produces an error message if the number of rows is less than two or not a multiple of two.</p>	<p><i>M</i>=3, <i>L</i>=5</p> 

- **Polygons** — *M*-by-*2L* matrix of *M* polygons. The format for each polygon must be of the form [*x*₁,*y*₁,*x*₂,*y*₂,...,*x*_{*L*},*y*_{*L*}]. The points are specified in consecutive order to form a polygon.

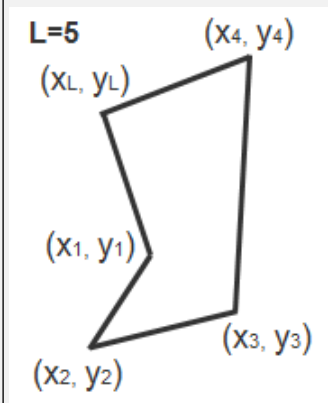
Shape	Input to the Pts Port	Drawn Shape
Single Polygon with <i>L</i> line segments	<p>Row vector of size <i>2L</i>, where <i>L</i> is the number of vertices, in the format [<i>x</i>₁ <i>y</i>₁ <i>x</i>₂ <i>y</i>₂ ... <i>x</i>_{<i>L</i>} <i>y</i>_{<i>L</i>}], where:</p> <ul style="list-style-type: none"> • <i>x</i>₁ and <i>y</i>₁ are the coordinates of the beginning of the first line segment. • <i>x</i>₂ and <i>y</i>₂ are the coordinates of the end of the first line segment and the beginning of the second line segment. • <i>x</i>_{<i>L</i>} and <i>y</i>_{<i>L</i>} are the coordinates of the end of the (<i>L</i>-1)th line segment and the beginning of the <i>L</i>th line segment. <p>The block connects [<i>x</i>₁ <i>y</i>₁] to [<i>x</i>_{<i>L</i>} <i>y</i>_{<i>L</i>}] to complete the polygon. The block produces an error if the number of rows is negative or not a multiple of two.</p>	<p><i>L</i>=5</p> 

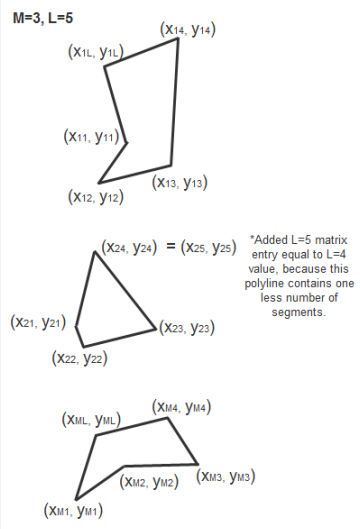
Shape	Input to the Pts Port	Drawn Shape
<p>M Polygons with the largest number of line segments in any line being L</p>	<p>M-by-$2L$ matrix in the format</p> $\begin{bmatrix} x_{11} & y_{11} & x_{12} & y_{12} & \cdots & x_{1L} & y_{1L} \\ x_{21} & y_{21} & x_{22} & y_{22} & \cdots & x_{2L} & y_{2L} \\ \vdots & \vdots & \vdots & \vdots & \ddots & \vdots & \vdots \\ x_{M1} & y_{M1} & x_{M2} & y_{M2} & \cdots & x_{ML} & y_{ML} \end{bmatrix}$ <p>, where each row of the matrix corresponds to a different polygon and is of the same form as the vector for a single polygon. If some polygons are shorter than others, repeat the ending coordinates to fill the polygon matrix.</p> <p>The block produces an error message if the number of rows is less than two or is not a multiple of two.</p>	<p>$M=3, L=5$</p> 

- **Circles** — M -by-3 matrix of M circles. The format for each circle must be, $[x \ y \ radius]$.

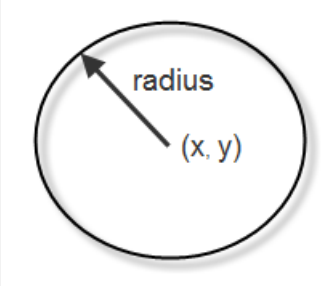
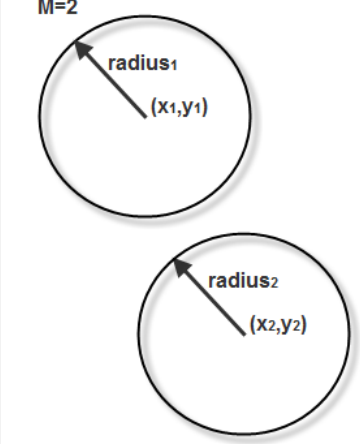
Shape	Input to the Pts Port	Drawn Shape
Single Circle	<p>Three-element row vector in the format $[x \ y \ radius]$, where:</p> <ul style="list-style-type: none"> • x and y are coordinates for the center of the circle. • $radius$ is the radius of the circle, which must be greater than 0. 	
M Circles	<p>M-by-3 matrix in the format</p> $\begin{bmatrix} x_1 & y_1 & radius_1 \\ x_2 & y_2 & radius_2 \\ \vdots & \vdots & \vdots \\ x_M & y_M & radius_M \end{bmatrix}$ <p>, where each row of the matrix corresponds to a different circle and is of the same form as the vector for a single circle.</p>	<p>$M=2$</p> 

Dependencies

- Double-precision floating point is only supported if the input to the **Image** or **R**, **G**, and **B** ports is floating point.
- Single-precision floating point (only supported if the input to the **Image** or **R**, **G**, and **B** ports is floating point).

Data Types: `single` | `double` | `int8` | `int16` | `int32` | `uint8` | `uint16` | `uint32`

ROI — Region of interest

four-element vector

Region of interest, specified as a four-element vector [`x y width height`]. The region defines a rectangular area to draw shapes. The first two elements represent the one-based coordinates of the upper-left corner of the area. The second two elements represent the width and height of the area.

Dependencies

To enable this port, set the **ROI** port appears when you set the **Draw shapes in** parameter to **Specify region of interest via port**.

Data Types: `single` | `double` | `int8` | `int16` | `int32` | `int64` | `uint8` | `uint16` | `uint32` | `uint64` | `Boolean` | `fixed point`

Clr — Color of shape

P -element vector | M -by- P matrix

Color of shape, specified as either a P -element vector or an M -by- P matrix of M number of shapes and P number of color planes. You can specify a color (RGB) for each shape, or specify one color for all shapes.

Dependencies

To enable this port, set the **Border color source** parameter to **Input port**.

Data Types: `single` | `double` | `int8` | `int16` | `int32` | `int64` | `uint8` | `uint16` | `uint32` | `uint64` | `Boolean` | `fixed point`

Output**Port_1 — Output image**

scalar | vector | matrix

Output image, returned as a scalar, vector, or matrix.

Data Types: `single` | `double` | `int8` | `int16` | `int32` | `int64` | `uint8` | `uint16` | `uint32` | `uint64` | `Boolean` | `fixed point` | `enumerated` | `bus`

Parameters**Main Tab****Fill Shapes — Fill color**

`off` (default) | `on`

Select **Fill Shapes** to specify an intensity value or a color.

Note If you are generating code and you select the **Fill shapes** check box, the word length of the block input(s) cannot exceed 16 bits.

Fill color source — Source for fill color

Specify via dialog (default) | Input port

Specify the source for the fill color value to either Specify via dialog or Input port.

Dependencies

To enable this parameter, select **Fill shapes**.

Fill color — Shape fill color

Black (default) | White | User-specified value

Specify the shape fill color.

Dependencies

To enable this parameter, select the **Fill shapes** parameter.

Border color source — Border color source

(default) |

Specify the source for the border color value to either Specify via dialog or Input port.

Dependencies

To enable this parameter, select the **Fill shapes** parameter.

Border color — Border color

Black (default) | White | User-specified value

Specify the appearance of the shape's border. You can specify Black, White, or User-specified value. This table describes what to enter for the color value based on the block input and the number of shapes you are drawing.

Block Input	Color Value(s) for Drawing One Shape or Multiple Shapes with the Same Color	Color Value(s) for Drawing Multiple Shapes with Unique Colors
Intensity image	Scalar intensity value	R -element vector where R is the number of shapes
Color image	P -element vector where P is the number of color planes	R -by- P matrix where P is the number of color planes and R is the number of shapes

For each value in the **Color Value(s)** parameter, enter a number between the minimum and maximum values that can be represented by the data type of the input image. If you enter a value outside this range, the block produces an error message.

Dependencies

To enable this parameter, clear the **Fill shapes** parameter.

Color value(s) – Color value

color value | intensity value

Specify an intensity or color value for the shape's border or fill.

Tunable: Yes

Dependencies

To enable this parameter set the **Border color** or **Fill color** parameter to User-specified value.

Opacity factor (between 0 and 1) – Opacity factorvalue in the range [0,1] | *R*-element vector

Specify the opacity of the shading inside the shape, where 0 is transparent and 1 is opaque.

Opacity Factor value for Drawing One Shape or Multiple Shapes with the Same Color	Opacity Factor value for Drawing Multiple Shapes with Unique Colors
Scalar intensity value	<i>R</i> -element vector where <i>R</i> is the number of shapes

Dependencies

To enable this parameter, clear the **Fill shapes** parameter.

Use antialiasing – Smoothing algorithm

off | on

Perform a smoothing algorithm on the line, polygon, or circle.

Dependencies

- To enable this parameter, set the **Shape** parameter to either Lines, Polygons, or Circles.

Image Signal – Image signal

Specify how to input and output a color video signal. Select the color video signal as one of the following:

- One multidimensional signal** – The block accepts an *M*-by-*N*-by-*P* color video signal, where *P* is the number of color planes, at one port.
- Separate color signals** – Enables the **R**, **G**, and **B** input ports. Each port accepts one *M*-by-*N* plane of an RGB video stream.

Data Types Tab

For details on the fixed-point block parameters, see “Specify Fixed-Point Attributes for Blocks”.

Block Characteristics

Data Types	Boolean double fixed point integer single
Multidimensional Signals	yes

Variable-Size Signals	yes
------------------------------	-----

Extended Capabilities

C/C++ Code Generation

Generate C and C++ code using Simulink® Coder™.

Fixed-Point Conversion

Design and simulate fixed-point systems using Fixed-Point Designer™.

See Also

[Draw Markers](#) | [Insert Text](#)

Introduced before R2006a

Edge Detection

Find edges of objects in images using Sobel, Prewitt, Roberts, or Canny method

Library: Computer Vision Toolbox / Analysis & Enhancement

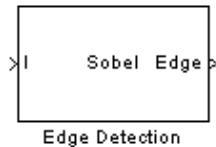

Description

The Edge Detection block finds edges of objects in an input image. The block supports four methods: Sobel, Prewitt, Roberts, and Canny. The first three methods find the edges by approximating the gradient magnitude of the image. The block convolves the input matrix with the Sobel, Prewitt, or Roberts kernel respectively, and outputs the resulting gradient components of the image. Additionally, the block outputs a binary image of the edge detections by thresholding the gradient magnitude.

The Canny method computes the gradient of input image using the derivative of the Gaussian filter. It then finds edges by looking for the local maxima of the gradient. This method uses two thresholds to detect the strong and weak edges. The weak edges are part of the output only if they are connected to strong edges. The block outputs a binary image of the edge detections for this method.

Ports

Input

I — Input image

matrix

Input image, specified as a matrix of intensity values.

Data Types: `single` | `double` | `int8` | `int16` | `int32` | `int64` | `uint8` | `uint16` | `uint32` | `uint64` | `fixed point`

Note The Canny method does not support 8-bit, 16-bit, or 32-bit signed fixed-point integers or 8-bit, 16-bit, or 32-bit unsigned integers.

Th — Threshold

scalar | vector

Specify a threshold as a scalar or a two-element vector to detect edges from the gradient. The data type of this value must match the input image data type. For the Canny edge detection method, the threshold must be a two-element vector in the range [0 1]. For the other methods, the threshold is a scalar.

Dependencies

To enable this port:

- Set the **Method** parameter to Canny. Alternatively, set the **Method** parameter to Sobel, Prewitt, or Roberts, and also set the **Output type** parameter to Binary image or Binary image and gradient components.
- Select the **User-defined threshold**.
- Set the **Threshold source** parameter to Input port.

Data Types: single | double | int8 | int16 | int32 | int64 | uint8 | uint16 | uint32 | uint64 | fixed point

Note The Canny method does not support 8-bit, 16-bit, or 32-bit signed fixed-point integers or 8-bit, 16-bit, or 32-bit unsigned integers.

Output

Edge — Edge detections

matrix

Edge detections, returned as a binary image. The pixels with the value of 1 represent the edge pixels.

Dependencies

This port is always enabled when you set the **Method** parameter to Canny. To enable this port for the Sobel, Prewitt, or Roberts methods, set the **Output type** parameter to Binary image or Binary image and gradient components.

Data Types: Boolean

Gv — Gradient responses to vertical edges

matrix

Matrix of gradient responses to the vertical edges.

Dependencies

To enable this port, set these parameters:

- **Method** — Sobel or Prewitt
- **Output type** — Gradient components or Binary image and gradient components

Data Types: single | double | int8 | int16 | int32 | int64 | uint8 | uint16 | uint32 | uint64 | fixed point

Gh — Gradient responses to horizontal edges

matrix

Matrix of gradient responses to the horizontal edges.

Dependencies

To enable this port, set these parameters:

- **Method** — Sobel or Prewitt
- **Output type** — Gradient components or Binary image and gradient components

Data Types: `single` | `double` | `int8` | `int16` | `int32` | `int64` | `uint8` | `uint16` | `uint32` | `uint64` | `fixed point`

G45 — Gradient responses to edges at 45 degrees

matrix

Matrix of gradient responses to edges at 45 degrees.

Dependencies

To enable this port, set these parameters:

- **Method** — Roberts
- **Output type** — Gradient components or Binary image and gradient components

Data Types: `single` | `double` | `int8` | `int16` | `int32` | `int64` | `uint8` | `uint16` | `uint32` | `uint64` | `fixed point`

G135 — Gradient responses to edges at 135 degrees

matrix

Matrix of gradient responses to edges at 135 degrees.

Dependencies

To enable this port, set these parameters:

- **Method** — Roberts
- **Output type** — Gradient components or Binary image and gradient components

Data Types: `single` | `double` | `int8` | `int16` | `int32` | `int64` | `uint8` | `uint16` | `uint32` | `uint64` | `fixed point`

Parameters

Main

Method — Edge detection method

`Sobel` (default) | `Prewitt` | `Roberts` | `Canny`

Specify a method to detect edges in the input image. You can choose from Sobel, Prewitt, Roberts or Canny.

Output Type — Output image type

`Binary image` (default) | `Gradient components` | `Binary image and gradient components`

Specify the type of output image from one of these options:

- `Binary image` — The block outputs a Boolean matrix at the **Edge** port. The elements of the matrix labeled 1 represent the edge pixels.
- `Gradient components` — The block outputs the gradient components. For the Sobel and Prewitt methods, the gradient components correspond to the horizontal and vertical edge responses at the **Gh** and **Gv** ports respectively. For the Roberts method the gradient components correspond to 45 degree and 135 degree edge responses at the **G45** and **G135** ports respectively.

- **Binary image and gradient components** — The block outputs both the binary image and the gradient components of the image

Dependencies

To enable this parameter, set the **Method** parameter to Sobel, Prewitt, or Roberts.

User-defined threshold — User-defined threshold

off (default) | on

Specify a desired threshold value via dialog or the **Th** port.

Dependencies

This parameter is always enabled when you set the **Method** parameter to Canny. To enable this parameter for the Sobel, Prewitt, or Roberts methods, set the **Output type** parameter to Binary image or Binary image and gradient components.

Threshold source — Threshold source

Input port (default) | Specify via dialog

Select the source to enter the threshold value from one of these options:

- **Input port** — Specify a threshold value using the **Th** port. The data type of this value must match the input image data type.
- **Specify via dialog** — Enter the desired threshold value in the dialog box.

Dependencies

To enable this parameter:

- Set the **Method** parameter to Canny. Alternatively set the **Method** parameter to Sobel, Prewitt, or Roberts, and also set the **Output type** parameter to Binary image or Binary image and gradient components.
- Select the **User-defined threshold**.

Threshold — Threshold

20 (default) | scalar

Specify the threshold value that is within the range of your input data. This threshold applies to Sobel, Prewitt, and Roberts edge detection methods.

Dependencies

To enable this parameter, set these block parameters:

- **Method** — Sobel, Prewitt, or Roberts
- **Output type** — Binary image or Binary image and gradient components
- **User-defined threshold** — On.
- **Threshold source** — Specify via dialog

Threshold, [Low High] — Threshold for Canny edge detection

[0.25 0.60] (default) | vector

Specify the threshold for the Canny edge detection as a two-element vector in the range [0 1]. The elements of the vector specifies the low and high threshold values for the weak and strong edges respectively.

Dependencies

To enable this parameter, set these block parameters:

- **Method** — Canny
- **User-defined threshold** — On.
- **Threshold source** — Specify via dialog

Threshold scale factor:(used to automatically calculate threshold value) — Threshold scale factor

4 (default) | scalar

Specify the threshold scale factor to automatically calculate threshold value. The block computes the automatic threshold using the mean of the gradient magnitude squared image and multiplies the value of this parameter with the automatic threshold value to determine a new threshold value.

Dependencies

To enable this parameter, set these block parameters:

- **Method** — Sobel, Prewitt, or Roberts
- **Output type** — Binary image or Binary image and gradient components
- **User-defined threshold** — Off

Edge Thinning — Edge thinning

off (default) | on

Select this parameter to reduce the thickness of the edges in your output images. This option requires additional processing time and memory resources.

Tip This block is most efficient in terms of memory usage and processing time when you clear the **Edge thinning** check box and use the **Threshold** parameter to specify a threshold value.

Dependencies

To enable this parameter, set these block parameters:

- **Method** — Sobel, Prewitt, or Roberts
- **Output type** — Binary image or Binary image and gradient components

Approximate percentage of weak edge and nonedge pixels (used to automatically calculate threshold values) — Approximate percentage of weak edge and nonedge pixels

70 (default) | scalar

Specify the approximate percentage of weak edge and nonedge image pixels. The block computes the automatic threshold values using this value.

Dependencies

To enable this parameter, set these block parameters:

- **Method** — Canny
- **User-defined threshold** — Off

Standard deviation of Gaussian filter — Standard deviation of Gaussian filter

1 (default) | scalar

Specify the standard deviation of Gaussian filter used for Canny edge detection algorithm.

Dependencies

To enable this parameter, set the **Method** parameter to Canny.

Data Types

For information about the fixed-point block parameters, see “Specify Fixed-Point Attributes for Blocks” .

Block Characteristics

Data Types	double fixed point integer single
Multidimensional Signals	no
Variable-Size Signals	yes

References

[1] Gonzales, Rafael C. and Richard E. Woods. *Digital Image Processing, 2nd ed.* Englewood Cliffs, NJ: Prentice Hall, 2002.

[2] Pratt, William K. *Digital Image Processing, 2nd ed.* NY: John Wiley & Sons, 1991.

Extended Capabilities**C/C++ Code Generation**

Generate C and C++ code using Simulink® Coder™.

Fixed-Point Conversion

Design and simulate fixed-point systems using Fixed-Point Designer™.

When you select the **Normalized output** check box, the block input cannot be fixed point.

See Also

edge | edge3

Introduced before R2006a

Erosion

Find local minima in binary or intensity image

Library: Computer Vision Toolbox / Morphological Operations



Description

The Erosion block slides a neighborhood or structuring element over an image, finds the local minima, and creates an output matrix from these minimum values. If the neighborhood or structuring element has a center element, the block places the minima there, as shown in this figure.

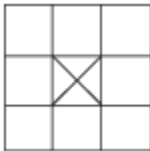

If the neighborhood or structuring element does not have an exact center, the block has a bias toward the upper-left of the central elements and places the minima there, as shown in this figure.

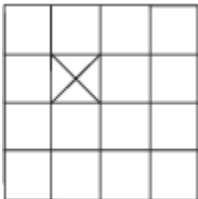

This block uses flat structuring elements only.

Ports

Input

I — Input image

matrix

Specify an input image as a matrix of binary or intensity values. This port is unnamed until you set the **Neighborhood or structuring element source** parameter to Input port.

Data Types: single | double | int8 | int16 | int32 | uint8 | uint16 | uint32 | Boolean | fixed point

Nhood — Neighborhood values

vector | matrix

Specify neighborhood values, representing a structuring element, as a vector or matrix of 1s and 0s.

Dependencies

To enable this port, set the **Neighborhood or structuring element source** parameter to Input port.

Data Types: Boolean

Output

Port_1 — Eroded image

matrix

Eroded image, returned as a matrix. The size and data type of the output image are the same as those of the input image.

Data Types: single | double | int8 | int16 | int32 | uint8 | uint16 | uint32 | Boolean | fixed point

Parameters

Neighborhood or structuring element source — Source of neighborhood or structuring element

Specify via dialog (default) | Input port

Specify the source of the neighborhood or structuring element as one of these options:

- **Specify via dialog** — Use the **Neighborhood or structuring element** parameter to specify a neighborhood or structuring element.
- **Input port** — Use the **Nhood** input port to specify neighborhood values representing a structuring element.

Neighborhood or structuring element — Neighborhood or structuring element

strel('square',4) (default)

Specify the neighborhood or structuring element as a vector or matrix of 1s and 0s, a strel object, or an array of strel objects. When you specify an array of strel objects, the block applies each object to the entire image in sequence.

If the structuring element is decomposable into smaller elements, the block execution speed improves due to the more efficient algorithm.

Dependencies

To enable this parameter, set the **Neighborhood or structuring element source** parameter to Specify via dialog.

Block Characteristics

Data Types	Boolean double fixed point integer single
Multidimensional Signals	no
Variable-Size Signals	yes

References

[1] Soille, Pierre. *Morphological Image Analysis*. Berlin, Heidelberg: Springer Berlin Heidelberg, 2004. <https://doi.org/10.1007/978-3-662-05088-0>.

Extended Capabilities

C/C++ Code Generation

Generate C and C++ code using Simulink® Coder™.

See Also

Blocks

Dilation | Opening | Closing | Label | Bottom-hat | Top-hat

Functions

imerode | imdilate | imopen | imclose

Objects

strel

Introduced before R2006a

Estimate Geometric Transformation

Estimate geometric transformation from matching point pairs

Library: Computer Vision Toolbox / Geometric Transformations

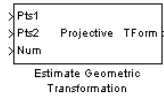

Description

Use the Estimate Geometric Transformation block to find the transformation matrix which maps the greatest number of point pairs between two images. A point pair refers to a point in the input image and its related point on the image created using the transformation matrix. You can select to use the RANdom SAMple Consensus (RANSAC) or the Least Median Squares algorithm to exclude outliers and to calculate the transformation matrix. You can also use all input points to calculate the transformation matrix.

Ports

Input

Pts1 — Point coordinates

M-by-2 matrix

Point coordinates, specified as an *M*-by-2 matrix of one-based [*x* *y*] point coordinates, where *M* represents the number of points.

The block outputs the same data type for the transformation matrix as the **Pts1** and **Pts2** image points.

Data Types: single | double | int8 | int16 | int32 | uint8 | uint16 | uint32

Pts2 — Point coordinates

M-by-2 matrix

Point coordinates, specified as an *M*-by-2 matrix of one-based [*x* *y*] point coordinates, where *M* represents the number of points.

The block outputs the same data type for the transformation matrix as the **Pts1** and **Pts2** image points.

Data Types: single | double | int8 | int16 | int32 | uint8 | uint16 | uint32

Num — Number of valid points

scalar

Number of valid points to find in **Pts1** and **Pts2**, specified as a scalar. This port appears when you enable the **Allow variable-size signal input** parameter.

Data Types: int8 | int16 | int32 | uint8 | uint16 | uint32

Output

TForm — Transformation

3-by-2 matrix | 3-by-3 matrix

Transformation, returned as either a 3-by-2 or a 3-by-3 matrix. The block outputs the same data type for the transformation matrix as the **Pts1** and **Pts2** image points.

Dependencies

- When **Pts1** and **Pts2** are single or double, the output transformation matrix will also have single or double data type.
- When **Pts1** and **Pts2** images are built-in integers, the option is available to set the transformation matrix data type to either `Single` or `Double`.

Data Types: `single` | `double`

Inlier — Points used

M-by-1 vector

Points used to calculate `TForm`, returned as an *M*-by-1 vector.

Dependencies

- The **Inlier** port appears when you enable the **Output Boolean signal indicating which point pairs are inliers** parameter.

Data Types: `Boolean`

Parameters

Transformation type — Transformation type

`Affine` (default) | `Nonreflective similarity` | `Projective`

Specify the transformation type as either `Nonreflective similarity`, `Affine`, or `Projective`. See “Transformations” on page 1-202 for a more detailed discussion.

Dependencies

You can set additional parameters depending on the transformation type:

- For `Projective` transformation, you can specify a scalar algebraic distance threshold for determining inliers.
- For `Affine` or `Nonreflective similarity` transformation, you can specify the distance threshold for determining inliers in pixels.

Find and exclude outliers — Find and exclude outliers

`on` (default) | `off`

Enable to find and exclude outliers from the input points and use only the inlier points to calculate the transformation matrix. When you turn this parameter off, all input points are used to calculate the transformation matrix.

Method — Method to find outliers

`RANdom SAmples Consensus (RANSAC)` (default) | `Least Median of Squares`

Select the method to find outliers as either RANdom SAMple Consensus (RANSAC) or Least Median of Squares. See “RANSAC and Least Median Squares Algorithms” on page 1-201 for a more detailed discussion.

Dependencies

This parameter appears when you enable the **Find and exclude outliers** check box.

Algebraic distance threshold for determining inliers – Algebraic distance threshold for determining inliers

1.5 (default) | scalar

Specify a scalar threshold value for determining inliers. The threshold controls the upper limit used to find the algebraic distance in the RANSAC algorithm.

Dependencies

This parameter appears when you set the **Method** parameter to Random Sample Consensus (RANSAC) and the **Transformation type** parameter to Projective.

Distance threshold for determining inliers (in pixels) – Distance threshold for determining inliers (in pixels)

1.5 (default) | scalar

Specify the upper limit distance a point can differ from the projection location of its corresponding point.

Dependencies

This parameter appears when you set the **Method** parameter to Random Sample Consensus (RANSAC) and you set the value of the **Transformation type** parameter to Nonreflective similarity or Affine.

Determine number of random samplings using – Determine number of random samplings using

Specified value (default) | Desired confidence

Select **Specified value** to enter a positive integer value for the number of random samplings. Select **Desired confidence** to set the number of random samplings as a percentage and a maximum number.

Dependencies

This parameter appears when you select the **Find and exclude outliers** check box, and you set the value of the **Method** parameter to Random Sample Consensus (RANSAC).

Number of random samplings – Number of random samplings

500 (default) | scalar

Specify the number of random samplings for the algorithm to perform.

Dependencies

This parameter appears when you set the value of the **Determine number of random samplings using** parameter to **Specified value**.

Desired confidence (in %) – Desired confidence (in %)

99 (default) | scalar

Specify a percent desired confidence by entering a number between 0 and 100. The value represents the probability of the algorithm to find the largest group of points that can be mapped by a transformation matrix.

Dependencies

This parameter appears when you set the **Determine number of random samplings using** parameter to `Desired confidence`.

Maximum number of random samplings — Maximum number of random samplings

1000 (default) | integer

Specify an integer number for the maximum number of random samplings.

Dependencies

This parameter appears when you set the **Method** parameter to `Random Sample Consensus (RANSAC)` and you set the value of the **Determine number of random samplings using** parameter to `Desired confidence`.

Stop sampling earlier when a specified percentage of point pairs are determined to be inlier — Stop sampling

off (default) | on

Enable this parameter to stop random sampling when a percentage of input points have been found as inliers.

Dependencies

This parameter appears when you set the **Method** parameter to `Random Sample Consensus (RANSAC)`.

Perform additional iterative refinement of the transformation matrix — Perform additional iterative refinement

off (default) | on

Specify whether to perform refinement on the transformation matrix.

Dependencies

This parameter appears when you select **Find and exclude outliers** check box.

Output Boolean signal indicating which point pairs are inliers — Output Boolean signal

off (default) | on

Enable this parameter to output the inlier point pairs that were used to calculate the transformation matrix.

Dependencies

- This parameter appears when you select the **Find and exclude outliers** check box.
- The block will not use this parameter with signed or double, data type points.

When Pts1 and Pts2 are built-in integers, set transformation matrix data type to — Set transformation matrix data type

Single (default) | Double

Specify transformation matrix data type as `Single` or `Double` when the input points are built-in integers.

Dependencies

The block will not use this parameter with signed or double, data type points.

Allow variable-sized signal input — Allow variable-sized signal input

on (default) | off

Enable this parameter to allow variable-sized signal input.

Dependencies

Block Characteristics

Data Types	double integer ^a single
Multidimensional Signals	no
Variable-Size Signals	yes

a. Generated code will be restricted to MATLAB host computers when you set the FFT implementation parameter to `FFTW`, or when the transform length is not a power of two.

Algorithms

RANSAC and Least Median Squares Algorithms

The RANSAC algorithm relies on a distance threshold. A pair of points, p_i^a (image a , Pts1) and p_i^b (image b , Pts2) is an inlier only when the distance between p_i^b and the projection of p_i^a based on the transformation matrix falls within the specified threshold. The distance metric used in the RANSAC algorithm is as follows:

$$d = \sum_{i=1}^{Num} \min(D(p_i^b, \psi(p_i^a: H)), t)$$

The Least Median Squares algorithm assumes at least 50% of the point pairs can be mapped by a transformation matrix. The algorithm does not need to explicitly specify the distance threshold. Instead, it uses the median distance between all input point pairs. The distance metric used in the Least Median of Squares algorithm is as follows:

$$d = \text{median}(D(p_1^b, \psi(p_1^a: H)), D(p_2^b, \psi(p_2^a: H)), \dots, D(p_{Num}^b, \psi(p_N^a: H)))$$

For both equations:

p_i^a is a point in image a (Pts1)

p_i^b is a point in image b (Pts2)

$\psi(p_i^a: H)$ is the projection of a point on image a based on transformation matrix H

$D(p_i^b, p_j^b)$ is the distance between two point pairs on image b

t is the threshold

Num is the number of points

The smaller the distance metric, the better the transformation matrix and therefore the more accurate the projection image.

Transformations

The Estimate Geometric Transformation block supports **Nonreflective similarity**, **Affine**, and **Projective** transformation types, which are described in this section.

Nonreflective similarity transformation supports translation, rotation, and isotropic scaling. It has four degrees of freedom and requires two pairs of points.

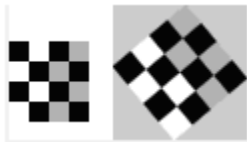

The transformation matrix is:
$$H = \begin{bmatrix} h_1 & -h_2 \\ h_2 & h_1 \\ h_3 & h_4 \end{bmatrix}$$

The projection of a point $[x \ y]$ by H is: $[\hat{x} \ \hat{y}] = [x \ y \ 1]H$

affine transformation supports nonisotropic scaling in addition to all transformations that the nonreflective similarity transformation supports. It has six degrees of freedom that can be determined from three pairs of noncollinear points.



The transformation matrix is:
$$H = \begin{bmatrix} h_1 & h_4 \\ h_2 & h_5 \\ h_3 & h_6 \end{bmatrix}$$

The projection of a point $[x \ y]$ by H is: $[\hat{x} \ \hat{y}] = [x \ y \ 1]H$

Projective transformation supports tilting in addition to all transformations that the affine transformation supports.



The transformation matrix is:
$$h = \begin{bmatrix} h_1 & h_4 & h_7 \\ h_2 & h_5 & h_8 \\ h_3 & h_6 & h_9 \end{bmatrix}$$

The projection of a point $[x \ y]$ by H is represented by homogeneous coordinates as:

$$[\hat{u} \ \hat{v} \ \hat{w}] = [x \ y \ 1]H$$

Distance Measurement

For computational simplicity and efficiency, this block uses algebraic distance. The algebraic distance for a pair of points, $[x^a \ y^a]^T$ on image a , and $[x^b \ y^b]$ on image b , according to transformation H , is defined as follows;

For projective transformation:

$$D(p_i^b, \psi(p_i^a: H)) = ((\hat{u}^a - \hat{w}^a x^b)^2 + (\hat{v}^a - \hat{w}^a y^b)^2)^{\frac{1}{2}}, \text{ where } [\hat{u}^a \ \hat{v}^a \ \hat{w}^a] = [x^a \ y^a \ 1]H$$

For Nonreflective similarity or affine transformation: $D(p_i^b, \psi(p_i^a: H)) = ((\hat{x}^a - x^b)^2 + (\hat{y}^a - \hat{y}^b)^2)^{\frac{1}{2}}$,

where $[\hat{x}^a \ \hat{y}^a] = [x^a \ y^a \ 1]H$

Algorithm

The block performs a comparison and repeats it K number of times between successive transformation matrices. If you select the **Find and exclude outliers** option, the RANSAC and Least Median Squares (LMS) algorithms become available. These algorithms calculate and compare a distance metric. The transformation matrix that produces the smaller distance metric becomes the new transformation matrix that the next comparison uses. A final transformation matrix is resolved when either:

- K number of random samplings is performed
- The RANSAC algorithm, when enough number of inlier point pairs can be mapped, (dynamically updating K)

The Estimate Geometric Transformation algorithm follows these steps:

- 1 A transformation matrix H is initialized to zeros
- 2 Set count = 0 (Randomly sampling).
- 3 While count < K , where K is total number of random samplings to perform, perform the following;
 - a Increment the count; count = count + 1.
 - b Randomly select pair of points from images a and b , (2 pairs for Nonreflective similarity, 3 pairs for affine, or 4 pairs for projective).
 - c Calculate a transformation matrix H , from the selected points.
 - d If H has a distance metric less than that of H , then replace H with H .

(Optional for RANSAC algorithm only)

- i Update K dynamically.
 - ii Exit out of sampling loop if enough number of point pairs can be mapped by H .
- 4 Use all point pairs in images a and b that can be mapped by H to calculate a refined transformation matrix H
- 5 Iterative Refinement, (Optional for RANSAC and LMS algorithms)

- a** Denote all point pairs that can be mapped by H as inliers.
- b** Use inlier point pairs to calculate a transformation matrix H .
- c** If H has a distance metric less than that of H , then replace H with H , otherwise exit the loop.

Number of Random Samplings

The number of random samplings can be specified by the user for the RANSAC and Least Median Squares algorithms. You can use an additional option with the RANSAC algorithm, which calculates this number based on an accuracy requirement. The **Desired Confidence** level drives the accuracy.

The calculated number of random samplings, K used with the RANSAC algorithm, is as follows:

$$K = \frac{\log(1 - p)}{\log(1 - q^s)}$$

where

- p is the probability of independent point pairs belonging to the largest group that can be mapped by the same transformation. The probability is dynamically calculated based on the number of inliers found versus the total number of points. As the probability increases, the number of samplings, K , decreases.
- q is the probability of finding the largest group that can be mapped by the same transformation.
- s is equal to the value 2, 3, or 4 for Nonreflective similarity, affine, and projective transformation, respectively.

Iterative Refinement of Transformation Matrix

The transformation matrix calculated from all inliers can be used to calculate a refined transformation matrix. The refined transformation matrix is then used to find a new set of inliers. This procedure can be repeated until the transformation matrix cannot be further improved. This iterative refinement is optional.

References

- [1] R. Hartley and A. Zisserman, "Multiple View Geometry in Computer Vision," Second edition, Cambridge University Press, 2003

Extended Capabilities

C/C++ Code Generation

Generate C and C++ code using Simulink® Coder™.

Fixed-Point Conversion

Design and simulate fixed-point systems using Fixed-Point Designer™.

See Also

cp2tform

Introduced in R2008a

Find Local Maxima

Find local maxima in matrices

Library: Computer Vision Toolbox / Statistics

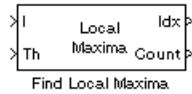

Description

The Find Local Maxima block finds the local maxima in a given input matrix. The block finds the local maxima of values within a region specified by the neighborhood size. The block compares the values in the search region to a user-specified threshold and identifies a value that is greater than or equal to the threshold as the local maximum. After finding the local maximum, the block sets all the matrix values in the neighborhood, including the maximum value, to zero. This step ensures that subsequent searches do not include this maximum. The process repeats until the block either finds all valid maxima or the specified number of local maxima.

The threshold and the neighborhood size must be chosen such that the block detects only the true local maxima and eliminates false peaks.

The input to this block can also be a Hough matrix generated from the Hough Transform block. The Find Local Maxima block outputs the one-based [x y] coordinates of the detected local maxima. The data sent to all input ports must be the same data type.

Ports

Input

I — Input

M-by-*N* matrix

Input, specified as the *M*-by-*N* matrix in which you want to detect the local maxima. If the input is a Hough matrix output from the Hough Transform block, select the **Input is Hough matrix spanning full theta range** parameter that renames this port as **Hough**.

Data Types: single | double | int8 | int16 | int32 | uint8 | uint16 | uint32 | fixed point

Th — Threshold for detecting local maxima

scalar

Threshold for the detecting local maxima, specified as a scalar.

Dependencies

To enable this port, set the **Source of threshold value** parameter to Input port.

Data Types: single | double | int8 | int16 | int32 | uint8 | uint16 | uint32 | fixed point

Output

Idx — Coordinates of local maxima

P-by-2 matrix

Coordinates of the local maxima, returned as a P -by-2 matrix of one-based $[x\ y]$ coordinates. P represents the number of local maxima.

Data Types: `single` | `double` | `uint8` | `uint16` | `uint32`

Count — Number of local maxima

scalar

Number of local maxima, returned as a scalar.

Dependencies

To enable this port, clear the check box for the **Output variable size signal** parameter.

Data Types: `single` | `double` | `uint8` | `uint16` | `uint32`

Parameters

Maximum number of local maxima — Maximum number of local maxima to detect

2 (default) | positive integer

Specify the maximum number of local maxima to detect in the input matrix. The value must be a positive integer greater than 0.

Neighborhood size — Size of neighborhood region

[5 7] (default) | two-element vector

Specify the size of the neighborhood region as a two-element vector in the form $[r\ c]$. The vector specifies the window size $r \times c$, within which the block determines the local maxima. The window size must be greater than or equal to 1×1 .

Source of threshold value — Source to enter the threshold value

Specify via dialog (default) | Input port

Specify the source for entering the threshold value. When you select the `Input port`, the block enables the **Th** port. When you select the `Specify via dialog`, the block enables the **Threshold** parameter.

Threshold — Threshold for detecting local maxima

10 (default) | scalar

Specify a scalar value that represents the threshold for detecting the local maxima.

Dependencies

To enable this parameter, set the **Source of threshold value** parameter to `Specify via dialog`.

Input is Hough matrix spanning full theta range — Whether input is a Hough matrix

off (default) | on

Select the parameter, if the input to this block is the Hough matrix output from the Hough Transform block. The Find Local Maxima block assumes that the input is a Hough matrix that is antisymmetric about the rho axis, with values of theta from $-\pi/2$ to $\pi/2$ radians. As a result, if the local maximum is near the boundary and its neighborhood region is outside the Hough matrix, the block detects only one local maximum. The block ignores the corresponding antisymmetric maximum.

Index output data type — Data type for coordinates of local maximums

uint32 (default) | double | single | uint8 | uint16

Specify the data type for the coordinates of local maximums returned at the output port **Idx**.

Output variable size signal — Support input signals of varying length

on (default) | off

Specify if the model supports input signals of varying length.

Count output data type — Data type for number of local maximums

uint32 (default) | double | single | uint8 | uint16

Specify the data type for the number of local maximums returned at the output port **Count**.

Dependencies

To enable this parameter, clear the **Output variable size signal** parameter.

Block Characteristics

Data Types	double fixed point integer single
Multidimensional Signals	no
Variable-Size Signals	yes

Extended Capabilities**C/C++ Code Generation**

Generate C and C++ code using Simulink® Coder™.

See Also**Blocks**

Hough Lines | Corner Detection

Functions

houghpeaks | hough

Introduced before R2006a

Frame Rate Display

Calculate and display video frame rate

Library: Computer Vision Toolbox / Sinks

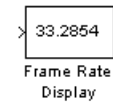

Description

The Frame Rate Display block calculates and displays the average update rate of an input signal. For an input video signal, this block displays the video frame rate of the simulation. The calculated rate is in relation to the wall clock time. For example, if the model is updating the input signal 30 times for every second, this block displays 30 on the block mask.

This block supports images and video frames as input. Inputs can contain intensity or color values.

Ports

Input

Port_1 — Input data

matrix | array

Input data, specified as an M -by- N matrix, M -by- N -by- T array, or M -by- N -by- C -by- T array. T is the number of frames in a video or image sequence, and C is the number of color channels.

Data Types: single | double | int8 | int16 | int32 | uint8 | uint16 | uint32 | Boolean | fixed point

Parameters

Update rate — Frequency of updates

10 (default) | positive scalar

Specify this parameter to control how often the block updates the display. The block displays the average update rate across the specified number of video frames. For example, if this parameter is set to 10, the Frame Rate Display block calculates the elapsed time to pass 10 video frames to the block, divides the elapsed time by 10, and displays the average video frame rate.

Note If the input port of Frame Rate Display block is not connected to a signal, the block displays the base (fastest) rate of the Simulink model.

Block Characteristics

Data Types	Boolean double fixed point integer single
-------------------	---

Multidimensional Signals	no
Variable-Size Signals	yes

See Also

Blocks

[To Multimedia File](#) | [To Video Display](#) | [Video To Workspace](#) | [Video Viewer](#)

Introduced before R2006a

From Multimedia File

Read video frames and audio samples from multimedia file

Library: Computer Vision Toolbox / Sources

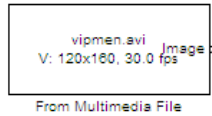

Description

The From Multimedia File block reads video frames, audio samples, or both from a multimedia file. The block imports data from a file, of a supported file format, into a Simulink model. For more information about supported file formats, see “Supported Platforms and File Formats” on page 1-216.

This block enables you to read WMA or WMV streams from your system or over a network connection. Similarly, the To Multimedia File block enables you to write WMA or WMV streams to your system or over a network connection. If your system does not have the codec necessary to support a file format, you must re-encode files of that format into a file format supported by the Computer Vision Toolbox.

If you have a Simulink Coder license, you can generate code from a model containing this block. To run a generated executable file, you may need to add precompiled shared library files to your system path. For more information, see “Simulink Shared Library Dependencies” and “Accelerating Simulink Models”.

Note This block supports code generation for a host computer that has file I/O available. You cannot use this block with Simulink Desktop Real-Time™ software because that product does not support file I/O.

Ports

Output

Image — Color image or video frame

array

Color image or video frame, returned as an M -by- N -by- P array. M and N are the number of rows and columns in each image. P is the number of color channels in each image.

Dependencies

To enable this port:

- Set the **File name** parameter to the name of a multimedia file that contains video or image data. If the specified file contains both audio and video data, set the **Multimedia outputs** parameter to Video only or Video and audio.
- Set the **Output color format** parameter to RGB and **Image signal** parameter to One multidimensional signal.

Data Types: `single` | `double` | `int8` | `int16` | `int32` | `uint8` | `uint16` | `uint32` | `Simulink.ImageType`

I — Grayscale image or video frame

`matrix`

Grayscale image or video frame, returned as an M -by- N matrix. M and N are the number of rows and columns in the grayscale image.

Dependencies

To enable this port:

- Set the **File name** parameter to the name of a multimedia file that contains video or image data. If the specified file contains both audio and video data, set the **Multimedia outputs** parameter to `Video only` or `Video and audio`.
- Set the **Output color format** parameter to `Intensity`.

Data Types: `single` | `double` | `int8` | `int16` | `int32` | `uint8` | `uint16` | `uint32`

R — Red color component of image or video frame

`matrix`

Red color component of the image or video frame, returned as an M -by- N matrix. M and N are the number of rows and columns in the image.

Dependencies

To enable this port:

- Set the **File name** parameter to the name of a multimedia file that contains video or image data. If the specified file contains both audio and video data, set the **Multimedia outputs** parameter to `Video only` or `Video and audio`.
- Set the **Output color format** parameter to `RGB` and **Image signal** parameter to `Separate color signals`.

Data Types: `single` | `double` | `int8` | `int16` | `int32` | `uint8` | `uint16` | `uint32`

G — Green color component of image or video frame

`matrix`

Green color component of the image or video frame, returned as an M -by- N matrix. M and N are the number of rows and columns in the image.

Dependencies

To enable this port:

- Set the **File name** parameter to the name of a multimedia file that contains video or image data. If the specified file contains both audio and video data, set the **Multimedia outputs** parameter to `Video only` or `Video and audio`.
- Set the **Output color format** parameter to `RGB` and **Image signal** parameter to `Separate color signals`.

Data Types: `single` | `double` | `int8` | `int16` | `int32` | `uint8` | `uint16` | `uint32`

B — Blue color component of image or video frame

matrix

Blue color component of the image or video frame, returned as an M -by- N matrix. M and N are the number of rows and columns in the image.

Dependencies

To enable this port:

- Set the **File name** parameter to the name of a multimedia file that contains video or image data. If the specified file contains both audio and video data, set the **Multimedia outputs** parameter to `Video only` or `Video and audio`.
- Set the **Output color format** parameter to `RGB` and **Image signal** parameter to `Separate color signals`.

Data Types: `single` | `double` | `int8` | `int16` | `int32` | `uint8` | `uint16` | `uint32`

Y — Luma component of image or video frame

matrix

Luma component of the image or video frame, returned as an M -by- N matrix. M and N are the number of rows and columns in the image.

Dependencies

To enable this port:

- Set the **File name** parameter to the name of a multimedia file that contains video or image data. If the specified file contains both audio and video data, set the **Multimedia outputs** parameter to `Video only` or `Video and audio`.
- Set the **Output color format** parameter to `YCbCr 4:2:2`.

Data Types: `single` | `double` | `int8` | `int16` | `int32` | `uint8` | `uint16` | `uint32`

Cb — Blue-difference chrominance component of image or video frame

matrix

Blue-difference chrominance component of the image or video frame, returned as an M -by- $N/2$ matrix. M and N are the number of rows and columns in the input image.

Dependencies

To enable this port:

- Set the **File name** parameter to the name of a multimedia file that contains video or image data. If the specified file contains both audio and video data, set the **Multimedia outputs** parameter to `Video only` or `Video and audio`.
- Set the **Output color format** parameter to `YCbCr 4:2:2`.

Data Types: `single` | `double` | `int8` | `int16` | `int32` | `uint8` | `uint16` | `uint32`

Cr — Red-difference chrominance component of image or video frame

matrix

Red-difference chrominance component of the image or video frame, returned as an M -by- $N/2$ matrix. M and N are the number of rows and columns in each input image.

Dependencies

To enable this port:

- Set the **File name** parameter to the name of a multimedia file that contains video or image data. If the specified file contains both audio and video data, set the **Multimedia outputs** parameter to `Video only` or `Video and audio`.
- Set the **Output color format** parameter to `YCbCr 4:2:2`.

Data Types: `single` | `double` | `int8` | `int16` | `int32` | `uint8` | `uint16` | `uint32`

Audio — Audio signal

`vector` | `matrix`

Audio signal, returned as an M -element vector or an M -by- N matrix. M is the number of samples in each channel and N is the number of channels.

Dependencies

To enable this port, set the **File name** parameter to the name of a multimedia file that contains audio data. If the specified file contains both audio and video data, set the **Multimedia outputs** parameter to `Audio only` or `Video and audio`.

Data Types: `single` | `double` | `int16` | `uint8`

EOF — End-of-file indicator

`scalar`

End-of-file indicator, returned as a logical scalar for each video frame or audio sample. The end-of-file indicator is 1 when the block outputs the final video frame or audio sample from the file, and is 0 otherwise.

Dependencies

To enable this port, select the **Output end-of-file indicator** parameter.

Data Types: `Boolean`

Parameters

Main

File name — Name of multimedia file

`vipmen.avi` (default) | `character vector`

Specify the name of the multimedia file for the block to read. If the file is not located on your MATLAB path, select **Browse** and navigate to the file, or specify the full file path.

On Microsoft® Windows® platforms, this parameter supports URLs that point to Microsoft Media Server (MMS) streams.

Inherit sample time from file — Inherit sample time from file

`on` (default) | `off`

Specify whether the block inherits the sample time from the multimedia file or uses a specified sample time. When you select this parameter, the block inherits the sample time from the input multimedia file.

Tip Select this parameter when you do not know the intended sample rate of the multimedia file.

Desired sample time — Block sample time

1/30 (default) | real positive scalar

Specify a sample time for the block.

Dependencies

To enable this parameter, clear the **Inherit sample time from file** parameter.

Number of times to play file — Number of times to play multimedia file

inf (default) | real positive integer

Specify the number of times to play the input multimedia file. The default value of `inf` specifies that the block repeats playing the multimedia file until the simulation stop time.

Output end-of-file indicator — End-of-file indicator

off (default) | on

Select this parameter to enable the **EOF** port, which indicates whether the output frame or sample is the final video frame or audio sample in the multimedia file.

Multimedia outputs — Type of media

Video only (default) | Audio only | Video and audio

Specify the type of media to read from a file containing both video and audio data.

Dependencies

To enable this parameter, set the **File name** parameter to the name of a multimedia file that contains both audio and video data.

Output color format — Color format of video

RGB (default) | Intensity | YCbCr 4:2:2

Specify the output color format of the input video data. The block supports the RGB, Intensity, and YCbCr 4:2:2 color formats.

Dependencies

To enable this parameter, set the **File name** parameter to the name of a multimedia file that contains video data. If the specified file contains both audio and video data, set the **Multimedia outputs** parameter to `Video only` or `Video and audio`.

Image signal — Output port configuration for RGB video

One multidimensional signal (default) | Separate color signals | Simulink image signal

Specify how the block outputs an RGB color video. If you select `One multidimensional signal`, the block outputs the video data using only the **Image** port. If you select `Separate color`

signals, the block outputs the video data using three separate color channels, divided across the **R**, **G**, and **B** ports. If you select `Simulink image signal`, the block outputs a video in `Simulink.ImageType` datatype.

Dependencies

To enable this parameter:

- Set the **File name** parameter to the name of a multimedia file that contains video data. If the specified file contains both audio and video data, set the **Multimedia outputs** parameter to `Video only` or `Video and audio`.
- Set the **Output color format** parameter to `RGB`.

Read range — Range of audio samples

[1 Inf] (default) | two-element row vector

Specify the range of audio samples to read from the input file as a two-element row vector of the form [StartSample EndSample]. StartSample is the first sample the block reads from the audio file, and EndSample is the final sample the block reads from the audio file. StartSample must be greater than or equal to 1. EndSample must be greater than StartSample.

Dependencies

To enable this parameter, set the **File name** parameter to the name of a multimedia file that contains audio data. If the specified file contains both audio and video data, set the **Multimedia outputs** parameter to `Audio only`.

Samples per audio channel — Samples per audio channel

1024 (default) | real positive integer

Specify the number of samples per audio channel.

Dependencies

To enable this parameter, set the **File name** parameter to the name of a multimedia file that contains audio data. If the specified file contains both audio and video data, set the **Multimedia outputs** parameter to `Audio only`.

Data Types

Video output data type — Video output data type

single (default) | double | int8 | uint8 | int16 | uint16 | int32 | uint32 | Inherit from file

Specify the data type for the output video frames.

Dependencies

To enable this parameter, set the **File name** parameter to the name of a multimedia file that contains video data. If the specified file contains both audio and video data, set the **Multimedia outputs** parameter to `Video only` or `Video and audio`.

Audio output data type — Audio output data type

int16 (default) | double | single | uint8

Specify the data type for the output audio samples.

Dependencies

To enable this parameter, set the **File name** parameter to the name of a multimedia file that contains audio data. If the specified file contains both audio and video data, set the **Multimedia outputs** parameter to `Audio only` or `Video and audio`.

Block Characteristics

Data Types	double integer ^a single
Direct Feedthrough	no
Multidimensional Signals	no
Variable-Size Signals	no
Zero-Crossing Detection	no

a. Supports 16- and 32-bit signed and 8-bit unsigned integers.

More About

Supported Platforms and File Formats

Which supported file formats are available to you depends on the codecs installed on your system.

Platform	Supported File Formats
All Platforms	AVI (.avi) Motion JPEG 2000 (.mj2)
Microsoft Windows	<p>Image: JPEG (.jpg) Bitmap (.bmp)</p> <p>Video: MPEG (.mpeg) MPEG-2 (.mp2) MPEG-1 (.mpg) MPEG-4, including H.264 encoded video (.mp4, .m4v) Windows Media Video (.wmv, .asf, .asx) Any format supported by Microsoft DirectShow® 9.0 or higher.</p> <p>Audio: WAVE (.wav) Windows Media Audio File (.wma) Audio Interchange File Format (.aif, .aiff) Compressed Audio Interchange File Format (.aifc) MP3 (.mp3) Sun Audio (.au) Apple (.snd)</p>
macOS	<p>Video: MPEG-4, including H.264 encoded video (.mp4, .m4v) Apple QuickTime Movie (.mov) Any format supported by QuickTime.</p>

Platform	Supported File Formats
	Audio: Uncompressed AVI (.avi)
Linux®	Any format supported by your installed plug-ins for GStreamer 0.1 or higher, including Ogg Theora (.ogg).

Sample Time Calculations Used for Video and Audio Files

The sample rate that the block uses depends on the audio and video sample rate. While the block operates at a single rate in Simulink, the underlying audio and video streams can produce different rates. In some cases, the block makes a small adjustment to the video rate when the block outputs both audio and video.

Sample time = $\frac{\text{ceil}(\text{AudioSampleRate}/\text{FPS})}{\text{AudioSampleRate}}$. *AudioSampleRate* is the sample rate for audio data, and *FPS* is the video frame rate.

When the audio sample time, $\frac{\text{AudioSampleRate}}{\text{FPS}}$, is not an integer,, the equation cannot reduce to $\frac{1}{\text{FPS}}$.

To prevent synchronization problems, when the audio stream leads the video stream by more than $\frac{1}{\text{FPS}}$, the block drops the corresponding video frame.

In summary, the block outputs one video frame at each Simulink time step. To calculate the number of audio samples to output at each time step, the block divides the audio sample rate by the video frame rate. If the audio sample rate does not divide evenly by the number of video frames per second (FPS), the block rounds the number of audio samples up to the nearest whole number. If necessary, the block periodically drops a video frame to maintain synchronization for large files.

Extended Capabilities

C/C++ Code Generation

Generate C and C++ code using Simulink® Coder™.

Usage notes and limitations:

- Host computer only. Excludes Simulink Desktop Real-Time code generation.
- The executable generated from this block relies on prebuilt dynamic library files (.dll files) included with MATLAB. Use the `packNGo` function to package the code generated from this block and all the relevant files in a compressed ZIP file. Using this ZIP file, you can relocate, unpack, and rebuild your project in another development environment where MATLAB is not installed.

See Also

Blocks

To Multimedia File | Video From Workspace | Video To Workspace | Image From File

Introduced before R2006a

Gamma Correction

Apply or remove gamma correction from images or video streams

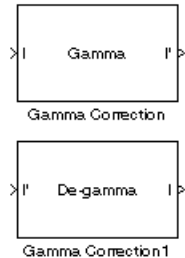

Library

Conversions

visionconversions

Description

Use the Gamma Correction block to apply or remove gamma correction from an image or video stream. For input signals normalized between 0 and 1, the block performs gamma correction as defined by the following equations. For integers and fixed-point data types, these equations are generalized by applying scaling and offset values specific to the data type:

$$S_{LS} = \frac{1}{\frac{\gamma}{B_P^{(\frac{1}{\gamma}-1)}} - \gamma B_P + B_P}$$

$$F_S = \frac{\gamma S_{LS}}{B_P^{(\frac{1}{\gamma}-1)}}$$

$$C_O = F_S B_P^{\frac{1}{\gamma}} - S_{LS} B_P$$

$$I' = \begin{cases} S_{LS} I, & I \leq B_P \\ \frac{1}{F_S} (I' + C_O)^{\gamma}, & I > B_P \end{cases}$$

S_{LS} is the slope of the straight line segment. B_P is the break point of the straight line segment, which corresponds to the **Break point** parameter. F_S is the slope matching factor, which matches the slope of the linear segment to the slope of the power function segment. C_O is the segment offset, which ensures that the linear segment and the power function segments connect. Some of these parameters are illustrated by the following diagram.

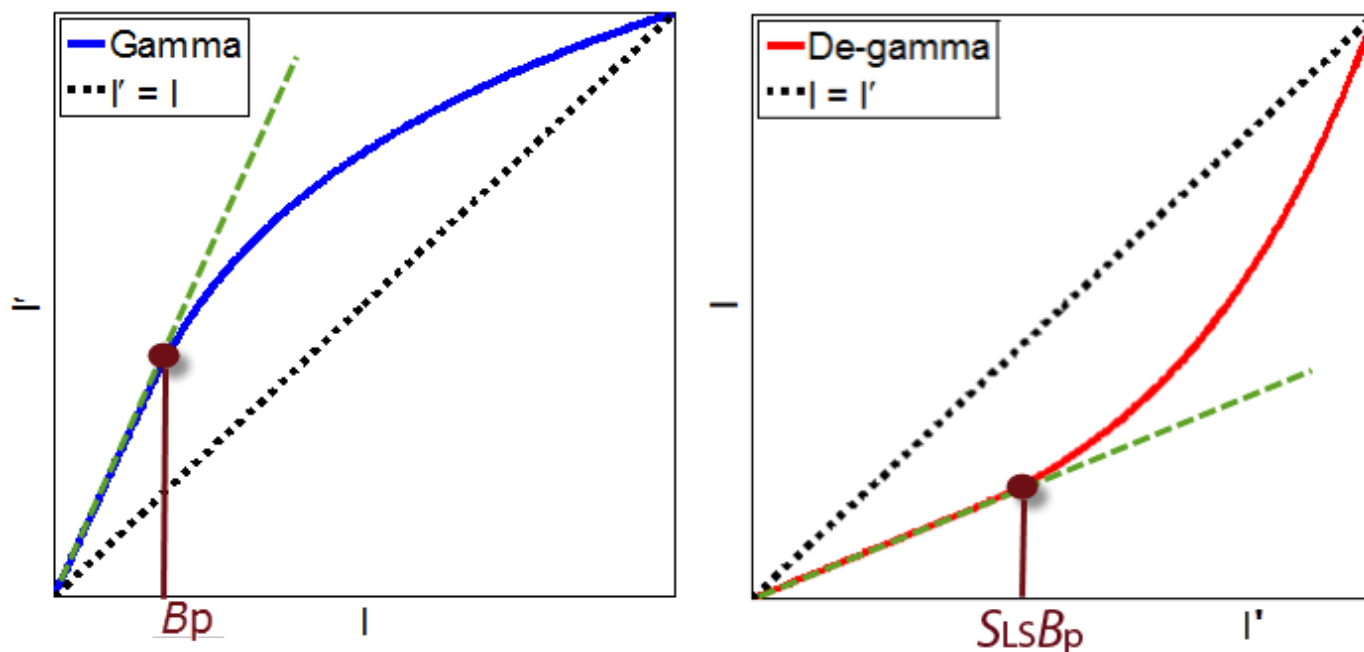

For normalized input signals, the block removes gamma correction, which linearizes the input video stream, as defined by the following equation:

$$I = \begin{cases} \frac{I'}{S_{LS}}, & I' \leq S_{LS}B_p \\ \left(\frac{I' + C_O}{F_S} \right)^\gamma, & I' > S_{LS}B_p \end{cases}$$

Typical gamma values range from 1 to 3. Most monitor gamma values range from 1.8 to 2.2. Check with the manufacturer of your hardware to obtain the exact gamma value. Gamma function parameters for some common standards are shown in the following table:

Standard	Slope	Break Point	Gamma
CIE L*	9.033	0.008856	3
Recommendation ITU-R BT.709-3, Parameter Values for the HDTV Standards for Production and International Programme Exchange	4.5	0.018	20/9
sRGB	12.92	0.00304	

Note This block supports intensity and color images on its ports.

The properties of the input and output ports are summarized in the following table:

Port	Input/Output	Supported Data Types	Complex Values Supported
I	M-by-N matrix of intensity values or an M-by-N-by-P color video signal where P is the number of color planes	<ul style="list-style-type: none"> • Double-precision floating point • Single-precision floating point • Fixed point (up to 16-bit word length) • 8- and 16-bit signed integer • 8- and 16-bit unsigned integer 	No
I'	M-by-N matrix of intensity values or an M-by-N-by-P color video signal where P is the number of color planes	Same as I port	No

Use the **Operation** parameter to specify the block's operation. If you want to perform gamma correction, select Gamma. If you want to linearize the input signal, select De-gamma.

If, for the **Operation** parameter, you select Gamma, use the **Gamma** parameter to enter the desired gamma value of the output video stream. This value must be greater than or equal to 1. If, for the **Operation** parameter, you select De-gamma, use the **Gamma** parameter to enter the gamma value of the input video stream.

Select the **Linear segment** check box if you want the gamma curve to have a linear portion near black. If you select this check box, the **Break point** parameter appears on the dialog box. Enter a scalar value that indicates the *I*-axis value of the end of the linear segment. The break point is shown in the first diagram of this block reference page.

Parameters

Operation

Specify the block's operation. Your choices are Gamma or De-gamma.

Gamma

If, for the **Operation** parameter, you select Gamma, enter the desired gamma value of the output video stream. This value must be greater than or equal to 1. If, for the **Operation** parameter, you select De-gamma, enter the gamma value of the input video stream.

Linear segment

Select this check box if you want the gamma curve to have a linear portion near the origin.

Break point

Enter a scalar value that indicates the *I*-axis value of the end of the linear segment. This parameter is visible if you select the **Linear segment** check box.

References

- [1] Poynton, Charles. *Digital Video and HDTV Algorithms and Interfaces*. San Francisco, CA: Morgan Kaufman Publishers, 2003.

See Also

Color Space Conversion	Computer Vision Toolbox software
imadjust	Image Processing Toolbox software

Extended Capabilities

C/C++ Code Generation

Generate C and C++ code using Simulink® Coder™.

Introduced before R2006a

Gaussian Pyramid

Perform Gaussian pyramid decomposition



Library

Transforms

visiontransforms

Description

The Gaussian Pyramid block computes Gaussian pyramid reduction or expansion to resize an image. The image reduction process involves lowpass filtering and downsampling the image pixels. The image expansion process involves upsampling the image pixels and lowpass filtering. You can also use this block to build a Laplacian pyramid. For more information, see “Examples” on page 1-223.

Note This block supports intensity and color images on its ports.

Port	Output	Supported Data Types	Complex Values Supported
Input	<p>In Reduce mode, the input can be an M-by-N matrix of intensity values or an M-by-N-by-P color video signal where P is the number of color planes.</p> <p>In Expand mode, the input can be a scalar, vector, or M-by-N matrix of intensity values or an M-by-N-by-P color video signal where P is the number of color planes.</p>	<ul style="list-style-type: none"> • Double-precision floating point • Single-precision floating point • Fixed point • 8-, 16-, 32-bit signed integer • 8-, 16-, 32-bit unsigned integer 	No
Output	<p>In Reduce mode, the output can be a scalar, vector, or matrix that represents one level of a Gaussian pyramid.</p> <p>In Expand mode, the output can be a matrix that represents one level of a Gaussian pyramid.</p>	Same as Input port	No

Use the **Operation** parameter to specify whether to reduce or expand the input image. If you select **Reduce**, the block applies a lowpass filter and then downsamples the input image. If you select **Expand**, the block upsamples and then applies a lowpass filter to the input image.

Use the **Pyramid level** parameter to specify the number of times the block upsamples or downsamples each dimension of the image by a factor of 2. For example, suppose you have a 4-by-4 input image. You set the **Operation** parameter to **Reduce** and the **Pyramid level** to 1. The block filters and downsamples the image and outputs a 2-by-2 pixel output image. If you have an M-by-N input image and you set the **Operation** parameter to **Reduce**, you can calculate the dimensions of the output image using the following equation:

$$\text{ceil}\left(\frac{M}{2}\right) - \text{by} - \text{ceil}\left(\frac{N}{2}\right)$$

You must repeat this calculation for each successive pyramid level. If you have an M-by-N input image and you set the **Operation** parameter to **Expand**, you can calculate the dimensions of the output image using the following equation:

$$\left[(M - 1)2^l + 1\right] - \text{by} - \left[(N - 1)2^l + 1\right]$$

In the previous equation, l is the scalar value from 1 to ∞ that you enter for the **Pyramid level** parameter.

Use the **Coefficient source** parameter to specify the coefficients of the lowpass filter. If you select **Default separable filter** $[1/4 - a/2 \ 1/4 \ a \ 1/4 \ 1/4 - a/2]$, use the **a** parameter to define the coefficients in the vector of separable filter coefficients. If you select **Specify via dialog**, use the **Coefficient for separable filter** parameter to enter a vector of separable filter coefficients.

Examples

The following example model shows how to construct a Laplacian pyramid:

- 1 Open this model by typing

`ex_laplacian`

at the MATLAB command prompt.

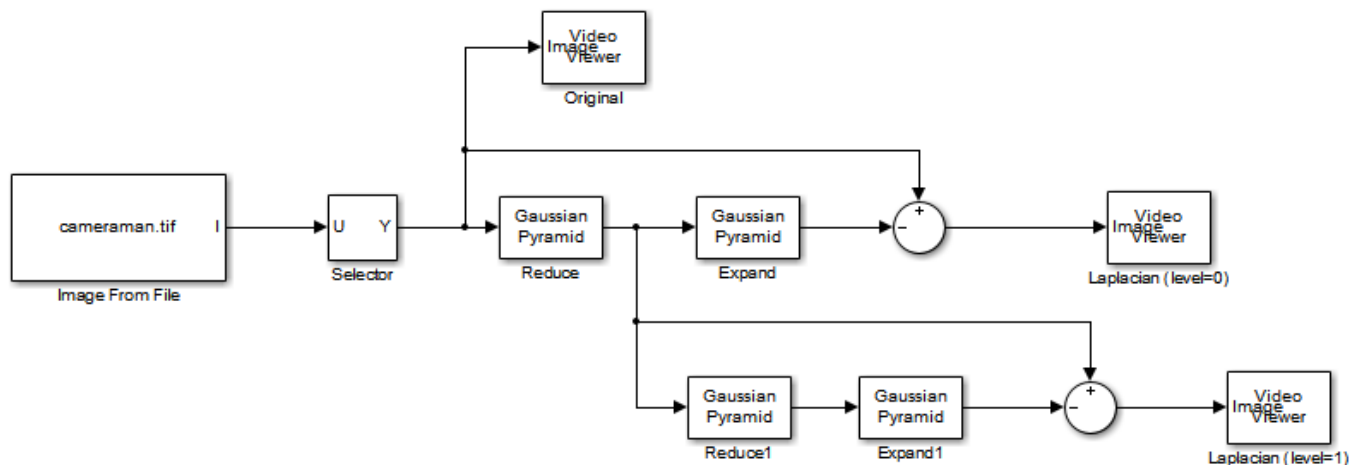

- 2 Run the model to see the following results.

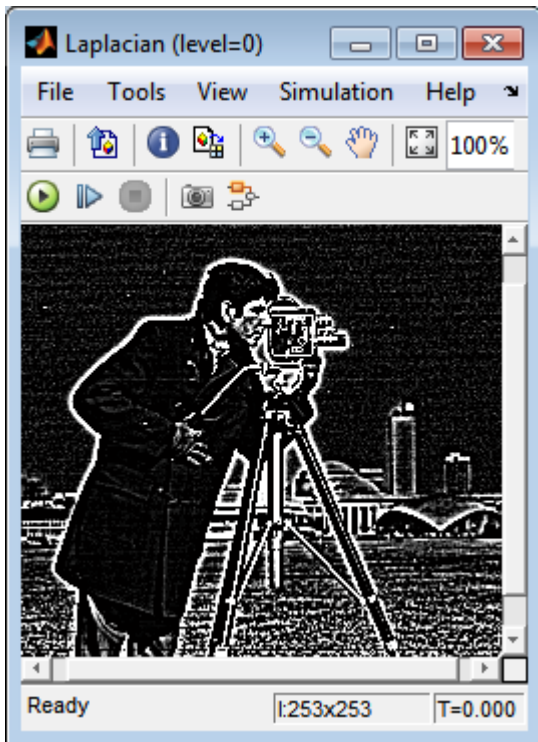

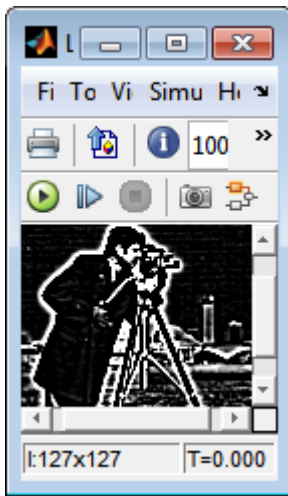

You can construct a Laplacian pyramid if the dimensions of the input image, R-by-C, satisfy $R = M_R 2^N + 1$ and $C = M_C 2^N + 1$, where M_R , M_C , and N are integers. In this example, you have an input matrix that is 256-by-256. If you set M_R and M_C equal to 63 and N equal to 2, you find that the input image needs to be 253-by-253. So you use a Submatrix block to crop the dimensions of the input image to 253-by-253.

Fixed-Point Data Types

The following diagram shows the data types used in the Gaussian Pyramid block for fixed-point signals:

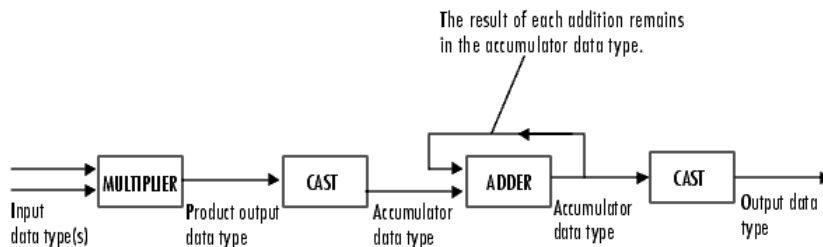

You can set the coefficients table, product output, accumulator, and output data types in the block mask.

Parameters

Operation

Specify whether you want to reduce or expand the input image.

Pyramid level

Specify the number of times the block upsamples or downsamples each dimension of the image by a factor of 2.

Coefficient source

Determine how to specify the coefficients of the lowpass filter. Your choices are **Default separable filter** [1/4-a/2 1/4 a 1/4 1/4-a/2] or **Specify via dialog**.

a

Enter a scalar value that defines the coefficients in the default separable filter [1/4-a/2 1/4 a 1/4 1/4-a/2]. This parameter is visible if, for the **Coefficient source** parameter, you select **Default separable filter** [1/4-a/2 1/4 a 1/4 1/4-a/2].

Coefficients for separable filter

Enter a vector of separable filter coefficients. This parameter is visible if, for the **Coefficient source** parameter, you select **Specify via dialog**.

Rounding mode

Select the rounding mode for fixed-point operations.

Overflow mode

Select the overflow mode for fixed-point operations.

Coefficients

Choose how to specify the word length and the fraction length of the coefficients:

- When you select **Same word length as input**, the word length of the coefficients match that of the input to the block. In this mode, the fraction length of the coefficients is automatically set to the binary-point only scaling that provides you with the best precision possible given the value and word length of the coefficients.
- When you select **Specify word length**, you can enter the word length of the coefficients, in bits. The block automatically sets the fraction length to give you the best precision.
- When you select **Binary point scaling**, you can enter the word length and the fraction length of the coefficients, in bits.
- When you select **Slope and bias scaling**, you can enter the word length, in bits, and the slope of the coefficients. The bias of all signals in the Computer Vision Toolbox blocks is 0.

Product output

As shown in the previous figure, the output of the multiplier is placed into the product output data type and scaling. Use this parameter to specify how to designate the product output word and fraction lengths.

- When you select **Same as input**, these characteristics match those of the input to the block.
- When you select **Binary point scaling**, you can enter the word length and the fraction length of the product output, in bits.
- When you select **Slope and bias scaling**, you can enter the word length, in bits, and the slope of the product output. The bias of all signals in the Computer Vision Toolbox blocks is 0.

Accumulator

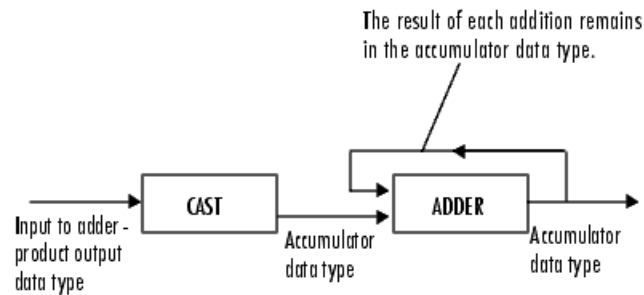

As shown in the previous figure, inputs to the accumulator are cast to the accumulator data type. The output of the adder remains in the accumulator data type as each element of the input is added to it. Use this parameter to specify how to designate the accumulator word and fraction lengths.

- When you select **Same as product output**, these characteristics match those of the product output.
- When you select **Same as input**, these characteristics match those of the input to the block.
- When you select **Binary point scaling**, you can enter the word length and the fraction length of the accumulator, in bits.
- When you select **Slope and bias scaling**, you can enter the word length, in bits, and the slope of the accumulator. The bias of all signals in the Computer Vision Toolbox blocks is 0.

Output

Choose how to specify the word length and fraction length of the output of the block:

- When you select **Same as input**, these characteristics match those of the input to the block.
- When you select **Binary point scaling**, you can enter the word length and the fraction length of the output, in bits.
- When you select **Slope and bias scaling**, you can enter the word length, in bits, and the slope of the output. The bias of all signals in the Computer Vision Toolbox blocks is 0.

Lock data type settings against change by the fixed-point tools

Select this parameter to prevent the fixed-point tools from overriding the data types you specify on the block mask. For more information, see `fxptdlg`, a reference page on the Fixed-Point Tool in the Simulink documentation.

See Also

Resize	Computer Vision Toolbox software
--------	----------------------------------

Extended Capabilities

C/C++ Code Generation

Generate C and C++ code using Simulink® Coder™.

Introduced before R2006a

Histogram Equalization

Enhance contrast of images using histogram equalization

Library: Computer Vision Toolbox / Analysis & Enhancement

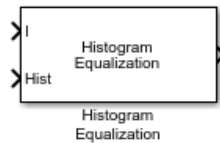

Description

The Histogram Equalization block enhances the contrast of images. The block transforms the intensity values in an image so that the histogram of the output image approximately matches a specified histogram. By default, the block transforms the input image so that the histogram of the output image is nearly flat.

Ports

Input

I — Input image

matrix

Input image, specified as a matrix of intensity values.

Data Types: `single` | `double` | `int8` | `int16` | `int32` | `uint8` | `uint16` | `uint32` | `fixed point`

Hist — Target histogram

vector of integers

Target histogram for the output image, specified as a vector of integers. Each element of the vector represents the desired count value for the corresponding bin. You must normalize the input vector such that the sum of all the bin counts equals the number of pixels in the input image.

When the data type of the input image is `single` or `double`, the **Hist** port input must be the same data type.

Dependencies

To enable this port, set these block parameters:

- **Target histogram:** User-defined
- **Histogram source:** Input port

Data Types: `single` | `double` | `int8` | `int16` | `int32` | `uint8` | `uint16` | `uint32`

Output

Port_1 — Output image

matrix

Output image, returned as a matrix of intensity values. The data type of the output image is the same as the data type of the input image.

Data Types: `single` | `double` | `int8` | `int16` | `int32` | `uint8` | `uint16` | `uint32` | `fixed point`

Parameters

Target histogram — Type of desired histogram

`Uniform` (default) | `User-defined`

Specify the desired histogram type.

- `Uniform` — The block transforms the input image so that the histogram of the output image is approximately flat.
- `User-defined` — The block transforms the input image so that the histogram of the output image approximately matches the specified histogram.

Number of bins — Number of bins of target histogram

`64` (default) | `integer greater than one`

Specify the number of bins for the target histogram. The block spaces the bins equally.

Dependencies

To enable this parameter, set the **Target histogram** parameter to `Uniform`.

Histogram source — Source of target histogram

`Specify via dialog` (default) | `Input port`

Specify the source of the target histogram as either `Specify via dialog` or `Input port`.

- `Specify via dialog` — Use the **Histogram** parameter to specify a vector of integer values representing the desired counts of the equally spaced bins of the target histogram.
- `Input port` — Use the **Hist** input port to specify the target histogram.

Dependencies

To enable this parameter, set the **Target histogram** parameter to `User-defined`.

Note Normalize the input vector, specified using the selected **Histogram source**, such that the sum of all the bin counts equals the number of pixels in the input image. The block does not display an error if you do not normalize the vector.

Histogram — Bin counts of target histogram

`ones(1, 64)` (default) | `vector of integers`

Specify the count for each bin of the target histogram. The sum of the bin counts must equal the number of pixels in the input image.

Dependencies

To enable this parameter, set these block parameters:

- **Target histogram:** User-defined
- **Histogram source:** Specify via dialog

Block Characteristics

Data Types	double fixed point integer single
Multidimensional Signals	no
Variable-Size Signals	no

References

- [1] Gonzalez, Rafael C., and Richard E. Woods. *Digital Image Processing: International Edition*. 3rd ed. Upper Saddle River, NJ: Pearson, 2008.

Extended Capabilities

C/C++ Code Generation

Generate C and C++ code using Simulink® Coder™.

See Also

Blocks

Contrast Adjustment

Functions

histeq | imadjust

Introduced before R2006a

Hough Lines

Find Cartesian coordinates of lines described by rho and theta pairs

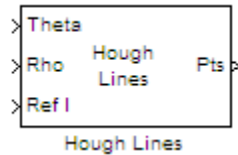

Library

Transforms

S

Description

The Hough Lines block finds the points of intersection between the reference image boundary lines and the line specified by a (rho, theta) pair. The block outputs one-based [x y] coordinates for the points of intersection. The boundary lines indicate the left and right vertical boundaries and the top and bottom horizontal boundaries of the reference image.

If the line specified by the (rho, theta) pair does not intersect two border lines in the reference image, the block outputs the values, $[(0, 0), (0, 0)]$. This output intersection value allows the next block in your model to ignore the points. Generally, the Hough Lines block precedes a block that draws a point or shape at the intersection.

The following figure shows the input and output coordinates for the Hough Lines block.

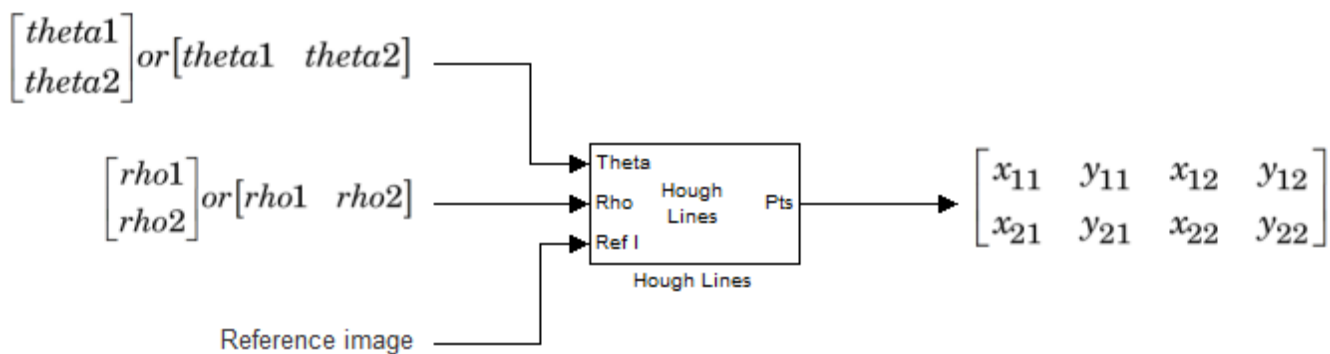

Port Description

Port	Input/Output	Supported Data Types	Complex Values Supported
Theta	Vector of theta values that represent input lines	<ul style="list-style-type: none"> • Double-precision floating point • Single-precision floating point • Fixed point (signed, word length less than or equal to 32) • 8-, 16-, and 32-bit signed integer 	No
Rho	Vector of rho values that represent input lines	Same as Theta port	No
Ref I	Matrix that represents a binary or intensity image or matrix that represents one plane of an RGB image	<ul style="list-style-type: none"> • Double-precision floating point • Single-precision floating point • Fixed-point (signed and unsigned) • Custom data types • Boolean • 8-, 16-, and 32-bit signed integer • 8-, 16-, and 32-bit unsigned integer 	No
Pts	M -by-4 matrix of intersection values, where M is the number of input lines	<ul style="list-style-type: none"> • 32-bit signed integer 	No

Parameters

Sine value computation method

If you select **Trigonometric function**, the block computes sine and cosine values to calculate the intersections of the lines during the simulation. If you select **Table lookup**, the block computes and stores the trigonometric values to calculate the intersections of the lines before the simulation starts. In this case, the block requires extra memory.

For floating-point inputs, set the **Sine value computation method** parameter to **Trigonometric function**. For fixed-point inputs, set the parameter to **Table lookup**.

Theta resolution (radians)

Use this parameter to specify the spacing of the theta-axis. This parameter appears in the dialog box only if, for the **Sine value computation method** parameter, you select **Table lookup**. parameter appears in the dialog box.

Rounding mode

Select the rounding mode for fixed-point operations.

Overflow mode

Select the overflow mode for fixed-point operations.

Sine table

Choose how to specify the word length of the values of the sine table. The fraction length of the sine table values always equals the word length minus one:

When you select **Specify word length**, you can enter the word length of the sine table.

The sine table values do not obey the **Rounding mode** and **Overflow mode** parameters; they saturate and round to Nearest.

Product output

Use this parameter to specify how to designate this product output word and fraction lengths:

When you select `Same as first input`, the characteristics match the characteristics of the first input to the block.

When you select `Binary point scaling`, you can enter the word length and the fraction length of the product output, in bits.

When you select `Slope and bias scaling`, you can enter the word length, in bits, and the slope of the product output. All signals in the Computer Vision Toolbox blocks have a bias of 0.

See “Multiplication Data Types” for illustrations depicting the use of the product output.

Accumulator

Use this parameter to specify how you would like to designate the accumulator word and fraction lengths.

When you select `Same as product output` the characteristics match the characteristics of the product output.

When you select `Binary point scaling`, you can enter the **Word length** and the **Fraction length** of the accumulator, in bits.

When you select `Slope and bias scaling`, you can enter the **Word length**, in bits, and the **Slope** of the **Accumulator**. All signals in the Computer Vision Toolbox software have a bias of 0.

See “Multiplication Data Types” for illustrations depicting the use of the accumulator data type in this block.

Lock data type settings against change by the fixed-point tools

Select this parameter to prevent the fixed-point tools from overriding the data types you specify on the block mask. For more information, see `fxptdlg`, a reference page on the Fixed-Point Tool in the Simulink documentation.

Examples

The following figure shows Line 1 intersecting the boundaries of the reference image at $[(x_{11}, y_{11}) (x_{12}, y_{12})]$ and Line 2 intersecting the boundaries at $[(x_{21}, y_{21}) (x_{22}, y_{22})]$

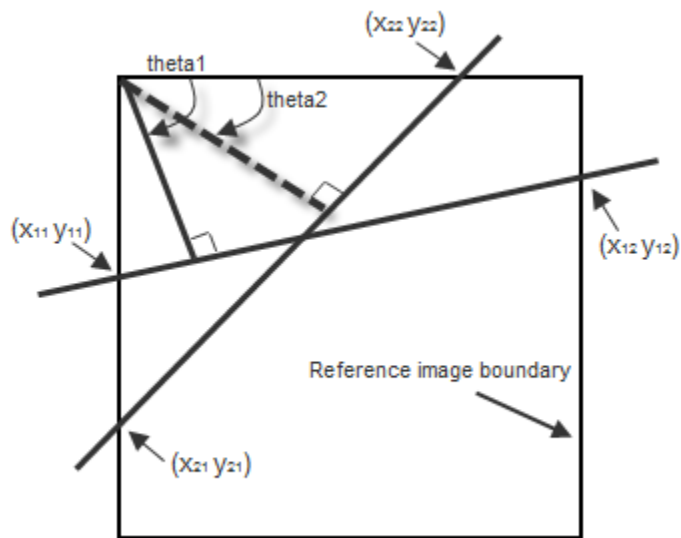

See Also

Find Local Maxima	Computer Vision Toolbox
Hough Transform	Computer Vision Toolbox

Extended Capabilities

C/C++ Code Generation

Generate C and C++ code using Simulink® Coder™.

Introduced before R2006a

Hough Transform

Find lines in images

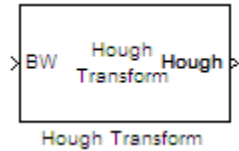

Library

Transforms

visiontransforms

Description

Use the Hough Transform block to find straight lines in an image. The block outputs the Hough space matrix and, optionally, the *rho*-axis and *theta*-axis vectors. Peak values in the matrix represent potential straight lines in the input image. Generally, the Hough Transform block precedes the Hough Lines block which uses the output of this block to find straight lines in an image. You can instead use a custom algorithm to locate peaks in the Hough space matrix in order to identify potential straight lines.

Port	Input/Output	Supported Data Types	Supported Complex Values
BW	Matrix that represents a binary image	Boolean	No
Hough	Parameter space matrix	<ul style="list-style-type: none"> • Double-precision floating point • Single-precision floating point • Fixed point (unsigned, fraction length equal to 0) • 8-, 16-, 32-bit unsigned integer 	No
Theta	Vector of theta values	<ul style="list-style-type: none"> • Double-precision floating point • Single-precision floating point • Fixed point (signed) • 8-, 16-, 32-bit signed integer 	No
Rho	Vector of rho values	Same as Theta port	No

Parameters

Theta resolution (radians)

Specify the spacing of the Hough transform bins along the *theta*-axis.

Rho resolution (pixels)

Specify the spacing of the Hough transform bins along the *rho*-axis.

Output theta and rho values

If you select this check box, the **Theta** and **Rho** ports appear on the block. The block outputs theta and rho-axis vector values at these ports.

Output data type

Specify the data type of your output signal.

Rounding mode

Select the rounding mode for fixed-point operations.

Overflow mode

Select the overflow mode for fixed-point operations.

Sine table

Choose how to specify the word length of the values of the sine table:

- When you select **Binary point scaling**, you can enter the word length of the sine table values, in bits.
- When you select **Slope and bias scaling**, you can enter the word length of the sine table values, in bits.

The sine table values do not obey the **Rounding mode** and **Overflow mode** parameters; they always saturate and round to **Nearest**.

Rho

Choose how to specify the word length and the fraction length of the rho values:

- When you select **Binary point scaling**, you can enter the word length and the fraction length of the rho values, in bits.
- When you select **Slope and bias scaling**, you can enter the word length, in bits, and the slope of the rho values. All signals in Computer Vision Toolbox blocks have a bias of 0.

Product output

. Use this parameter to specify how to designate the product output word and fraction lengths:

- When you select **Binary point scaling**, you can enter the word length and the fraction length of the product output, in bits.
- When you select **Slope and bias scaling**, you can enter the word length, in bits, and the slope of the product output. All signals in Computer Vision Toolbox blocks have a bias of 0.

See “Multiplication Data Types” for illustrations depicting the use of the product output.

Accumulator

Use this parameter to specify how to designate this accumulator word and fraction lengths:

- When you select **Same as product output**, these characteristics match the characteristics of the product output.
- When you select **Binary point scaling**, you can enter the word length and the fraction length of the accumulator, in bits.
- When you select **Slope and bias scaling**, you can enter the word length, in bits, and the slope of the accumulator. All signals in Computer Vision Toolbox blocks have a bias of 0.

See “Multiplication Data Types” for illustrations depicting the use of the accumulator data type in this block.

Lock data type settings against change by the fixed-point tools

Select this parameter to prevent the fixed-point tools from overriding the data types you specify on the block mask. For more information, see `fxptdlg`, a reference page on the Fixed-Point Tool in the Simulink documentation.

Hough output

Choose how to specify the word length and fraction length of the Hough output of the block:

- When you select **Binary point scaling**, you can enter the word length of the Hough output, in bits. The fraction length always has a value of 0.
- When you select **Slope and bias scaling**, you can enter the word length, in bits, of the Hough output. The slope always has a value of 0. All signals in Computer Vision Toolbox blocks have a bias of 0.

Theta output

Choose how to specify the word length and fraction length of the theta output of the block:

- When you select **Binary point scaling**, you can enter the word length and the fraction length of the theta output, in bits.
- When you select **Slope and bias scaling**, you can enter the word length, in bits, and the slope of the theta output. All signals in Computer Vision Toolbox blocks have a bias of 0.

Algorithm

The Hough Transform block implements the Standard Hough Transform (SHT). The SHT uses the parametric representation of a line:

$$rho = x * \cos(theta) + y * \sin(theta)$$

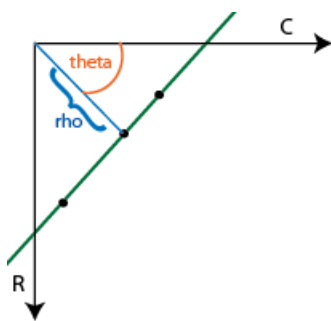

The upper-left corner pixel is assumed to be at $x=0,y=0$.

The variable *rho* indicates the perpendicular distance from the origin to the line.

The variable *theta* indicates the angle of inclination of the normal line from the x-axis. The range of *theta* is $-\frac{\pi}{2} \leq \theta < +\frac{\pi}{2}$ with a step-size determined by the **Theta resolution (radians)** parameter. The SHT measures the angle of the line clockwise with respect to the positive x-axis.

The Hough Transform block creates an accumulator matrix. The $(rho, theta)$ pair represent the location of a cell in the accumulator matrix. Every valid (logical true) pixel of the input binary image represented by (R,C) produces a rho value for all theta values. The block quantizes the rho values to the nearest number in the rho vector. The rho vector depends on the size of the input image and the user-specified rho resolution. The block increments a counter (initially set to zero) in those accumulator array cells represented by $(rho, theta)$ pairs found for each pixel. This process validates the point (R,C) to be on the line defined by $(rho, theta)$. The block repeats this process for each logical true pixel in the image. The **Hough** block outputs the resulting accumulator matrix.

See Also

Find Local Maxima	Computer Vision Toolbox
Hough Lines	Computer Vision Toolbox
hough	Image Processing Toolbox
houghlines	Image Processing Toolbox
houghpeaks	Image Processing Toolbox

Extended Capabilities

C/C++ Code Generation

Generate C and C++ code using Simulink® Coder™.

See Also

Topics

“Detect and Track Face”

“Rotation Correction”

Introduced before R2006a

Image Complement

Compute complement of pixel values in binary or intensity images



Library

Conversions

visionconversions

Description

The Image Complement block computes the complement of a binary or intensity image. For binary images, the block replaces pixel values equal to 0 with 1 and pixel values equal to 1 with 0. For an intensity image, the block subtracts each pixel value from the maximum value that can be represented by the input data type and outputs the difference.

For example, suppose the input pixel values are given by $x(i)$ and the output pixel values are given by $y(i)$. If the data type of the input is double or single precision floating-point, the block outputs $y(i) = 1.0 - x(i)$. If the input is an 8-bit unsigned integer, the block outputs $y(i) = 255 - x(i)$.

Port	Input/Output	Supported Data Types	Complex Values Supported
Input	Vector or matrix of intensity values	<ul style="list-style-type: none"> • Double-precision floating point • Single-precision floating point • Boolean • 8-, 16-, 32-bit signed integer • 8-, 16-, 32-bit unsigned integer 	No
Output	Complement of a binary or intensity	Same as Input port	No

The dimensions, data type, complexity, and frame status of the input and output signals are the same.

See Also

Autothreshold	Computer Vision Toolbox software
Chroma Resampling	Computer Vision Toolbox software
Color Space Conversion	Computer Vision Toolbox software

Extended Capabilities

C/C++ Code Generation

Generate C and C++ code using Simulink® Coder™.

Introduced before R2006a

Image Data Type Conversion

Convert and scale input image to specified output data type



Library

Conversions

visionconversions

Description

The Image Data Type Conversion block changes the data type of the input to the user-specified data type and scales the values to the new data type's dynamic range. To convert between data types without scaling, use the Simulink Data Type Conversion block.

When converting between floating-point data types, the block casts the input into the output data type and clips values outside the range to 0 or 1. When converting to the Boolean data type, the block maps 0 values to 0 and all other values to one. When converting to or between all other data types, the block casts the input into the output data type and scales the data type values into the dynamic range of the output data type. For double- and single-precision floating-point data types, the dynamic range is between 0 and 1. For fixed-point data types, the dynamic range is between the minimum and maximum values that can be represented by the data type.

Note This block supports intensity and color images on its ports.

Port	Input/Output	Supported Data Types	Complex Values Supported
Input	M-by-N matrix of intensity values or an M-by-N-by-P color video signal where P is the number of color planes	<ul style="list-style-type: none"> • Double-precision floating point • Single-precision floating point • Fixed point (word length less than or equal to 16) • Boolean • 8-, 16-bit signed integer • 8-, 16-bit unsigned integer 	No
Output	M-by-N matrix of intensity values or an M-by-N-by-P color video signal where P is the number of color planes	Same as Input port	No

The dimensions, complexity, and frame status of the input and output signals are the same.

Use the **Output data type** parameter to specify the data type of your output signal values.

Parameters

Output data type

Use this parameter to specify the data type of your output signal.

Signed

Select this check box if you want the output fixed-point data to be signed. This parameter is visible if, for the **Output data type** parameter, you choose Fixed-point.

Word length

Use this parameter to specify the word length of your fixed-point output. This parameter is visible if, for the **Output data type** parameter, you choose Fixed-point.

Fraction length

Use this parameter to specify the fraction length of your fixed-point output. This parameter is visible if, for the **Output data type** parameter, you choose Fixed-point.

See Also

Autothreshold	Computer Vision Toolbox software
---------------	----------------------------------

Extended Capabilities

C/C++ Code Generation

Generate C and C++ code using Simulink® Coder™.

Introduced before R2006a

Image To Matrix

Converts Simulink image data to matrix data

Library: Computer Vision Toolbox OpenCV Interface for Simulink



Description

The Image To Matrix block converts Simulink image data to matrix data.

Ports

Input

Port_1 — Input signal

`Simulink.ImageType`

Input signal to the Image To Matrix block. The input is a Simulink image data type.

Data Types: `Simulink.ImageType`

Output

Port_1 — Output signal

`matrix`

Output signal from the Image To Matrix block. The output is a matrix or an array, depending on the format of the input.

- *M*-by-*N* matrix — The input is a Grayscale image. *M* and *N* are the height and width of the image, in pixels.
- *M*-by-*N*-by-*C* matrix — The input is an RGB or BGR image. *M* and *N* are the height and width of the image, in pixels. *C* is the number of color channels.

Data Types: `uint8` | `uint16` | `int8` | `int16` | `single` | `double`

Parameters

Rows — Number of rows in image data

'480' (default) | positive integer

Specify the number of rows in the image data as a positive integer.

Programmatic Use

Block Parameter: Rows

Type: double

Value: positive integer

Default: '480'

Columns — Number of columns in image data

'640' (default) | positive integer

Specify the number of columns in the image data as a positive integer.

Programmatic Use**Block Parameter:** Columns**Type:** double**Value:** positive integer**Default:** '640'**Channels — Number of color channels or samples for each pixel**

3 (default) | 1

Specify the number of color channels or samples for each pixel in the array as 1 or 3. The number of channels must correspond to the number of color channels in the color format of the image data. These are the values of **Channels** for the supported color formats:

Color Format	Channels
Grayscale	1
RGB	3
BGR	3

Programmatic Use**Block Parameter:** Channels**Type:** double**Value:** positive integer**Default:** '3'**Block Characteristics**

Data Types	double single uint8 uint16 int8 int16 int32 image
Direct Feedthrough	Yes
Multidimensional Signals	Yes
Variable-Size Signals	No

Extended Capabilities**C/C++ Code Generation**

Generate C and C++ code using Simulink® Coder™.

Supports C++ code generation.

See Also

Matrix To Image

Topics

"Install and Use Computer Vision Toolbox Interface for OpenCV in Simulink"

Introduced in R2021b

Image From File

Read image from file location

Library: Computer Vision Toolbox / Sources



Description

The Image From File block reads an image from a specified file location and imports it to the Simulink workspace. The input file can contain a binary image, grayscale image, or color image.

Ports

Output

Image — Output image

matrix | 3-D array

Output image, returned as a matrix or 3-D array. If the image read is a binary or grayscale image, the output is an M -by- N matrix. If the image read is a color image, the output is an M -by- N -by-3 array.

Dependencies

To enable this port, set the **Image signal** parameter to `One multidimensional signal`.

Data Types: `single` | `double` | `int8` | `int16` | `int32` | `uint8` | `uint16` | `uint32` | `Boolean` | `fixed point`

R — Red color component of image

matrix

Red color component of the image, returned as an M -by- N matrix. The block returns this output if the input is a color image. If the **Image signal** parameter is set to `Separate color signals` and the input image is grayscale, the block returns only this port.

Dependencies

To enable this port, set the **Image signal** parameter to `Separate color signals`.

Data Types: `single` | `double` | `int8` | `int16` | `int32` | `uint8` | `uint16` | `uint32` | `Boolean` | `fixed point`

G — Green color component of image

matrix

Green color component of the image, returned as an M -by- N matrix. The block returns this output only if the input is a color image.

Dependencies

To enable this port, set the **Image signal** parameter to `Separate color signals`.

Data Types: `single` | `double` | `int8` | `int16` | `int32` | `uint8` | `uint16` | `uint32` | `Boolean` | `fixed point`

B — Blue color component of image

`matrix`

Blue color component of the image, returned as an M -by- N matrix. The block returns this output only if the input is a color image.

Dependencies

To enable this port, set the **Image signal** parameter to `Separate color signals`.

Data Types: `single` | `double` | `int8` | `int16` | `int32` | `uint8` | `uint16` | `uint32` | `Boolean` | `fixed point`

Parameters**File Name — Input image**

`peppers.png` (default) | file name

Specify the name of the file that contains the image to read. If the file is not on the MATLAB path, click **Browse** and navigate to the file. For the list of supported file formats, see the `imread` function reference page in the MATLAB documentation.

Note The **File Name** parameter supports URL paths.

Sample time — Sample time for block execution

`inf` (default) | `Positive scalar` | `Vector`

Specify the sample time for block execution. Vector length must be 2 which represents [Period, Offset] values where offset should be less than period and non-negative. Given the default value of `inf`, the block outputs a matrix for grayscale and binary. For an input grayscale or color image, the output is a 3-D or 4-D array, respectively.

The value of the added dimension is equal to $\text{floor}((T_{sim}/T_s)+1)$.

T_{sim} is the simulation time and T_s is the sample time, for block execution. For example, if the input image is a 256-by-256 matrix, the simulation time is 10 sec, and the sample time is set to 0.5 sec, then the output is a 256-by-256-by-21 array.

Image signal — Signal returned by block

`One multidimensional signal` (default) | `Separate color signals`

Specify how the block returns the image read from the file.

- `One multidimensional signal`— The block has one output port, which returns the entire image.
- `Separate color signals` — The block has three output ports, one for each color channel, which returns the individual color channels of the image.

Output port labels — Output port labels

R|G|B (default) | port names

Specify the labels for the output ports. Each label can be any value. Use vertical bar character, |, as a delimiter between the names of all the output ports.

Dependencies

To enable this parameter, set the **Image signal** parameter to `Separate color signals`.

Data type**Output data type — Data type of output image**

Inherit from input image (default) | double | single | int8 | uint8 | int16 | uint16 | int32 | uint32 | boolean | Fixed-point | User-defined | Inherit via back propagation

Specify the data type of the output image. If the input image data type differs from the selected value of the **Output data type** parameter, the block scales the pixel values, adds an offset to the pixel values so that they are in the dynamic range of the new data type, or both. Double- and single-precision floating-point pixel values must be in the range [0 1].

Signed — Signed fixed-point data type

on (default) | off

Select this parameter if the input image data type is signed fixed-point.

Dependencies

To enable this parameter, set the **Output data type** parameter to `Fixed-point`.

Word length — Bits in fixed-point data type

16 (default) | positive scalar

Specify the word length, in bits, of the fixed-point output data type. The value should be less than 32.

Dependencies

To enable this parameter, set the **Output data type** parameter to `Fixed-point`.

Set fraction length in output to — Scaling factor of fixed-point data type

User-defined (default) | Best precision

Specify the scaling factor of the fixed-point output as one of these options.

- **Best precision**— The output scales automatically such that the output signal has the best possible precision.
- **Choose User-defined**— Specify the output scaling in the **Fraction length** parameter.

Dependencies

To enable this parameter, set the **Output data type** parameter to `Fixed-point`.

Fractional length — Fractional bits

15 (default) | scalar

Specify the number of bits to the right of the decimal point.

Dependencies

To enable this port, set the **Output data type** parameter to Fixed-point, and set the **Set fraction length in output** parameter to User-defined.

User-defined data type — User-defined fixed-point data type

`uint(8)` (default) | User-defined fixed-point data type

Specify any built-in or fixed-point data type. You can specify the below fixed-point data types using the Fixed-Point Designer™ library.

- `sfix`
- `ufix`
- `sint`
- `uint`
- `sfrac`
- `ufrac`

Dependencies

To enable this parameter, set the **Output data type** parameter to User-defined.

Block Characteristics

Data Types	Boolean double fixed point integer single
Multidimensional Signals	no
Variable-Size Signals	no

Extended Capabilities**C/C++ Code Generation**

Generate C and C++ code using Simulink® Coder™.

See Also**Blocks**

From Multimedia File | Image From Workspace | To Video Display | Video From Workspace | Video Viewer

Functions

`im2double` | `im2uint8` | `imread`

Introduced before R2006a

Image From Workspace

Import image from MATLAB workspace

Library: Computer Vision Toolbox / Sources



Description

The Image From Workspace block imports an image from a matrix, 3-D array, MATLAB function, or variable stored in the MATLAB workspace, to the Simulink workspace.

Ports

Output

Image — Output image

matrix | 3-D array

Output image, returned as a matrix or 3-D array. If the imported image is binary or grayscale image, the output is a matrix of size M -by- N . If the imported image is a color image, the output is a 3-D array of size M -by- N -by-3.

Dependencies

To enable this port, set the **Image signal** parameter to `One multidimensional signal`.

Data Types: `single` | `double` | `int8` | `int16` | `int32` | `uint8` | `uint16` | `uint32` | `Boolean` | `fixed point`

R — Red color component of image

matrix

Red color component of the image, returned as an M -by- N matrix. The block returns this output if the input is a color image. If the **Image signal** parameter is set to `Separate color signals` and the input image is binary or grayscale, the block returns only this port

Dependencies

To enable this port, set the **Image signal** parameter to `Separate color signals`.

Data Types: `single` | `double` | `int8` | `int16` | `int32` | `uint8` | `uint16` | `uint32` | `Boolean` | `fixed point`

G — Green color component of image

matrix

Green color component of the image, returned as an M -by- N matrix. The block returns this output only if the input is a color image.

Dependencies

To enable this port, set the **Image signal** parameter to `Separate color signals`.

Data Types: `single` | `double` | `int8` | `int16` | `int32` | `uint8` | `uint16` | `uint32` | `Boolean` | `fixed point`

B — Blue color component of image

`matrix`

Blue color component of the image, returned as an M -by- N matrix. The block returns this output only if the input is a color image.

Dependencies

To enable this port, set the **Image signal** parameter to `Separate color signals`.

Data Types: `single` | `double` | `int8` | `int16` | `int32` | `uint8` | `uint16` | `uint32` | `Boolean` | `fixed point`

Parameters**Main****Value — Image to be imported**

`checker_board(10)` (default) | `vector` | `matrix` | `3-D array` | `MATLAB workspace variable` | `MATLAB function`

Specify the image as a vector, matrix, 3-D array, function, or MATLAB workspace variable. The value parameter can be:

- **Vector** — The value given to the **Value** parameter can be a row vector or column vector
- **3-D numeric array** — The value given to the **Value** parameter can be 3-D array, which is generated using MATLAB functions
- **MATLAB workspace variable** — The value given to the **Value** parameter can be a variable name, which is MATLAB workspace variable
- **MATLAB function** — The value given to the **Value** parameter can be a MATLAB function with specified input arguments to generate a numeric array

Sample time — Sample time for block execution

`inf` (default) | `positive scalar` | `Vector`

This parameter specifies the sample time for block execution. Vector length must be 2 which represents [Period, Offset] values where offset should be less than period and non-negative. Given the default value of `inf`, the block outputs a matrix for grayscale and binary. The output is 3-D or 4-D, if the input image is a gray scale or color image respectively.

The value of the added dimension is equal to $\text{floor}((T_{sim}/T_s)+1)$

T_{sim} is the simulation time and T_s is the sample time, for block execution. For example, if the input image is a 256-by-256 matrix, the simulation time is 10 sec and the sample time is set to 0.5 sec, then the output is a 256-by-256-by-21 array.

Image signal — Signal returned by block

`One multidimensional signal` (default) | `Separate color signals`

Specify how the block returns the image read from the MATLAB workspace.

- **One multidimensional signal**— The block has one output port, **Image**, that returns the entire image.
- **Separate color signals** — The block has an output port for each color channel. Each port returns a single color channel of the image.

Output port labels — Output port labels

R|G|B (default) | port names

Specify labels for the output ports. Each label can be any value. Use the vertical bar character, |, as a delimiter to name all the output ports.

Dependencies

To enable this parameter, set the **Image signal** parameter to **Separate color signals**.

Data type

Output data type — Data type of the output image

Inherit from Value (default) | double | single | int8 | uint8 | int16 | uint16 | int32 | uint32 | boolean | Fixed-point | User-defined | Inherit via back propagation | ...

Specify the data type of the output image. If the data type of the imported image, specified in the **Value** parameter, differs from the value of the **Output data type** parameter, the block scales the pixel values, adds an offset to the pixel values so that they are in the dynamic range of the new data type, or does both. Double- and single-precision floating-point pixel values must be in the range of [0, 1].

Signed — Signed fixed-point data type

on (default) | off

Select this parameter if the input image data type is signed fixed-point.

Dependencies

To enable this parameter, set the **Output data type** parameter to **Fixed-point**.

Word length — Bits in fixed-point data type

16 (default) | positive scalar

Specify the word length, in bits, of the fixed-point output data type. The value should be less than 32.

Dependencies

To enable this parameter, set the **Output data type** parameter to **Fixed-point**.

Set fraction length in output to — Scaling factor of the fixed-point

User-defined (default) | Best precision

Specify the scaling factor of the fixed-point output by either of the following two methods:

- **Best precision**— The output scaling automatically such that the output signal has the best possible precision.
- **User-defined** — The the output scaling in the **Fraction length** parameter.

Dependencies

To enable this parameter, set the **Output data type** parameter to Fixed-point.

Fractional length — Fractional bits

15 (default) | scalar

Specify the number of bits to the right of the decimal point.

Dependencies

To enable this parameter, set the **Output data type** parameter to Fixed-point, and set the **Set fraction length in output** parameter to User-defined.

User-defined data type — User-defined fixed-point data type

sfix(16) (default) | user-defined fixed-point data type

Specify any built-in or fixed-point data type. You can specify the below fixed-point data types using the Fixed-Point Designer library.

- sfix
- ufix
- sint
- uint
- sfrac
- ufrac

Dependencies

To enable this parameter, set the **Output data type** parameter to User-defined.

Block Characteristics

Data Types	Boolean double fixed point integer single
Multidimensional Signals	no
Variable-Size Signals	no

Extended Capabilities**C/C++ Code Generation**

Generate C and C++ code using Simulink® Coder™.

See Also**Blocks**

From Multimedia File | To Video Display | Video From Workspace | Video Viewer

Functions

im2double | im2uint8

Introduced before R2006a

Image Pad

Pad image by adding rows, columns, or both

Library: Computer Vision Toolbox / Utilities

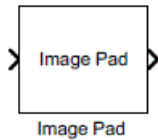

Description

The Image Pad block expands the dimensions of an image by padding its rows, columns, or both.

Ports

Input

I — Input image

matrix | array

Input image, specified as an M -by- N matrix or an M -by- N -by- P array, where P is the number of color planes in the input image.

Data Types: single | double | int8 | int16 | int32 | uint8 | uint16 | uint32 | Boolean | fixed point

PVal — Pad value

scalar

Pad value, specified as a scalar. The block uses this value for each element of the rows or columns added to the input image.

Dependencies

To enable this port, set the **Method** parameter to Constant and the **Pad value source** parameter to Input port.

Data Types: single | double | int8 | int16 | int32 | uint8 | uint16 | uint32 | Boolean

Output

Port_1 — Output image

matrix | array

Output image, returned as a padded matrix or an array. The dimensions of the output image are specified by the **Specify** parameter.

Data Types: single | double | int8 | int16 | int32 | uint8 | uint16 | uint32 | Boolean | fixed point

Parameters

Method — Padding method

Constant (default) | Replicate | Symmetric | Circular

Pad the image using one of these methods:

- **Constant** — Pad the image with a constant value. See “Pad with Constant Value” on page 1-260.
- **Replicate** — Pad the image by repeating the border values of the input image. See “Pad by Repeating Border Values” on page 1-261.
- **Symmetric** — Pad the image using a mirror image of the input data. See “Pad with Mirror Image” on page 1-262.
- **Circular** — Pad the image using a circular repetition of the elements in the input image. See “Pad Using Circular Repetition of Elements” on page 1-262.

Pad value source — Source of constant pad value

Specify via dialog (default) | Input port

Specify the padding source as `Specify via dialog` or `Input port`.

- `Specify via dialog` — Specify a pad value using the **Pad Value** parameter.
- `Input port` — Specify a pad value using the **PVal** input port.

Dependencies

To enable this parameter, set the **Method** parameter to `Constant`.

Pad value — Pad value

0 (default) | scalar

Specify a scalar value with which to pad the image.

Dependencies

To enable this parameter, set the **Method** parameter to `Constant` and the **Pad value source** parameter to `Specify via dialog`.

Specify — Padding size specification format

Pad size (default) | Output size

Select how to specify the size of the image padding from these two options:

- **Pad size** — Specify the number of columns and rows with which to pad the image, using the **Number of added columns** and **Number of added rows** parameters, respectively.
- **Output size** — Specify the size of the padded output image using a combination of the **Output row mode**, **Number of output rows**, **Output column mode**, and **Number of output columns** parameters.

Add columns to — Column padding location

Left (default) | Right | Both left and right | No padding

Select which sides of the input image to pad with additional columns:

- **Left** — Add columns to the left side of the input image.

- `Right` — Add columns to the right side of the input image.
- `Both left and right` — Add columns to both the left and right sides of the input image.
- `No padding` — Do not add columns to the input image.

Output column mode — Output column sizing method

User-specified (default) | Next power of two

Specify the number of columns in the output image using one of these options:

- `User-specified` — Specify the number of columns in the output image using the **Number of output columns** parameter.
- `Next power of two` — Add columns to the input image until the total number of columns is a power of two.

Dependencies

To enable this parameter, set the **Specify** parameter to `Output size`.

Number of output columns — Number of columns in output image

10 (default) | positive integer

Specify the number of columns in the output image as a positive integer M . If the value of this parameter is less than the number of columns in the input image, then the output image contains only the last M columns of the input image.

Dependencies

To enable this parameter, set the **Specify** parameter to `Output size` and the **Output column mode** parameter to `User-specified`.

Number of added columns — Number of columns added to input image

2 (default) | positive integer | two-element vector of positive integers

Specify how many columns to add to the input signal. The behavior of this parameter changes depending on whether you are padding only one side or both sides of the image.

Add columns to	Number of added columns	Description
Left	P	Add P columns to the left side of the input image.
Right	Q	Add Q columns to the right side of the input image.
Both left and right	$[P Q]$	Add P columns to the left side and Q columns to the right side of the input image.

Dependencies

To enable this parameter, set the **Specify** parameter to `Pad size` and the **Add columns to** parameter to `Left`, `Right`, or `Both left and right`.

Add rows to — Row padding location

Top (default) | Bottom | Both top and bottom | No padding

Select which sides of the input image to pad with additional rows:

- **Top** — Add rows to the top of the input image.
- **Bottom** — Add rows to the bottom of the input image.
- **Both top and bottom** — Add rows to both the top and bottom of the input image.
- **No padding** — Do not add rows to the input image.

Output row mode — Output row sizing method

User-specified (default) | Next power of two

Specify the number of rows in the output image using one of these options:

- **User-specified** — Specify the number of rows in the output image using the **Number of output rows** parameter.
- **Next power of two** — Add rows to the input image until the total number of rows is a power of two.

Dependencies

To enable this parameter, set the **Specify** parameter to **Output size**.

Number of output rows — Number of rows in output image

12 (default) | positive integer

Specify the number of rows in the output image as a positive integer N . If the value of this parameter is less than the number of rows in the input image, then the output image contains only the last N rows of the input image.

Dependencies

To enable this parameter, set the **Specify** parameter to **Output size** and the **Output row mode** parameter to **User-specified**.

Number of added rows — Number of rows added to input image

[2 3] (default) | positive integer | two-element vector of positive integers

Specify how many rows to add to the input signal. The behavior of this parameter changes depending on whether you are padding only one side or both sides of the image.

Add rows to	Number of added rows	Description
Top	R	Add R rows to the top of the input image.
Bottom	S	Add S rows to the bottom of the input image.
Both top and bottom	[R S]	Add R rows to the top and S rows to the bottom of the input image.

Dependencies

To enable this parameter, set the **Specify** parameter to **Pad size** and the **Add rows to** parameter to **Top**, **Bottom**, or **Both top and bottom**.

Action when truncation occurs — Action when input signal is truncated

None (default) | Warning | Error

You can specify how the block behaves when the input signal is truncated as one of these options:

- **None** — Does not notify you when the signal is truncated.
- **Warning** — Displays a warning message in the MATLAB command window when the input signal is truncated.
- **Error** — Displays an error dialog box and terminates the simulation when the input signal is truncated.

Dependencies

To enable this parameter, set the **Specify** parameter to `Output size`.

Block Characteristics

Data Types	Boolean double fixed point integer single
Multidimensional Signals	no
Variable-Size Signals	no

More About

Pad with Constant Value

When padding an image with a constant value, every element of the rows and columns the Image Pad block adds to the input image is a specified scalar value.

If you want to pad each of your input signal with three initial values equal to 0, and this is how your input signal is defined:

$$\begin{bmatrix} a_{00} & a_{01} & a_{02} \\ a_{10} & a_{11} & a_{12} \\ a_{20} & a_{21} & a_{22} \end{bmatrix}.$$

Specify these parameters for the Image Pad block:

- **Method** — Constant
- **Pad value source** — Specify via dialog
- **Pad value** — 0
- **Specify** — Output size
- **Add columns to** — Left
- **Output column mode** — User-specified
- **Number of output columns** — 6
- **Add rows to** — No padding

The Image Pad block outputs this signal:

$$\begin{bmatrix} 0 & 0 & 0 & a_{00} & a_{01} & a_{02} \\ 0 & 0 & 0 & a_{10} & a_{11} & a_{12} \\ 0 & 0 & 0 & a_{20} & a_{21} & a_{22} \end{bmatrix} .$$

Pad by Repeating Border Values

When padding an image with the **Method** parameter set to Replicate, the Image Pad block replicates border values of the input signal across all directions.

If you want to pad your input signal with its border values and this is how your input signal is defined:

$$\begin{bmatrix} a_{00} & a_{01} & a_{02} \\ a_{10} & a_{11} & a_{12} \\ a_{20} & a_{21} & a_{22} \end{bmatrix} .$$

Specify these parameters for the Image Pad block:

- **Method** — Replicate
- **Specify** — Pad size
- **Add columns to** — Both left and right
- **Number of added columns** — 2
- **Add rows to** — Both top and bottom
- **Number of added rows** = [1 3]

The Image Pad block outputs this signal:

$$\begin{bmatrix} a_{00} & a_{00} & a_{00} & a_{01} & a_{02} & a_{02} & a_{02} \\ a_{00} & a_{00} & a_{00} & a_{01} & a_{02} & a_{02} & a_{02} \\ a_{10} & a_{10} & a_{10} & a_{11} & a_{12} & a_{12} & a_{12} \\ a_{20} & a_{20} & a_{20} & a_{21} & a_{22} & a_{22} & a_{22} \\ a_{20} & a_{20} & a_{20} & a_{21} & a_{22} & a_{22} & a_{22} \\ a_{20} & a_{20} & a_{20} & a_{21} & a_{22} & a_{22} & a_{22} \\ a_{20} & a_{20} & a_{20} & a_{21} & a_{22} & a_{22} & a_{22} \end{bmatrix} .$$

Input matrix

The border values of the input signal are replicated on the top, bottom, left, and right of the input signal, so that the output is a 7-by-7 matrix. The values in the corners of this output matrix are determined by replicating the border values of the matrices on the top, bottom, left, and right sides of the original input signal.

Pad with Mirror Image

When padding an image with the **Method** parameter set to *Symmetric*, the Image Pad block flips the original input matrix and each matrix it creates, to populate across all directions of the input signal.

If you want to pad your input signal using its mirror image and this is how your input signal is defined:

$$\begin{bmatrix} a_{00} & a_{01} & a_{02} \\ a_{10} & a_{11} & a_{12} \\ a_{20} & a_{21} & a_{22} \end{bmatrix}.$$

Specify these parameters for the Image Pad block:

- **Method** — *Symmetric*
- **Specify** — Pad size
- **Add columns to** — Both left and right
- **Number of added columns** — [5 6]
- **Add rows to** — Both top and bottom
- **Number of added rows** — 2

The Image Pad block outputs this signal:

$$\begin{bmatrix} a_{11} & a_{12} & a_{12} & a_{11} & a_{10} & a_{10} & a_{11} & a_{12} & a_{12} & a_{11} & a_{10} & a_{10} & a_{11} & a_{12} \\ a_{01} & a_{02} & a_{02} & a_{01} & a_{00} & a_{00} & a_{01} & a_{02} & a_{02} & a_{01} & a_{00} & a_{00} & a_{01} & a_{02} \\ a_{01} & a_{02} & a_{02} & a_{01} & a_{00} & a_{00} & a_{01} & a_{02} & a_{02} & a_{01} & a_{00} & a_{00} & a_{01} & a_{02} \\ a_{11} & a_{12} & a_{12} & a_{11} & a_{01} & a_{10} & a_{11} & a_{12} & a_{12} & a_{11} & a_{10} & a_{10} & a_{11} & a_{12} \\ a_{21} & a_{22} & a_{22} & a_{21} & a_{20} & a_{20} & a_{21} & a_{22} & a_{22} & a_{21} & a_{20} & a_{20} & a_{21} & a_{22} \\ a_{21} & a_{22} & a_{22} & a_{21} & a_{20} & a_{20} & a_{21} & a_{22} & a_{22} & a_{21} & a_{20} & a_{20} & a_{21} & a_{22} \\ a_{11} & a_{12} & a_{12} & a_{11} & a_{01} & a_{01} & a_{11} & a_{12} & a_{12} & a_{11} & a_{10} & a_{10} & a_{11} & a_{12} \end{bmatrix} \cdot$$

Input matrix

The block flips the original input matrix and each matrix it creates about their top, bottom, left, and right sides to populate the 7-by-13 output signal. For example, the block flips the input matrix about its right side to create the matrix directly to its right, but flips that second matrix about its bottom to create the matrix below it.

Pad Using Circular Repetition of Elements

When padding an image with the **Method** parameter set to *Circular*, the Image Pad block repeats the values of the input signal in a circular pattern across all directions.

If you want to pad your input signal using a circular repetition of its values and this is how your input signal is defined:

$$\begin{bmatrix} a_{00} & a_{01} & a_{02} \\ a_{10} & a_{11} & a_{12} \\ a_{20} & a_{21} & a_{22} \end{bmatrix}.$$

Specify these parameters for the Image Pad block:

- **Method** — Circular
- **Specify** — Output size
- **Add columns to** — Both left and right
- **Number of output columns** — 9
- **Add rows to** — Both top and bottom
- **Number of output rows** — 9

The Image Pad block outputs this signal:

$$\begin{bmatrix} a_{00} & a_{01} & a_{02} & a_{00} & a_{01} & a_{02} & a_{00} & a_{01} & a_{02} \\ a_{10} & a_{11} & a_{12} & a_{10} & a_{11} & a_{12} & a_{10} & a_{11} & a_{12} \\ a_{20} & a_{21} & a_{22} & a_{20} & a_{21} & a_{22} & a_{20} & a_{21} & a_{22} \\ a_{00} & a_{01} & a_{02} & a_{00} & a_{01} & a_{02} & a_{00} & a_{01} & a_{02} \\ a_{10} & a_{11} & a_{12} & a_{10} & a_{11} & a_{12} & a_{10} & a_{11} & a_{12} \\ a_{20} & a_{21} & a_{22} & a_{20} & a_{21} & a_{22} & a_{20} & a_{21} & a_{22} \\ a_{00} & a_{01} & a_{02} & a_{00} & a_{01} & a_{02} & a_{00} & a_{01} & a_{02} \\ a_{10} & a_{11} & a_{12} & a_{10} & a_{11} & a_{12} & a_{10} & a_{11} & a_{12} \\ a_{20} & a_{21} & a_{22} & a_{20} & a_{21} & a_{22} & a_{20} & a_{21} & a_{22} \end{bmatrix}.$$

Input matrix

The block repeats the values of the input signal in a circular pattern to populate the 9-by-9 output matrix.

Extended Capabilities

C/C++ Code Generation

Generate C and C++ code using Simulink® Coder™.

See Also

Selector | Submatrix | imcrop

Introduced in R2007a

Insert Text

Draw text on images or video frames

Library: Computer Vision Toolbox / Text & Graphics



Description

The Insert Text block draws formatted text on an input image or video stream. The block produces stylized text bitmaps using the open-source font engine Free Type 2.3.5 library. For more information about the library, see The FreeType Project website.

Note This block supports only ASCII characters.

This block enables you to draw:

- A single instance of text
- Multiple instance of the same text
- Multiple instances of text, with different text at each location

Ports

Input

Image — Input image

matrix | array

Input image or video, specified as an M -by- N matrix, M -by- N -by- T array, M -by- N -by- C array, or M -by- N -by- C -by- T array. T is the number of frames in a video or image sequence, and C is the number of color channels.

Dependencies

To enable this port, set the **Image signal** parameter to **One multidimensional signal**.

Data Types: single | double | int8 | int16 | int32 | uint8 | uint16 | uint32 | Boolean

R — Red color component of input image

matrix | array

Red color component of the input image or video, specified as an M -by- N matrix or M -by- N -by- T array, where T is the number of frames in the input video.

Note Inputs to the **R**, **G**, and **B** ports must have the same dimensions and data type.

Dependencies

To enable this port, set the **Image signal** parameter to `Separate color signals`.

Data Types: `single` | `double` | `int8` | `int16` | `int32` | `uint8` | `uint16` | `uint32` | `Boolean`

G — Green color component of input image

`matrix` | `array`

Green color component of the input image or video, specified as an M -by- N matrix or M -by- N -by- T array, where T is the number of frames in the input video.

Note Inputs to the **R**, **G**, and **B** ports must have the same dimensions and data type.

Dependencies

To enable this port, set the **Image signal** parameter to `Separate color signals`.

Data Types: `single` | `double` | `int8` | `int16` | `int32` | `uint8` | `uint16` | `uint32` | `Boolean`

B — Blue color component of input image

`matrix` | `array`

Blue color component of the input image or video, specified as an M -by- N matrix or M -by- N -by- T array, where T is the number of frames in the input video.

Note Inputs to the **R**, **G**, and **B** ports must have the same dimensions and data type.

Dependencies

To enable this port, set the **Image signal** parameter to `Separate color signals`.

Data Types: `single` | `double` | `int8` | `int16` | `int32` | `uint8` | `uint16` | `uint32` | `Boolean`

Select — Select text string

positive integer

Select text string, specified as a positive integer. When the value of the **Text** parameter is a cell array of character vectors, the Insert Text block displays the text string from only the cell indicated by the input value of the **Select** port. Input to this port must be in the range from 1 to the number of text strings in the cell array, where 1 indicates the first character vector.

Dependencies

To enable this port, specify the **Text** parameter as a cell array of character vectors, such as `{'Text1', 'Text2'}`.

Data Types: `single` | `double`

Color — Text color value

`scalar` | `vector` | `matrix`

Text color value, specified as a scalar, vector or matrix. The data type of the input image determines the range of color values. For example, a color value for a floating-point input image data type must

be in the range [0, 1]. For an input image with a uint8 data type, the value must be in the range [0, 255]. The shape of the input to this port depends on whether the input signal is intensity-based or color.

- Intensity signal — Specify **Color** as either a scalar intensity value, in which case the block applies the intensity to all text strings, or as a vector of intensity values of length equal to the number of text strings specified to the **Text** parameter.
- Color signal — Specify **Color** as either a three-element vector that defines the color of all text strings as an RGB triplet, or an *S*-by-3 matrix of color values, where *S* is the number of text strings specified to the **Text** parameter.

Note The input to this port must be of the same data type as the input image.

Dependencies

To enable this port, set the **Color value source** parameter to Input port.

Data Types: single | double | int8 | int16 | int32 | uint8 | uint16 | uint32

Location — Location index

vector | matrix

Location index, a two-element vector or an *S*-by-2 matrix, specifies the coordinates of input image at which to insert the text. If specified as a two-element vector, the first element represents the row and the second element represents the column of the image at which to insert the character vector. If specified as an *S*-by-2 matrix, each row contains the row and column indices of a location in the image at which to display the text.

Dependencies

To enable this port, set the **Location source** parameter to Input port.

Data Types: single | double | int8 | int16 | int32 | uint8 | uint16 | uint32

Opacity — Opacity factor

scalar | vector

Opacity factor, specified as a scalar or a vector. If specified as a scalar, the opacity factor applies to all text strings. If specified as a vector of opacity values, the length of the vector must be equal to the number of text strings specified in the **Text** parameter. Each element of the opacity factor can range from 0 to 1.

Dependencies

To enable this port, set the **Opacity source** parameter to Input port.

Data Types: single | double

Variables — Text variable values

scalar | vector

Text variable values, specified as scalar or vector. The block replaces the format specifications in the **Text** parameter, such as %d, %f, or %s, with the elements of this input. Use the %s option to specify a set of text strings separated with a value 0 for the block to display simultaneously at different locations. For example, to insert two strings, use a Constant block, and specify its value to

[uint8('Text1') 0 uint8('Text2')] at **Variables** input port. For more information on format specifiers see `sprintf`.

Dependencies

To enable this port, enter ANSI C `printf`-style format specifications, such as `%d`, `%f`, or `%s` to the **Text** parameter.

Data Types: uint8 | double

Output

Port_1 — Output image or video

matrix | array

Output image or video, returned as an M -by- N matrix, M -by- N -by- T array, M -by- N -by- C array, or M -by- N -by- C -by- T array. T is the number of frames in a video or image sequence, and C is the number of color channels.

Dependencies

To enable this port, set the **Image signal** parameter to `One multidimensional signal`.

Data Types: single | double | int8 | int16 | int32 | uint8 | uint16 | uint32 | Boolean

R — Red color component of output image

matrix | array

Red color component of the output image or video, returned as an M -by- N matrix or M -by- N -by- T array, where T is the number of frames in the output video.

Dependencies

To enable this port, set the **Image signal** parameter to `Separate color signals`.

Data Types: single | double | int8 | int16 | int32 | uint8 | uint16 | uint32 | Boolean

G — Green color component of output image

matrix | array

Green color component of the output image or video, returned as an M -by- N matrix or M -by- N -by- T array, where T is the number of frames in the output video.

Dependencies

To enable this port, set the **Image signal** parameter to `Separate color signals`.

Data Types: single | double | int8 | int16 | int32 | uint8 | uint16 | uint32 | Boolean

B — Blue color component of output image

matrix | array

Blue color component of the output image or video, returned as an M -by- N matrix or M -by- N -by- T array, where T is the number of frames in the output video.

Dependencies

To enable this port, set the **Image signal** parameter to `Separate color signals`.

Data Types: single | double | int8 | int16 | int32 | uint8 | uint16 | uint32 | Boolean

Parameters

Main

Text — Text to insert

'Text' (default) | string | scalar | character vector | cell array of character vectors

Specify the text to insert into the input image.

- You can specify this parameter as either a single text string or character vector, such as 'Text1', or as a cell array of character vectors, such as {'Text1', 'Text2'}. If you specify a cell array, then you must also specify which text string to display by using the **Select** input port.
- You can include ANSI C printf-style format specifications, such as 'Text %d'. You must then specify their values by using the **Variable** input port. Supported format specifiers include %d, %i, %u, %c, %f, %o, %x, %X, %e, %E, %g, and %G. For more information on format specifiers see `sprintf`.

Color value source — Source of text color

Specify via dialog (default) | Input port

Select a text color source from these options: `Specify via dialog` and `Input port`. If you set this parameter to `Specify via dialog`, then you must specify text colors by using the **Color value** parameter. If you set this parameter to `Input port`, then you must specify text colors by using the **Color** input port.

Color value — Text color value

[0 0 0] (default) | scalar | vector | matrix

Text color value, specified as a scalar, vector or matrix. The data type of the input image determines the range of color values. For example, a color value for a floating-point input image data type must be in the range [0, 1]. For an input image with a uint8 data type, the value must be in the range [0, 255]. The size of the text color value depends on whether the input signal is intensity-based or color.

- Intensity signal — Specify **Color** as either a scalar intensity value, in which case the block applies the intensity to all text strings, or as a vector of intensity values of length equal to the number of text strings specified to the **Text** parameter.
- Color signal — Specify **Color** as either a three-element vector that defines the color of all text strings as an RGB triplet, or an *S*-by-3 matrix of color values, where *S* is the number of text strings specified to the **Text** parameter.

Dependencies

To enable this parameter, set the **Color value source** parameter to `Specify via dialog`.

Location source — Source of text location indices

Specify via dialog (default) | Input port

Select a text location source from these options: `Specify via dialog` and `Input port`. If you set this parameter to `Specify via dialog`, then you must specify text locations by using the **Location [x y]** parameter. If you set this parameter to `Input port`, then you must specify text locations by using the **Location** input port.

Location [x y] — Text location index

[1, 1] (default) | vector | matrix

Text location index, a two-element vector or an S -by-2 matrix, specifies the coordinates of input image at which to insert the text. If specified as a two-element vector, the first element represents the row and the second element represents the column of the image at which to insert the character vector. If specified as an S -by-2 matrix, each row contains the row and column indices of a location in the image at which to display the text.

Dependencies

To enable this parameter, set the **Location source** parameter to `Specify via dialog`.

Opacity source — Source of opacity factor

`Specify via dialog` (default) | `Input port`

Select the opacity factor source from these options: `Specify via dialog` and `Input port`. If you set this parameter to `Specify via dialog`, then you must specify opacity factor by using the **Opacity** parameter. If you set this parameter to `Input port` then you must specify opacity factor by using the **Opacity** input port.

Opacity — Opacity factor

1 (default) | scalar | vector

Opacity factor, specified as a scalar or a vector. If specified as a scalar, the opacity factor applies to all text strings. If specified as a vector of opacity values, the length of the vector must be equal to the number of text strings specified in the **Text** parameter. Each element of the opacity factor can range from 0 to 1.

Dependencies

To enable this parameter, set the **Opacity source** parameter to `Specify via dialog`.

Image signal — Input and output signal format

`One multidimensional signal` (default) | `Separate color signals`

Specify the format of the input and output images of the block using these options:

- `One multidimensional signal` — The block has a single input port and single output port.
- `Separate color signals` — The block has three input and output signals, one for each color channel, which accept and return the individual color channels of the image.

Input image is transposed (data order is row major) — mirror text and text location

`off` (default) | `on`

Enable this parameter to mirror the text string and reverse its location in the image from $[x \ y]$ to $[y \ x]$.

Font

Font face — Font of text

`LucidaSansRegular` (default) | `Agency FB` | `Agency FB Bold` | `Algerian` | `Ariel` | `Arial Black` | `Arial Bold` | `Arial Bold Italic` | ...

Specify the font of the inserted text. The block populates this list with the fonts installed on your system. On Windows, the block searches the system registry for font files. On UNIX, the block searches the font path of the X Server for font files.

Font size (points) – Font size

12 (default) | positive scalar

Specify the font size of the inserted text.

Anti-aliased – Smooth text edges

on (default) | off

Enable this parameter to smooth the edges of the inserted text. The smoothing process is computationally expensive.

Block Characteristics

Data Types	Boolean double fixed point ^a integer single
Multidimensional Signals	yes
Variable-Size Signals	yes

a. Supports word lengths less than or equal to 32 bits.

Extended Capabilities**C/C++ Code Generation**

Generate C and C++ code using Simulink® Coder™.

See Also

[Draw Shapes](#) | [Draw Markers](#)

Introduced in R2013a

Label

Label connected components in binary image

Library: Computer Vision Toolbox / Morphological Operations



Description

The Label block finds and labels the connected components or objects in a 2-D binary image. The block ignores the background pixels in the input image and searches for connected components within remaining pixels. The block then labels all the pixels of each connected component with a unique number and computes the number of labeled objects.

Ports

Input

BW — Input binary image

vector | matrix

The input image must be a vector or matrix of binary values, each element representing a pixel of the image. The block categorizes pixels with a value of 0 as background pixels, searching for connected components within pixels with a value of 1.

Data Types: Boolean

Output

Label — Labeled objects

vector | matrix

Labeled objects in the input image, returned as a vector or matrix of nonnegative integers. The elements of the output vector or matrix labeled 0 represent the background, the elements labeled 1 represent the first object, the elements labeled 2 represent the second object, and so on. The size of this output matches the size of the **BW** input.

Dependencies

To enable this port, set the **Output** parameter to either `Label matrix` or `Label matrix and number of labels`.

Data Types: uint8 | uint16 | uint32

Count — Number of labeled objects

scalar

Number of labeled objects, returned as a scalar.

Dependencies

To enable this port, set the **Output** parameter to either `Number of labels` or `Label matrix` and `number of labels`.



Data Types: `uint8` | `uint16` | `uint32`

Parameters

Connectivity — Type of pixel connectivity

8 (default) | 4

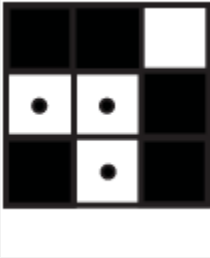
Specify how the block defines which pixels are connected to each other. If you want to connect adjacent pixels in only the horizontal and vertical directions, select 4. If you want to connect adjacent pixels in the horizontal, vertical, and diagonal directions, select 8. These figures show how the block defines a connected component for 4-connected and 8-connected pixels. The block considers the white pixels marked by black circles to be connected to each other.

Type of Connectivity	Connected Pixels
4-connected pixels	
8-connected pixels	

Output — Block output

`Label matrix` and `number of labels` (default) | `Label matrix` | `Number of labels`

Specify the block output as one of these options:

- `Label matrix` — The block outputs the labeled objects at the **Label** port.
- `Number of labels` — The block outputs the number of labeled objects at the **Count** port.
- `Label matrix` and `number of labels` — The block outputs both the labeled objects and number of labeled objects to the **Label** and **Count** ports, respectively.

Output data type — Data type of output

`Automatic` (default) | `uint8` | `uint16` | `uint32`

Specify the data type of the outputs at the **Label** and **Count** ports. When you specify this parameter as `Automatic`, the block calculates the maximum number of objects that can fit inside the image based on the image size and the specified connectivity. Using this calculation, it chooses the output data type with the minimum value that guarantees unique region labels.

If label exceeds data type size, mark remaining regions using — Overflow mode of output labels

maximum value of the output data type (default) | zero

Use this parameter to specify the behavior of the block when the block finds more objects than the maximum possible value the output data type can represent. The block labels the remaining objects with the value determined by one of these options:

- maximum value of the output data type — The block labels the remaining objects with the maximum value of the output data type.
- zero — The block labels the remaining objects with 0.

Dependencies

To enable this parameter, set the **Output data type** parameter to either `uint8` or `uint16`.

Block Characteristics

Data Types	Boolean integer
Multidimensional Signals	no
Variable-Size Signals	yes

Extended Capabilities

C/C++ Code Generation

Generate C and C++ code using Simulink® Coder™.

See Also

Blocks

Dilation | Erosion | Opening | Closing | Blob Analysis

Functions

`bwconncomp` | `bwselect` | `regionprops` | `bwlabel` | `bwlabeln`

Introduced before R2006a

Median Filter

Perform 2-D median filtering

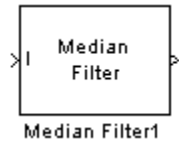

Library

Filtering and Analysis & Enhancement

visionanalysis

visionfilter

Description

The Median Filter block replaces the central value of an M -by- N neighborhood with its median value. If the neighborhood has a center element, the block places the median value there, as illustrated in the following figure.

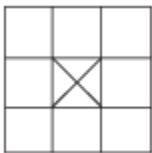

The block has a bias toward the upper-left corner when the neighborhood does not have an exact center. See the median value placement in the following figure.

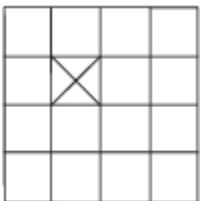

The block pads the edge of the input image, which sometimes causes the pixels within $[M/2 \ N/2]$ of the edges to appear distorted. The median value is less sensitive than the mean to extreme values. As a result, the Median Filter block can remove salt-and-pepper noise from an image without significantly reducing the sharpness of the image.

Port	Input/Output	Supported Data Types	Complex Values Supported
I	Matrix of intensity values	<ul style="list-style-type: none"> • Double-precision floating point • Single-precision floating point • Fixed point • Boolean • 8-, 16-, 32-bit signed integer • 8-, 16-, 32-bit unsigned integer 	No
Val	Scalar value that represents the constant pad value	Same as I port	No
Output	Matrix of intensity values	Same as I port	No

If the data type of the input signal is floating point, the output has the same data type. The data types of the signals input to the I and Val ports must be the same.

Fixed-Point Data Types

The information in this section is applicable only when the dimensions of the neighborhood are even.

For fixed-point inputs, you can specify accumulator and output data types as discussed in “Parameters” on page 1-275. Not all these fixed-point parameters apply to all types of fixed-point inputs. The following table shows the output and accumulator data type used for each fixed-point input.

Fixed-Point Input	Output Data Type	Accumulator Data Type
Even M	X	X
Odd M	X	
Odd M and complex	X	X
Even M and complex	X	X

When M is even, fixed-point signals use the accumulator and output data types. The accumulator data type store the result of the sum performed while calculating the average of the two central rows of the input matrix. The output data type stores the total result of the average.

Complex fixed-point inputs use the accumulator parameters. The calculation for the sum of the squares of the real and imaginary parts of the input occur, before sorting input elements. The accumulator data type stores the result of the sum of the squares.

Parameters

Neighborhood size

Specify the size of the neighborhood over which the block computes the median.

- Enter a scalar value that represents the number of rows and columns in a square matrix.
- Enter a vector that represents the number of rows and columns in a rectangular matrix.

Output size

This parameter controls the size of the output matrix.

- If you choose `Same as input port I`, the output has the same dimensions as the input to port I. The **Padding options** parameter appears in the dialog box. Use the **Padding options** parameter to specify how to pad the boundary of your input matrix.
- If you select `Valid`, the block only computes the median where the neighborhood fits entirely within the input image, with no need for padding. The dimensions of the output image are, $\text{output rows} = \text{input rows} - \text{neighborhood rows} + 1$, and $\text{output columns} = \text{input columns} - \text{neighborhood columns} + 1$.

Padding options

Specify how to pad the boundary of your input matrix.

- Select `Constant` to pad your matrix with a constant value. The **Pad value source** parameter appears in the dialog box
- Select `Replicate` to pad your input matrix by repeating its border values.
- Select `Symmetric` to pad your input matrix with its mirror image.
- Select `Circular` to pad your input matrix using a circular repetition of its elements. This parameter appears if, for the **Output size** parameter, you select `Same as input port I`.

For more information on padding, see the Image Pad block reference page.

Pad value source

Use this parameter to specify how to define your constant boundary value.

- Select `Specify via dialog` to enter your value in the block parameters dialog box. The **Pad value** parameter appears in the dialog box.
- Select `Input port` to specify your constant value using the `Val` port. This parameter appears if, for the **Padding options** parameter, you select `Constant`.

Pad value

Enter the constant value with which to pad your matrix. This parameter appears if, for the **Pad value source** parameter, you select `Specify via dialog`. Tunable.

Rounding mode

Select the rounding mode for fixed-point operations.

Overflow mode

Select the overflow mode for fixed-point operations.

Note Only certain cases require the use of the accumulator and output parameters. Refer to “Fixed-Point Data Types” on page 1-275 for more information.

Accumulator

Use this parameter to specify the accumulator word and fraction lengths resulting from a complex-complex multiplication in the block:

- When you select `Same as input`, these characteristics match the related input to the block.

- When you select `Binary point scaling`, you can enter the word length and the fraction length of the accumulator, in bits.
- When you select `Slope and bias scaling`, you can enter the word length, in bits, and the slope of the accumulator. This block requires power-of-two slope and a bias of 0.

Output

Choose how to specify the output word length and fraction length:

- When you select `Same as input`, these characteristics match the related input to the block.
- When you select `Binary point scaling`, you can enter the word length and the fraction length of the output, in bits.
- When you select `Slope and bias scaling`, you can enter the word length, in bits, and the slope of the output. This block requires power-of-two slope and a bias of 0.

Lock data type settings against change by the fixed-point tools

Select this parameter to prevent the fixed-point tools from overriding the data types you specify on the block mask. For more information, see `fxptdlg`, a reference page on the Fixed-Point Tool in the Simulink documentation.

References

- [1] Gonzales, Rafael C. and Richard E. Woods. *Digital Image Processing. 2nd ed.* Englewood Cliffs, NJ: Prentice-Hall, 2002.

See Also

2-D Convolution	Computer Vision Toolbox
2-D FIR Filter	Computer Vision Toolbox
<code>medfilt2</code>	Image Processing Toolbox

Extended Capabilities

C/C++ Code Generation

Generate C and C++ code using Simulink® Coder™.

Introduced before R2006a

Matrix To Image

Converts matrix data to Simulink image data

Library: Computer Vision Toolbox OpenCV Interface for Simulink



Description

The Matrix To Image block converts matrix data to Simulink image data.

Ports

Input

Port_1 — Input signal

matrix

Input signal to the Matrix To Image block. The input is a numerical matrix.

Data Types: uint8 | uint16 | int8 | int16 | single | double

Output

Port_1 — Output signal

Simulink.ImageType

Output signal from the Matrix To Image block. The output is an image in Simulink.ImageType data type.

Data Types: Simulink.ImageType

Parameters

Rows — Number of rows in image data

'480' (default) | positive integer

Specify the number of rows in the image data as a positive integer.

Programmatic Use

Block Parameter: Rows

Type: double

Value: positive integer

Default: '480'

Columns — Number of columns in image data

'640' (default) | positive integer

Specify the number of columns in the image data as a positive integer.

Programmatic Use**Block Parameter:** Columns**Type:** double**Value:** positive integer**Default:** '640'**Channels — Number of color channels or samples for each pixel in the array**

3 (default) | 1

Specify the number of color channels or samples for each pixel in the array as 1 or 3. The number of channels must correspond to the number of color channels in the color format of the image data.

These are the values of **Channels** for the supported color formats:

Channels	Color Format
1	Grayscale
3	RGB
3	BGR

Programmatic Use**Block Parameter:** Columns**Type:** character vector**Value:** positive integer**Default:** '3'**Underlying Datatype — Data type of underlying image data**

'uint8' (default) | 'int8' | 'uint16' | 'int16' | 'uint32' | 'int32' | 'single' | 'double' | 'logical'

Specify the data type of the underlying image data as one of these options:

- 'uint8'
- 'int8'
- 'uint16'
- 'int16'
- 'uint32'
- 'int32'
- 'single'
- 'double'
- 'logical'

Programmatic Use**Block Parameter:** ClassUnderlying**Type:** character vector**Value:** 'uint8' | 'int8' | 'uint16' | 'int16' | 'uint32' | 'int32' | 'single' | 'double' | 'logical'**Default:** 'uint8'**Array Layout — Memory arrangement of matrix data in image**

'Column-major' (default) | 'Row-major'

Specify the memory arrangement of the matrix data in the image as Column-major or Row-major.

Programmatic Use**Block Parameter:** Layout**Type:** character vector**Value:** 'Column-major' | 'Row-major'**Default:** 'Column-major'**Color Format — Color format of pixels in underlying image data**

'RGB' (default) | 'Grayscale' | 'BGR'

Specify what each color channel of a pixel represents in the underlying image data as Grayscale, RGB, or BGR.

Programmatic Use**Block Parameter:** ColorFormat**Type:** character vector**Value:** 'Grayscale' | 'RGB' | 'BGR'**Default:** 'RGB'**Block Characteristics**

Data Types	double single uint8 uint16 int8 int16 int32 image
Direct Feedthrough	Yes
Multidimensional Signals	Yes
Variable-Size Signals	No

Extended Capabilities**C/C++ Code Generation**

Generate C and C++ code using Simulink® Coder™.

Supports C++ code generation.

See Also

Image To Matrix

Topics

"Install and Use Computer Vision Toolbox Interface for OpenCV in Simulink"

Introduced in R2021b

Deep Learning Object Detector

Detect objects using trained deep learning object detector

Library: Computer Vision Toolbox / Analysis & Enhancement

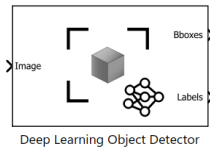

Description

The Deep Learning Object Detector block predicts bounding boxes, class labels, and scores for the input image by using the trained object detector specified through the block parameter. This block allows loading of a pretrained object detector into the Simulink model from a MAT file or from a MATLAB function. This block provides a graphical interface for using the detector objects in Simulink. To enable some parameters of the Deep Learning Object Detector block you must choose an object detector that supports those parameters. For example, using a `yolov2objectDetector` object with this block enables you to select parameters similar to the name-value arguments of the associated `detect` object function.

Ports

Input

Image — Image data

array

An H -by- W -by- C numeric array, where H , W , and C are the height, width, and number of channels of the image, respectively. Only one image per time step is allowed as input.

Output

Bboxes — Locations of objects detected

matrix

Locations of the objects detected within the input image, returned as an M -by-4 matrix. M is the number of bounding boxes detected in the image. You can put an upper bound to the size M by specifying the **Maximum Number of Detections** parameter. Each row of **Bboxes** is of the form $[x \ y \ width \ height]$, specifying the upper-left corner and size of the corresponding bounding box in pixels.

Labels — Labels for bounding boxes

vector

Labels for the bounding boxes, returned as an M -by-1 enumerated vector. M is the number of bounding boxes detected in the image.

Scores — Detection scores

vector

Detection confidence scores for each label, returned as an M -by-1 vector. M is the number of bounding boxes detected in the image. A higher score indicates higher confidence in the detection.

Parameters

Detector — Source for trained detector object

Detector from MAT file (default) | Detector from MATLAB function

Select the source for the detector object from these options:

- **Detector from MAT file** — Import a detector object from a MAT file. For example, select a MAT file containing an `rcnnObjectDetector` object.
- **Detector from MATLAB function** — Import a detector object from a MATLAB function. For example, specify the function `vehicleDetectorYOLOv2`, which returns a trained `yolov2ObjectDetector` object.

The imported detector must be one of these supported objects:

- `rcnnObjectDetector`
- `fastRCNNObjectDetector`
- `fasterRCNNObjectDetector`
- `ssdObjectDetector`
- `yolov2ObjectDetector`

Programmatic Use

Block Parameter: Detector

Type: character vector, string

Values: Detector from MAT file | 'Detector from MATLAB function'

Default: Detector from MAT file'

File path — MAT file containing detector object

untitled.mat (default) | MAT file name

This parameter specifies the name of the MAT file that contains the detector object to load. If the file is not on the MATLAB path, use the **Browse** button to locate the file.

Dependencies

To enable this parameter, set the **Detector** parameter to `Detector from MAT file`.

Programmatic Use

Block Parameter: DetectorFilePath

Type: character vector, string

Values: MAT file path or name

Default: 'untitled.mat'

MATLAB function — MATLAB function name

untitled (default) | MATLAB function name

This parameter specifies the name of the MATLAB function that returns a trained object detector. For example, specify the function `vehicleDetectorYOLOv2`, which returns a trained `yolov2ObjectDetector` object, or specify a custom function.

Dependencies

To enable this parameter, set the **Detector** parameter to `Detector from MATLAB function`.

Programmatic Use**Block Parameter:** DetectorFunction**Type:** character vector, string**Values:** MATLAB function name**Default:** 'untitled'**Region of interest – Search region of interest**vector of the form $[x \ y \ width \ height]$

Specify the search region of interest as vector of the form $[x \ y \ width \ height]$. The vector specifies the upper-left corner and size of a region in pixels.

Dependencies

To enable this parameter, select the **Specify region of interest** parameter.

Programmatic Use**Block Parameter:** ROI**Type:** character vector, string**Values:** character vector specified as ' $[x \ y \ width \ height]$ '**Default:** '[1 1 100 100]'**Detection threshold – Detection threshold**scalar in the range $[0, 1]$

Specify the detection threshold as scalar in the range $[0, 1]$. Detections that have scores lower than this threshold value are removed. To reduce false positives, increase this value.

Dependencies

To enable this parameter, you must use a detector that supports the **Detection threshold** parameter. For example, use a `yolov2objectDetector` object.

Programmatic Use**Block Parameter:** Threshold**Type:** character vector, string**Values:** scalar**Default:** '0.5'**Number of Strongest Regions – Maximum number of strongest region proposals**

2000 (default) | positive integer

Specify the maximum number of strongest region proposals as an integer. Reduce this value to speed up processing at the cost of detection accuracy. To use all region proposals, specify this parameter as `Inf`.

Dependencies

To enable this parameter, use a detector that supports the **Number of Strongest Regions** parameter. For example, use an `rcnnObjectDetector` object.

Programmatic Use**Block Parameter:** NumStrongestRegions**Type:** character vector, string**Values:** integer**Default:** '2000'

Maximum Region Size — Maximum region sizevector of the form *[height width]*

Specify the maximum region size as a vector of the form *[height width]*. Units are in pixels. The maximum region size defines the size of the largest region containing the object. For example, `[50 50]` sets the size of the largest region containing the object to 50-by-50 pixels. To reduce computation time, set this value to the known maximum region size for the objects that can be detected in the input test images.

Dependencies

To enable this parameter

- Select the **Specify maximum region size** parameter.
- Use a detector that supports the **Maximum Region Size** parameter. For example, use a `yoloV2ObjectDetector` object.

Programmatic Use**Block Parameter:** `MaxSize`**Type:** character vector, string**Values:** character vector specified as '*[height width]*'**Default:** '`[50 50]`'**Minimum Region Size — Minimum region size**vector of the form *[height width]*

Specify the minimum region size as a vector of the form *[height width]*. Units are in pixels. The minimum region size defines the size of the smallest region containing the object. For example, `[1 1]` sets the size of the smallest region containing the object to 1-by-1 pixels.

Dependencies

To enable this parameter

- Select the **Specify minimum region size** parameter.
- Use a detector that supports the **Minimum Region Size** parameter. For example, use a `yoloV2ObjectDetector` object.

Programmatic Use**Block Parameter:** `MinSize`**Type:** character vector, string**Values:** character vector specified as '*[height width]*'**Default:** '`[1 1]`'**Maximum Number of Detections — Maximum number of detections**

500 (default) | positive integer

Specify the maximum number of detections as a positive integer. This value is the upper bound for the number of detections.

Programmatic Use**Block Parameter:** `MaxDetections`**Type:** character vector, string**Values:** integer**Default:** '`500`'

Extended Capabilities

C/C++ Code Generation

Generate C and C++ code using Simulink® Coder™.

Usage notes and limitations:

- The **Language** parameter in the **Configuration Parameters > Code Generation** general category must be set to C++.
- For a list of networks and layers supported for code generation, see “Networks and Layers Supported for Code Generation” (MATLAB Coder).

GPU Code Generation

Generate CUDA® code for NVIDIA® GPUs using GPU Coder™.

Usage notes and limitations:

- The **Language** parameter in the **Configuration Parameters > Code Generation** general category must be set to C++.
- For a list of networks and layers supported for CUDA® code generation, see “Supported Networks, Layers, and Classes” (GPU Coder).

See Also

Objects

[rcnnObjectDetector](#) | [fastRCNNObjectDetector](#) | [fasterRCNNObjectDetector](#) | [ssdObjectDetector](#) | [yolov2ObjectDetector](#)

Blocks

[Image Classifier \(Deep Learning Toolbox\)](#) | [Predict \(Deep Learning Toolbox\)](#)

Introduced in R2021b

Opening

Perform morphological opening on binary or intensity images



Library

Morphological Operations

visionmorphops

Description

The Opening block performs an erosion operation followed by a dilation operation using a predefined neighborhood or structuring element. This block uses flat structuring elements only.

Port	Input/Output	Supported Data Types	Complex Values Supported
	Vector or matrix of intensity values	<ul style="list-style-type: none"> • Double-precision floating point • Single-precision floating point • Fixed point • Boolean • 8-, 16-, and 32-bit signed integer • 8-, 16-, and 32-bit unsigned integer 	No
Nhood	Matrix or vector of ones and zeros that represents the neighborhood values	Boolean	No
Output	Scalar, vector, or matrix of intensity values that represents the opened image	Same as I port	No

The output signal has the same data type as the input to the I port.

Use the **Neighborhood or structuring element source** parameter to specify how to enter your neighborhood or structuring element values. If you select *Specify via dialog*, the **Neighborhood or structuring element** parameter appears in the dialog box. If you select *Input port*, the Nhood port appears on the block. Use this port to enter your neighborhood values as a matrix or vector of 1s and 0s. You can only specify a structuring element using the dialog box.

Use the **Neighborhood or structuring element** parameter to define the region the block moves throughout the image. Specify a neighborhood by entering a matrix or vector of 1s and 0s. Specify a structuring element with the `strel` function from the Image Processing Toolbox. If the structuring element is decomposable into smaller elements, the block executes at higher speeds due to the use of a more efficient algorithm.

Parameters

Neighborhood or structuring element source

Specify how to enter your neighborhood or structuring element values. Select **Specify via dialog** to enter the values in the dialog box. Select **Input port** to use the Nhood port to specify the neighborhood values. You can only specify a structuring element using the dialog box.

Neighborhood or structuring element

If you are specifying a neighborhood, this parameter must be a matrix or vector of 1s and 0s. If you are specifying a structuring element, use the `strel` function from the Image Processing Toolbox. This parameter is visible if, for the **Neighborhood or structuring element source** parameter, you select **Specify via dialog**.

References

[1] Soille, Pierre. *Morphological Image Analysis. 2nd ed.* New York: Springer, 2003.

See Also

Bottom-hat	Computer Vision Toolbox software
Closing	Computer Vision Toolbox software
Dilation	Computer Vision Toolbox software
Erosion	Computer Vision Toolbox software
Label	Computer Vision Toolbox software
Top-hat	Computer Vision Toolbox software
imopen	Image Processing Toolbox software
strel	Image Processing Toolbox software

Extended Capabilities

C/C++ Code Generation

Generate C and C++ code using Simulink® Coder™.

Introduced before R2006a

Optical Flow

Estimate object velocities

Library: Computer Vision Toolbox / Analysis & Enhancement

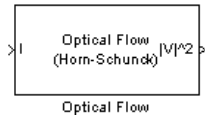

Description

The Optical Flow block estimates the direction and speed of object motion between two images or between one video frame to another frame using either the Horn-Schunck or the Lucas-Kanade method.

Ports

Input

I/I1 — Image or video frame

scalar | vector | matrix

Image or video frame, specified as a scalar, vector, or matrix. If the **Compute optical flow between** parameter is set to **Two images**, the name of this port changes to **I1**.

Data Types: single | double | int8 | int16 | int32 | int64 | uint8 | uint16 | uint32 | uint64 | fixed point

I2 — Image

scalar | vector | matrix

Image or video frame, specified as a scalar, vector, or matrix.

Data Types: single | double | int8 | int16 | int32 | int64 | uint8 | uint16 | uint32 | uint64 | fixed point

Output

|V|^2 — Velocity magnitudes

scalar | vector | matrix

Velocity magnitudes, returned as a scalar, vector, or matrix.

Data Types: single | double | int8 | int16 | int32 | int64 | uint8 | uint16 | uint32 | uint64 | fixed point

V — Velocity components in complex form

scalar | vector | matrix

Velocity components in complex form, specified as a scalar, vector, or matrix.

Dependencies

To enable this port, set the **Velocity output** parameter to `Horizontal` and `vertical` components in complex form.

Data Types: `single` | `double` | `int8` | `int16` | `int32` | `int64` | `uint8` | `uint16` | `uint32` | `uint64` | `fixed point`

Parameters**Main Tab****Method — Optical flow calculation method**

`Horn-Schunck` (default) | `Lucas-Kanade`

Select the method to use to calculate the optical flow. Options include `Horn-Schunck` or `Lucas-Kanade`.

Compute optical flow between — Compute optical flow

`Current frame and N-th frame back` (default) | `Two images`

Select how to compute the optical flow. Select `Two images` to compute the optical flow between two images. Select `Current frame and N-th frame back` to compute the optical flow between two video frames that are N frames apart.

Dependencies

To enable this parameter, set the:

- **Method** parameter to `Horn-Schunck`
- **Method** parameter to `Lucas-Kanade` and the **Temporal gradient filter** to `Difference filter [-1 1]`

N — Number of frames

`1` (default) | `scalar`

Enter a scalar value that represents the number of frames between the reference frame and the current frame.

Dependencies

To enable this parameter, set the **Compute optical flow between** parameter to `Current frame and N-th frame back`.

Smoothness factor — Smoothness factor

`1` (default) | `positive scalar`

Specify the smoothness factor. Enter a large positive scalar value for high relative motion between the two images or video frames. Enter a small positive scalar value for low relative motion.

Dependencies

To enable this parameter, set the **Method** parameter to `Horn-Schunck`.

Stop iterative solution — Stop iterative solution

When maximum number of iterations is reached (default) | When velocity difference falls below threshold | Whichever comes first

Specify the method to control when the block's iterative solution process stops. If you want the process to stop when the velocity difference is below a certain threshold value, select `When velocity difference falls below threshold`. If you want the process to stop after a certain number of iterations, choose `When maximum number of iterations is reached`. You can also select `Whichever comes first`.

Dependencies

To enable this parameter, set the **Method** parameter to Horn-Schunck.

Maximum number of iterations — Maximum number of iterations

10 (default) | scalar

Specify the maximum number of iterations for the block to perform.

Dependencies

To enable this parameter, set the **Method** parameter to Horn-Schunck and the **Stop iterative solution** parameter to `When maximum number of iterations is reached` or `Whichever comes first`.

Velocity output — Optical flow output

Magnitude-squared (default) | Horizontal and vertical components in complex form

Specify how to output an optical flow. If you select `Magnitude-squared`, the block outputs an optical flow matrix where each element is in the form $u^2 + v^2$. If you select `Horizontal and vertical components in complex form`, the block outputs the optical flow matrix where each element is in the form $u + jv$.

Temporal gradient filter — Filter used for temporal gradient

Difference filter [-1 1] (default) | Derivative of Gaussian

Specify whether the block solves for u and v using a difference filter or a derivative of a Gaussian filter.

Dependencies

To enable this parameter, set the **Method** parameter to Lucas-Kanade.

Number of input frames to buffer — Number of input frames to buffer for smoothing

3 (default) | scalar

Specify the number of input frames to buffer for smoothing. Use this parameter for temporal filter characteristics such as the standard deviation and number of filter coefficients.

Dependencies

To enable this parameter, set the **Temporal gradient filter** parameter to `Derivative of Gaussian`.

Standard deviation for image smoothing filter — Standard deviation for image smoothing filter

1.5 (default) | scalar

Specify the standard deviation for the image smoothing filter.

Dependencies

To enable this parameter, set the **Temporal gradient filter** parameter to Derivative of Gaussian.

Standard deviation for gradient smoothing filter – Standard deviation for gradient smoothing filter

1 (default) | scalar

Specify the standard deviation for the gradient smoothing filter.

Dependencies

To enable this parameter, set the **Temporal gradient filter** parameter to Derivative of Gaussian.

Discard normal flow estimates when constraint equation is ill-conditioned – Discard normal flow estimates

off (default) | on

Select this parameter to set the motion vector to zero when the optical flow constraint equation is ill-conditioned.

Dependencies

To enable this parameter, set the **Temporal gradient filter** parameter to Derivative of Gaussian.

Output image corresponding to motion vectors (accounts for block delay) – Output image corresponding to motion vectors

off (default) | on

Select this parameter to output the image that corresponds to the motion vector outputted by the block.

Dependencies

To enable this parameter, set the **Temporal gradient filter** parameter to Derivative of Gaussian.

Threshold for noise reduction – Threshold for noise reduction

0.0039 (default) | scalar

Specify a scalar value that determines the motion threshold between each image or video frame. The higher the number, the less small movements impact the optical flow calculation.

Dependencies

To enable this parameter, set the **Method** parameter to Lucas-Kanade.

Data Types Tab

For details on the fixed-point block parameters, see “Specify Fixed-Point Attributes for Blocks”.

Block Characteristics

Data Types	double single
Multidimensional Signals	no
Variable-Size Signals	no

Algorithms

Optical Flow Equation

To compute the optical flow between two images, you must solve this optical flow constraint equation:

$$I_x u + I_y v + I_t = 0$$

- I_x , I_y , and I_t are the spatiotemporal image brightness derivatives.
- u is the horizontal optical flow.
- v is the vertical optical flow.

Horn-Schunck Method

By assuming that the optical flow is smooth across the entire image, the Horn-Schunck method estimates a velocity field, $[u \ v]^T$, that minimizes this equation:

$$E = \iint (I_x u + I_y v + I_t)^2 dx dy + \alpha \iint \left\{ \left(\frac{\partial u}{\partial x} \right)^2 + \left(\frac{\partial u}{\partial y} \right)^2 + \left(\frac{\partial v}{\partial x} \right)^2 + \left(\frac{\partial v}{\partial y} \right)^2 \right\} dx dy$$

In this equation, $\frac{\partial u}{\partial x}$ and $\frac{\partial u}{\partial y}$ are the spatial derivatives of the optical velocity component, u , and α scales the global smoothness term. The Horn-Schunck method minimizes the previous equation to obtain the velocity field, $[u \ v]$, for each pixel in the image. This method is given by the following equations:

$$u_{x,y}^{k+1} = \bar{u}_{x,y}^k - \frac{I_x [I_x \bar{u}_{x,y}^k + I_y \bar{v}_{x,y}^k + I_t]}{\alpha^2 + I_x^2 + I_y^2}$$

$$v_{x,y}^{k+1} = \bar{v}_{x,y}^k - \frac{I_y [I_x \bar{u}_{x,y}^k + I_y \bar{v}_{x,y}^k + I_t]}{\alpha^2 + I_x^2 + I_y^2}$$

In these equations, $[u_{x,y}^k \ v_{x,y}^k]$ is the velocity estimate for the pixel at (x,y) , and $[\bar{u}_{x,y}^k \ \bar{v}_{x,y}^k]$ is the neighborhood average of $[u_{x,y}^k \ v_{x,y}^k]$. For $k = 0$, the initial velocity is 0.

To solve u and v using the Horn-Schunck method:

- 1 Compute I_x and I_y by using the Sobel convolution kernel, $[-1 \ -2 \ -1; 0 \ 0 \ 0; 1 \ 2 \ 1]$, and its transposed form for each pixel in the first image.
- 2 Compute I_t between images 1 and 2 using the $[-1 \ 1]$ kernel.
- 3 Assume the previous velocity to be 0, and compute the average velocity for each pixel using $[0 \ 1 \ 0; 1 \ 0 \ 1; 0 \ 1 \ 0]$ as a convolution kernel.
- 4 Iteratively solve for u and v .

Lucas-Kanade Method

To solve the optical flow constraint equation for u and v , the Lucas-Kanade method divides the original image into smaller sections and assumes a constant velocity in each section. Then it performs a weighted, least-square fit of the optical flow constraint equation to a constant model for $[u \ v]^T$ in each section Ω . The method achieves this fit by minimizing this equation:

$$\sum_{x \in \Omega} W^2 [I_x u + I_y v + I_t]^2$$

W is a window function that emphasizes the constraints at the center of each section. The solution to the minimization problem is

$$\begin{bmatrix} \sum W^2 I_x^2 & \sum W^2 I_x I_y \\ \sum W^2 I_y I_x & \sum W^2 I_y^2 \end{bmatrix} \begin{bmatrix} u \\ v \end{bmatrix} = - \begin{bmatrix} \sum W^2 I_x I_t \\ \sum W^2 I_y I_t \end{bmatrix}$$

Lucas-Kanade Difference Filter

When you set the **Temporal gradient filter** to Difference filter $[-1 \ 1]$, u and v are solved as follows:

- 1 Compute I_x and I_y using the kernel $[-1 \ 8 \ 0 \ -8 \ 1]/12$ and its transposed form.

If you are working with fixed-point data types, the kernel values are signed fixed-point values with a word length equal to 16 and a fraction length equal to 15.

- 2 Compute I_t between images 1 and 2 by using the $[-1 \ 1]$ kernel.
- 3 Smooth the gradient components, I_x , I_y , and I_t , by using a separable and isotropic 5-by-5 element kernel whose effective 1-D coefficients are $[1 \ 4 \ 6 \ 4 \ 1]/16$. If you are working with fixed-point data types, the kernel values are unsigned fixed-point values with a word length equal to 8 and a fraction length equal to 7.
- 4 Solve the 2-by-2 linear equations for each pixel using the following method:

$$\bullet \text{ If } A = \begin{bmatrix} a & b \\ b & c \end{bmatrix} = \begin{bmatrix} \sum W^2 I_x^2 & \sum W^2 I_x I_y \\ \sum W^2 I_y I_x & \sum W^2 I_y^2 \end{bmatrix}$$

$$\text{then the eigenvalues of } A \text{ are } \lambda_i = \frac{a+c}{2} \pm \frac{\sqrt{4b^2 + (a-c)^2}}{2}; i = 1, 2$$

$$\text{In the fixed-point diagrams, } P = \frac{a+c}{2}, Q = \frac{\sqrt{4b^2 + (a-c)^2}}{2}$$

- The eigenvalues are compared to the threshold, τ , that corresponds to the value you enter for the threshold for noise reduction. The results fall into one of the following cases.

Case 1: $\lambda_1 \geq \tau$ and $\lambda_2 \geq \tau$

A is nonsingular, and the system of equations is solved using Cramer's rule.

Case 2: $\lambda_1 \geq \tau$ and $\lambda_2 < \tau$

A is singular (noninvertible), and the gradient flow is normalized to calculate u and v .

Case 3: $\lambda_1 < \tau$ and $\lambda_2 < \tau$

The optical flow, u and v , is 0.

Derivative of Gaussian

If you set the temporal gradient filter to **Derivative of Gaussian**, u and v are solved using these steps.

- Compute I_x and I_y .
 - Use a Gaussian filter to perform temporal filtering. Specify the temporal filter characteristics, such as the standard deviation and number of filter coefficients, by using the **Number of frames to buffer for temporal smoothing** parameter.
 - Use a Gaussian filter and the derivative of a Gaussian filter to smooth the image by using spatial filtering. Specify the standard deviation and length of the image smoothing filter by using the **Standard deviation for image smoothing filter** parameter.
- Compute I_t between images 1 and 2.
 - Use the derivative of a Gaussian filter to perform temporal filtering. Specify the temporal filter characteristics, such as the standard deviation and number of filter coefficients, by using the **Number of frames to buffer for temporal smoothing** parameter.
 - Use the filter described in step 1b to perform spatial filtering on the output of the temporal filter.
- Smooth the gradient components, I_x , I_y , and I_t , by using a gradient smoothing filter. Use the **Standard deviation for gradient smoothing filter** parameter to specify the standard deviation and the number of filter coefficients for the gradient smoothing filter.
- Solve the 2-by-2 linear equations for each pixel using this method:

$$\text{If } A = \begin{bmatrix} a & b \\ b & c \end{bmatrix} = \begin{bmatrix} \sum W^2 I_x^2 & \sum W^2 I_x I_y \\ \sum W^2 I_y I_x & \sum W^2 I_y^2 \end{bmatrix}$$

then the eigenvalues of A are $\lambda_i = \frac{a+c}{2} \pm \frac{\sqrt{4b^2 + (a-c)^2}}{2}; i = 1, 2$

- When the block finds the eigenvalues, it compares them to the threshold, τ , that corresponds to the value you enter for the **Threshold for noise reduction** parameter. The results fall into one of the following cases.

Case 1: $\lambda_1 \geq \tau$ and $\lambda_2 \geq \tau$

A is nonsingular, so the block solves the system of equations by using Cramer's rule.

Case 2: $\lambda_1 \geq \tau$ and $\lambda_2 < \tau$

A is singular (noninvertible), so the block normalizes the gradient flow to calculate u and v .

Case 3: $\lambda_1 < \tau$ and $\lambda_2 < \tau$

the optical flow, u and v , is 0.

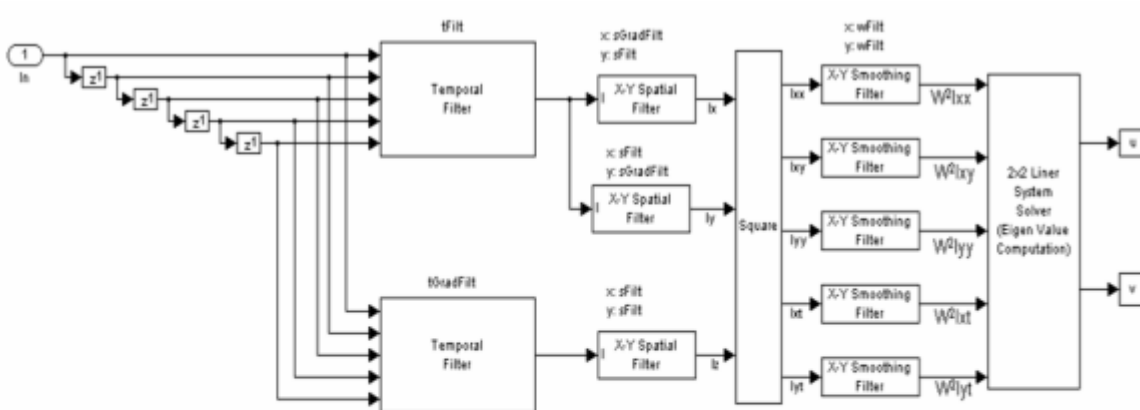

tFilt = Coefficients of Gaussian Filter
tGradFilt = Coefficients of the Derivative of a Gaussian Filter

sFilt = Coefficients of Gaussian Filter
sGradFilt = Coefficients of the Derivative of a Gaussian Filter

Extended Capabilities

C/C++ Code Generation

Generate C and C++ code using Simulink® Coder™.

Fixed-Point Conversion

Design and simulate fixed-point systems using Fixed-Point Designer™.

See Also

Block Matching | Gaussian Pyramid | opticalFlow | opticalFlowHS | opticalFlowLK | opticalFlowLKDoG

Introduced before R2006a

PSNR

Compute peak signal-to-noise ratio (PSNR) between images

Library: Computer Vision Toolbox / Statistics

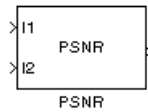

Description

The PSNR block computes the peak signal-to-noise ratio, in decibels, between two images. This ratio is used as a quality measurement between the original and a compressed image. The higher the PSNR, the better the quality of the compressed, or reconstructed image.

The mean-square error (MSE) and the peak signal-to-noise ratio (PSNR) are used to compare image compression quality. The MSE represents the cumulative squared error between the compressed and the original image, whereas PSNR represents a measure of the peak error. The lower the value of MSE, the lower the error.

To compute the PSNR, the block first calculates the mean-squared error using the following equation:

$$MSE = \frac{\sum_{M,N} [I_1(m,n) - I_2(m,n)]^2}{M * N}$$

In the previous equation, M and N are the number of rows and columns in the input images. Then the block computes the PSNR using the following equation:

$$PSNR = 10 \log_{10} \left(\frac{R^2}{MSE} \right)$$

In the previous equation, R is the maximum fluctuation in the input image data type. For example, if the input image has a double-precision floating-point data type, then R is 1. If it has an 8-bit unsigned integer data type, R is 255, etc.

Computing PSNR for Color Images

Different approaches exist for computing the PSNR of a color image. Because the human eye is most sensitive to luma information, you can compute the PSNR for color images by converting the image to a color space that separates the intensity (luma) channel, such as YCbCr. The Y (luma), in YCbCr represents a weighted average of R, G, and B. G is given the most weight, again because the human eye perceives it most easily. Compute the PSNR only on the luma channel.

Ports

Input

I1 — Input image

scalar | vector | matrix

Input image, specified as scalar, vector, or matrix.

Data Types: `single` | `double` | `int8` | `int16` | `int32` | `int64` | `uint8` | `uint16` | `uint32` | `uint64` | `Boolean` | `fixed point`

I2 – Input image

`scalar` | `vector` | `matrix`

Input image, specified as scalar, vector, or matrix.

Data Types: `single` | `double` | `int8` | `int16` | `int32` | `int64` | `uint8` | `uint16` | `uint32` | `uint64` | `Boolean` | `fixed point`

Output

Output – Output

`scalar`

Peak signal-to-noise ratio between images, returned as a scalar.

Dependencies

If the input is a fixed-point or integer data type, the block output is double-precision floating point. Otherwise, the block input and output are the same data type.

Data Types: `double`

Block Characteristics

Data Types	<code>double</code> <code>fixed point</code> <code>integer</code> <code>single</code>
Multidimensional Signals	<code>no</code>
Variable-Size Signals	<code>yes</code>

Extended Capabilities

C/C++ Code Generation

Generate C and C++ code using Simulink® Coder™.

Generates code only for `double` or `single` data types.

Fixed-Point Conversion

Design and simulate fixed-point systems using Fixed-Point Designer™.

See Also

`psnr`

Introduced before R2006a

Resize

Enlarge or shrink image sizes



Library

Geometric Transformations

visiongeotforms

Description

The Resize block enlarges or shrinks an image by resizing the image along one dimension (row or column). Then, it resizes the image along the other dimension (column or row).

This block supports intensity and color images on its ports. When you input a floating point data type signal, the block outputs the same data type.

Shrinking an image can introduce high frequency components into the image and aliasing might occur. If you select the **Perform antialiasing when resize factor is between 0 and 100** check box, the block performs low pass filtering on the input image before shrinking it.

Port Description

Port	Input/Output	Supported Data Types	Complex Values Supported
Image / Input	M -by- N matrix of intensity values or an M -by- N -by- P color video signal where P is the number of color planes	<ul style="list-style-type: none"> • Double-precision floating point • Single-precision floating point • Fixed point • 8-, 16-, 32-bit signed integer • 8-, 16-, 32-bit unsigned integer 	No
ROI	Four-element vector [x y width height] that defines the ROI	<ul style="list-style-type: none"> • Double-precision floating point (only supported if the input to the Input port is floating point) • Single-precision floating point (only supported if the input to the Input port is floating point) • 8-, 16-, 32-bit signed integer • 8-, 16-, 32-bit unsigned integer 	No
Output	Resized image	Same as Input port	No

Port	Input/Output	Supported Data Types	Complex Values Supported
Flag	Boolean value that indicates whether the ROI is within the image bounds	Boolean	No

ROI Processing

To resize a particular region of each image, select the **Enable ROI processing** check box. To enable this option, select the following parameter values.

- **Specify** = Number of output rows and columns
- **Interpolation method** = Nearest neighbor, Bilinear, or Bicubic
- Clear the **Perform antialiasing when resize factor is between 0 and 100** check box.

If you select the **Enable ROI processing** check box, the ROI port appears on the block. Use this port to define a region of interest (ROI) in the input matrix, that you want to resize. The input to this port must be a four-element vector, [x y width height]. The first two elements define the upper-left corner of the ROI, and the second two elements define the width and height of the ROI.

If you select the **Enable ROI processing** check box, the **Output flag indicating if any part of ROI is outside image bounds** check box appears in the dialog box. If you select this check box, the Flag port appears on the block. The following tables describe the Flag port output.

Flag Port Output	Description
0	ROI is completely inside the input image.
1	ROI is completely or partially outside the input image.

Fixed-Point Data Types

The following diagram shows the data types used in the Resize block for fixed-point signals.

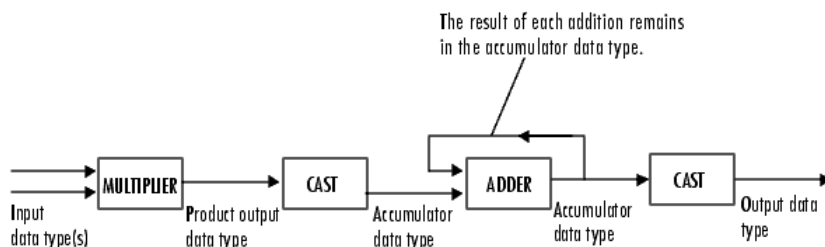

You can set the interpolation weights table, product output, accumulator, and output data types in the block mask.

Parameters

Specify

Specify which aspects of the image to resize. Your choices are Output size as a percentage of input size, Number of output columns and preserve aspect ratio, Number of output rows and preserve aspect ratio, or Number of output rows and columns.

When you select Output size as a percentage of input size, the **Resize factor in percentage** parameter appears in the dialog box. Enter a scalar percentage value that is applied to both rows and columns.

When you select Number of output columns and preserve aspect ratio, the **Number of output columns** parameter appears in the dialog box. Enter a scalar value that represents the number of columns you want the output image to have. The block calculates the number of output rows so that the output image has the same aspect ratio as the input image.

When you select Number of output rows and preserve aspect ratio, the **Number of output rows** parameter appears in the dialog box. Enter a scalar value that represents the number of rows you want the output image to have. The block calculates the number of output columns so that the output image has the same aspect ratio as the input image.

When you select Number of output rows and columns, the **Number of output rows and columns** parameter appears in the dialog box. Enter a two-element vector, where the first element is the number of rows in the output image and the second element is the number of columns. In this case, the aspect ratio of the image can change.

Resize factor in percentage

Enter a scalar percentage value that is applied to both rows and columns or a two-element vector, where the first element is the percentage by which to resize the rows and the second element is the percentage by which to resize the columns. This parameter is visible if, for the **Specify** parameter, you select Output size as a percentage of input size.

You must enter a scalar value that is greater than zero. The table below describes the affect of the resize factor value:

Resize factor in percentage	Resizing of image
$0 < \text{resize factor} < 100$	The block shrinks the image.
resize factor = 100	Image unchanged.
resize factor > 100	The block enlarges the image.

The dimensions of the output matrix depend on the **Resize factor in percentage** parameter and are given by the following equations:

$$\text{number_output_rows} = \text{round}(\text{number_input_rows} * \text{resize_factor} / 100); \quad (1-1)$$

$$\text{number_output_cols} = \text{round}(\text{number_input_cols} * \text{resize_factor} / 100); \quad (1-2)$$

Number of output columns

Enter a scalar value that represents the number of columns you want the output image to have. This parameter is visible if, for the **Specify** parameter, you select Number of output columns and preserve aspect ratio.

Number of output rows

Enter a scalar value that represents the number of rows you want the output image to have. This parameter is visible if, for the **Specify** parameter, you select **Number of output rows and preserve aspect ratio**.

Number of output rows and columns

Enter a two-element vector, where the first element is the number of rows in the output image and the second element is the number of columns. This parameter is visible if, for the **Specify** parameter, you select **Number of output rows and columns**.

Interpolation method

Specify which interpolation method to resize the image.

When you select **Nearest neighbor**, the block uses one nearby pixel to interpolate the pixel value. This option though the most efficient, is the least accurate. When you select **Bilinear**, the block uses four nearby pixels to interpolate the pixel value. When you select **Bicubic** or **Lanczos2**, the block uses 16 nearby pixels to interpolate the pixel value. When you select **Lanczos3**, the block uses 36 surrounding pixels to interpolate the pixel value.

The Resize block performs optimally when you set this parameter to **Nearest neighbor** with one of the following conditions:

- You set the **Resize factor in percentage** parameter to a multiple of 100.
- Dividing 100 by the **Resize factor in percentage** parameter value results in an integer value.

Perform antialiasing when resize factor is between 0 and 100

If you select this check box, the block performs low-pass filtering on the input image before shrinking it to prevent aliasing.

Enable ROI processing

Select this check box to resize a particular region of each image. This parameter is available when the **Specify** parameter is set to **Number of output rows and columns**, the **Interpolation method** parameter is set to **Nearest neighbor**, **Bilinear**, or **Bicubic**, and the **Perform antialiasing when resize factor is between 0 and 100** check box is not selected.

Output flag indicating if any part of ROI is outside image bounds

If you select this check box, the Flag port appears on the block. The block outputs 1 at this port if the ROI is completely or partially outside the input image. Otherwise, it outputs 0.

Rounding mode

Select the rounding mode for fixed-point operations.

Overflow mode

Select the overflow mode for fixed-point operations.

Interpolation weights table

Choose how to specify the word length of the values of the interpolation weights table. The fraction length of the interpolation weights table values is always equal to the word length minus one:

- When you select **Same as input**, the word length of the interpolation weights table values match that of the input to the block.
- When you select **Binary point scaling**, you can enter the word length of the interpolation weights table values, in bits.

- When you select **Slope and bias scaling**, you can enter the word length of the interpolation weights table values, in bits.

Product output



As depicted in the preceding diagram, the output of the multiplier is placed into the product output data type and scaling. Use this parameter to specify how to designate this product output word and fraction lengths.

- When you select **Same as input**, these characteristics match those of the input to the block.
- When you select **Binary point scaling**, you can enter the word length and the fraction length of the product output, in bits.
- When you select **Slope and bias scaling**, you can enter the word length, in bits, and the slope of the product output. The bias of all signals in the Computer Vision Toolbox blocks is 0.

Accumulator

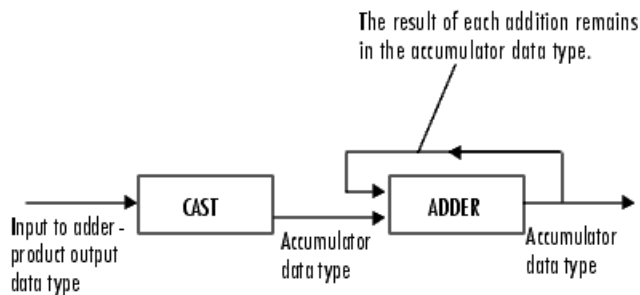

As depicted in the preceding diagram, inputs to the accumulator are cast to the accumulator data type. The output of the adder remains in the accumulator data type as each element of the input is added to it. Use this parameter to specify how to designate this accumulator word and fraction lengths.

- When you select **Same as product output**, these characteristics match those of the product output.
- When you select **Same as input**, these characteristics match those of the input to the block.
- When you select **Binary point scaling**, you can enter the word length and the fraction length of the accumulator, in bits.
- When you select **Slope and bias scaling**, you can enter the word length, in bits, and the slope of the accumulator. The bias of all signals in the Computer Vision Toolbox blocks is 0.

Output

Choose how to specify the word length and fraction length of the output of the block:

- When you select `Same as input`, these characteristics match those of the input to the block.
- When you select `Binary point scaling`, you can enter the word length and the fraction length of the output, in bits.
- When you select `Slope and bias scaling`, you can enter the word length, in bits, and the slope of the output. The bias of all signals in the Computer Vision Toolbox blocks is 0.

Lock data type settings against change by the fixed-point tools

Select this parameter to prevent the fixed-point tools from overriding the data types you specify on the block mask. For more information, see `fxptdlg`, a reference page on the Fixed-Point Tool in the Simulink documentation.

References

- [1] Ward, Joseph and David R. Cok. "Resampling Algorithms for Image Resizing and Rotation", *Proc. SPIE Digital Image Processing Applications*, vol. 1075, pp. 260-269, 1989.
- [2] Wolberg, George. *Digital Image Warping*. Washington: IEEE Computer Society Press, 1990.

Extended Capabilities

C/C++ Code Generation

Generate C and C++ code using Simulink® Coder™.

See Also

`imresize` | `Translate` | `Shear` | `Rotate`

Introduced before R2006a

Rotate

Rotate image by specified angle

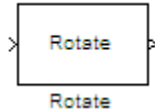

Library

Geometric Transformations

visiongeotforms

Description

Use the Rotate block to rotate an image by an angle specified in radians.

Note This block supports intensity and color images on its ports.

Port	Description
Image	M-by-N matrix of intensity values or an M-by-N-by-P color video signal where P is the number of color planes
Angle	Rotation angle
Output	Rotated matrix

The Rotate block uses the 3-pass shear rotation algorithm to compute its values, which is different than the algorithm used by the `imrotate` function in the Image Processing Toolbox.

Fixed-Point Data Types

The following diagram shows the data types used in the Rotate block for bilinear interpolation of fixed-point signals.

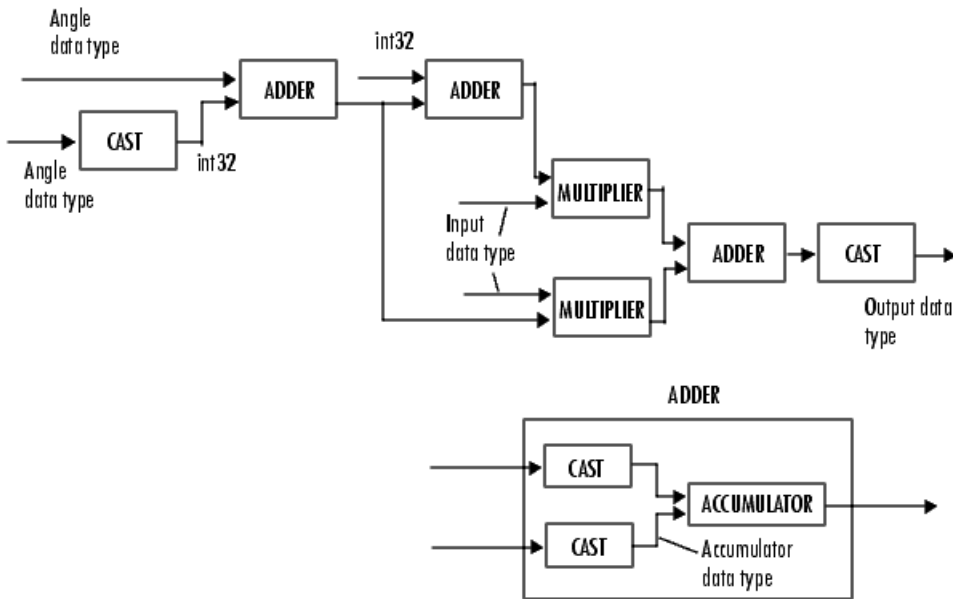

You can set the angle values, product output, accumulator, and output data types in the block mask.

The Rotate block requires additional data types. The Sine table value has the same word length as the angle data type and a fraction length that is equal to its word length minus one. The following diagram shows how these data types are used inside the block.

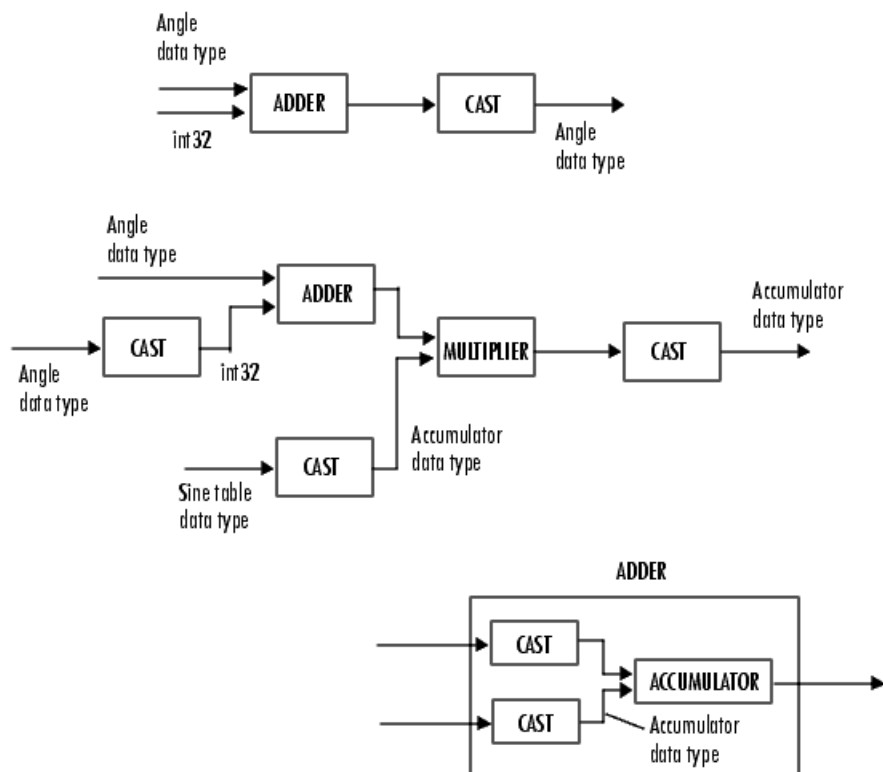

Note If overflow occurs, the rotated image might appear distorted.

Parameters

Output size

Specify the size of the rotated matrix. If you select **Expanded to fit rotated input image**, the block outputs a matrix that contains all the rotated image values. If you select **Same as input image**, the block outputs a matrix that contains the middle part of the rotated image. As a result, the edges of the rotated image might be cropped. Use the **Background fill value** parameter to specify the pixel values outside the image.

Rotation angle source

Specify how to enter your rotation angle. If you select **Specify via dialog**, the **Angle (radians)** parameter appears in the dialog box.

If you select **Input port**, the Angle port appears on the block. The block uses the input to this port at each time step as your rotation angle. The input to the Angle port must be the same data type as the input to the **I** port.

Angle (radians)

Enter a real, scalar value for your rotation angle. This parameter is visible if, for the **Rotation angle source** parameter, you select **Specify via dialog**.

When the rotation angle is a multiple of $\pi/2$, the block uses a more efficient algorithm. If the angle value you enter for the **Angle (radians)** parameter is within 0.00001 radians of a multiple of $\pi/2$, the block rounds the angle value to the multiple of $\pi/2$ before performing the rotation.

Maximum angle (enter pi radians to accommodate all positive and negative angles)

Enter the maximum angle by which to rotate the input image. Enter a scalar value, between 0 and π radians. The block determines which angle, $0 \leq \text{angle} \leq \text{maxangle}$, requires the largest output matrix and sets the dimensions of the output port accordingly.

This parameter is visible if you set the **Output size** parameter, to **Expanded to fit rotated input image**, and the **Rotation angle source** parameter to **Input port**.

Display rotated image in

Specify how the image is rotated. If you select **Center**, the image is rotated about its center point. If you select **Top-left corner**, the block rotates the image so that two corners of the rotated input image are always in contact with the top and left sides of the output image.

This parameter is visible if, for the **Output size** parameter, you select **Expanded to fit rotated input image**, and, for the **Rotation angle source** parameter, you select **Input port**.

Sine value computation method

Specify the value computation method. If you select **Trigonometric function**, the block computes sine and cosine values it needs to calculate the rotation of your image during the simulation. If you select **Table lookup**, the block computes and stores the trigonometric values it needs to calculate the rotation of your image before the simulation starts. In this case, the block requires extra memory.

Background fill value

Specify a value for the pixels that are outside the image.

Interpolation method

Specify which interpolation method the block uses to translate the image. If you select **Nearest neighbor**, the block uses the value of one nearby pixel for the new pixel value. If you select **Bilinear**, the new pixel value is the weighted average of the four nearest pixel values. If you select **Bicubic**, the new pixel value is the weighted average of the sixteen nearest pixel values.

The number of pixels the block considers affects the complexity of the computation. Therefore, the **Nearest-neighbor** interpolation is the most computationally efficient. However, because the accuracy of the method is proportional to the number of pixels considered, the **Bicubic** method is the most accurate.

Rounding mode

Select the rounding mode for fixed-point operations.

Overflow mode

Select the overflow mode for fixed-point operations.

Angle values

Choose how to specify the word length and the fraction length of the angle values.

- When you select **Same word length as input**, the word length of the angle values match that of the input to the block. In this mode, the fraction length of the angle values is automatically set to the binary-point only scaling that provides you with the best precision possible given the value and word length of the angle values.
- When you select **Specify word length**, you can enter the word length of the angle values, in bits. The block automatically sets the fraction length to give you the best precision.
- When you select **Binary point scaling**, you can enter the word length and the fraction length of the angle values, in bits.
- When you select **Slope and bias scaling**, you can enter the word length, in bits, and the slope of the angle values. The bias of all signals in the Computer Vision Toolbox blocks is 0.

This parameter is only visible if, for the **Rotation angle source** parameter, you select **Specify via dialog**.

Product output



As depicted in the previous figure, the output of the multiplier is placed into the product output data type and scaling. Use this parameter to specify how to designate this product output word and fraction lengths.

- When you select **Same as first input**, these characteristics match those of the input to the block.
- When you select **Binary point scaling**, you can enter the word length and the fraction length of the product output, in bits.

- When you select `Slope and bias scaling`, you can enter the word length, in bits, and the slope of the product output. The bias of all signals in the Computer Vision Toolbox blocks is 0.

Accumulator

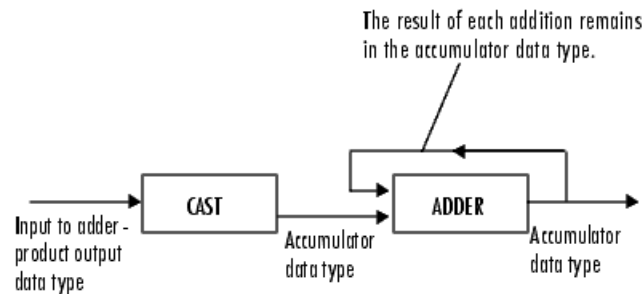

As depicted in the previous figure, inputs to the accumulator are cast to the accumulator data type. The output of the adder remains in the accumulator data type as each element of the input is added to it. Use this parameter to specify how to designate this accumulator word and fraction lengths.

- When you select `Same as product output`, these characteristics match those of the product output.
- When you select `Same as first input`, these characteristics match those of the first input to the block.
- When you select `Binary point scaling`, you can enter the word length and the fraction length of the accumulator, in bits.
- When you select `Slope and bias scaling`, you can enter the word length, in bits, and the slope of the accumulator. The bias of all signals in the Computer Vision Toolbox blocks is 0.

Output

Choose how to specify the word length and fraction length of the output of the block:

- When you select `Same as first input`, these characteristics match those of the first input to the block.
- When you select `Binary point scaling`, you can enter the word length and the fraction length of the output, in bits.
- When you select `Slope and bias scaling`, you can enter the word length, in bits, and the slope of the output. The bias of all signals in the Computer Vision Toolbox blocks is 0.

Lock data type settings against change by the fixed-point tools

Select this parameter to prevent the fixed-point tools from overriding the data types you specify on the block mask. For more information, see `fxptdlg`, a reference page on the Fixed-Point Tool in the Simulink documentation.

Supported Data Types

Port	Supported Data Types
Image	<ul style="list-style-type: none"> • Double-precision floating point • Single-precision floating point • Fixed point • 8-, 16-, 32-bit signed integer • 8-, 16-, 32-bit unsigned integer
Angle	Same as Image port
Output	Same as Image port

If the data type of the input signal is floating point, the output signal is the same data type as the input signal.

References

[1] Wolberg, George. *Digital Image Warping*. Washington: IEEE Computer Society Press, 1990.

See Also

Resize	Computer Vision Toolbox software
Translate	Computer Vision Toolbox software
Shear	Computer Vision Toolbox software
imrotate	Image Processing Toolbox software

More About

Nearest Neighbor Interpolation Method

For nearest neighbor interpolation, the block uses the value of nearby translated pixel values for the output pixel values.

For example, suppose this matrix,

```

1 2 3
4 5 6
7 8 9

```

represents your input image. You want to translate this image 1.7 pixels in the positive horizontal direction using nearest neighbor interpolation. The block's nearest neighbor interpolation algorithm is illustrated by the following steps:

- 1 Zero pad the input matrix and translate it by 1.7 pixels to the right.

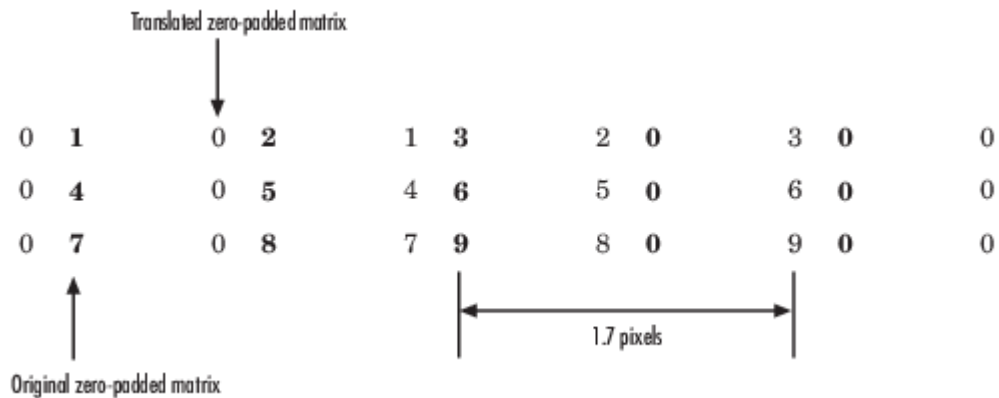

- 2 Create the output matrix by replacing each input pixel value with the translated value nearest to it. The result is the following matrix:

```
0 0 1 2 3
0 0 4 5 6
0 0 7 8 9
```

Note You wanted to translate the image by 1.7 pixels, but this method translated the image by 2 pixels. Nearest neighbor interpolation is computationally efficient but not as accurate as bilinear or bicubic interpolation methods.

Bilinear Interpolation

For bilinear interpolation, the block uses the weighted average of two translated pixel values for each output pixel value.

For example, suppose this matrix,

```
1 2 3
4 5 6
7 8 9
```

represents your input image. You want to translate this image 0.5 pixel in the positive horizontal direction using bilinear interpolation. The block's bilinear interpolation algorithm is illustrated by the following steps:

- 1 Zero pad the input matrix and translate it by 0.5 pixel to the right.

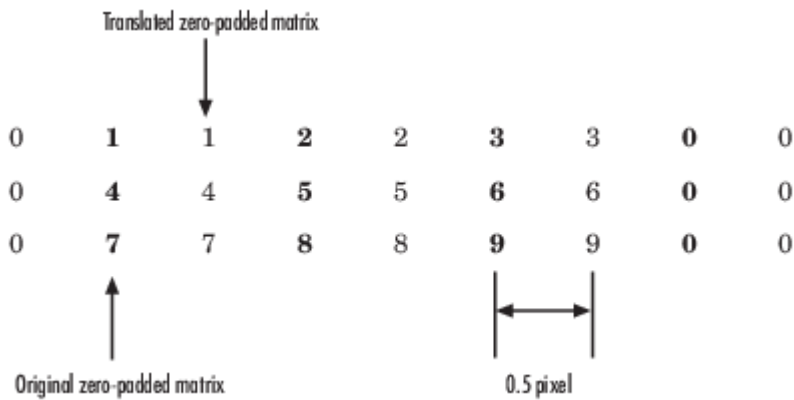

- 2 Create the output matrix by replacing each input pixel value with the weighted average of the translated values on either side. The result is the following matrix where the output matrix has one more column than the input matrix:

```
0.5 1.5 2.5 1.5
 2  4.5 5.5  3
3.5 7.5 8.5 4.5
```

Bicubic Interpolation

For bicubic interpolation, the block uses the weighted average of four translated pixel values for each output pixel value.

For example, suppose this matrix,

```
1 2 3
4 5 6
7 8 9
```

represents your input image. You want to translate this image 0.5 pixel in the positive horizontal direction using bicubic interpolation. The block's bicubic interpolation algorithm is illustrated by the following steps:

- 1 Zero pad the input matrix and translate it by 0.5 pixel to the right.

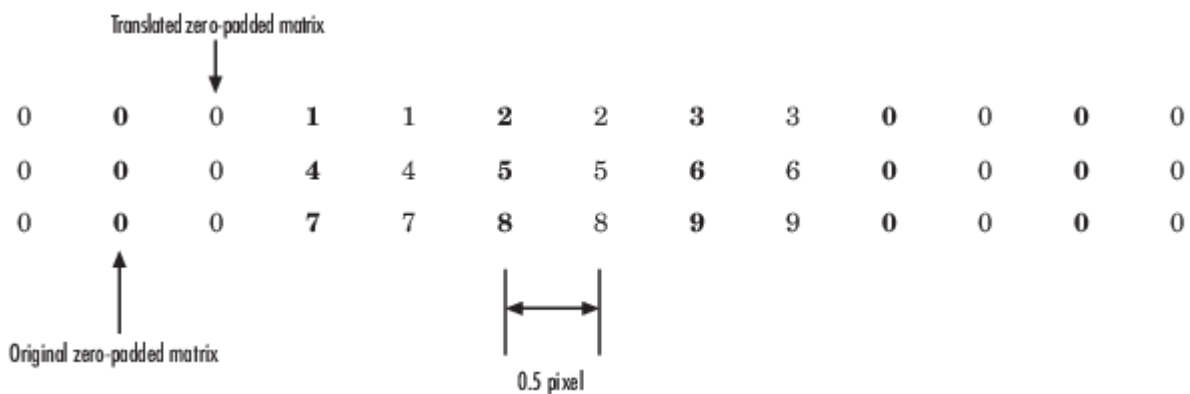

- 2** Create the output matrix by replacing each input pixel value with the weighted average of the two translated values on either side. The result is the following matrix where the output matrix has one more column than the input matrix:

```
0.375  1.5   3   1.625
1.875  4.875 6.375 3.125
3.375  8.25  9.75 4.625
```

Extended Capabilities

C/C++ Code Generation

Generate C and C++ code using Simulink® Coder™.

Introduced before R2006a

Shear

Shift rows or columns of image by linearly varying offset

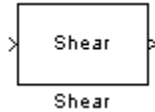

Library

Geometric Transformations

visiongeotforms

Description

The Shear block shifts the rows or columns of an image by a gradually increasing distance left or right or up or down.

Note This block supports intensity and color images on its ports.

Port	Input/Output	Supported Data Types	Complex Values Supported
Image	M-by-N matrix of intensity values or an M-by-N-by-P color video signal where P is the number of color planes	<ul style="list-style-type: none"> • Double-precision floating point • Single-precision floating point • Fixed point • 8-, 16-, 32-bit signed integer • 8-, 16-, 32-bit unsigned integer 	No
S	Two-element vector that represents the number of pixels by which you want to shift your first and last rows or columns	Same as I port	No
Output	Shifted image	Same as I port	No

If the data type of the input to the I port is floating point, the input to the S port of this block must be the same data type. Also, the block output is the same data type.

Use the **Shear direction** parameter to specify whether you want to shift the rows or columns. If you select **Horizontal**, the first row has an offset equal to the first element of the **Row/column shear values [first last]** vector. The following rows have an offset that linearly increases up to the value you enter for the last element of the **Row/column shear values [first last]** vector. If you select **Vertical**, the first column has an offset equal to the first element of the **Row/column shear values [first last]** vector. The following columns have an offset that linearly increases up to the value you enter for the last element of the **Row/column shear values [first last]** vector.

Use the **Output size after shear** parameter to specify the size of the sheared image. If you select `Full`, the block outputs a matrix that contains the entire sheared image. If you select `Same as input image`, the block outputs a matrix that is the same size as the input image and contains the top-left portion of the sheared image. Use the **Background fill value** parameter to specify the pixel values outside the image.

Use the **Shear values source** parameter to specify how to enter your shear parameters. If you select `Specify via dialog`, the **Row/column shear values [first last]** parameter appears in the dialog box. Use this parameter to enter a two-element vector that represents the number of pixels by which you want to shift your first and last rows or columns. For example, if for the **Shear direction** parameter you select `Horizontal` and, for the **Row/column shear values [first last]** parameter, you enter `[50 150]`, the block moves the top-left corner 50 pixels to the right and the bottom left corner of the input image 150 pixels to the right. If you want to move either corner to the left, enter negative values. If for the **Shear direction** parameter you select `Vertical` and, for the **Row/column shear values [first last]** parameter, you enter `[-10 50]`, the block moves the top-left corner 10 pixels up and the top right corner 50 pixels down. If you want to move either corner down, enter positive values.

Use the **Interpolation method** parameter to specify which interpolation method the block uses to shear the image. If you select `Nearest neighbor`, the block uses the value of the nearest pixel for the new pixel value. If you select `Bilinear`, the new pixel value is the weighted average of the two nearest pixel values. If you select `Bicubic`, the new pixel value is the weighted average of the four nearest pixel values.

The number of pixels the block considers affects the complexity of the computation. Therefore, the nearest-neighbor interpolation is the most computationally efficient. However, because the accuracy of the method is proportional to the number of pixels considered, the bicubic method is the most accurate.

If, for the **Shear values source** parameter, you select `Input port`, the S port appears on the block. At each time step, the input to the S port must be a two-element vector that represents the number of pixels by which to shift your first and last rows or columns.

If, for the **Output size after shear** parameter, you select `Full`, and for the **Shear values source** parameter, you select `Input port`, the **Maximum shear value** parameter appears in the dialog box. Use this parameter to enter a real, scalar value that represents the maximum number of pixels by which to shear your image. The block uses this parameter to determine the size of the output matrix. If any input to the S port is greater than the absolute value of the **Maximum shear value** parameter, the block saturates to the maximum value.

Fixed-Point Data Types

The following diagram shows the data types used in the Shear block for bilinear interpolation of fixed-point signals.

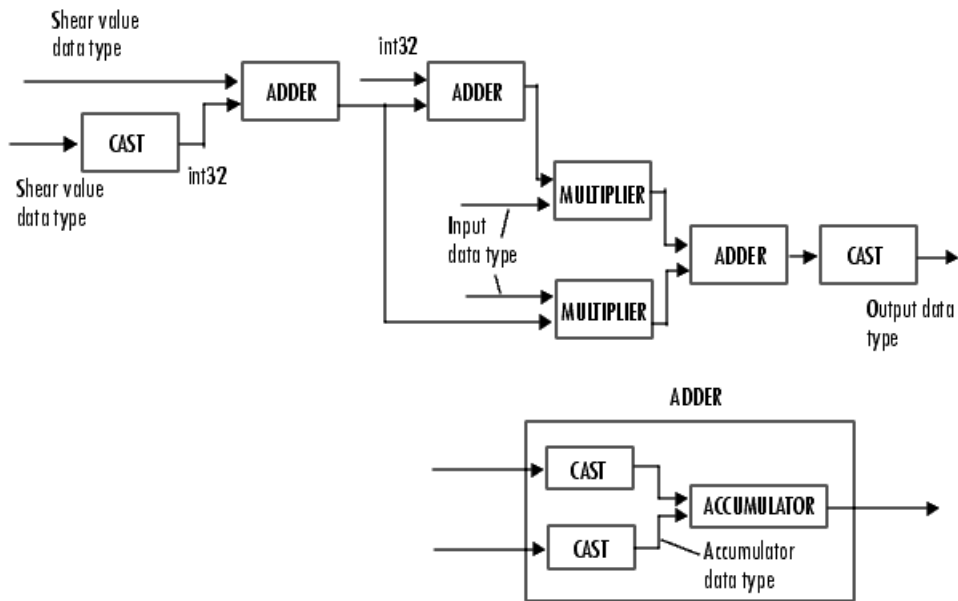

You can set the product output, accumulator, and output data types in the block mask.

Parameters

Shear direction

Specify whether you want to shift the rows or columns of the input image. Select **Horizontal** to linearly increase the offset of the rows. Select **Vertical** to steadily increase the offset of the columns.

Output size after shear

Specify the size of the sheared image. If you select **Full**, the block outputs a matrix that contains the sheared image values. If you select **Same as input image**, the block outputs a matrix that is the same size as the input image and contains a portion of the sheared image.

Shear values source

Specify how to enter your shear parameters. If you select **Specify via dialog**, the **Row/column shear values [first last]** parameter appears in the dialog box. If you select **Input port**, port S appears on the block. The block uses the input to this port at each time step as your shear value.

Row/column shear values [first last]

Enter a two-element vector that represents the number of pixels by which to shift your first and last rows or columns. This parameter is visible if, for the **Shear values source** parameter, you select **Specify via dialog**.

Maximum shear value

Enter a real, scalar value that represents the maximum number of pixels by which to shear your image. This parameter is visible if, for the **Shear values source** parameter, you select **Input port**.

Background fill value

Specify a value for the pixels that are outside the image. This parameter is tunable.

Interpolation method

Specify which interpolation method the block uses to translate the image. If you select **Nearest neighbor**, the block uses the value of one nearby pixel for the new pixel value. If you select **Bilinear**, the new pixel value is the weighted average of the four nearest pixel values. If you select **Bicubic**, the new pixel value is the weighted average of the sixteen nearest pixel values.

The number of pixels the block considers affects the complexity of the computation. Therefore, the **Nearest-neighbor** interpolation is the most computationally efficient. However, because the accuracy of the method is proportional to the number of pixels considered, the **Bicubic** method is the most accurate.

Rounding mode

Select the rounding mode for fixed-point operations.

Overflow mode

Select the overflow mode for fixed-point operations.

Shear values

Choose how to specify the word length and the fraction length of the shear values.

- When you select **Same word length as input**, the word length of the shear values match that of the input to the block. In this mode, the fraction length of the shear values is automatically set to the binary-point only scaling that provides you with the best precision possible given the value and word length of the shear values.
- When you select **Specify word length**, you can enter the word length of the shear values, in bits. The block automatically sets the fraction length to give you the best precision.
- When you select **Binary point scaling**, you can enter the word length and the fraction length of the shear values, in bits.
- When you select **Slope and bias scaling**, you can enter the word length, in bits, and the slope of the shear values. The bias of all signals in the Computer Vision Toolbox blocks is 0.

This parameter is visible if, for the **Shear values source** parameter, you select **Specify via dialog**.

Product output



As depicted in the previous figure, the output of the multiplier is placed into the product output data type and scaling. Use this parameter to specify how to designate this product output word and fraction lengths.

- When you select **Same as first input**, these characteristics match those of the first input to the block at the I port.
- When you select **Binary point scaling**, you can enter the word length and the fraction length of the product output, in bits.

- When you select **Slope and bias scaling**, you can enter the word length, in bits, and the slope of the product output. The bias of all signals in the Computer Vision Toolbox blocks is 0.

Accumulator

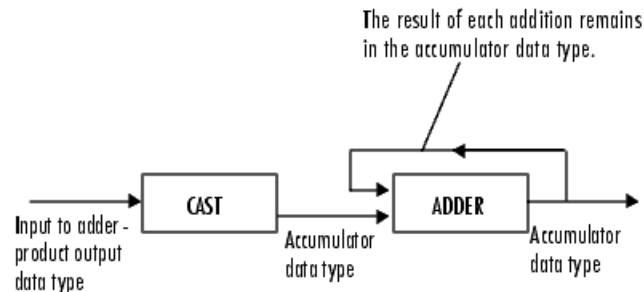

As depicted in the previous figure, inputs to the accumulator are cast to the accumulator data type. The output of the adder remains in the accumulator data type as each element of the input is added to it. Use this parameter to specify how to designate this accumulator word and fraction lengths.

- When you select **Same as product output**, these characteristics match those of the product output.
- When you select **Same as first input**, these characteristics match those of the first input to the block at the I port.
- When you select **Binary point scaling**, you can enter the word length and the fraction length of the accumulator, in bits.
- When you select **Slope and bias scaling**, you can enter the word length, in bits, and the slope of the accumulator. The bias of all signals in the Computer Vision Toolbox blocks is 0.

Output

Choose how to specify the word length and fraction length of the output of the block:

- When you select **Same as first input**, these characteristics match those of the first input to the block at the I port.
- When you select **Binary point scaling**, you can enter the word length and the fraction length of the output, in bits.
- When you select **Slope and bias scaling**, you can enter the word length, in bits, and the slope of the output. The bias of all signals in the Computer Vision Toolbox blocks is 0.

Lock data type settings against change by the fixed-point tools

Select this parameter to prevent the fixed-point tools from overriding the data types you specify on the block mask. For more information, see `fxptdlg`, a reference page on the Fixed-Point Tool in the Simulink documentation.

References

- [1] Wolberg, George. *Digital Image Warping*. Washington: IEEE Computer Society Press, 1990.

See Also

Resize	Computer Vision Toolbox software
Rotate	Computer Vision Toolbox software
Translate	Computer Vision Toolbox software

More About

Nearest Neighbor Interpolation Method

For nearest neighbor interpolation, the block uses the value of nearby translated pixel values for the output pixel values.

For example, suppose this matrix,

```
1 2 3
4 5 6
7 8 9
```

represents your input image. You want to translate this image 1.7 pixels in the positive horizontal direction using nearest neighbor interpolation. The block's nearest neighbor interpolation algorithm is illustrated by the following steps:

- 1 Zero pad the input matrix and translate it by 1.7 pixels to the right.

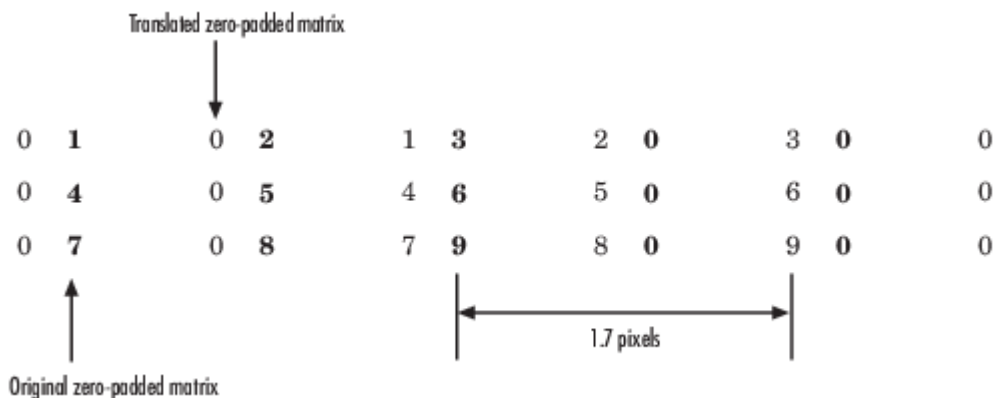

- 2 Create the output matrix by replacing each input pixel value with the translated value nearest to it. The result is the following matrix:

```
0 0 1 2 3
0 0 4 5 6
0 0 7 8 9
```

Note You wanted to translate the image by 1.7 pixels, but this method translated the image by 2 pixels. Nearest neighbor interpolation is computationally efficient but not as accurate as bilinear or bicubic interpolation methods.

Bilinear Interpolation

For bilinear interpolation, the block uses the weighted average of two translated pixel values for each output pixel value.

For example, suppose this matrix,

```
1 2 3
4 5 6
7 8 9
```

represents your input image. You want to translate this image 0.5 pixel in the positive horizontal direction using bilinear interpolation. The block's bilinear interpolation algorithm is illustrated by the following steps:

- 1 Zero pad the input matrix and translate it by 0.5 pixel to the right.

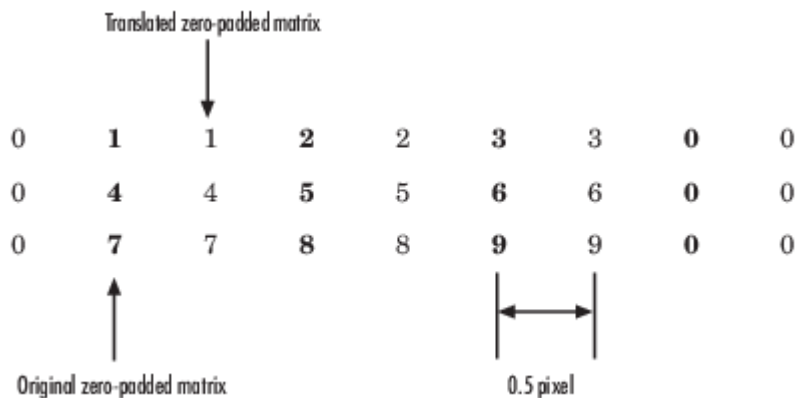

- 2 Create the output matrix by replacing each input pixel value with the weighted average of the translated values on either side. The result is the following matrix where the output matrix has one more column than the input matrix:

```
0.5 1.5 2.5 1.5
  2  4.5 5.5  3
 3.5 7.5 8.5 4.5
```

Bicubic Interpolation

For bicubic interpolation, the block uses the weighted average of four translated pixel values for each output pixel value.

For example, suppose this matrix,

```
1 2 3
4 5 6
7 8 9
```

represents your input image. You want to translate this image 0.5 pixel in the positive horizontal direction using bicubic interpolation. The block's bicubic interpolation algorithm is illustrated by the following steps:

- 1 Zero pad the input matrix and translate it by 0.5 pixel to the right.

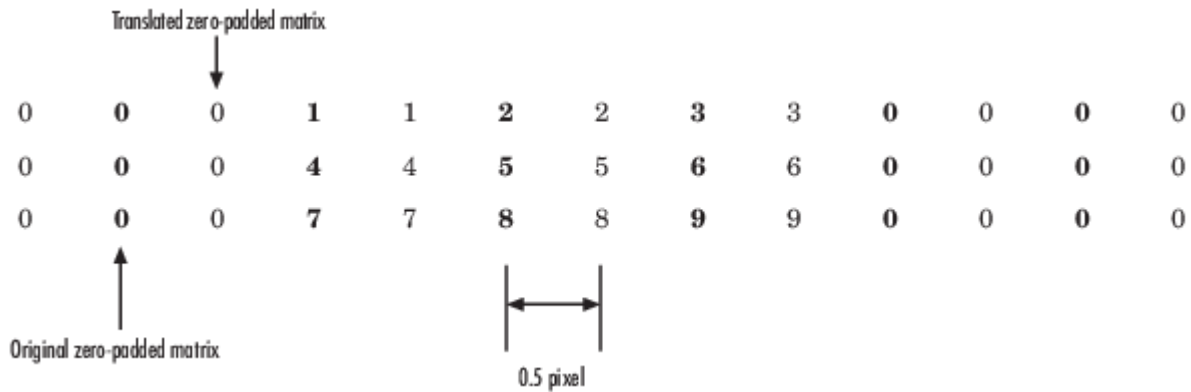

- 2 Create the output matrix by replacing each input pixel value with the weighted average of the two translated values on either side. The result is the following matrix where the output matrix has one more column than the input matrix:

```
0.375  1.5   3   1.625
1.875  4.875 6.375 3.125
3.375  8.25  9.75 4.625
```

Extended Capabilities

C/C++ Code Generation

Generate C and C++ code using Simulink® Coder™.

Introduced before R2006a

Read Binary File

Read video data from binary file

Library: Computer Vision Toolbox / Sinks



Description

The Read Binary File block reads the video data from a binary file and imports it into a Simulink model.

The user-specified block parameters describe the format of the video data. These parameters, along with the raw binary file, create the video data for the Simulink model.

Note This block supports code generation for only those platforms that have file I/O. The block does not support code generation using Simulink Desktop Real-Time or Simulink Real-Time™.

Ports

Output

Y' — Luminance component

3-D array

Luminance component of the video read from the binary file, specified as a 3-D array. The label of this port can be changed using the **Component1** parameter when the **Video format** parameter is set to Custom.

Data Types: int8 | int16 | int32 | uint8 | uint16 | uint32

Cb — Blue difference component

3-D array

Blue difference component of the video read from the binary file, specified as a 3-D array. The label of this port can be changed using the **Component2** parameter when the **Video format** parameter is set to Custom.

Data Types: int8 | int16 | int32 | uint8 | uint16 | uint32

Cr — Red difference component

3-D array

Red difference component of the video read from the binary file, specified as a 3-D array. The label of this port can be changed using the **Component3** parameter when the **Video format** parameter is set to Custom.

Data Types: int8 | int16 | int32 | uint8 | uint16 | uint32

A — Alpha component

3-D array

Alpha component of the video read from the binary file, specified as a 3-D array. The label of this port can be changed using the **Component4** parameter when the **Video format** parameter is set to Custom.

Dependencies

To enable this port, use one of these options.

- Set the **Video format** parameter to Four character codes and set the **Four character code** parameter to AYUV or IF09.
- Set the **Video format** parameter to Custom and the **Number of output components** parameter to 4.

Data Types: int8 | int16 | int32 | uint8 | uint16 | uint32

T — Transparency component

3-D array

Transparency component of the video read from the binary file, specified as a 3-D array.

Dependencies

To enable this port, set the **Video format** parameter to Four character codes and set the **Four character code** parameter to Y41T or Y42T.

Data Types: int8 | int16 | int32 | uint8 | uint16 | uint32

EOF — Last video frame indicator

scalar

The port outputs a 1 when the component ports output the last video frame. For every frame before that, it outputs a 0.

Dependencies

To enable this port, select the **Output end-of-file indicator** parameter.

Data Types: Boolean

Parameters**File name — Name of binary file**

vipmen.bin (default) | file name

Specify the name of the binary source file to read video data from.

Video format — Format of video data

Four character codes (default) | Custom

Specify the format of the video data as one of these options.

- Four character codes (FOURCC) — For more information about these codes, see <https://www.fourcc.org>.

- Custom — Read the video data from a binary file of a custom format.

Four character code — Format of binary file

I420 (default) | AYUV | CLJR | cyuv | GREY | IF09 | IMC1 | IMC2 | IMC3 | IMC4 | IUYV | IY41 | IYU1 | IYU2 | IYUV | NV12 | NV21 | UYNV | UYNY | V210 | Y411 | Y41P | Y41T | Y422 | Y42T | Y8 | Y800 | YUNV | YUY2 | YUYV | YV12 | YV16 | YVU9 | YVYU | ...

Specify the four character code of the binary file codec. The value of this parameter also sets the number of output ports. For information on which four character codes enable which output ports, see [Output Ports for Four Character Codes](#) on page 1-328.

Dependencies

To enable this parameter, set the **Video format** parameter to `Four character codes`.

FrameSize Rows — Number of rows in output array

120 (default) | positive integer

Specify the number of rows in the output array as a positive integer. The value of this parameter must match the dimensions of the data inside the file.

Dependencies

To enable this parameter, set the **Video format** parameter to `Four character codes`.

FrameSize Cols — Number of columns in output array

160 (default) | positive integer

Specify the number of columns in the output array as a positive integer. The value of this parameter must match the dimensions of the data inside the file.

Dependencies

To enable this parameter, set the **Video format** parameter to `Four character codes`.

Line ordering — Output array fill direction

Top line first (default) | Bottom line first

If you select `Top line first`, the block first fills the first row of the output array with the corresponding contents of the binary file. It then fills the other rows in increasing order. When you select `Bottom line first`, the block first fills the last row of the output array with the corresponding contents of the binary file. It then fills the other rows in decreasing order.

Number of times to play file — Number of times to play the file

1 (default) | positive integer | inf

Specify the number of times to repeat the binary file as a positive integer or `inf`. For any positive integer value `n` of this parameter, the block plays the binary file `n` times. For a value of `inf`, the block plays the file indefinitely until the end of simulation.

Output end-of-file indicator — Indicate when block output reaches last frame

off (default) | on

This parameter indicates when the block output reaches the last video frame in the binary file. Selecting this parameter enables the **EOF** port. The output from the **EOF** port is 1 when the block output reaches the last video frame. For all other frames, it is 0.

Sample time — Sample period of output

1/30 (default) | positive scalar | -1

Specify the sample period of the output. Sample time indicates when, during simulation the block produces output. The value of this parameter must be a positive scalar less than the simulation time or -1. It cannot be 0. When set to -1, the block inherits the sample time from the simulink model.

Bit stream format — Specifies if data is planar or packed

Planar (default) | Packed

Specify the data format of the binary file as planar or packed. If the data is packed, use the **FrameSize Rows** and **FrameSize Cols** parameters to define the size of the output array.

Dependencies

To enable this parameter, set the **Video format** parameter to Custom.

Number of output components — Number of components in binary file

3 (default) | 1 | 2 | 4

Specify the number of output components from the binary file. This parameter sets the number of output ports.

Dependencies

To enable this parameter, set the **Video format** parameter to Custom.

Component1 — Name for luminance component

Y' (default) | component name

Specify the name for the luminance component of the output array. The luminance component is the first component from the input binary file.

Dependencies

To enable this parameter, set the **Video format** parameter to Custom, set the **Number of output components** parameter to 1 or greater .

Component2 — Name for blue difference component

Cb (default) | component name

Specify the name for the blue difference component of the output array. The blue difference component is the second component from the input binary file.

Dependencies

To enable this parameter, set the **Video format** parameter to Custom, set the **Number of output components** parameter to 2 or greater .

Component3 — Name for red difference component

Cr (default) | component name

Specify the name for the red difference component of the output array using this parameter. The red difference component is the third component from the input binary file.

Dependencies

To enable this parameter, set the **Video format** parameter to Custom, set the **Number of output components** parameter to 3 or greater .

Component4 — Name for alpha component

Alpha (default) | component name

Specify the name for the alpha component of the output array. The alpha component is the fourth component from the input binary file.

Dependencies

To enable this parameter, set the **Video format** parameter to Custom, set the **Number of output components** parameter to 4.

Bits1 — Size of luminance component

8 (default) | 16 | 24 | 32

Specify the size of the luminance component in the output array. The value of this parameter determines the interpretation of the video stream data as 8-bit, 16-bit, 24-bit, or 32-bit.

Dependencies

To enable this parameter, set the **Video format** parameter to Custom, and set the **Number of output components** parameter to 1 or greater.

Bits2 — Size of blue difference component

8 (default) | 16 | 24 | 32

Specify the size of the blue difference component in the output array. The value of this parameter determines the interpretation of the video stream data as 8-bit, 16-bit, 24-bit, or 32-bit.

Dependencies

To enable this parameter, set the **Video format** parameter to Custom, and set the **Number of output components** parameter to 2 or greater.

Bits3 — Size of red difference component

8 (default) | 16 | 24 | 32

Specify the size of the red difference component in the output array. The value of this parameter determines the interpretation of the video stream data as 8-bit, 16-bit, 24-bit, or 32-bit.

Dependencies

To enable this parameter, set the **Video format** parameter to Custom, and set the **Number of output components** parameter to 3 or greater.

Bits4 — Size of alpha component

8 (default) | 16 | 24 | 32

Specify the size of the alpha component in the output array. The value of this parameter determines the interpretation of the video stream data as 8-bit, 16-bit, 24-bit, or 32-bit.

Dependencies

To enable this parameter, set the **Video format** parameter to Custom, and set the **Number of output components** parameter to 4 .

Rows1 — Number of rows for luminance component

120 (default) | positive integer

Specify the number of rows for the luminance component in the output array. The value of this parameter must be a positive integer.

Dependencies

To enable this parameter, set the **Video format** parameter to Custom, and set the **Number of output components** parameter to 1 or greater.

Rows2 — Number of rows for blue difference component

60 (default) | positive integer

Specify the number of rows for the blue difference component in the output array. The value of this parameter must be a positive integer.

Dependencies

To enable this parameter, set the **Video format** parameter to Custom, and set the **Number of output components** parameter to 2 or greater.

Rows3 — Number of rows for red difference component

60 (default) | positive integer

Specify the number of rows for the red difference component in the output array. The value of this parameter must be a positive integer.

Dependencies

To enable this parameter, set the **Video format** parameter to Custom, and set the **Number of output components** parameter to 3 or greater.

Rows4 — Number of rows for alpha component

288 (default) | positive integer

Specify the number of rows for the alpha component in the output array. The value of this parameter must be a positive integer.

Dependencies

To enable this parameter, set the **Video format** parameter to Custom, and set the **Number of output ports** parameter to 4.

Cols1 — Number of columns for luminance component

160 (default) | positive integer

Specify the number of columns for the luminance component in the output array. The value of this parameter must be a positive integer.

Dependencies

To enable this parameter, set the **Video format** parameter to Custom, and set the **Number of output components** parameter to 1 or greater.

Cols2 — Number of columns for blue difference component

80 (default) | positive integer

Specify the number of columns for the blue difference component in the output array. The value of this parameter must be a positive integer.

Dependencies

To enable this parameter, set the **Video format** parameter to Custom, and set the **Number of output components** parameter to 2 or greater.

Cols3 — Number of columns for red difference component

80 (default) | positive integer

Specify the number of columns for the luminance component in the output array. The value of this parameter must be a positive integer.

Dependencies

To enable this parameter, set the **Video format** parameter to Custom, and set the **Number of output components** parameter to 3 or greater.

Cols4 — Number of columns for the alpha component

352 (default) | positive integer

Specify the number of columns for the alpha component in the output array. The value of this parameter must be a positive integer.

Dependencies

To enable this parameter, set the **Video format** parameter to Custom, and set the **Number of output components** parameter to 4.

Component order in binary file — Arrangement of components in binary file

[1 2 3] (default) | vector of valid component identifiers

Specify the arrangement of components in the binary file. Identify the components by the assigned numerals, from 1 to 4, in desired order. You must include all the enabled components when setting this parameter.

Dependencies

To enable this parameter, set the **Video format** parameter to Custom.

Interlaced video — Read video data from file as interlaced

off (default) | on

Select this parameter when the binary file contains interlaced video data.

Dependencies

To enable this parameter, set the **Video format** parameter to Custom.

Input file has signed data – File has signed integers

off (default) | on

Select this parameter when the binary file contains signed integers.

Dependencies

To enable this parameter, set the **Video format** parameter to Custom.

Byte order in binary file – Byte order of binary file

Little endian (default) | Big endian

Specify the byte order of the binary file as either little endian or big endian.

Dependencies

To enable this parameter, set the **Video format** parameter to Custom.

Block Characteristics

Data Types	integer
Multidimensional Signals	no
Variable-Size Signals	no

Output Ports for Four Character Codes

Four Character Code	Output ports
I420	Y' Cb Cr
AYUV	Y' Cb Cr A
CLJR	Y' Cb Cr
cyuv	Y' Cb Cr
GREY	Y'
IF09	Y' Cb Cr A
IMC1	Y' Cb Cr
IMC2	Y' Cb Cr
IMC3	Y' Cb Cr
IMC4	Y' Cb Cr
IUYV	Y' Cb Cr
IY41	Y' Cb Cr
IYU1	Y' Cb Cr
IYU2	Y' Cb Cr
IYUV	Y' Cb Cr
NV12	Y' Cb Cr
NV21	Y' Cb Cr

Four Character Code	Output ports
UYNV	Y' Cb Cr
UYNY	Y' Cb Cr
V210	Y' Cb Cr
Y411	Y' Cb Cr
Y41P	Y' Cb Cr
Y41T	Y' Cb Cr T
Y422	Y' Cb Cr
Y42T	Y' Cb Cr T
Y8	Y'
Y800	Y'
YUNV	Y' Cb Cr
YUY2	Y' Cb Cr
YUYV	Y' Cb Cr
YV12	Y' Cb Cr
YV16	Y' Cb Cr
YVU9	Y' Cb Cr
YVYU	Y' Cb Cr

Extended Capabilities

C/C++ Code Generation

Generate C and C++ code using Simulink® Coder™.

See Also

Blocks

From Multimedia File | Write Binary File

Introduced before R2006a

Write Binary File

Write binary video data to file

Library: Computer Vision Toolbox / Sinks



Description

The Write Binary File block takes the video data from a Simulink model and exports it to a binary file.

This block produces a raw binary file with no header information. It has no encoded information providing the data type, frame rate, or dimensionality. The video data for this block appears in row-major format.

Note This block supports code generation only for platforms that have file I/O available. The block does not support code generation using Simulink Desktop Real-Time or Simulink Real-Time.

Ports

Input

Y' — Luminance component of input video stream

scalar | vector | matrix

Luminance component of the input video stream, specified as a scalar, vector, or matrix. The label of this port can be changed using the **Component1** parameter when the **Video format** parameter is set to Custom.

Data Types: int8 | int16 | int32 | uint8 | uint16 | uint32

Cb — Blue difference component of the input video stream

scalar | vector | matrix

Blue difference component of the input video stream, specified as a scalar, vector, or matrix. The label of this port can be changed using the **Component2** parameter when the **Video format** parameter is set to Custom.

Data Types: int8 | int16 | int32 | uint8 | uint16 | uint32

Cr — Red difference component of input video stream

scalar | vector | matrix

Red difference component of the input video stream, specified as a scalar, vector, or matrix. The label of this port can be changed using the **Component3** parameter when the **Video format** parameter is set to Custom.

Data Types: int8 | int16 | int32 | uint8 | uint16 | uint32

A — Alpha component of input video stream

scalar | vector | matrix

Alpha component of the input video stream, specified as a scalar, vector, or matrix. The label of this port can be changed using the **Component4** parameter when the **Video format** parameter is set to Custom.

Dependencies

To enable this port, use one of these options.

- Set the **Video format** parameter to Four character codes, and set the **Four character code** parameter to AYUV or IF09.
- Set the **Video format** parameter to Custom, and the **Number of inputs** parameter to 4. In this case, the name of this port is **Alpha**.

Data Types: int8 | int16 | int32 | uint8 | uint16 | uint32

T — Transparency component of input video stream

scalar | vector | matrix

Transparency component of the input video stream, specified as a scalar, vector, or matrix.

Dependencies

To enable this port, set the **Video format** parameter to Four character codes, and set the **Four character code** parameter to Y41T or Y42T.

Data Types: int8 | int16 | int32 | uint8 | uint16 | uint32

Parameters**File name — Name of the binary file**

output.bin (default) | file name

Specify the name of the output binary file, with a .bin extension, for the video data. Click **Save As** to specify the location for the file.

Video format — Format of the video data

Four character codes (default) | Custom

Specify the format of the video data as one of these options.

- Four character codes (FOURCC) — For more information about these codes, see <https://www.fourcc.org>.
- Custom — Read the video data from a binary file of a custom format.

Four character code — Format of binary file

I420 (default) | AYUV | CLJR | cyuv | GREY | IF09 | IMC1 | IMC2 | IMC3 | IMC4 | IUUV | IY41 | IYU1 | IYU2 | IYUV | NV12 | NV21 | UYNV | UYNY | V210 | Y411 | Y41P | Y41T | Y422 | Y42T | Y8 | Y800 | YUNV | YUY2 | YUYV | YV12 | YV16 | YVU9 | YVYU | ...

Select the four character code of the desired codec for the binary file. The value of this parameter also determines the number of input ports on the block. For information on which four character codes enable which input ports, see “Input Ports for Four Character Codes” on page 1-335.

Dependencies

To enable this parameter, set the **Video Format** parameter to `Four character codes`.

Line ordering – Binary file fill direction

`Top line first (default) | Bottom line first`

If you select `Top line first`, the block begins filling the binary file with the first row of the video frame. It then fills the file with the other rows in increasing order. If you select `Bottom line first`, the block begins filling the binary file with the last row of the video frame. It then fills the file with the other rows in decreasing order.

Bit stream format – Data format of binary file

`Planar (default) | Packed`

Specify the data format of the binary file as `Planar` or `Packed`.

Dependencies

To enable this parameter, set the **Video Format** parameter to **Custom**.

Number of inputs – Number of components in input video stream

`3 (default) | 1 | 2 | 4`

Specify the number of components in the input video stream. This parameter sets the number of input ports.

Dependencies

To enable this parameter, set the **Video Format** parameter to `Custom`.

Inherit size of components from input data type – All components have same number of bits

`on (default) | off`

Select the **Inherit size of components from input data type** parameter to indicate that all of the components have the same number of bits as the input data type. If you clear this parameter, you can specify the number of bits for each enabled component using the associated **Bits** parameter.

Dependencies

To enable this parameter, set the **Video Format** parameter to `Custom`.

Component1 – Name of luminance component input port

`Y' (default) | component name`

Specify the name of the input port for the luminance component of the input video stream.

Dependencies

To enable this parameter, set the **Video format** parameter to `Custom`, set the **Number of inputs** parameter to `1` or greater .

Component2 – Name of blue difference component

`Cb (default) | component name`

Specify the name of the input port for the blue difference component of the input video stream.

Dependencies

To enable this parameter, set the **Video format** parameter to Custom, set the **Number of inputs** parameter to 2 or greater .

Component3 — Name of red difference component

Cr (default) | component name

Specify the name of the input port for the red difference component of the input video stream.

Dependencies

To enable this parameter, set the **Video format** parameter to Custom, set the **Number of inputs** parameter to 3 or greater .

Component4 — Name of alpha component

Alpha (default) | component name

Specify the name of the input port for the alpha component of the input video stream.

Dependencies

To enable this parameter, set the **Video format** parameter to Custom, set the **Number of inputs** parameter to 4.

Bits1 — Size of luminance component

8 (default) | 0 | 16 | 24 | 32

Specify the size of the luminance component in the input video stream. The value of this parameter determines the interpretation of the video stream data as 8-bit, 16-bit, 24-bit, or 32-bit.

Dependencies

To enable this parameter, set the **Video format** parameter to Custom, and set the **Number of inputs** parameter to 1 or greater, and select the **Inherit size of components from input data type** parameter.

Bits2 — Size of blue difference component

8 (default) | 0 | 16 | 24 | 32

Specify the size of the blue difference component in the input video stream. The value of this parameter determines the interpretation of the video stream data as 8-bit, 16-bit, 24-bit, or 32-bit.

Dependencies

To enable this parameter, set the **Video format** parameter to Custom, and set the **Number of inputs** parameter to 2 or greater, and select the **Inherit size of components from input data type** parameter.

Bits3 — Size of red difference component

8 (default) | 0 | 16 | 24 | 32

Specify the size of the red difference component in the input video stream. The value of this parameter determines the interpretation of the video stream data as 8-bit, 16-bit, 24-bit, or 32-bit.

Dependencies

To enable this parameter, set the **Video format** parameter to Custom, and set the **Number of inputs** parameter to 3 or greater, and select the **Inherit size of components from input data type** parameter.

Bits4 – Size of alpha component

8 (default) | 0 | 16 | 24 | 32

Specify the size of the alpha component in the input video stream. The value of this parameter determines the interpretation of the video stream data as 8-bit, 16-bit, 24-bit, or 32-bit.

Dependencies

To enable this parameter, set the **Video format** parameter to Custom, and set the **Number of inputs** parameter to 4, and select the **Inherit size of components from input data type** parameter.

Component order in binary file – Arrangement of components in binary file

[1 2 3] (default) | vector of valid component identifiers

Specify the arrangement of the components in the binary file. Identify the components by the assigned numerals, from 1 to 4, in the desired order. You must include all enabled components when setting this parameter.

Dependencies

To enable this parameter, set the **Video format** parameter to Custom.

Interlaced video – Read video data as interlaced

off (default) | on

Select this parameter when the video stream contains interlaced video data.

Dependencies

To enable this parameter, set the **Video format** parameter to Custom.

Write signed data to output file – Write signed data to output binary file

off (default) | on

Select this parameter when the input data is signed.

Dependencies

To enable this parameter, set the **Video format** parameter to Custom.

Byte order in binary file – Byte order in output binary file

Little endian (default) | Big endian

Specify the byte order in the output binary file as either little endian or big endian.

Dependencies

To enable this parameter, set the **Video format** parameter to Custom.

Block Characteristics

Data Types	integer
Multidimensional Signals	no
Variable-Size Signals	no

Input Ports for Four Character Codes

Four Character Code	Input ports
I420	Y' Cb Cr
AYUV	Y' Cb Cr A
CLJR	Y' Cb Cr
cyuv	Y' Cb Cr
GREY	Y'
IF09	Y' Cb Cr A
IMC1	Y' Cb Cr
IMC2	Y' Cb Cr
IMC3	Y' Cb Cr
IMC4	Y' Cb Cr
IUYV	Y' Cb Cr
IY41	Y' Cb Cr
IYU1	Y' Cb Cr
IYU2	Y' Cb Cr
IYUV	Y' Cb Cr
NV12	Y' Cb Cr
NV21	Y' Cb Cr
UYNV	Y' Cb Cr
UYNV	Y' Cb Cr
V210	Y' Cb Cr
Y411	Y' Cb Cr
Y41P	Y' Cb Cr
Y41T	Y' Cb Cr T
Y422	Y' Cb Cr
Y42T	Y' Cb Cr T
Y8	Y'
Y800	Y'
YUNV	Y' Cb Cr
YUY2	Y' Cb Cr

Four Character Code	Input ports
YUYV	Y' Cb Cr
YV12	Y' Cb Cr
YV16	Y' Cb Cr
YVU9	Y' Cb Cr
YVYU	Y' Cb Cr

Extended Capabilities

C/C++ Code Generation

Generate C and C++ code using Simulink® Coder™.

See Also

Blocks

[Read Binary File](#) | [To Multimedia File](#)

Introduced before R2006a

Template Matching

Locate a template in an image

Library: Computer Vision Toolbox / Analysis & Enhancement

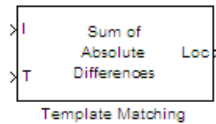

Description

The Template Matching block finds the best match of a template within an input image. The block computes match metric values by shifting a template over a region of interest or the entire image, and then finds the best match location.

The block outputs either the match metric values or the one-based (x,y) coordinates of the best template match. Optionally the block can output an N -by- N matrix of the match metric values centered around the best match location.

Ports

Input

I — Image

image

Input image to use with the template. The block does not pad the input data. Therefore, it can only compute values for the match metrics between the input image and the template, where the template is positioned such that it falls entirely on the input image. A set of all such positions of the template is termed as the *valid* region of the input image. The size of the valid region is the difference between the sizes of the input and template images plus one.

$$\text{size}_{\text{valid}} = \text{size}_{\text{input}} - \text{size}_{\text{template}} + 1 \quad (1-3)$$

Data Types: single | double | int8 | int16 | int32 | int64 | uint8 | uint16 | uint32 | uint64 | Boolean | fixed point

T — Template

M -by- N matrix

Template, specified as an M -by- N matrix

The Template Matching block does not pad the input data. Therefore, it can only compute values for the match metrics between the input image and the template, where the template is positioned such that it falls entirely on the input image. A set of all such positions of the template is termed as the *valid* region of the input image. The size of the valid region is the difference between the sizes of the input and template images plus one.

$$\text{size}_{\text{valid}} = \text{size}_{\text{input}} - \text{size}_{\text{template}} + 1 \quad (1-4)$$

Data Types: single | double | uint8 | Boolean | fixed point

ROI – Region of interest

four-element vector

Region of interest vector in the format $(x,y,width,height)$, where (x,y) are one-based coordinates for the upper-left corner of the region. The block outputs the best match location index relative to the top left corner of the input image.

Data Types: `single` | `double` | `uint8` | `Boolean` | `fixed point`**Output****Metric – Match metric values**

matrix

Matrix of match metric values. The matrix of the match metrics always implements single-step exhaustive window iteration. Therefore, the block computes the metric values at every pixel.

Dependencies

When you set the **Output** parameter to `Metric matrix`, the block outputs the valid image size.

Data Types: `single` | `double` | `uint8` | `Boolean` | `fixed point`**Loc – Best match locations**

two-element vector

Best template match located at the one-based (x,y) coordinates. When in the ROI processing mode, the block treats the image around the ROI as an extension of the ROI subregion. Therefore, it computes the best match locations true to the actual boundaries of the ROI. The block outputs the best match coordinates, relative to the top-left corner of the image. The one-based $[x y]$ coordinates of the location correspond to the center of the template. The following table shows how the block outputs the center coordinates for odd and even templates:

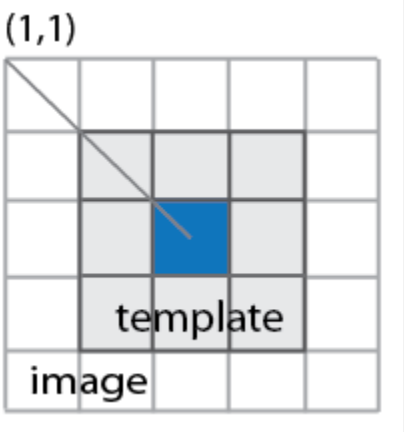
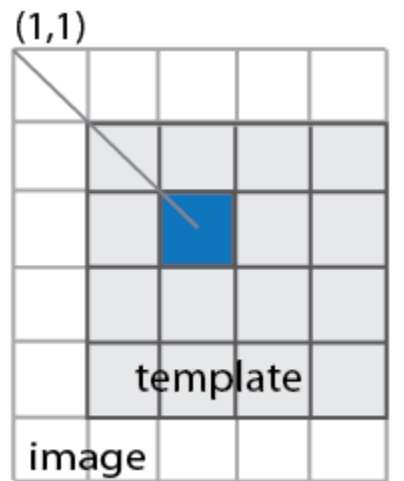
Odd number of pixels in template	Even number of pixels in template
	

Data Types: `uint32`**NMetric – Metric values in neighborhood of best match** N -by- N matrix

Metric values in the neighborhood of the best match, returned as an N -by- N matrix. N , specified in the mask, must be an odd number. When you select **Best match location** to return the matrix of metrics in a neighborhood around the best match, an exhaustive loop computes all the metric values for the N -by- N neighborhood. This output is particularly useful for performing template matching with subpixel accuracy.

Data Types: `single` | `double` | `uint8` | `Boolean` | `fixed point`

NValid — Valid neighborhood

`off` | `on`

Enable to track the valid neighborhood region. The neighborhood matrix of metric values is valid inside of the ROI. The block sets the **NValid** output as follows:

- 1 — The neighborhood containing the best match is completely inside the region of interest.
- 0 — The neighborhood containing the best match is completely or partially outside of the region of interest.

Dependencies

This port appears when you enable the **Output NxN matrix of metric values around best match** parameter.

Data Types: `Boolean`

ROIValid — Valid region of interest

`off` | `on`

Enable to track the valid region of interest. If the ROI lies partially outside the valid image, the block only processes the intersection of the ROI and the valid image. The block sets the **ROIValid** output as follows:

- 1 — The ROI lies completely inside the valid part of the input image.
- 0 — The ROI lies completely or partially outside of the valid part of the input image.

Dependencies

This port appears when you enable the **Output flag indicating if ROI is valid** parameter.

Data Types: `Boolean`

Parameters

Main Tab

Match metric — Match metric

`Sum of absolute differences (default)` | `Sum of squared differences` | `Maximum absolute difference`

Select match metric as one of:

- `Sum of absolute differences (SAD)`
- `Sum of squared differences (SSD)`
- `Maximum absolute difference (MaxAD)`

The block computes the match metric at each step of the iteration. Choose the match metric that best suits your application. The block calculates the global optimum for the best metric value. It uses the valid subregion of the input image intersected by the ROI, if provided.

Output — Match metric

Match metric (default) | Best match location

Select the type of output as one of:

- **Match metric** — Output the match metric matrix. This option adds the **Metric** output port to the block.
- **Best match location** — Output the [x,y] coordinates for the location of the best match. This option adds the **Loc** output port to the block. It also makes the **Search method**, **Output NxN matrix of metric values around best match**, and **Enable ROI processing** parameters available.

The **Output** parameter on the Data Types pane appears when you set the **Output** parameter on the **Main tab** to **Metric matrix** or if you set it to **Best match location** and you enable the **Output NxN matrix of metric values around best match** parameter.

Search method — Search method

Exhaustive (default) | Three-step

Specify the search method as either **Exhaustive** or **Three-step**. The **Exhaustive** search method is computationally intensive because it searches at every pixel location of the image. However, this method provides a more precise result.

The **Three-step** search method is a fast search that uses a neighborhood approach versus a search at every pixel. The search starts with a step size equal to or slightly greater than half of the maximum search range and then employs the following steps:

- 1** The block compares nine search points in each step. There is a central point and eight search points located on the search area boundary.
- 2** The block decrements the step size by one, after each step, ending the search with a step size of one pixel.
- 3** At each new step, the block moves the search center to the best matching point resulting from the previous step. The number one blue circles in the figure below represent a search with a starting step size of three. The number two green circles represent the next search, with step size of two, centered around the best match found from the previous search. Finally, the number three orange circles represent the final search, with step size of one, centered around the previous best match.

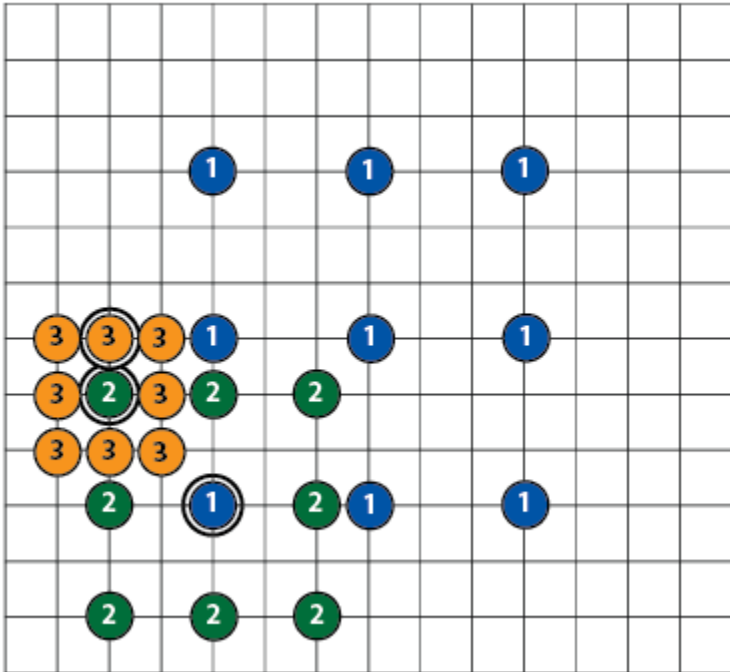

Dependencies

This parameter appears when you set the **Output** parameter to Best match location.

Output NxN matrix of metric values around best match – Output N-by-N matrix
on (default) | off

Enable to add the **NMetric** and **NValid** ports.

Dependencies

This parameter appears when you set the **Output** parameter to Best match location.

N – Size of output matrix
3 (default) | integer

Size of output matrix. This value determines the size of the N-by-N output matrix centered around the best match location index. N must be an odd number.

Dependencies

This parameter appears when you enable the **Output NxN matrix of metric values around best match** parameter.

Enable ROI processing – Enable ROI processing
on (default) | off

Enable ROI processing.

Dependencies

- This parameter appears when you set the **Output** parameter to Best match location.

- When you enable this parameter, the block adds the **ROI** input port, and the **Output flag indicating if ROI is valid** parameter appears.

Output flag indicating if ROI is valid — Valid ROI

off (default) | on

Enable to add the **ROIValid** port.

Dependencies

This parameter appears when you enable the **Enable ROI processing** parameter.

Data Types Tab

For details on the fixed-point block parameters, see “Specify Fixed-Point Attributes for Blocks” .

Block Characteristics

Data Types	Boolean double fixed point integer single
Multidimensional Signals	no
Variable-Size Signals	yes

Algorithms

Match Metrics

The match metrics use a difference equation with general form:

$$d_p(x, y) = \left(\sum_{i=1}^n |x_i - y_i|^p \right)^{1/p}$$

l_n^p denotes the metric space (R^n, d_p) for R^n $n > 1$.

Sum of Absolute Differences (SAD)

The SAD metric is also known as the *Taxicab* or *Manhattan Distance* metric. It sums the absolute values of the differences between pixels in the original image and the corresponding pixels in the template image. This metric is the l^1 norm of the difference image. The lowest SAD score estimates the best position of template within the search image. The general SAD distance metric becomes:

$$d_1(I_j, T) = \sum_{i=1}^n |I_{i,j} - T_i|$$

Sum of Squared Differences (SSD)

The SSD metric is also known as the Euclidean Distance metric. It sums the square of the absolute differences between pixels in the original image and the corresponding pixels in the template image. This metric is the square of the l^2 norm of the difference image. The general SSD distance metric becomes:

$$d_2(I_j, T) = \sum_{i=1}^n |I_{i,j} - T_i|^2$$

Maximum Absolute Difference (MaxAD)

The MaxAD metric is also known as the Uniform Distance metric. It sums the maximum of absolute values of the differences between pixels in the original image and the corresponding pixels in the template image. This distance metric provides the l^∞ norm of the difference image. The general MaxAD distance metric becomes:

$$d_\infty(I_j, T) = \lim_{x \rightarrow \infty} \sum_{i=1}^n |I_{i,j} - T_i|^x$$

which simplifies to:

$$d_\infty(I_j, T) = \max_i |I_{i,j} - T_i|^p$$

References

- [1] Koga T., et. Al. Motion-compensated interframe coding for video conferencing. In National Telecommunications Conference. Nov. 1981, G5.3.1-5, New Orleans, LA.
- [2] Zakai M., "General distance criteria" *IEEE Transaction on Information Theory*, pp. 94-95, January 1964.
- [3] Yu, J., J. Amores, N. Sebe, Q. Tian, "A New Study on Distance Metrics as Similarity Measurement" IEEE International Conference on Multimedia and Expo, 2006 .

Extended Capabilities

C/C++ Code Generation

Generate C and C++ code using Simulink® Coder™.

Fixed-Point Conversion

Design and simulate fixed-point systems using Fixed-Point Designer™.

See Also

Block Matching

Topics

"Video Stabilization"

Introduced in R2009b

To Multimedia File

Write video frames and audio samples to multimedia file

Library: Computer Vision Toolbox / Sinks

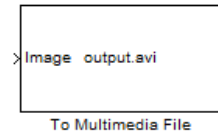

Description

The To Multimedia File block writes video frames, audio samples, or both to a multimedia file (.avi, .wav, .mj2, .mp4, or .m4v format).

You can compress the video frames or audio samples by selecting a compression algorithm. You can also control the type of video or audio in addition to other related properties the multimedia file receives.

If you have a Simulink Coder license, you can generate a code from a model containing this block. To run a generated executable file, you may need to add precompiled shared library files to your system path. See “Simulink Shared Library Dependencies”, and “Accelerating Simulink Models” for details.

Note This block supports code generation for platforms that have file I/O available. You cannot use this block with Simulink Desktop Real-Time software, because that product does not support file I/O.

This block performs best on platforms with Version 11 or later of Windows Media® Player software. This block supports only uncompressed RGB24 AVI files on Linux and Mac platforms.

Ports

Input

Image — Input image frame

matrix | array

Specify the input image frame as a matrix or an array. To write an intensity image frame to a multimedia file, specify it as an M -by- N matrix. For a color image frame, specify it as an M -by- N -by-3 array.

Dependencies

To enable this port:

- Set the **File type** parameter to AVI, MJ-2000, WMV, or MPEG4.
- If the **File type** parameter value is not MJ-2000, set the **Write** parameter to Video and audio or Video only.
- If the **File type** parameter value is AVI or MPEG4, set the **File color format** parameter to RGB.
- Set the **Image signal** parameter to One multidimensional signal.

Data Types: `single` | `double` | `int8` | `int16` | `int32` | `uint8` | `uint16` | `uint32` | `Boolean`

R — Red color component of image

`matrix`

Specify the red color component of the input image frame as an M -by- N matrix.

Dependencies

To enable this port:

- Set the **File type** parameter to `AVI`, `MJ-2000`, `WMV`, or `MPEG4`.
- If the **File type** parameter value is not `MJ-2000`, set the **Write** parameter to `Video and audio` or `Video only`.
- If the **File type** parameter value is `AVI` or `MPEG4`, set the **File color format** parameter to `RGB`.
- Set the **Image signal** parameter to `Separate color signals`.

Data Types: `single` | `double` | `int8` | `int16` | `int32` | `uint8` | `uint16` | `uint32` | `Boolean`

G — Green color component of image

`matrix`

Specify the green color component of the input image frame as an M -by- N matrix.

Dependencies

To enable this port:

- Set the **File type** parameter to `AVI`, `MJ-2000`, `WMV`, or `MPEG4`.
- If the **File type** parameter value is not `MJ-2000`, set the **Write** parameter to `Video and audio` or `Video only`.
- If the **File type** parameter value is `AVI` or `MPEG4`, set the **File color format** parameter to `RGB`.
- Set the **Image signal** parameter to `Separate color signals`.

Data Types: `single` | `double` | `int8` | `int16` | `int32` | `uint8` | `uint16` | `uint32` | `Boolean`

B — Blue color component of image

`matrix`

Specify the blue color component of the input image frame as an M -by- N matrix.

Dependencies

To enable this port:

- Set the **File type** parameter to `AVI`, `MJ-2000`, `WMV`, or `MPEG4`.
- If the **File type** parameter value is not `MJ-2000`, set the **Write** parameter to `Video and audio` or `Video only`.
- If the **File type** parameter value is `AVI` or `MPEG4`, set the **File color format** parameter to `RGB`.
- Set the **Image signal** parameter to `Separate color signals`.

Data Types: `single` | `double` | `int8` | `int16` | `int32` | `uint8` | `uint16` | `uint32` | `Boolean`

Y — Luma component of image

matrix

Specify the luma component of the input image frame as an M -by- N matrix.

Dependencies

To enable this port:

- Set the **File type** parameter to AVI or MPEG4.
- Set the **Write** parameter to Video and audio or Video only.
- Set the **File color format** parameter to YCbCr 4:2:2.

Data Types: single | double | int8 | int16 | int32 | uint8 | uint16 | uint32 | Boolean

Cb — Blue-difference chrominance component of image

matrix

Specify the blue-difference chrominance component of the input image as an M -by- $N/2$ matrix.

Dependencies

To enable this port:

- Set the **File type** parameter to AVI or MPEG4.
- Set the **Write** parameter to Video and audio or Video only.
- Set the **File color format** parameter to YCbCr 4:2:2.

Data Types: single | double | int8 | int16 | int32 | uint8 | uint16 | uint32 | Boolean

Cr — Red-difference chrominance component of image

matrix

Specify the red-difference chrominance component of the input image as an M -by- $N/2$ matrix.

Dependencies

To enable this port:

- Set the **File type** parameter to AVI or MPEG4.
- Set the **Write** parameter to Video and audio or Video only.
- Set the **File color format** parameter to YCbCr 4:2:2.

Data Types: single | double | int8 | int16 | int32 | uint8 | uint16 | uint32 | Boolean

Audio — Input audio signal

vector | matrix

Specify the input audio signal as a vector or a matrix. When specified as a matrix, the block treats each column as an independent channel.

Dependencies

To enable this port:

- Set the **File type** parameter to AVI, WAV, WMA, MPEG4, FLAC, or OGG.
- If the **File type** parameter value is AVI, WMV, or MPEG4 set the **Write** parameter to Video and audio or Audio only.

Data Types: single | double | int16 | int32 | uint8

Parameters

File name — Name of multimedia file

output.avi (default) | character vector

Specify the name for the multimedia file the block writes. The block appends a file extension automatically based on the specified **File type** parameter. If the specified file name, including the file extension, already exists, the block overwrites the data in the existing file with the new input data.

By default, the block saves the file in the current working directory. To specify a different file location, click the **Save As...** button.

File type — Type of multimedia file

AVI (default) | WAV | MJ2000 | WMA | WMV | MPEG4 | FLAC | OGG

Specify the type of multimedia file to write. The block supports the AVI, WAV, MJ2000, WMA, WMV, MPEG4, FLAC, and OGG file formats.

Write — Type of media

Video only (default) | Audio only | Video and audio

Specify the type of media to write. Depending on the value of the **File type** parameter, you can select Video only, Audio only, or Video and audio.

Type of file	Supported type of media
AVI	<ul style="list-style-type: none"> • Video only • Audio only • Video and audio
WMV	<ul style="list-style-type: none"> • Video only • Video and audio
MPEG4	<ul style="list-style-type: none"> • Video only • Audio only

Dependencies

To enable this parameter, set the **File type** parameter to AVI, WMV, or MPEG4.

Video compressor — Video compression algorithm

None (uncompressed) (default) | DV Video Encoder | MJPEG Compressor | Lossy | Lossless

Specify a video compression algorithm to reduce the size of the output file. The available options depend on the value of the **File type** parameter.

- AVI — Select either the DV Video Encoder or MJPEG Compressor algorithm. If you do not want to reduce the size of the file, select None (uncompressed).

- MJ2000 — Select either the Lossy or Lossless algorithm.

Note The options for this parameter are the video compression algorithms installed on your system. For information about a specific video compressor, see the documentation for that compressor.

Dependencies

To enable this parameter, set the **File type** parameter to MJ2000 or AVI. For the AVI file type, set the **Write** parameter to Video only or Video and audio.

Compression Factor (>1) — Compression factor

10 (default) | integer greater than 1

Specify the compression factor as an integer greater than 1.

Dependencies

To enable this parameter, set the **File type** parameter to MJ2000 and the **Video compressor** parameter to Lossy.

Video Quality (0-100) — Quality of video

75 (default) | integer in range [0, 100]

Specify the quality of the video as an integer in the range [0, 100].

Dependencies

To enable this parameter, set the **File type** parameter to MPEG4 and the **Write** parameter to Video only.

File color format — Color format of output video

RGB (default) | YCbCr 4:2:2

Specify the color format of the video for the output file. The block supports the RGB and YCbCr 4:2:2 color formats.

Dependencies

To enable this parameter, set the **File type** parameter to AVI or MPEG4.

Image signal — Input port configuration for RGB video

One multidimensional signal (default) | Separate color signals

Specify how the block accepts an RGB color video input. If you select One multidimensional signal, the block accepts input using only the **Image** port. If you select Separate color signals, the block accepts an input video using three separate color channels, divided across the **R**, **G**, and **B** ports.

Dependencies

To enable this parameter:

- Set the **File type** parameter to AVI, MJ-2000, WMV, or MPEG4.
- Set the **Write** parameter to Video and audio or Video only.

- If the **File type** parameter value is AVI or MPEG4, set the **File color format** parameter to RGB.

Audio compressor — Audio compression algorithm

None (uncompressed) (default) | CCITT A-Law | CCITT u-Law | GSM 6.10 | IMA ADPCM | Microsoft ADPCM | PCM

Specify an audio compression algorithm to reduce the size of the output file. The block supports the CCITT A-Law, CCITT u-Law, GSM 6.10, IMA ADPCM, Microsoft ADPCM, and PCM algorithms. If you do not want to reduce the size of the file, select None (uncompressed).

Note The options for this parameter are the audio compression algorithms installed on your system. For information about a specific audio compressor, see the documentation for that compressor.

Dependencies

To enable this parameter, use either of these options:

- Set the **File type** parameter to AVI and set the **Write** parameter to Video and audio or Audio only.
- Set the **File type** parameter to WAV.

Audio data type — Audio data type

Determine from input data type (default) | 8-bit integer | 16-bit integer | 24-bit integer | 32-bit integer | 32-bit float | 64-bit float

Specify the audio data type for the output file.

Dependencies

To enable this parameter select, use either of these options:

- Set the **File type** parameter to WAV and the **Audio compressor** parameter to None (uncompressed).
- Set the **File type** parameter to FLAC. This file type supports only the 8-bit integer, 16-bit integer, and 24-bit integer data types.

Block Characteristics

Data Types	double integer ^a single
Direct Feedthrough	no
Multidimensional Signals	no
Variable-Size Signals	no
Zero-Crossing Detection	no

a. Supports 16- and 32-bit signed and 8-bit unsigned integers.

Extended Capabilities

C/C++ Code Generation

Generate C and C++ code using Simulink® Coder™.

Usage notes and limitations:

- Host computer only. Excludes Simulink Desktop Real-Time code generation.
- The executable generated from this block relies on prebuilt dynamic library files (.dll files) included with MATLAB. Use the `packNGo` function to package the code generated from this block and all the relevant files in a compressed ZIP file. Using this ZIP file, you can relocate, unpack, and rebuild your project in another development environment where MATLAB is not installed. For more details, see “Code Generation, GPU, and Third-Party Support” .

See Also

Blocks

[From Multimedia File](#) | [Video From Workspace](#) | [Image From File](#) | [Video To Workspace](#)

Introduced before R2006a

To Video Display

Display images or video frames

Library: Computer Vision Toolbox / Sinks



Description

The To Video Display block displays RGB or YCbCr formatted images and video frames. The display created by the block is lightweight and high performance, capable of displaying high definition video at high frame rates.

Ports

Input

Image — Input image

matrix | array

Input image or video, specified as an M -by- N matrix, M -by- N -by- T array, or M -by- N -by- C -by- T array. If the input is a 3-D array, the third dimension is the number of frames in the video. If the input is a 4-D array, the third dimension is the number of color channels, and the fourth dimension is the number of frames in the video.

Dependencies

To enable this port, set the **Input Color Format** parameter to RGB, and set **Image signal** to One multidimensional signal.

Data Types: single | double | int8 | int16 | int32 | uint8 | uint16 | uint32 | Boolean

R — Red color component of image

matrix | array

Red color component of the input image or video, specified as an M -by- N matrix or M -by- N -by- T array. If the input is a 3-D array, the third dimension is the number of frames in the video.

Note Inputs to the **R**, **G**, and **B** ports must have the same dimensions and data type.

Dependencies

To enable this port, set the **Input Color Format** parameter to RGB, and set **Image signal** to Separate color signals.

Data Types: single | double | int8 | int16 | int32 | uint8 | uint16 | uint32 | Boolean

G — Green color component of image

matrix | array

Green color component of the input image or video, specified as an M -by- N matrix or M -by- N -by- T array. If the input is a 3-D array, the third dimension is the number of frames in the video.

Note Inputs to the **R**, **G**, and **B** ports must have the same dimensions and data type.

Dependencies

To enable this port, set the **Input Color Format** parameter to RGB, and set **Image signal** to **Separate color signals**.

Data Types: single | double | int8 | int16 | int32 | uint8 | uint16 | uint32 | Boolean

B — Blue color component of image

matrix | array

Blue color component of the input image or video, specified as an M -by- N matrix or M -by- N -by- T array. If the input is a 3-D array, the third dimension is the number of frames in the video.

Note Inputs to the **R**, **G**, and **B** ports must have the same dimensions and data type.

Dependencies

To enable this port, set the **Input Color Format** parameter to RGB, and set **Image signal** to **Separate color signals**.

Data Types: single | double | int8 | int16 | int32 | uint8 | uint16 | uint32 | Boolean

Y — Luma component of image

matrix | array

Luma component of the input image or video, specified as an M -by- N matrix or M -by- N -by- T array. If the input is a 3-D array, the third dimension is the number of frames in the video.

Dependencies

To enable this port, set the **Input Color Format** parameter to YCbCr 4:2:2.

Data Types: single | double | int8 | int16 | int32 | uint8 | uint16 | uint32 | Boolean

Cb — Blue-difference chroma component of image

matrix | array

Blue-difference chroma component of the input image or video, specified as an M -by- $N/2$ matrix or M -by- $N/2$ -by- T array. If the input is a 3-D array, the third dimension is the number of frames in the video.

Dependencies

To enable this port, set the **Input Color Format** parameter to YCbCr 4:2:2.

Data Types: single | double | int8 | int16 | int32 | uint8 | uint16 | uint32 | Boolean

Cr — Red-difference chroma component of image

matrix | array

Red-difference chroma component of the input image or video, specified as an M -by- $N/2$ matrix or M -by- $N/2$ -by- T array. If the input is a 3-D array, the third dimension is the number of frames in the video.

Dependencies

To enable this port, set the **Input Color Format** parameter to YCbCr 4:2:2.

Data Types: single | double | int8 | int16 | int32 | uint8 | uint16 | uint32 | Boolean

Parameters**View****Window size — Display window size**

Normal (default) | Full-screen (Esc to exit) | True size (1:1)

Display the video stream in various window sizes:

- **Normal** — Modify the display size at the start of the simulation.
- **Full-screen (Esc to exit)** — Display the video stream in a full-screen window. To exit the full-screen view, press **Esc**.
- **True size (1:1)** — Display the input image at a one-to-one pixel ratio, at the start of the simulation.

Open at Start of Simulation — Open window at start of simulation

on (default) | off

To set the **Video Display** window to open automatically and display video frames when the simulation begins, select **Open at Start of Simulation**. If you clear this parameter, the block is not included during runtime, and the simulation runs in “Accelerator Mode” (Simulink).

Settings**Input Color Format — Input color format**

RGB (default) | YCbCr 4:2:2

Specify the color format of the input image:

- **RGB** — Specify the input colorspace as RGB. You can select whether to input the image as a single signal or as individual color signals using the **Image signal** parameter.
- **YCbCr 4:2:2**— Specify the input colorspace as YCbCr. You must input the image as separate signals to the three input ports, **Y**, **Cb** and **Cr**.

Image signal — Configure input port

One multidimensional signal (default) | Separate color signals

Specify whether the block accepts an RGB color input as a single signal or as separate signals for each color channel..

- **One multidimensional signal** — The block accepts RGB input as a single array through one port.

- **Separate color signals** — The block accepts RGB input as three separate matrices or arrays, one for each color channel, to the **R**, **G**, and **B** ports.

Dependencies

To enable this parameter, set the **Input Color Format** parameter to RGB.

Block Characteristics

Data Types	Boolean double integer single
Multidimensional Signals	yes
Variable-Size Signals	yes

Extended Capabilities

C/C++ Code Generation

Generate C and C++ code using Simulink® Coder™.

Note This block supports code generation for platforms that have file I/O available. You cannot use this block with Simulink Desktop Real-Time software, because that product does not support file I/O.

The generated code for this block relies on prebuilt library files. You can run this code outside the MATLAB environment, or redeploy it, but be sure to account for these extra library files when doing so. The `packNGo` function creates a single ZIP file containing all of the pieces required to run or rebuild this code. See `packNGo` for more information.

To know the code generation process of Simulink blocks, see “Simulink Coder”. To run an executable file that was generated from a model containing this block, you may need to add precompiled shared library files to your system path. See “Simulink Shared Library Dependencies” and “Accelerating Simulink Models” for details.

Usage notes and limitations:

- Host computer only. Excludes Simulink Desktop Real-Time code generation.
- The executable generated from this block relies on prebuilt dynamic library files (.dll files) included with MATLAB. Use the `packNGo` function to package the code generated from this block and all the relevant files in a compressed ZIP file. Using this ZIP file, you can relocate, unpack, and rebuild your project in another development environment where MATLAB is not installed. For more details, see “Code Generation, GPU, and Third-Party Support”.

See Also

Blocks

Frame Rate Display | From Multimedia File | To Multimedia File | Video To Workspace | Video Viewer

Introduced before R2006a

Top-hat

Perform top-hat filtering on intensity or binary images



Library

Morphological Operations

visionmorphops

Description

The Top-hat block performs top-hat filtering on an intensity or binary image using a predefined neighborhood or structuring element. Top-hat filtering is the equivalent of subtracting the result of performing a morphological opening operation on the input image from the input image itself. This block uses flat structuring elements only.

Port	Input/Output	Supported Data Types	Complex Values Supported
	Vector or matrix of intensity values	<ul style="list-style-type: none"> • Double-precision floating point • Single-precision floating point • Fixed point • Boolean • 8-, 16-, and 32-bit signed integer • 8-, 16-, and 32-bit unsigned integer 	No
Nhood	Matrix or vector of 1s and 0s that represents the neighborhood values	Boolean	No
Output	Scalar, vector, or matrix that represents the filtered image	Same as I port	No

If your input image is a binary image, for the **Input image type** parameter, select **Binary**. If your input image is an intensity image, select **Intensity**.

Use the **Neighborhood or structuring element source** parameter to specify how to enter your neighborhood or structuring element values. If you select **Specify via dialog**, the **Neighborhood or structuring element** parameter appears in the dialog box. If you select **Input port**, the Nhood port appears on the block. Use this port to enter your neighborhood values as a matrix or vector of 1s and 0s. Choose your structuring element so that it matches the shapes you want to remove from your image. You can only specify a it using the dialog box.

Use the **Neighborhood or structuring element** parameter to define the region the block moves throughout the image. Specify a neighborhood by entering a matrix or vector of 1s and 0s. Specify a structuring element with the `strel` function from the Image Processing Toolbox. If the structuring

element is decomposable into smaller elements, the block executes at higher speeds due to the use of a more efficient algorithm.

Parameters

Input image type

If your input image is a binary image, select **Binary**. If your input image is an intensity image, select **Intensity**.

Neighborhood or structuring element source

Specify how to enter your neighborhood or structuring element values. Select **Specify via dialog** to enter the values in the dialog box. Select **Input port** to use the Nhood port to specify the neighborhood values. You can only specify a structuring element using the dialog box.

Neighborhood or structuring element

If you are specifying a neighborhood, this parameter must be a matrix or vector of 1s and 0s. If you are specifying a structuring element, use the `strel` function from the Image Processing Toolbox. This parameter is visible if, for the **Neighborhood or structuring element source** parameter, you select **Specify via dialog**.

See Also

Bottom-hat	Computer Vision Toolbox software
Closing	Computer Vision Toolbox software
Dilation	Computer Vision Toolbox software
Erosion	Computer Vision Toolbox software
Label	Computer Vision Toolbox software
Opening	Computer Vision Toolbox software
<code>imtophat</code>	Image Processing Toolbox software
<code>strel</code>	Image Processing Toolbox software

Extended Capabilities

C/C++ Code Generation

Generate C and C++ code using Simulink® Coder™.

Introduced before R2006a

Trace Boundary

Trace object boundaries in binary images

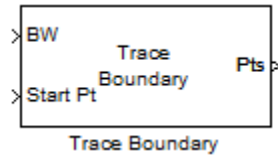

Library

Analysis & Enhancement

visionanalysis

Description

The Trace Boundary block traces object boundaries in binary images, where nonzero pixels represent objects and 0 pixels represent the background.

Port Descriptions

Port	Input/Output	Supported Data Types
BW	Vector or matrix that represents a binary image	Boolean
Start Pt	One-based [x y] coordinates of the boundary starting point.	<ul style="list-style-type: none"> • Double-precision floating point • Single-precision floating point • 8-, 16-, and 32-bit signed integer • 8-, 16-, and 32-bit unsigned integer

Port	Input/Output	Supported Data Types
Pts	<p>M-by-2 matrix of $[x\ y]$ coordinates of the boundary points, where M represents the number of traced boundary pixels. M must be less than or equal to the value specified by the Maximum number of boundary pixels parameter.</p> $\begin{bmatrix} x_1 & y_1 \\ x_2 & y_2 \\ x_3 & y_3 \\ \cdot & \cdot \\ \cdot & \cdot \\ \cdot & \cdot \\ x_m & y_m \end{bmatrix}$	Same as Start Pts port

Parameters

Connectivity

Specify which pixels are connected to each other. If you want a pixel to be connected to the pixels on the top, bottom, left, and right, select 4. If you want a pixel to be connected to the pixels on the top, bottom, left, right, and diagonally, select 8. For more information about this parameter, see the Label block reference page.

Initial search direction

Specify the first direction in which to look to find the next boundary pixel that is connected to the starting pixel.

If, for the **Connectivity** parameter, you select 4, the following figure illustrates the four possible initial search directions:

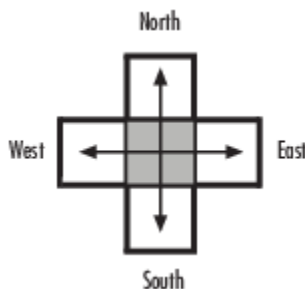

If, for the **Connectivity** parameter, you select 8, the following figure illustrates the eight possible initial search directions:

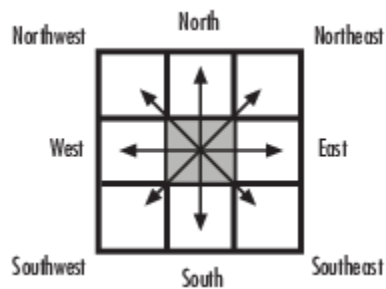

Trace direction

Specify the direction in which to trace the boundary. Your choices are **Clockwise** or **Counterclockwise**.

Maximum number of boundary pixels

Specify the maximum number of boundary pixels for each starting point. The block uses this value to preallocate the number of rows of the **Pts** port output matrix so that it can hold all the boundary pixel location values.

Use the **Maximum number of boundary pixels** parameter to specify the maximum number of boundary pixels for the starting point.

See Also

Edge Detection	Computer Vision Toolbox software
Label	Computer Vision Toolbox software
bwboundaries	Image Processing Toolbox software
bwtraceboundary	Image Processing Toolbox software

Extended Capabilities

C/C++ Code Generation

Generate C and C++ code using Simulink® Coder™.

Introduced in R2011b

Translate

Translate image in 2-D plane using displacement vector

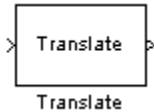

Library

Geometric Transformations

visiongeotforms

Description

Use the Translate block to move an image in a two-dimensional plane using a displacement vector, a two-element vector that represents the number of pixels by which you want to translate your image. The block outputs the image produced as the result of the translation.

Note This block supports intensity and color images on its ports.

Port	Input/Output	Supported Data Types	Complex Values Supported
Image / Input	M-by-N matrix of intensity values or an M-by-N-by-P color video signal where P is the number of color planes	<ul style="list-style-type: none"> Double-precision floating point Single-precision floating point Fixed point 8-, 16-, 32-bit signed integer 8-, 16-, 32-bit unsigned integer 	No
Offset	Vector of values that represent the number of pixels by which to translate the image	Same as I port	No
Output	Translated image	Same as I port	No

The input to the Offset port must be the same data type as the input to the Image port. The output is the same data type as the input to the Image port.

Use the **Output size after translation** parameter to specify the size of the translated image. If you select **Full**, the block outputs a matrix that contains the entire translated image. If you select **Same as input image**, the block outputs a matrix that is the same size as the input image and contains a portion of the translated image. Use the **Background fill value** parameter to specify the pixel values outside the image.

Use the **Offset source** parameter to specify how to enter your displacement vector. If you select **Specify via dialog**, the **Offset** parameter appears in the dialog box. Use it to enter your

displacement vector, a two-element vector, $[r \ c]$, of real, integer values that represent the number of pixels by which you want to translate your image. The r value represents how many pixels up or down to shift your image. The c value represents how many pixels left or right to shift your image. The axis origin is the top-left corner of your image. For example, if you enter $[2.5 \ 3.2]$, the block moves the image 2.5 pixels downward and 3.2 pixels to the right of its original location. When the displacement vector contains fractional values, the block uses interpolation to compute the output.

Use the **Interpolation method** parameter to specify which interpolation method the block uses to translate the image. If you translate your image in either the horizontal or vertical direction and you select **Nearest neighbor**, the block uses the value of the nearest pixel for the new pixel value. If you translate your image in either the horizontal or vertical direction and you select **Bilinear**, the new pixel value is the weighted average of the four nearest pixel values. If you translate your image in either the horizontal or vertical direction and you select **Bicubic**, the new pixel value is the weighted average of the sixteen nearest pixel values.

The number of pixels the block considers affects the complexity of the computation. Therefore, the nearest-neighbor interpolation is the most computationally efficient. However, because the accuracy of the method is roughly proportional to the number of pixels considered, the bicubic method is the most accurate.

If, for the **Output size after translation** parameter, you select **Full**, and for the **Offset source** parameter, you select **Input port**, the **Maximum offset** parameter appears in the dialog box. Use the **Maximum offset** parameter to enter a two-element vector of real, scalar values that represent the maximum number of pixels by which you want to translate your image. The block uses this parameter to determine the size of the output matrix. If the input to the Offset port is greater than the **Maximum offset** parameter values, the block saturates to the maximum values.

If, for the **Offset source** parameter, you select **Input port**, the Offset port appears on the block. At each time step, the input to the Offset port must be a vector of real, scalar values that represent the number of pixels by which to translate your image.

Fixed-Point Data Types

The following diagram shows the data types used in the Translate block for bilinear interpolation of fixed-point signals.

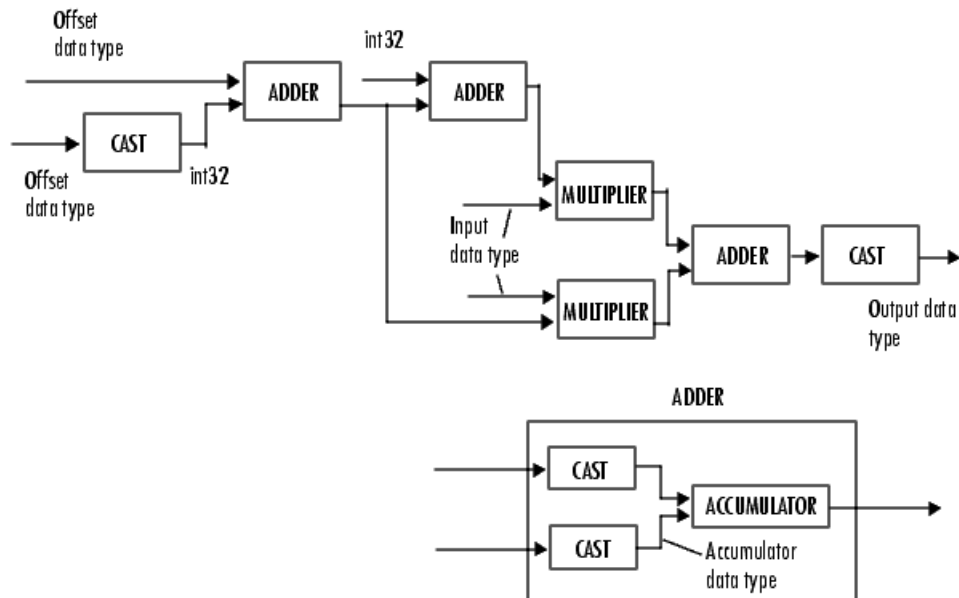

You can set the product output, accumulator, and output data types in the block mask as discussed in the next section.

Parameters

Output size after translation

If you select **Full**, the block outputs a matrix that contains the translated image values. If you select **Same as input image**, the block outputs a matrix that is the same size as the input image and contains a portion of the translated image.

Offset source

Specify how to enter your translation parameters. If you select **Specify via dialog**, the **Offset** parameter appears in the dialog box. If you select **Input port**, port 0 appears on the block. The block uses the input to this port at each time step as your translation values.

Offset source

Enter a vector of real, scalar values that represent the number of pixels by which to translate your image.

Background fill value

Specify a value for the pixels that are outside the image.

Interpolation method

Specify which interpolation method the block uses to translate the image. If you select **Nearest neighbor**, the block uses the value of one nearby pixel for the new pixel value. If you select **Bilinear**, the new pixel value is the weighted average of the four nearest pixel values. If you select **Bicubic**, the new pixel value is the weighted average of the sixteen nearest pixel values.

The number of pixels the block considers affects the complexity of the computation. Therefore, the **Nearest-neighbor** interpolation is the most computationally efficient. However, because the accuracy of the method is proportional to the number of pixels considered, the **Bicubic** method is the most accurate.

Maximum offset

Enter a vector of real, scalar values that represent the maximum number of pixels by which you want to translate your image. This parameter must have the same data type as the input to the Offset port. This parameter is visible if, for the **Output size after translation** parameter, you select Full and, for the **Offset source** parameter, you select Input port.

Rounding mode

Select the rounding mode for fixed-point operations.

Overflow mode

Select the overflow mode for fixed-point operations.

Offset values

Choose how to specify the word length and the fraction length of the offset values.

- When you select **Same word length as input**, the word length of the offset values match that of the input to the block. In this mode, the fraction length of the offset values is automatically set to the binary-point only scaling that provides you with the best precision possible given the value and word length of the offset values.
- When you select **Specify word length**, you can enter the word length of the offset values, in bits. The block automatically sets the fraction length to give you the best precision.
- When you select **Binary point scaling**, you can enter the word length and the fraction length of the offset values, in bits.
- When you select **Slope and bias scaling**, you can enter the word length, in bits, and the slope of the offset values. The bias of all signals in the Computer Vision Toolbox blocks is 0.

This parameter is visible if, for the **Offset source** parameter, you select Specify via dialog.

Product output

As depicted in the previous figure, the output of the multiplier is placed into the product output data type and scaling. Use this parameter to specify how to designate this product output word and fraction lengths.

- When you select **Same as first input**, these characteristics match those of the first input to the block.
- When you select **Binary point scaling**, you can enter the word length and the fraction length of the product output, in bits.
- When you select **Slope and bias scaling**, you can enter the word length, in bits, and the slope of the product output. The bias of all signals in the Computer Vision Toolbox blocks is 0.

Accumulator

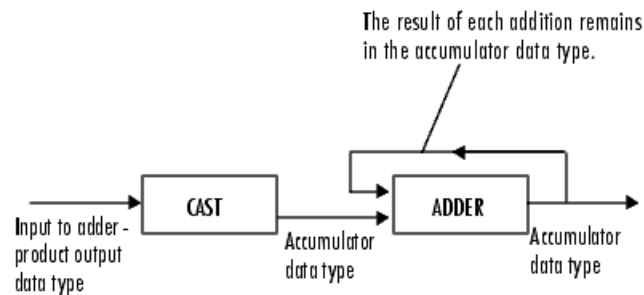

As depicted in the previous figure, inputs to the accumulator are cast to the accumulator data type. The output of the adder remains in the accumulator data type as each element of the input is added to it. Use this parameter to specify how to designate this accumulator word and fraction lengths.

- When you select **Same as product output**, these characteristics match those of the product output.
- When you select **Same as first input**, these characteristics match those of the first input to the block.
- When you select **Binary point scaling**, you can enter the word length and the fraction length of the accumulator, in bits.
- When you select **Slope and bias scaling**, you can enter the word length, in bits, and the slope of the accumulator. The bias of all signals in the Computer Vision Toolbox blocks is 0.

Output

Choose how to specify the word length and fraction length of the output of the block:

- When you select **Same as first input**, these characteristics match those of the first input to the block.
- When you select **Binary point scaling**, you can enter the word length and the fraction length of the output, in bits.
- When you select **Slope and bias scaling**, you can enter the word length, in bits, and the slope of the output. The bias of all signals in the Computer Vision Toolbox blocks is 0.

Lock data type settings against change by the fixed-point tools

Select this parameter to prevent the fixed-point tools from overriding the data types you specify on the block mask. For more information, see `fxptdlg`, a reference page on the Fixed-Point Tool in the Simulink documentation.

References

- [1] Wolberg, George. *Digital Image Warping*. Washington: IEEE Computer Society Press, 1990.

See Also

Resize	Computer Vision Toolbox software
Rotate	Computer Vision Toolbox software
Shear	Computer Vision Toolbox software

More About

Nearest Neighbor Interpolation Method

For nearest neighbor interpolation, the block uses the value of nearby translated pixel values for the output pixel values.

For example, suppose this matrix,

```
1 2 3
4 5 6
7 8 9
```

represents your input image. You want to translate this image 1.7 pixels in the positive horizontal direction using nearest neighbor interpolation. The block's nearest neighbor interpolation algorithm is illustrated by the following steps:

- 1 Zero pad the input matrix and translate it by 1.7 pixels to the right.

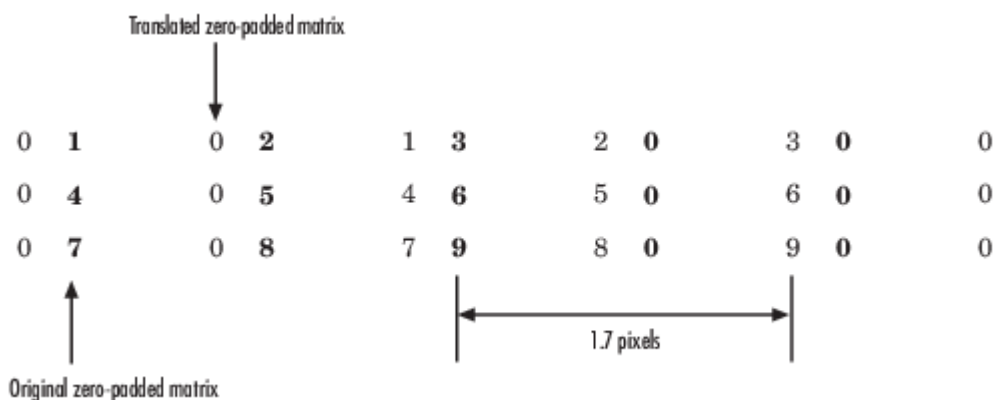

- 2 Create the output matrix by replacing each input pixel value with the translated value nearest to it. The result is the following matrix:

```
0 0 1 2 3
0 0 4 5 6
0 0 7 8 9
```

Note You wanted to translate the image by 1.7 pixels, but this method translated the image by 2 pixels. Nearest neighbor interpolation is computationally efficient but not as accurate as bilinear or bicubic interpolation methods.

Bilinear Interpolation

For bilinear interpolation, the block uses the weighted average of two translated pixel values for each output pixel value.

For example, suppose this matrix,

```
1 2 3
4 5 6
7 8 9
```

represents your input image. You want to translate this image 0.5 pixel in the positive horizontal direction using bilinear interpolation. The block's bilinear interpolation algorithm is illustrated by the following steps:

- 1 Zero pad the input matrix and translate it by 0.5 pixel to the right.

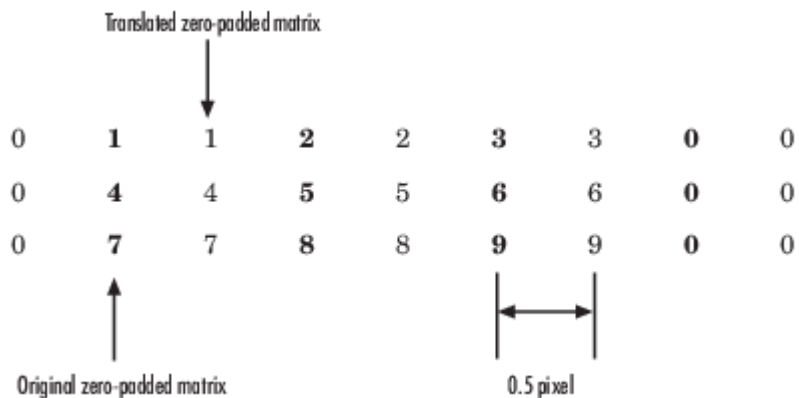

- 2 Create the output matrix by replacing each input pixel value with the weighted average of the translated values on either side. The result is the following matrix where the output matrix has one more column than the input matrix:

```
0.5 1.5 2.5 1.5
  2  4.5 5.5  3
 3.5 7.5 8.5 4.5
```

Bicubic Interpolation

For bicubic interpolation, the block uses the weighted average of four translated pixel values for each output pixel value.

For example, suppose this matrix,

```
1 2 3
4 5 6
7 8 9
```

represents your input image. You want to translate this image 0.5 pixel in the positive horizontal direction using bicubic interpolation. The block's bicubic interpolation algorithm is illustrated by the following steps:

- 1 Zero pad the input matrix and translate it by 0.5 pixel to the right.

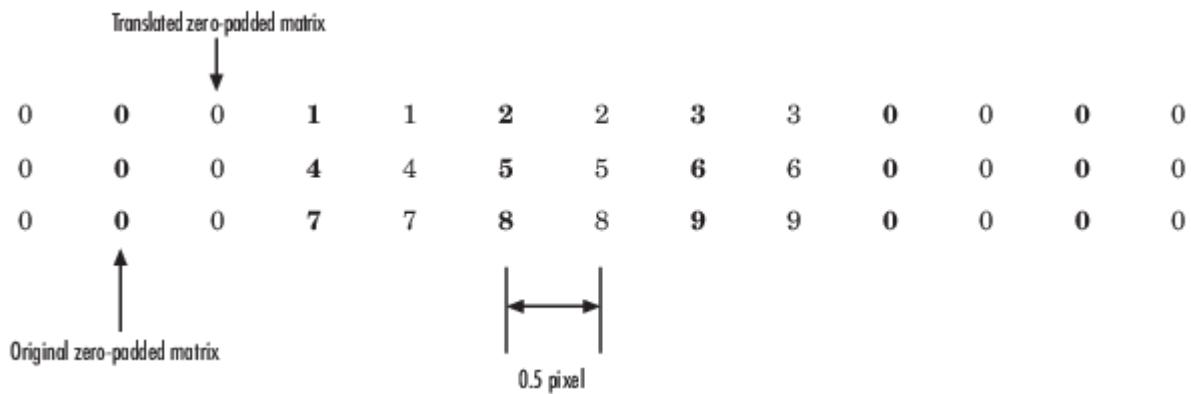

- 2 Create the output matrix by replacing each input pixel value with the weighted average of the two translated values on either side. The result is the following matrix where the output matrix has one more column than the input matrix:

```
0.375 1.5 3 1.625
1.875 4.875 6.375 3.125
3.375 8.25 9.75 4.625
```

Extended Capabilities

C/C++ Code Generation

Generate C and C++ code using Simulink® Coder™.

Introduced before R2006a

Video Viewer

Display images or video frames

Library: Computer Vision Toolbox / Sinks



Description

The Video Viewer block displays images or video frames. This block provides simulation controls to play, pause, and step while streaming a video or image sequence. This block also provides tools to analyze the pixels of a region of interest.

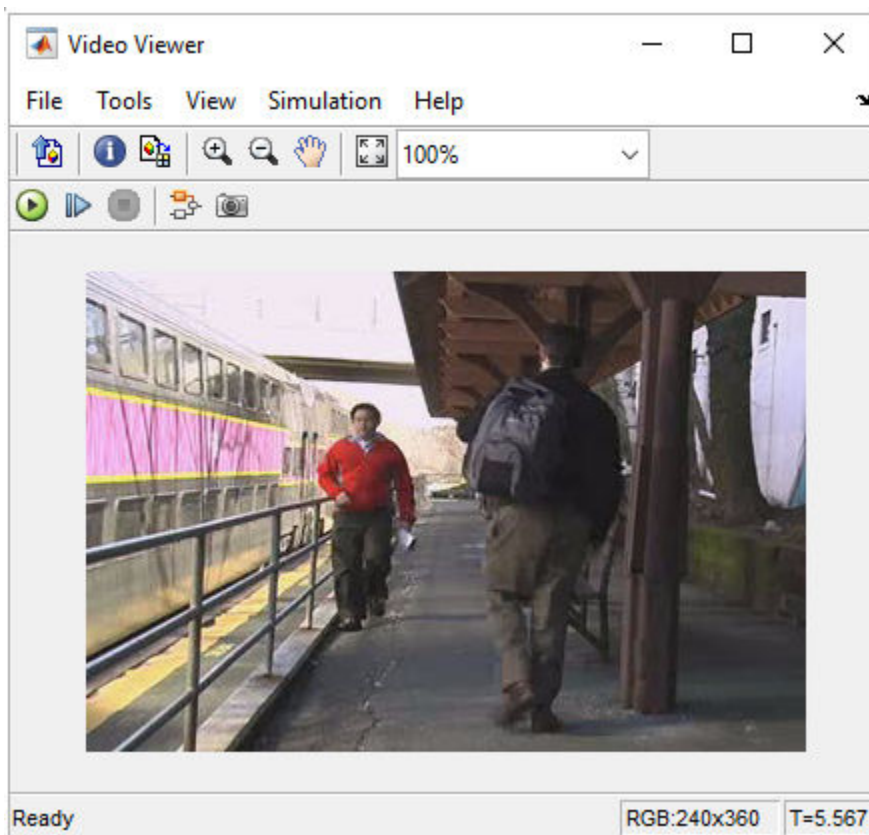

Features of Video Viewer

- Playback control — Control video playback using the Run, Step Forward, and Stop buttons.
- Export to **Image Viewer** — To open the displayed image in a separate window using the **Image Viewer** app, select **File > Export to Image Tool**. Alternatively, select the Export to Image Tool button in the toolbar. For more information, see “Get Started with Image Viewer App”.

- Pixel region analysis— To open the displayed image in a separate window using the Pixel Region tool, select **Tools > Pixel Region**. Alternatively, select the Inspect pixel values button in the toolbar. For more information about Pixel Region tool, see `impixelregion`.

Ports

Input

Image — Input image or video

matrix | array

Input image or video, specified as an M -by- N matrix, M -by- N -by- T array, or M -by- N -by- C -by- T array. T is the number of frames in a video or image sequence, and C is the number of color channels.

Dependencies

To enable this port, select the **One Multi-Dimensional Signal** parameter. This parameter is enabled by default.

Data Types: `single` | `double` | `int8` | `int16` | `int32` | `uint8` | `uint16` | `uint32` | `Boolean` | `Simulink.ImageType`

R — Red color component of image or video

matrix | array

Red color component of the image or video, specified as an M -by- N matrix or M -by- N -by- T array. T is the number of frames in a video or image sequence.

Note Inputs to the **R**, **G**, and **B** ports must all have the same dimensions and data type.

Dependencies

To enable this port, select the **Separate Color Signals** parameter.

Data Types: `single` | `double` | `int8` | `int16` | `int32` | `uint8` | `uint16` | `uint32` | `Boolean`

G — Green color component of image or video

matrix | array

Green color component of the image or video, specified as an M -by- N matrix or M -by- N -by- T array. T is the number of frames in a video or image sequence.

Note Inputs to the **R**, **G**, and **B** ports must all have the same dimensions and data type.

Dependencies

To enable this port, select the **Separate Color Signals** parameter.

Data Types: `single` | `double` | `int8` | `int16` | `int32` | `uint8` | `uint16` | `uint32` | `Boolean`

B — Blue color component of image or video

matrix | array

Blue color component of the image or video, specified as an M -by- N matrix or M -by- N -by- T array. T is the number of frames in a video or image sequence.

Note Inputs to the **R**, **G**, and **B** ports must all have the same dimensions and data type.

Dependencies

To enable this port, select the **Separate Color Signals** parameter.

Data Types: `single` | `double` | `int8` | `int16` | `int32` | `uint8` | `uint16` | `uint32` | `Boolean`

Parameters

File

To access these parameters, select the **File** menu in the Video Viewer window

Open at Start of Simulation — Open video viewer window at start of simulation

`on` (default) | `off`

Select this parameter to automatically open the Video Viewer window at the start of the simulation. Clear this parameter to prevent the Video Viewer window from opening at the start of the simulation.

Separate Color Signals — Enable separate R, G, and B color channels as input

`off` (default) | `on`

Select this parameter to enable the **R**, **G**, and **B** input ports for separate color channels. If you select this parameter, the **One Multi-Dimensional Signal** parameter clears automatically.

One Multi-Dimensional Signal — Enable one multi-dimensional signal as input

`on` (default) | `off`

Select this parameter to enable the **Image** input port for one multi-dimensional signal. If you select this parameter, the **Separate Color Signals** parameter clears automatically.

File > Configuration > Edit > Core

The Video Viewer **Configuration** parameters enable you to change the behavior and appearance of the graphic user interface (GUI).

- To open the Configuration dialog box and edit parameters, select **File > Configuration > Edit**.

The **Core** tab in the Configuration dialog box lists the general settings of the GUI.

- In the **Core** tab, select **General UI** item and click the **Properties** button to open the General UI Properties dialog box.

Display the full path — Display full path of source data in the title bar

`off` (default) | `on`

Select this parameter to display the model name and full path to the source data in the title bar of the Video Viewer window. If you clear this parameter, the window displays a shortened name.

File > Configuration > Edit > Tools

The Video Viewer **Configuration** parameters enable you to change the behavior and appearance of the graphic user interface (GUI).

- To open the Configuration dialog box and edit parameters, select **File > Configuration > Edit**.

The **Tools** tab in the Configuration dialog box lists the tools associated with the Video Viewer block.

- In the **Tools** tab, select the **Image Tool** item and click the **Properties** button to open the Image Tool Properties dialog box.

Open new Image Tool window for each export — Open new Image Viewer window for each exported video frame

on (default) | off

Select this parameter to open a new **Image Viewer** window for each exported video frame or image in an image sequence..

Tools > Colormap

The **Colormap** parameters enable you to display an intensity image in various colormap formats and control the output intensity range. To access these parameters, select **Tools > Colormap** or press **C**.

Note The **Colormap** parameters are available for intensity images only.

Colormap — Set colormap

gray(256) (default) | parula(256) | jet(256) | hot(256) | bone(256) | cool(256) | copper(256)

This parameter specifies the colormap in which to display the input intensity image. This block supports the gray(256), parula(256), jet(256), hot(256), bone(256), and copper(256) colormaps.

Specify range of displayed pixel values [-Inf to Inf] — Specify range of intensity value to display

off (default) | on

Select this parameter to enable the **Min** and **Max** parameters, through which you can specify the display range of pixel intensities.

Min — Minimum intensity value

0 (default) | numeric scalar

If a pixel has an intensity value less than or equal to the value of this parameter, **Video Viewer** displays it as the first color in the selected colormap.

Note When specifying a value for **Min**, remember that the data type of the input image or video determines the range of intensity values representing that image or video.

Dependencies

To enable this parameter, select the **Specify range of displayed pixel values [-Inf to Inf]** parameter.

Max — Maximum intensity value

255 (default) | numeric scalar

If a pixel has an intensity value higher than or equal to the value of this parameter, **Video Viewer** displays it as the last color in the selected colormap.

Note When specifying a value for **Max**, remember that the data type of the input image or video determines the range of intensity values representing that image or video.

Dependencies

To enable this parameter, select the **Specify range of displayed pixel values [-Inf to Inf]** parameter.

Simulation

To access this parameter, select the **Simulation** menu in the Video Viewer window.

Drop Frames to Improve Performance — Drop frame rate of input video signal

on (default) | off

Select this parameter to reduce the frame rate of the input video signal to improve performance.

Block Characteristics

Data Types	Boolean double integer single
Direct Feedthrough	no
Multidimensional Signals	no
Variable-Size Signals	yes
Zero-Crossing Detection	no

See Also**Blocks**

From Multimedia File | To Multimedia File | To Video Display | Video To Workspace | Video From Workspace | Image From Workspace | Image From File

Introduced before R2006a

Video From Workspace

Import video from MATLAB workspace

Library: Computer Vision Toolbox / Sources

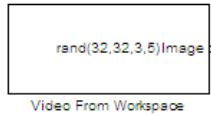

Description

The Video From Workspace block imports a video from the MATLAB workspace. The output of the block depends on the format of the video in the workspace.

- If the video is represented by an M -by- N -by- T array, the block outputs a grayscale video. M and N are the number of rows and columns in each video frame, and T is the number of frames in the video.
- If the video is represented by an M -by- N -by- C -by- T array, the block outputs a color video. M and N are the number of rows and columns in each video frame, C is the number of color channels, and T is the number of frames in the video.

Note

- If you generate code from a model that contains this block, it takes long to compile the code as the Simulink Coder puts all of the video data into the `.c` file. To shorten code generation time, convert your video data into a format supported by the From Multimedia File or Read Binary File block.
 - The Video From Workspace block also supports `fi` objects. For more information on `fi` objects, see `fi` Object Properties (Fixed-Point Designer).
-

Ports

Output

Image — Output image or video

M -by- N -by- T array | M -by- N -by- C -by- T array

Output image or video, returned as an M -by- N -by- T array or M -by- N -by- C -by- T array. If the output is a 3-D array, the third dimension is the number of frames in the video. If the output is a 4-D array, the third dimension is the number of color channels, and the fourth dimension is the number of frames in the video.

Note If an RGB image of size, M -by- N -by-3 array is imported from the MATLAB workspace, the block considers the third dimension to be the number of frames and processes the image as a grayscale video with 3 identical frames.

Data Types: `single` | `double` | `int8` | `int16` | `int32` | `uint8` | `uint16` | `uint32` | `Boolean` | `fixed point`

R — Red color component of input video

3-D array

Red color component of the input video, returned as a 3-D array. The third dimension is the number of frames in the input video.

Note The port label can be changed by using the **Output port labels** parameter.

Dependencies

To enable this port, set the **Image signal** parameter to `Separate color signals`.

Data Types: `single` | `double` | `int8` | `int16` | `int32` | `uint8` | `uint16` | `uint32` | `Boolean` | `fixed point`

G — Green color component of input video

3-D array

Green color component of the input video, returned as a 3-D array. The third dimension is the number of frames in the input video.

Note The port label can be changed by using the **Output port labels** parameter.

Dependencies

To enable this port, set the **Image signal** parameter to `Separate color signals`.

Data Types: `single` | `double` | `int8` | `int16` | `int32` | `uint8` | `uint16` | `uint32` | `Boolean` | `fixed point`

B — Blue color component of input video

3-D array

Blue color component of the input video, returned as a 3-D array. The third dimension is the number of frames in the input video.

Note The port label can be changed by using the **Output port labels** parameter.

Dependencies

To enable this port, set the **Image signal** parameter to `Separate color signals`.

Data Types: `single` | `double` | `int8` | `int16` | `int32` | `uint8` | `uint16` | `uint32` | `Boolean` | `fixed point`

Parameters**Signal — Video to read**

`rand(32, 32, 3, 5)` (default) | *M-by-N-by-T* array | *M-by-N-by-C-by-T* array | MATLAB workspace variable

Specify the video to read from the workspace. The value for this parameter can be a 3-D numeric array, 4-D numeric array, or a MATLAB workspace variable.

To import an AVI file from the MATLAB workspace, use this process.

- 1 Read the file by using the `VideoReader` function.

```
mov = VideoReader('filename.avi')
```

- 2 Specify the workspace variable, in this case `mov` as the value for the **Signal** parameter. If the AVI file has an associated colormap, it must satisfy these conditions.

- The colormap must be empty or have 256 values.
- The data must represent a grayscale image.
- The data type of the pixel values must be `uint8`.

Sample time — Sample period of the output video

1 (default) | -1 | positive scalar

This parameter specifies the sample period of the output video as a positive scalar or -1. When set to -1, the block inherits the sample time from the simulink model.

Form output after final value by — Form of block output after final video frame

Setting to zero (default) | Holding final value | Cyclic repetition

Specify the block output for the duration of the simulation after the block generates the final video frame.

- **Setting to zero** — Generate zero-valued outputs.
- **Holding final value** — Repeat the final frame.
- **Cyclic repetition** — Repeat the video from the beginning.

Image signal — Output mode of video signal

One multidimensional signal (default) | Separate color signals

Specify the format in which the block returns a color video.

- **One multidimensional signal** — Return all color channels of the video in a single 4-D array. The third dimension is the number of color channels in the video.
- **Separate color signals** — Return each color channel of the video as a separate 3-D array. This setting enables a number of output ports on the block equal to the number of color channels in the video. Each port returns a single color channel.

Output port labels — Output port names

R|G|B (default) | text labels separated by vertical bars

Name the output ports. Use the vertical bar character, `|`, as a delimiter.

Example:: Red|Green|Blue

Dependencies

To enable this parameter, set the **Image signal** parameter to `Separate color signals`.

Block Characteristics

Data Types	Boolean double fixed point integer single
Multidimensional Signals	yes
Variable-Size Signals	no

Extended Capabilities

C/C++ Code Generation

Generate C and C++ code using Simulink® Coder™.

See Also

Blocks

[Video To Workspace](#) | [Image From Workspace](#) | [Video Viewer](#)

Introduced before R2006a

Video To Workspace

Export image or video to MATLAB workspace

Library: Computer Vision Toolbox / Sinks



Description

The Video To Workspace block exports an image or video to the MATLAB workspace. It accepts images or videos as a matrix, 3-D array, 4-D array and converts them to a 3-D or 4-D array. The input size determines the output size.

- M -by- N , the block exports it as an M -by- N -by-2 array. M and N are the number of rows and columns, respectively, in an image frame and 2 is the number of frames in the image.
- M -by- N -by-3, the block exports it as a M -by- N -by-3-by-2 array. M and N are the number of rows and columns in a image or video frame, 3 is the number of color channels, and 2 is the number of frames in the video.
- M -by- N -by-3-by- T , the block exports it as a M -by- N -by-3-by- T array. M and N are the number of rows and columns in a video frame, 3 represents the number of color channels, and T is the number of frames in the video.

Note

- Simulink Coder does not generate code for this block.
 - The block supports grayscale and color images, which are exported to the MATLAB workspace with an extra dimension that represents the number of frames. An image is always exported with a frame value of 2.
-

Ports

Input

Image — Input video

matrix | 3-D array | 4-D array

The input image or video, specified as a matrix, 3-D array, or 4-D array. The type of signal determines the dimensions of the input. Inputs are defined in terms of M , N , C , and T . M and N are the number of rows and columns in the signal respectively. C is the number of color channels in the signal, and T is the number of frames.

Input - Output

Signal Type	Input Dimensions	Output Dimensions
Grayscale image	M -by- N	M -by- N -by-2
Color image	M -by- N -by-3	M -by- N -by-3-by-2
Grayscale video	M -by- N -by- T	M -by- N -by- T
Color video	M -by- N -by-3-by- T	M -by- N -by-3-by- T

Data Types: single | double | int8 | int16 | int32 | uint8 | uint16 | uint32 | Boolean | fixed point

R — Red color channel

scalar | vector | matrix

Red color channel of the input image or video, specified as a scalar, vector, or matrix.

Note The port label can be changed using the `Input port labels` parameter.

Dependencies

To enable this port, set the **Number of inputs** parameter to a value greater than or equal to 2.

Data Types: single | double | int8 | int16 | int32 | uint8 | uint16 | uint32 | Boolean | fixed point

G — Green color channel

scalar | vector | matrix

Green color channel of the input image or video, specified as a scalar, vector, or matrix.

Note The port label can be changed using the `Input port labels` parameter.

Dependencies

To enable this port, set the **Number of inputs** parameter to a value greater than or equal to 2.

Data Types: single | double | int8 | int16 | int32 | uint8 | uint16 | uint32 | Boolean | fixed point

B — Blue color channel

scalar | vector | matrix

Blue color component of the input image or video, specified as a scalar, vector, or matrix.

Note The port label can be changed using the `Input port labels` parameter.

Dependencies

To enable this port, set the **Number of inputs** parameter to a value equal to 3.

Data Types: single | double | int8 | int16 | int32 | uint8 | uint16 | uint32 | Boolean | fixed point

Parameters

Variable name — MATLAB workspace variable name

vout (default) | valid MATLAB variable name

Specify the MATLAB workspace variable name for the exported image or video.

Number of inputs — Number of inputs ports

1 (default) | positive integer

Specify the number of inputs to the block. To separate the color channels in a RGB image or video, specify the number of channels. If it is a grayscale video, enter 1. If it is a color (R, G, B) video, enter 3.

Limit data points to last — Maximum number of frames to export

10 (default) | positive integer

Specify the maximum number of frames to export to the MATLAB workspace.

Decimation — Downsample video signal

1 (default) | positive integer

Enter the decimation factor by which to downsample the image or video.

Log fixed-point data as a fi object — Create fixed-point numeric object

off (default) | on

Select **Log fixed-point data as a fi object** to create a fi object in the MATLAB workspace when the input signal has a fixed point data type. For more information on fi objects, see the fi Object Properties (Fixed-Point Designer).

Input port labels — Input port names

R|G|B (default)

Name the input ports using the vertical bar character as a delimiter.

Dependencies

To enable this parameter, set the **Number of inputs** parameter to a value greater than 1.

Block Characteristics

Data Types	Boolean double fixed point integer single
Multidimensional Signals	yes
Variable-Size Signals	no

See Also

Blocks

Image From Workspace | Video From Workspace | Write Binary File

Introduced before R2006a

Warp

Apply projective or affine transformation

Library: Computer Vision Toolbox / Geometric Transformations

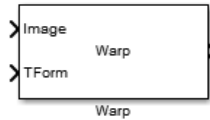

Description

The Warp block transforms an image by applying projective on page 1-387 or affine on page 1-387 transformation. You can transform the entire image or a region of the image by defining a rectangular region of interest (ROI).

Ports

Input

Image — Input image

matrix | 3-D numeric array

Input image, specified as one of these values:

- matrix — For intensity images of size M -by- N .
- 3-D numeric array — For true color images of size M -by- N -by-3.

Data Types: single | double | int8 | int16 | int32 | int64 | uint8 | uint16 | uint32 | uint64

TForm — Transformation matrix

3-by-2 matrix | 3-by-3 matrix

Transformation matrix, specified as any one of these values:

- 3-by-2 matrix — For affine transformation.
- 3-by-3 matrix — For projective transformation.

For more information about the transformations, see “Algorithms” on page 1-387.

Dependencies

To enable this input port, set the **Transformation matrix source** parameter value to Input port.

Data Types: double | single

ROI — Region of interest

4-element vector

Region of interest, specified as a 4-element vector of form $[x_s \ y_s \ width \ height]$. x_s and y_s are the x and y coordinates of the top left corner of the ROI, respectively.

If you specify the ROI input, the Warp block applies transformation only to the specified region and returns the transformed region at the output.

Dependencies

To enable this input port, select the **Enable ROI input port** parameter.

Output

Image — Transformed image

matrix | 3-D numeric array

Transformed image, returned as one of these values:

- matrix — If input is an intensity image of size P -by- $Q1$.
- 3-D numeric array — If input is a true color image of size P -by- Q -by-3.

The data type of the output transformed image is same as that of the input image. The size of the output transformed image is either same as the input image or equal to the value set for the **Output image position vector [x y width height]** parameter.

Data Types: single | double | int8 | int16 | int32 | int64 | uint8 | uint16 | uint32 | uint64

Err_roi — Indicator for transformed ROI outside image region

0 | 1

Indicator for transformed ROI outside image region, returned as 0 or 1.

Data Types: Boolean

Parameters

Transformation matrix for source — Source for passing transformation matrix

Input port (default) | Custom

Source for passing transformation matrix, specified as either `Input port` or `Custom`. If you select `Custom`, you can enter the transformation matrix coefficients by using the **Transformation matrix** parameter that appears with this selection.

Transformation matrix — Value for transformation matrix

3-by-2 matrix | 3-by-3 matrix

Value for transformation matrix, specified as a 3-by-2 matrix for affine transformation or 3-by-3 matrix for projective transformation.

Dependencies

To enable this parameter, set the **Transformation matrix for source** parameter value to `Custom`.

Interpolation method — Method for interpolating transformed pixel values

Bilinear (default) | Nearest neighbor | Bicubic

Method for interpolating transformed pixel values, specified as `Nearest neighbor`, `Bilinear`, or `Bicubic`.

If you select `Nearest neighbor`, the block uses the value of an nearby pixel for the new pixel value. If you select `Bilinear`, the new pixel value is the weighted average of the four nearest pixel values. If you select `Bicubic`, the new pixel value is the weighted average of the sixteen nearest pixel values.

The number of pixels the block considers affects the complexity of the computation. Therefore, the **Nearest neighbor** interpolation is the most computationally efficient. However, because the accuracy of the method is proportional to the number of pixels considered, the **Bicubic** method is the most accurate. For information about the interpolation methods, see the “More About” on page 1-384 section.

Background fill value — Intensity value for background pixels in the transformed image

0 (default) | scalar | 3-element vector

Intensity value for background pixels in the transformed image, specified as one of these values:

- scalar — If input image is a gray scale image.
- 3-element vector — If input image is a true color image. The vector is of the form $[r\ g\ b]$ specifying the red (r), green (g), and blue (b) color channel values for the background pixels.

The default fill value is 0 and sets the background color to black.

Output image position source — Source for passing output image size

Same as input image (default) | Custom

Source for passing a value for the output image size, specified as either **Same as input image** or **Custom**.

- If you select **Same as input image**, the output transformed image is of same size as that of the input image.
- If you select **Custom**, you must specify a bounding box to output only the image region that lies within the bounding box. This selection enables the **Output image position vector $[x\ y\ width\ height]$** parameter that you can use for specifying the bounding box value.

Output image position vector $[x\ y\ width\ height]$ — Size of the output image

[1 1 512 512] (default) | 4-element vector

Size of the output image, specified as a four element vector of form $[x\ y\ width\ height]$. When you specify this parameter, the **Warp** block creates a bounding box of specified width and height values. The size of the output image is set to the size of the bounding box and will contain the transformed image region that lies within the bounding box. If the size of the output image is greater than the size of the transformed image region within the bounding box, the intensity value of the extraneous pixels in the output image are set to the value specified for **Background fill value** parameter.

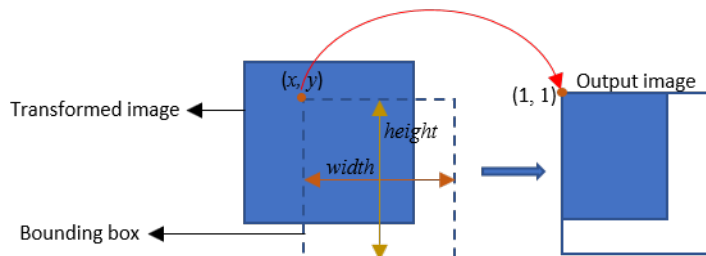

x and y are the spatial coordinates that define top-left corner position of the bounding box with respect to the input image.

Dependencies

To enable this parameter, set the **Output image position source** parameter value to **Custom**.

Enable ROI input port — Input ROI

off (default) | on

Select this parameter to enable the ROI input port and specify the ROI to be transformed.

Enable output port indicating if any part of ROI is outside input image — Output if transformed ROI is outside the specified image size

off (default) | on

Select this parameter to enable the Err_roi output port.

Dependencies

To enable this parameter, select the **Enable ROI input port** parameter.

Simulate using — Block simulation method

Interpreted Execution (default) | Code Generation

Block simulation method, specified as Interpreted Execution or Code Generation. If you want your block to use the MATLAB interpreter, choose Interpreted Execution. If you want your block to run as compiled code, choose Code Generation. For more information, see “Choosing a Simulation Mode” (Simulink).

Block Characteristics

Data Types	Boolean double fixed point integer single
Multidimensional Signals	yes
Variable-Size Signals	yes

More About**Nearest Neighbor Interpolation Method**

For nearest neighbor interpolation, the block uses the value of nearby translated pixel values for the output pixel values.

For example, suppose this matrix,

```
1 2 3
4 5 6
7 8 9
```

represents your input image. You want to translate this image 1.7 pixels in the positive horizontal direction using nearest neighbor interpolation. The block's nearest neighbor interpolation algorithm is illustrated by the following steps:

- 1 Zero pad the input matrix and translate it by 1.7 pixels to the right.

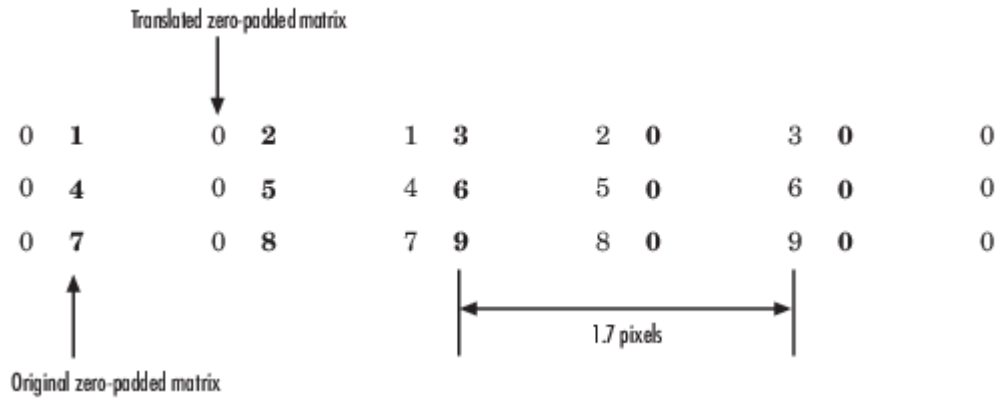

- 2 Create the output matrix by replacing each input pixel value with the translated value nearest to it. The result is the following matrix:

```
0 0 1 2 3
0 0 4 5 6
0 0 7 8 9
```

Note You wanted to translate the image by 1.7 pixels, but this method translated the image by 2 pixels. Nearest neighbor interpolation is computationally efficient but not as accurate as bilinear or bicubic interpolation methods.

Bilinear Interpolation

For bilinear interpolation, the block uses the weighted average of two translated pixel values for each output pixel value.

For example, suppose this matrix,

```
1 2 3
4 5 6
7 8 9
```

represents your input image. You want to translate this image 0.5 pixel in the positive horizontal direction using bilinear interpolation. The block's bilinear interpolation algorithm is illustrated by the following steps:

- 1 Zero pad the input matrix and translate it by 0.5 pixel to the right.

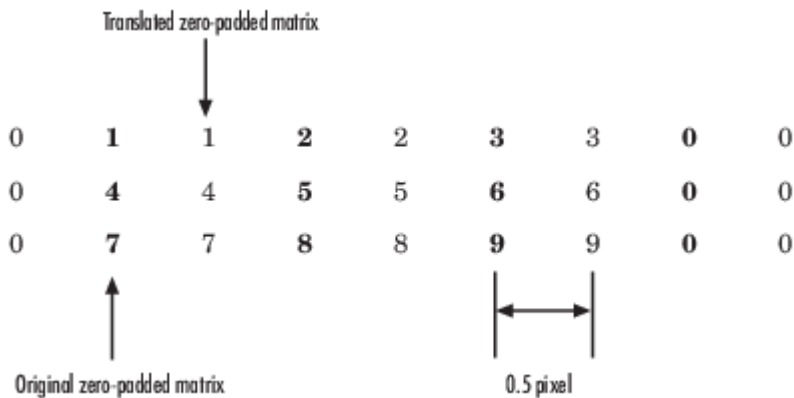

- 2 Create the output matrix by replacing each input pixel value with the weighted average of the translated values on either side. The result is the following matrix where the output matrix has one more column than the input matrix:

```
0.5 1.5 2.5 1.5
 2  4.5 5.5  3
3.5 7.5 8.5 4.5
```

Bicubic Interpolation

For bicubic interpolation, the block uses the weighted average of four translated pixel values for each output pixel value.

For example, suppose this matrix,

```
1 2 3
4 5 6
7 8 9
```

represents your input image. You want to translate this image 0.5 pixel in the positive horizontal direction using bicubic interpolation. The block's bicubic interpolation algorithm is illustrated by the following steps:

- 1 Zero pad the input matrix and translate it by 0.5 pixel to the right.

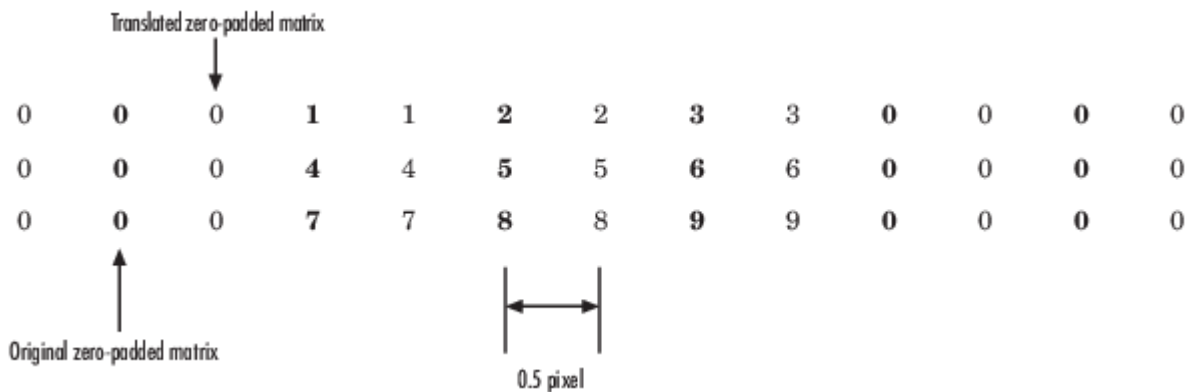

- 2 Create the output matrix by replacing each input pixel value with the weighted average of the two translated values on either side. The result is the following matrix where the output matrix has one more column than the input matrix:

```
0.375  1.5   3   1.625
1.875  4.875 6.375 3.125
3.375  8.25  9.75 4.625
```

Algorithms

Affine Transformation

The affine transformation matrix is a 3-by-2 matrix of form

$$H = \begin{bmatrix} h_1 & h_4 \\ h_2 & h_5 \\ h_3 & h_6 \end{bmatrix}$$

where h_1, h_2, \dots, h_6 are transformation coefficients.

The value of the pixel located at $[x, y]$ in the input image determines the value of the pixel located at $[\hat{x}, \hat{y}]$ in the output transformed image. The relationship between the input and output point locations is defined by:

$$\begin{cases} \hat{x} = xh_1 + yh_2 + h_3 \\ \hat{y} = xh_4 + yh_5 + h_6 \end{cases}$$

Projective Transformation

The projective transformation matrix is a 3-by-3 matrix of form

$$H = \begin{bmatrix} h_1 & h_4 & h_7 \\ h_2 & h_5 & h_8 \\ h_3 & h_6 & h_9 \end{bmatrix}$$

where h_1, h_2, \dots, h_9 are transformation coefficients.

The value of the pixel located at $[x, y]$ in the input image determines the value of the pixel located at $[\hat{x}, \hat{y}]$ in the output transformed image.

The relationship between the input and output point locations is defined by:

$$\begin{cases} \hat{x} = \frac{xh_1 + yh_2 + h_3}{xh_7 + yh_8 + h_9} \\ \hat{y} = \frac{xh_4 + yh_5 + h_6}{xh_7 + yh_8 + h_9} \end{cases}$$

The values of pixels in the output point locations are calculated using any of these interpolation methods: Nearest neighbor, bilinear, and bicubic interpolation.

Extended Capabilities

C/C++ Code Generation

Generate C and C++ code using Simulink® Coder™.

See Also

Functions

imwarp

Blocks

Estimate Geometric Transformation | Resize | Rotate | Shear | Translate

Introduced in R2015b

ToOpenCV

Converts Simulink data types to OpenCV data types

Library: Computer Vision Toolbox Interface for OpenCV in Simulink

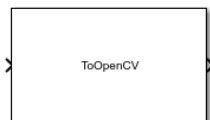

Description

The ToOpenCV block converts the Simulink data types to Simulink OpenCV data types.

Ports

Inputs

Port_1 — Input signal

scalar | vector | matrix | simulink bus | simulink image

Input signal to the ToOpenCV block. The input can be of different data types. Each of the input data types determines the output data type of the block.

Data Types: uint8 | uint16 | int8 | int16 | int32 | single | double | Simulink.ImageType | CV_DMATCH_BUS | CV_RECT_BUS | CV_ROTATEDRECT_BUS | CV_TERMCRITERIA_BUS | CV_SIZE_BUS | CV_RANGE_BUS | CV_POINT2I_BUS | CV_POINT2F_BUS | CV_POIINT2D_BUS | CV_POIINT3I_BUS | CV_POIINT3F_BUS | CV_POIINT3D_BUS

Output

Port_1 — Output signal

scalar | vector | matrix | simulink bus | simulink image

Output signal from the ToOpenCV block. The output signal supports OpenCV types. For more information, see Mapping Input and Output Data Types on page 1-390.

Data Types: OpenCV types

Parameters

Data Type — Data type of the Input signal of ToOpenCV block

input data type (default)

Specifies the input data type of the ToOpenCV block. The table on page 1-390 lists the one-to-one mapping of the input versus output data types of the ToOpenCV block.

Programmatic Use

Block Parameter: DataType

Type: character vector

Value: input data type

Default: 'Point2i'

Block Characteristics

Data Types	
Direct Feedthrough	Yes
Multidimensional Signals	Yes
Variable-Size Signals	No

More About

Mapping of Input and Output Data Types

The table lists the one-to-one mapping of the input versus output data types of the ToOpenCV block.

Data Type Parameter	ToOpenCV Block Output Signal Data Type	ToOpenCV Block Input Signal Data Type
Mat or Mat-Image	cv_Mat	uint8 array
		uint16 array
		int8 array
		int16 array
		int32 array
		single array
		double array
		Simulink.ImageType
Simulink.ImageType	cv_Mat	Simulink.ImageType
DMatch	cv_DMatch	CV_DMATCH_BUS
vector<DMatch>	vector_cv_DMatch	CV_DMATCH_BUS (1d array)
vector<vector<DMatch>>	vector_vector_cv_DMatch	CV_DMATCH_BUS (2d array)
Rect	cv_Rect	CV_RECT_BUS
vector<Rect>	vector_cv_Rect	CV_RECT_BUS (1d array)
RotatedRect	cv_RotatedRect	CV_ROTATEDRECT_BUS
vector<RotatedRect>	vector_cv_RotatedRect	CV_ROTATEDRECT_BUS (1d array)
TermCriteria	cv_TermCriteria	CV_TERMCRITERIA_BUS
Scalar	cv_Scalar	double array
Size	cv_Size	CV_SIZE_BUS
Range	cv_Range	CV_RANGE_BUS
Point	cv_Point	CV_POINT2I_BUS
Point2f	cv_Point2f	CV_POINT2F_BUS
Point2d	cv_Point2d	CV_POINT2D_BUS
Point3i	cv_Point3i	CV_POINT3I_BUS

Data Type Parameter	ToOpenCV Block Output Signal Data Type	ToOpenCV Block Input Signal Data Type
Point3f	cv_Point3f	CV_POINT3F_BUS
Point3d	cv_Point3d	CV_POINT3D_BUS
vector<Point>	vector_cv_Point	CV_POINT2I_BUS (1d array)
vector<Point2f>	vector_cv_Point2f	CV_POINT2F_BUS (1d array)
vector<Point2d>	vector_cv_Point2d	CV_POINT2D_BUS (1d array)
vector<Point3i>	vector_cv_Point3i	CV_POINT3I_BUS (1d array)
vector<Point3f>	vector_cv_Point3f	CV_POINT3F_BUS (1d array)
vector<Point3d>	vector_cv_Point3d	CV_POINT3D_BUS (1d array)
vector<vector<Point>>	vector_vector_cv_Point	CV_POINT2I_BUS (2d array)
vector<vector<Point2f>>	vector_vector_cv_Point2f	CV_POINT2F_BUS (2d array)
vector<vector<Point2d>>	vector_vector_cv_Point2d	CV_POINT2D_BUS (2d array)
vector<vector<Point3i>>	vector_vector_cv_Point3i	CV_POINT3I_BUS (2d array)
vector<vector<Point3f>>	vector_vector_cv_Point3f	CV_POINT3F_BUS (2d array)
vector<vector<Point3d>>	vector_vector_cv_Point3d	CV_POINT3D_BUS (2d array)

Extended Capabilities

C/C++ Code Generation

Generate C and C++ code using Simulink® Coder™.

Supports C++ code generation.

See Also

FromOpenCV | Matrix To Image | Image To Matrix

Topics

“Install and Use Computer Vision Toolbox Interface for OpenCV in Simulink”

Introduced in R2020a

FromOpenCV

Converts OpenCV data types to Simulink data types

Library: Computer Vision Toolbox Interface for OpenCV in Simulink



Description

The FromOpenCV block converts the Simulink OpenCV data types to Simulink data types.

Ports

Inputs

Port_1 — First input signal

scalar | vector | matrix | simulink bus | simulink image

Input signal to the FromOpenCV block. The input can be of different data types. Each of the input data types determines the output data type of the block. For more information, see Mapping Input and Output Data Types. on page 1-393

Data Types: OpenCV types

Output

Port_1 — Output signal

scalar | vector | matrix | simulink bus | simulink image

Output signal from the FromOpenCV block.

Data Types: Converted Simulink types

Parameters

Data Type — Data type of the Input signal of FromOpenCV block

input data type (default)

Specifies the input data type of the FromOpenCV block. The table on page 1-393 lists the one-to-one mapping of the input versus output data types of the FromOpenCV block.

Programmatic Use

Block Parameter: DataType

Type: character vector

Value: input data type

Default: 'Point2i'

Block Characteristics

Data Types	
Direct Feedthrough	Yes
Multidimensional Signals	Yes
Variable-Size Signals	No

More About

Mapping of Input and Output Data Types

The table lists the one-to-one mapping of the input versus output data types of the FromOpenCV block.

Data Type Parameter	FromOpenCV Block Input Signal Data Type	FromOpenCV Block Output Signal Data Type
Mat or Mat-Image	cv_Mat	uint8 array
		uint16 array
		int8 array
		int16 array
		int32 array
		single array
		double array
Simulink.ImageType	cv_Mat	Simulink.ImageType
DMatch	cv_DMatch	CV_DMATCH_BUS
vector<DMatch>	vector_cv_DMatch	CV_DMATCH_BUS (1d array)
vector<vector<DMatch>>	vector_vector_cv_DMatch	CV_DMATCH_BUS (2d array)
Rect	cv_Rect	CV_RECT_BUS
vector<Rect>	vector_cv_Rect	CV_RECT_BUS (1d array)
RotatedRect	cv_RotatedRect	CV_ROTATEDRECT_BUS
vector<RotatedRect>	vector_cv_RotatedRect	CV_ROTATEDRECT_BUS (1d array)
TermCriteria	cv_TermCriteria	CV_TERMCRITERIA_BUS
Scalar	cv_Scalar	double array
Size	cv_Size	CV_SIZE_BUS
Range	cv_Range	CV_RANGE_BUS
Point	cv_Point	CV_POINT2I_BUS
Point2f	cv_Point2f	CV_POINT2F_BUS
Point2d	cv_Point2d	CV_POINT2D_BUS

Data Type Parameter	FromOpenCV Block Input Signal Data Type	FromOpenCV Block Output Signal Data Type
Point3i	cv_Point3i	CV_POINT3I_BUS
Point3f	cv_Point3f	CV_POINT3F_BUS
Point3d	cv_Point3d	CV_POINT3D_BUS
vector<Point>	vector_cv_Point	CV_POINT2I_BUS (1d array)
vector<Point2f>	vector_cv_Point2f	CV_POINT2F_BUS (1d array)
vector<Point2d>	vector_cv_Point2d	CV_POINT2D_BUS (1d array)
vector<Point3i>	vector_cv_Point3i	CV_POINT3I_BUS (1d array)
vector<Point3f>	vector_cv_Point3f	CV_POINT3F_BUS (1d array)
vector<Point3d>	vector_cv_Point3d	CV_POINT3D_BUS (1d array)
vector<vector<Point>>	vector_vector_cv_Point	CV_POINT2I_BUS (2d array)
vector<vector<Point2f>>	vector_vector_cv_Point2f	CV_POINT2F_BUS (2d array)
vector<vector<Point2d>>	vector_vector_cv_Point2d	CV_POINT2D_BUS (2d array)
vector<vector<Point3i>>	vector_vector_cv_Point3i	CV_POINT3I_BUS (2d array)
vector<vector<Point3f>>	vector_vector_cv_Point3f	CV_POINT3F_BUS (2d array)
vector<vector<Point3d>>	vector_vector_cv_Point3d	CV_POINT3D_BUS (2d array)

Extended Capabilities

C/C++ Code Generation

Generate C and C++ code using Simulink® Coder™.

Supports C++ code generation.

See Also

ToOpenCV | Matrix To Image | Image To Matrix

Topics

“Install and Use Computer Vision Toolbox Interface for OpenCV in Simulink”

Introduced in R2020a

Objects

inflated3dVideoClassifier

Inflated-3D (I3D) video classifier. Requires Computer Vision Toolbox Model for Inflated-3D Video Classification

Description

The `inflated3dVideoClassifier` object is an Inflated-3D (I3D) video classifier pretrained on the Kinetics-400 data set. You can use the pretrained video classifier to classify 400 human actions, such as running, walking, and shaking hands. The I3D classifier model contains two subnetworks: the video network and the optical flow network. Both of these networks are trained on Kinetics-400 with RGB data and optical flow data respectively.

Creation

Syntax

```
i3d = inflated3dVideoClassifier
i3d = inflated3dVideoClassifier(classifierName,classes)
i3d = inflated3dVideoClassifier( ___,Name=Value)
```

Description

`i3d = inflated3dVideoClassifier` returns the I3D video classifier pretrained on the Kinetics-400 dataset.

`i3d = inflated3dVideoClassifier(classifierName,classes)` configures the pretrained Inflated 3D (I3D) video classifier for transfer learning on a new set of classes, `classes`, using one of two pretrained classifiers, specified by `classifierName`.

`i3d = inflated3dVideoClassifier(___,Name=Value)` sets properties using name-value arguments in addition to the input arguments from the previous syntax. For example, `i3d = inflated3dVideoClassifier("googlenet-video","wavingHello","clapping",InputSize=[224,224,3,64])` sets the input size of the network to 64 frames of 224-by-224 pixels with 3 channels. You can specify multiple name-value arguments.

Note This object requires the Computer Vision Toolbox Model for Inflated-3D Video Classification. You can install the Computer Vision Toolbox Model for Inflated-3D Video Classification from Add-On Explorer. For more information about installing add-ons, see [Get and Manage Add-Ons](#). To use this object, you must have a license for the Deep Learning Toolbox™.

Input Arguments

`classifierName` — Classifier name

"googlenet-video" | "googlenet-video-flow"

Classifier name, specified as "googlenet-video" or "googlenet-video-flow".

Classifier	Description
"googlenet-video"	GoogLeNet-based I3D model pretrained on the Kinetics-400 video data for transfer learning.
"googlenet-video-flow"	GoogLeNet-based I3D model pretrained on the Kinetics-400 video and optical flow data for transfer learning. During training and inference, both video and optical flow data are used for classification.

Properties

Configure Classifier Properties

InputSize — Size of network

[224, 224, 3, 64] (default) | four-element row vector

This property is read-only.

Size of the video classifier network, specified as a four-element row vector in the form $[H, W, C, T]$, where H and W represent the height and width respectively, C represents the number of channels, and T represents the number of frames for the video subnetwork.

The input size of the flow subnetwork is equal in height, width, and number of frames, but the number of channels is fixed to 2.

Typical values for the number of frames are 8, 16, 32, or 64. Increase the number of frames to capture the temporal nature of activities when training the classifier. When you are using optical flow data, the number of channels must equal 2, which correspond to the x - and y -components of velocity.

InputNormalizationStatistics — Normalization statistics for the video and optical flow data

(default) | structure

This property is read-only.

Normalization statistics for the video and optical flow data, specified as a structure with field names `Video` and `OpticalFlow`, which are also structures with field names `Min`, `Max`, `Mean`, and `StandardDeviation`. The `Min` and `Max` field values define the minimum and maximum values for rescaling the video and optical flow data. The `Mean`, and `StandardDeviation` values define the mean and standard deviation for input normalization. All field values must be specified as a row vector of size equal to the number of channels for the video input data. When you are using optical flow data, the number of channels must equal 2, which correspond to the x - and y components of velocity.

The default structure contains:

- A `Video` field, which contains the field `Min` set to $[0, 0, 0]$, and the field `Max` set to $[255, 255, 255]$.
- Empty `OpticalFlow`, `Mean`, and `StandardDeviation` field values.

For a video input, the data is rescaled between -1 and 1 using the `Min` and `Max` field values. For an optical flow input, the data is rescaled between -1 and 1 using computed minimum and maximum values from the input data.

Note When the `Min` and `Max` field values are not empty, the object first rescales the input data between -1 and 1. Then, if the `Mean`, and `StandardDeviation` field values are not empty, the object normalizes the rescaled values by subtracting the mean and dividing by the standard deviation.

An example using this property:

```
stats.Video = struct(Min=[0,0,0],Max=[255,255,255], ...
Mean=[],StandardDeviation=[]);
stats.OpticalFlow = struct(Min=[-20,-20],Max=[20,20] ,...
Mean=[],StandardDeviation=[]);
i3d = inflated3dVideoClassifier('googlenet-video-flow',["waving","clapping"],InputNormalizationS
```

ModelName — Name of trained video classifier

string scalar

Name of the trained video classifier, specified as a string scalar.

Classes — Classes that the video classifier is configured to train or classify

vector of strings | cell array of character vectors

This property is read-only.

Classes that the video classifier is configured to train or classify, specified as a vector of strings or a cell array of character vectors. For example:

```
classes = ['kiss','laugh','pick','pour','pushup'];
```

Training Properties

VideoLearnables — Learnable parameters for video subnetwork of I3D video classifier

table with three columns

Learnable parameters for the video subnetwork of the I3D video classifier, specified as a table with three columns.

- `Layer` — Layer name, specified as a string scalar.
- `Parameter` — Parameter name, specified as a string scalar.
- `Value` — Parameter value, specified as a `darray` object.

The network learnable parameters contain the features learned by the network. For example, the weights of convolution and fully connected layers.

VideoState — State of the nonlearnable parameters for the video subnetwork of the I3D video classifier

table with three columns

State of the nonlearnable parameters for the video subnetwork of the I3D video classifier, specified as a table with three columns.

- `Layer` — Layer name, specified as a string scalar.
- `Parameter` — Parameter name, specified as a string scalar.
- `Value` — Parameter value, specified as a `dlarray` object.

The network state contains information remembered by the network between iterations. For example, the state of LSTM and batch normalization layers. During training or inference, you can update the network state using the output of the `forward` and `predict` functions.

OpticalLearnables — Learnable parameters for the optical flow subnetwork of the I3D video classifier

table with three columns

Learnable parameters for the optical flow subnetwork of the I3D video classifier, specified as a table with three columns. Network learnable parameters, specified as a table with three columns:

- `Layer` — Layer name, specified as a string scalar.
- `Parameter` — Parameter name, specified as a string scalar.
- `Value` — Parameter value, specified as a `dlarray` object.

The network learnable parameters contain the features learned by the network. For example, the weights of convolution and fully connected layers.

OpticalFlowState — State of the nonlearnable parameters for the optical flow subnetwork of the I3D video classifier

table with three columns

State of the nonlearnable parameters for the video subnetwork of the I3D video classifier, specified as a table with three columns. Network learnable parameters, specified as a table with three columns:

- `Layer` — Layer name, specified as a string scalar.
- `Parameter` — Parameter name, specified as a string scalar.
- `Value` — Parameter value, specified as a `dlarray` object.

The network learnable parameters contain the features learned by the network. For example, the weights of convolution and fully connected layers.

Streaming Video Classification Properties

VideoSequence — Video sequence used for streaming classification

4-D numeric array

This property is read-only.

Video sequence used to update and classify sequences for for streaming classification, specified as a 4-D numeric array. Each vector in the array is of the form $[H,W,C,T]$, where H and W represent the height and width respectively, C represents the number of channels, and T represents the number of frames, for the video subnetwork. The `updateSequence` and `classifySequence` object functions use the video sequence specified by the `VideoSequence` property.

OpticalFlowSequence — Optical flow sequence used for streaming classification

4-D numeric array

This property is read-only.

Optical flow sequence used to update and classify sequences for streaming classification, specified as a 4-D numeric array. Each vector in the array is of the form (H,W,C,T) , where H and W represent the height and width respectively, C represents the number of channels, and T represents the number of frames, for the optical flow subnetwork. The `updateSequence` and `classifySequence` object functions use the optical flow sequence specified by the `OpticalFlowSequence`.

Object Functions

Video Classification

<code>classifyVideoFile</code>	Classify a video file
<code>resetSequence</code>	Reset video and optical flow sequence properties for streaming video classification
<code>updateSequence</code>	Update video or optical flow sequence for classification
<code>classifySequence</code>	Classify video and optical flow sequence

Custom Training and Inference

<code>forward</code>	Compute video classifier outputs for training
<code>predict</code>	Compute video classifier predictions

Examples

Classify Video File Using Inflated 3D Video Classifier

This example shows how to use `classifyVideoFile` to classify a video using an Inflated 3D video classifier.

Load a pretrained Inflated-3D video network.

```
i3d = inflated3dVideoClassifier();
```

Specify the video file name to classify.

```
videoFilename = 'visiontraffic.avi';
```

Classify the video using the video classifier.

```
label = classifyVideoFile(i3d, videoFilename);
```

Note that the classifier is not fine-tuned to compute the correct predictions for `visiontraffic.avi`, therefore, the predicted label will not be correct. You must train the classifier for optimal performance on your video data.

See Also

Apps

Video Labeler

Functions

`sceneTimeRanges` | `writeVideoScenes`

Objects

dlnetwork | r2plus1dVideoClassifier | slowFastVideoClassifier

Topics

“Getting Started with Video Classification Using Deep Learning”

“Evaluate a Video Classifier”

“Classify Streaming Webcam Video Using SlowFast Video Classifier”

“Activity Recognition from Video and Optical Flow Data Using Deep Learning”

Introduced in R2021b

slowFastVideoClassifier

SlowFast video classifier. Requires Computer Vision Toolbox Model for SlowFast Video Classification

Description

The `slowFastVideoClassifier` object is a SlowFast video classifier pretrained on the Kinetics-400 data set with a ResNet-50 3-D convolutional neural network (CNN). You can use the pretrained video classifier to classify 400 human actions such as running, walking, and shaking hands.

Creation

Syntax

```
sf = slowFastVideoClassifier
sf = slowFastVideoClassifier("resnet50-3d",classes)
sf = slowFastVideoClassifier( ____,Name=Value)
```

Description

`sf = slowFastVideoClassifier` returns a SlowFast video classifier pretrained on the Kinetics-400 data set.

`sf = slowFastVideoClassifier("resnet50-3d",classes)` configures the pretrained SlowFast video classifier for transfer learning on a new set of classes, `classes`.

`sf = slowFastVideoClassifier(____,Name=Value)` sets properties using name-value arguments in addition to the input arguments from the previous syntax. For example, `sf = slowFastVideoClassifier("resnet50-3d",classes,InputSize=[256,256,3,32])` sets the input size of the network. You can specify multiple name-value arguments.

Note This function requires the Computer Vision Toolbox Model for SlowFast Video Classification. You can install Computer Vision Toolbox Model for SlowFast Video Classification from Add-On Explorer. For more information about installing add-ons, see [Get and Manage Add-Ons](#). To use this object, you must have a license for the Deep Learning Toolbox.

Properties

Configure Classifier Properties

InputSize — Size of the network

[256,256,3,32] (default) | four-element row vector

This property is read-only.

Size of the video classifier network, specified as a four-element row vector in the form $[H,W,C,T]$, where H and W represent the height and width respectively, C represents the number of channels, and T represents the number of frames for the video subnetwork.

Typical values for the number of frames are 8, 16, 32, or 64. Increase the number of frames to capture the temporal nature of activities when training the classifier.

InputNormalizationStatistics — Normalization statistics for the video data

structure (default)

This property is read-only.

Normalization statistics for the video data, specified as a structure with field names `Min`, `Max`, `Mean`, and `StandardDeviation`. The `Min` and `Max` field values define the minimum and maximum values for rescaling the video data. The `Mean`, and `StandardDeviation` values define the mean and standard deviation for input normalization. All field values must be specified as a row vector of size equal to the number of channels for the video input data.

The default structure contains the fields, `Min`, `Max`, `Mean` and `StandardDeviation` with values $[0,0,0]$, $[255,255,255]$, $[0.45,0.45,0.45]$, and $[0.225,0.225,0.225]$, respectively. You must calculate the statistics values from the dataset for which you are training the video classifier. To rescale the data using minimum and maximum values precomputed from your dataset, specify both `Min` and `Max`. Otherwise, the minimum and maximum values are calculated from each input sequence when using `updateSequence` or `classifyVideoFile`.

Note The object normalizes the data by rescaling it between 0 and 1, and then the rescaled data is standardized by subtracting the mean and dividing by the standard deviation. The rescaled data is standardized if the `Mean` and `StandardDeviation` fields are non-empty. The input is automatically normalized when using `updateSequence` or `classifyVideoFile` object functions. The data must be manually normalized when using the `forward` or `predict` object functions.

ModelName — Name of trained video classifier

string scalar

Name of the trained video classifier, specified as a string scalar.

Classes — Classes that the video classifier is configured to train or classify

vector of strings | cell array of character vectors

This property is read-only.

Classes that the video classifier is configured to train or classify, specified as a vector of strings or a cell array of character vectors. For example:

```
classes = ['kiss', 'laugh', 'pick', 'pour', 'pushup'];
```

Training Properties

Learnables — Learnable parameters for the SlowFast video classifier

table with three columns

Learnable parameters for the SlowFast video classifier, specified as a table with three columns.

- `Layer` — Layer name, specified as a string scalar.
- `Parameter` — Parameter name, specified as a string scalar.
- `Value` — Parameter value, specified as a `dlarray` object.

The network state contains information remembered by the network between iterations. For example, the state of long short term networks (LSTM) and batch normalization layers. During training or inference, you can update the network state using the output of the `forward` and `predict` object functions.

State — State of the nonlearnable parameters of the SlowFast video classifier

table with three columns

State of the nonlearnable parameters of the SlowFast video classifier, specified as a table with three columns.

- `Layer` — Layer name, specified as a string scalar.
- `Parameter` — Parameter name, specified as a string scalar.
- `Value` — Parameter value, specified as a `dlarray` object.

The network learnable parameters contain the features learned by the network. For example, the weights of convolution and fully connected layers.

Streaming Video Classification Properties

VideoSequence — Video sequence used for streaming classification

4-D numeric array

This property is read-only.

Video sequence used to update and classify sequences for for streaming classification, specified as a 4-D numeric array. Each vector in the array is of the form $[H,W,C,T]$, where H and W represent the height and width respectively, C represents the number of channels, and T represents the number of frames, for the video subnetwork. The `updateSequence` and `classifySequence` object functions use the video sequence specified by the `VideoSequence` property.

Object Functions

Video Classification

<code>classifyVideoFile</code>	Classify a video file
<code>classifySequence</code>	Classify video sequence
<code>resetSequence</code>	Reset video sequence properties for streaming video classification
<code>updateSequence</code>	Update video sequence for classification

Custom Training and Inference

<code>forward</code>	Compute video classifier outputs for training
<code>predict</code>	Compute video classifier predictions

Examples

Classify Video File Using Video Classifier

Load a slowfast video classifier pretrained on the Kinetics-400 data set.

```
sf = slowFastVideoClassifier;
```

Specify the file name of the video to classify.

```
videoFilename = "washingHands.avi";
```

For video classification, set the number of randomly selected video sequences to 15.

```
numSequences = 15;
```

Classify the video using the `classifyVideoFile` function.

```
[label,score] = classifyVideoFile(sf,videoFilename,NumSequences=numSequences)
```

```
label = categorical  
      washing hands
```

```
score = single  
      0.0034
```

Display the classified label using a `vision.VideoPlayer`.

```
player = vision.VideoPlayer('Name','Washing Hands');  
reader = VideoReader(videoFilename);  
while hasFrame(reader)  
    frame = readFrame(reader);  
    % Resize the frame by 1.5 times for display  
    frame = imresize(frame,1.5);  
    frame = insertText(frame,[2,2], string(label),'FontSize',18);  
    step(player,frame);  
end
```

Washing Hands

File Tools View Playback Help

+ - Hand [Zoom]



Processing Magnification: 100% RGB:405x720 224

See Also

Apps
Video Labeler

Functions
sceneTimeRanges | writeVideoScenes

Objects
dlnetwork | inflated3dVideoClassifier | r2plus1dVideoClassifier

Topics

“Getting Started with Video Classification Using Deep Learning”

“Evaluate a Video Classifier”

“Classify Streaming Webcam Video Using SlowFast Video Classifier”

“Gesture Recognition using Videos and Deep Learning”

Introduced in R2021b

r2plus1dVideoClassifier

R(2+1)D video classifier. Requires Computer Vision Toolbox Model for R(2+1)D Video Classification

Description

The `r2plus1dVideoClassifier` object returns an R(2+1)D video classifier pretrained on the Kinetics-400 data set. You can use the pretrained video classifier to classify 400 human actions, such as running, walking, and shaking hands.

Creation

Syntax

```
rd = r2plus1dVideoClassifier
rd = r2plus1dVideoClassifier("resnet-3d-18",classes)
rd = r2plus1dVideoClassifier(___,Name=Value)
```

Description

`rd = r2plus1dVideoClassifier` returns a R(2+1)D video classifier pretrained on the Kinetics-400 dataset.

`rd = r2plus1dVideoClassifier("resnet-3d-18",classes)` configures the pretrained R(2+1)D video classifier for transfer learning on a new set of classes, `classes`. The video classifier is pretrained on the Kinetics-400 dataset with a ResNet3D convolutional neural network(CNN) with 18 spatio-temporal layers.

`rd = r2plus1dVideoClassifier(___,Name=Value)` sets properties using name-value arguments in addition to the input arguments from the previous syntax. For example, `rd = r2plus1dVideoClassifier("resnet-3d-18",classes,InputSize=[112,112,3,32])` sets the input size of the network. You can specify multiple name-value arguments.

Note This function requires the Computer Vision Toolbox Model for R(2+1)D Video Classification. You can install the Computer Vision Toolbox Model for R(2+1)D Video Classification from Add-On Explorer. For more information about installing add-ons, see [Get and Manage Add-Ons](#). To use this object, you must have a license for the Deep Learning Toolbox.

Properties

Configure Classifier Properties

InputSize — Size of the network

[112, 112, 3, 32] (default) | four-element row vector

This property is read-only.

Size of the video classifier network, specified as a four-element row vector in the form $[H,W,C,T]$, where H and W represent the height and width respectively, C represents the number of channels, and T represents the number of frames for the video subnetwork.

Typical values for the number of frames are 8, 16, 32, or 64. Increase the number of frames to capture the temporal nature of activities when training the classifier.

InputNormalizationStatistics — Normalization statistics for the video data

structure (default)

This property is read-only.

Normalization statistics for the video data, specified as a structure with field names `Min`, `Max`, `Mean`, and `StandardDeviation`. The `Min` and `Max` field values define the minimum and maximum values for rescaling the video data. The `Mean`, and `StandardDeviation` values define the mean and standard deviation for input normalization. All field values must be specified as a row vector of size equal to the number of channels for the video input data.

The default structure contains the fields, `Min`, `Max`, `Mean` and `StandardDeviation` with values $[0,0,0]$, $[255,255,255]$, $[0.45,0.45,0.45]$, and $[0.225,0.225,0.225]$, respectively. You must calculate the statistics values from the dataset for which you are training the video classifier. To rescale the data using minimum and maximum values precomputed from your dataset, specify both `Min` and `Max`. Otherwise, the minimum and maximum values are calculated from each input sequence when using `updateSequence` or `classifyVideoFile`.

Note The object normalizes the data by rescaling it between 0 and 1, and then the rescaled data is standardized by subtracting the mean and dividing by the standard deviation. The rescaled data is standardized if the `Mean` and `StandardDeviation` fields are non-empty. The input is automatically normalized when using `updateSequence` or `classifyVideoFile` object functions. The data must be manually normalized when using the `forward` or `predict` object functions.

ModelName — Name of trained video classifier

string scalar

Name of the trained video classifier, specified as a string scalar.

Classes — Classes that the video classifier is configured to train or classify

vector of strings | cell array of character vectors

This property is read-only.

Classes that the video classifier is configured to train or classify, specified as a vector of strings or a cell array of character vectors. For example:

```
classes = ['kiss', 'laugh', 'pick', 'pour', 'pushup'];
```

Training Properties

Learnables — Learnable parameters for the ResNet (2+1)D video classifier

table with three columns

Learnable parameters for the ResNet (2+1)D video classifier, specified as a table with three columns.

- `Layer` — Layer name, specified as a string scalar.
- `Parameter` — Parameter name, specified as a string scalar.
- `Value` — Parameter value, specified as a `dlarray` object.

The network learnable parameters contain the features learned by the network. For example, the weights of convolution and fully connected layers.

State — State of the nonlearnable parameters of the R(2+1)D video classifier

table with three columns

State of the nonlearnable parameters for the ResNet (2+1)D video classifier, specified as a table with three columns.

- `Layer` — Layer name, specified as a string scalar.
- `Parameter` — Parameter name, specified as a string scalar.
- `Value` — Parameter value, specified as a `dlarray` object.

The network state contains information remembered by the network between iterations. For example, the state of long short term networks (LSTM) and batch normalization layers. During training or inference, you can update the network state using the output of the `forward` and `predict` object functions.

Streaming Video Classification Properties

VideoSequence — Video sequence used for streaming classification

4-D numeric array

This property is read-only.

Video sequence used to update and classify sequences for streaming classification, specified as a 4-D numeric array. Each vector in the array is of the form $[H,W,C,T]$, where H and W represent the height and width respectively, C represents the number of channels, and T represents the number of frames, for the video subnetwork. The `updateSequence` and `classifySequence` object functions use the video sequence specified by the `VideoSequence` property.

Object Functions

Video Classification

<code>classifyVideoFile</code>	Classify a video file
<code>classifySequence</code>	Classify video sequence
<code>resetSequence</code>	Reset video sequence properties for streaming video classification
<code>updateSequence</code>	Update video sequence for classification

Custom Training and Inference

<code>forward</code>	Compute video classifier outputs for training
<code>predict</code>	Compute video classifier predictions

Examples

Classify Video Stream Using R(2+1)D Video Classifier

This example shows how to classify a video stream using a pretrained R(2+1)D video classifier.

Load a pretrained R(2+1)D video classifier.

```
rd = r2plus1dVideoClassifier();
```

Create a VideoReader to read a video frame by frame.

```
videoFilename = "visiontraffic.avi";
reader = VideoReader(videoFilename);
```

Create a video player to visualize the video data and update the player position to match the size of the video.

```
player = vision.VideoPlayer;
player.Position(:,3:4) = [reader.Width reader.Height];
```

Specify the frequency at which the streaming video frames will be classified as 10. The classifier will be applied to a sequence of video frames every 10 frames to balance runtime performance against classification performance.

```
classificationFrequency = 10;
```

Specify the sequence length required by the classifier. This is based on the input size of the video classifier. You can begin to classify the sequence only after the sequence length reaches the required length.

```
sequenceLength = rd.InputSize(4);
```

Read through the video frame by frame, update the sequence with each new frame using `updateSequence`, and then classify the collected frames using `classifySequence`.

```
numFrames = 0;
text = "";

while hasFrame(reader)
    frame = readFrame(reader);
    numFrames = numFrames + 1;

    % Update the sequence with the next video frame.
    rd = updateSequence(rd, frame);

    % Classify the sequence based on the classificationFrequency.
    if mod(numFrames, classificationFrequency) == 0 && numFrames >= sequenceLength
        [label, score] = classifySequence(rd);
        text = string(label) + " " + num2str(score, "%0.2f");
    end

    % Insert the predicted label into the video frame.
    frame = insertText(frame, [30, 30], text, 'FontSize', 18);

    % Display the video and label.
    step(player, frame);
end
```

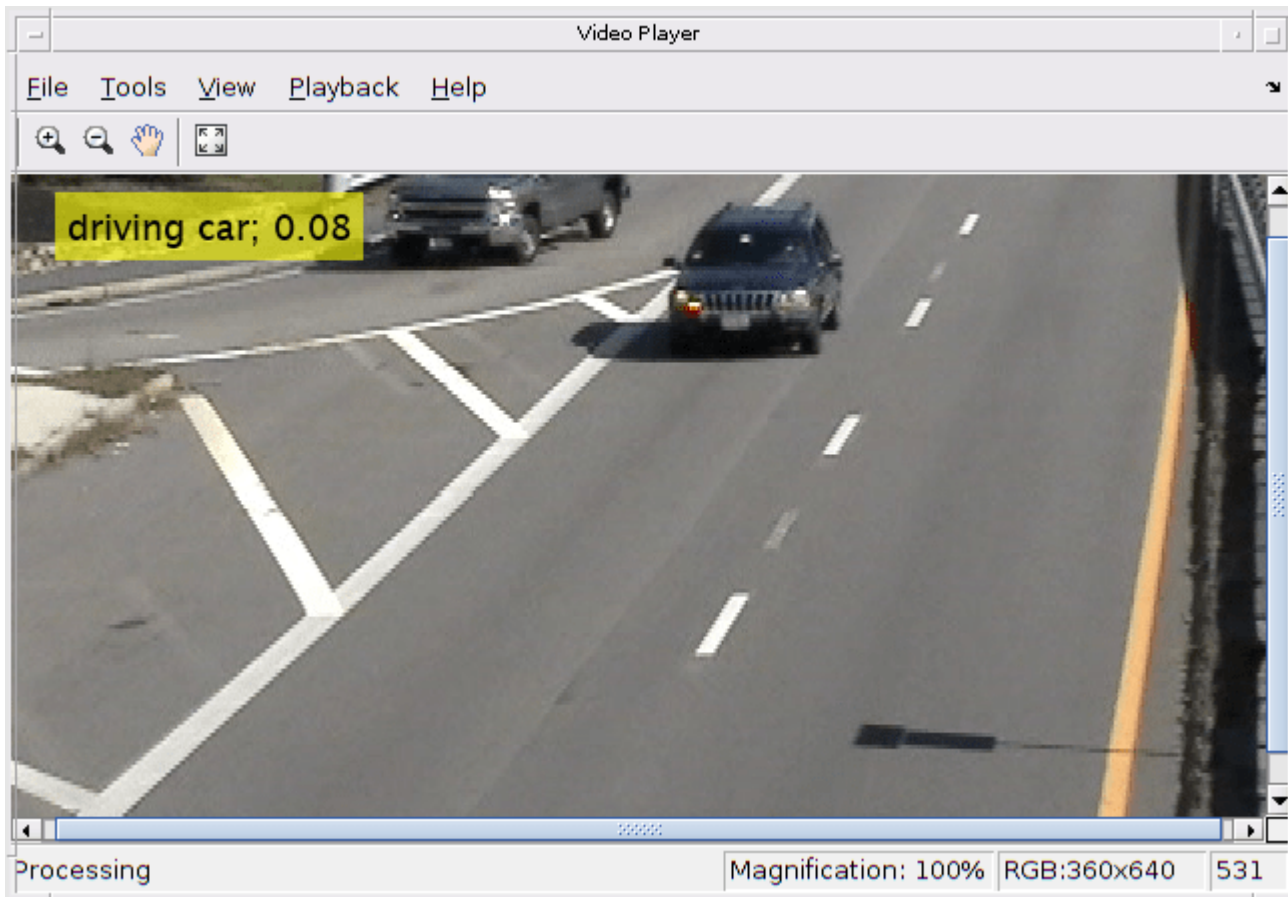

See Also

Apps

[Video Labeler](#)

Functions

[sceneTimeRanges](#) | [writeVideoScenes](#)

Objects

[dlnetwork](#) | [inflated3dVideoClassifier](#) | [slowFastVideoClassifier](#)

Topics

[“Getting Started with Video Classification Using Deep Learning”](#)

[“Evaluate a Video Classifier”](#)

[“Activity Recognition Using R\(2+1\)D Video Classification”](#)

[“Gesture Recognition using Videos and Deep Learning”](#)

[“Classify Streaming Webcam Video Using SlowFast Video Classifier”](#)

Introduced in R2021b

classifySequence

Classify video sequence

Syntax

```
label = classifySequence(classifier)
[label,score] = classifySequence(classifier)
[___] = classifySequence(classifierObj,ExecutionEnvironment=env)
```

Description

`label = classifySequence(classifier)` classifies a video sequence using the video classifier `classifier`. The function returns `label`, a scalar categorical that specifies the classification of the video or optical flow sequence. `label` is one of the values of the `Classes` property of the video classifier object.

`[label,score] = classifySequence(classifier)` additionally returns the classification score associated with the label. The score represents the confidence of the predicted class label, and contains values between 0 and 1.

`[___] = classifySequence(classifierObj,ExecutionEnvironment=env)` specifies the hardware resources for running the classifier in addition to any combination of arguments from previous syntaxes, as one of these options:

- "auto" — Sets the execution environment to the GPU, if available. Otherwise the function sets it to the CPU.
- "gpu" — Sets the execution environment to the GPU. Usage of the GPU requires Parallel Computing Toolbox™ and a CUDA enabled NVIDIA® GPU. For information about the supported compute capabilities, see "GPU Support by Release" (Parallel Computing Toolbox).
- "cpu" — Sets the execution environment to the CPU.

Examples

Classify Video Sequences in a Video File

This example shows how to classify video sequences in a video file using a SlowFast Video Classifier pretrained on the Kinetics-400 video activity recognition dataset. To learn more about how to train a video classifier network for your dataset, see "Gesture Recognition using Videos and Deep Learning".

Load SlowFast Video Classifier

```
sf = slowFastVideoClassifier();
```

Setup Video Player and Video Reader

Specify the video file name to stream video frames.

```
videoFilename = "pushup.mp4";
```

Create a VideoReader to read video.

```
reader = VideoReader(videoFilename);
```

Setup a video player.

```
player = vision.VideoPlayer;
```

Classify Video Sequences

Specify how frequently the classifier should be applied to incoming video frames.

```
classifyInterval = 10;
```

A value of 10 balances runtime performance against classification performance. Increase this value to improve runtime performance at the cost of missing actions from the video file.

Obtain the sequence length of the SlowFast Video Classifier. Classify only after capturing at least `sequenceLength` number of frames from the video file.

```
sequenceLength = sf.InputSize(4);
```

Read video frames using the `hasFrame` and `readFrame` functions of the `VideoReader`. Using the `updateSequence` function update the video classifier's sequence. Using the `classifySequence` function classify the updated sequence.

```
numFrames = 0;
```

```
text = "";
```

```
while hasFrame(reader)
```

```
    frame = readFrame(reader);
```

```
    numFrames = numFrames + 1;
```

```
    % Update the sequence with the next video frame.
```

```
    sf = updateSequence(sf,frame);
```

```
    % Classify the sequence only at every classifyInterval number of frames.
```

```
    if mod(numFrames, classifyInterval) == 0 && numFrames >= sequenceLength
```

```
        [label,score] = classifySequence(sf);
```

```
        text = string(label) + "; " + num2str(score, "%0.2f");
```

```
    end
```

```
    frame = insertText(frame,[30,30],text,'FontSize',24);
```

```
    step(player,frame);
```

```
end
```

Video Player

File Tools View Playback Help

+ - Hand Full Screen



Processing Magnification: 100% RGB:364x640 163

Classify Streaming Webcam Video Using SlowFast Video Classifier

This example shows how to classify a streaming video from a webcam using a pretrained SlowFast Video Classifier. To learn more about how to train a video classifier network for your dataset, see “Gesture Recognition using Videos and Deep Learning”.

Download Pretrained Video Classifier

Download the pretrained SlowFast video classifier.

```
downloadFolder = fullfile(tempdir,"gesture");
zipFile = "slowFastPretrained_fourClasses.zip";
if ~isfile(fullfile(downloadFolder,zipFile))
    disp("Downloading the pretrained network...");
    downloadURL = "https://ssd.mathworks.com/supportfiles/vision/data/" + zipFile;
    zipFile = fullfile(downloadFolder,zipFile);
    websave(zipFile,downloadURL);
    unzip(zipFile,downloadFolder);
end
```

Load the pretrained SlowFast video classifier.

```
pretrainedDataFile = fullfile(downloadFolder,"slowFastPretrained_fourClasses.mat");
pretrained = load(pretrainedDataFile);
slowFastClassifier = pretrained.data.slowFast;
```

Display the class label names of the pretrained video classifier. Any gesture such as "clapping" and "wavingHello" on to the webcam will be recognized by the SlowFast Video Classifier.

```
classes = slowFastClassifier.Classes
```

```
classes = 4×1 categorical
    clapping
    noAction
    somethingElse
    wavingHello
```

Setup the Webcam and the Video Player

In this example, a webcam object is used to capture streaming video. A Video Player is used to display the streaming video along with the predicted class.

Create a webcam object using the `webcam` function.

```
cam = webcam;
```

Create a Video Player using `vision.VideoPlayer` function. Make sure to place the Video Player in a position where you can clearly see the streaming video when running the classification.

```
player = vision.VideoPlayer;
```

Classify the Webcam Streaming Video

Specify how frequently the classifier should be applied to incoming video frames.

```
classifyInterval = 10;
```

A value of 10 balances runtime performance against classification performance. Increase this value to improve runtime performance at the cost of missing gestures from the live video stream.

Obtain the sequence length of the SlowFast Video Classifier. Classify only after capturing at least `sequenceLength` number of frames from the webcam.

```
sequenceLength = slowFastClassifier.InputSize(4);
```

Specify the maximum number of frames to capture in a loop using the `maxNumFrames` variable. Make sure you wave one of your hands to recognize "wavingHello" label, and clap using both your hands for the classifier to recognize "clapping" label.

```
maxNumFrames = 280;
```

Capture the webcam snapshot in a loop. Update the streaming video sequence of the classifier using the `updateSequence` method, and classify the streaming sequence using the `classifySequence` method.

```
numFrames = 0;
```

```
text = "";
```

```
while numFrames <= maxNumFrames
```

```
    frame = snapshot(cam);
```

```
    numFrames = numFrames + 1;
```

```
    slowFastClassifier = updateSequence(slowFastClassifier, frame);
```

```
    if mod(numFrames, classifyInterval) == 0 && numFrames >= sequenceLength
```

```
        [label, scores] = classifySequence(slowFastClassifier);
```

```
        if ~isempty(label)
```

```
            text = string(label) + "; " + num2str(max(scores), "%0.2f");
```

```
        end
```

```
    end
```

```
    frame = insertText(frame, [30,30], text, 'FontSize', 18);
```

```
    step(player, frame);
```

```
end
```

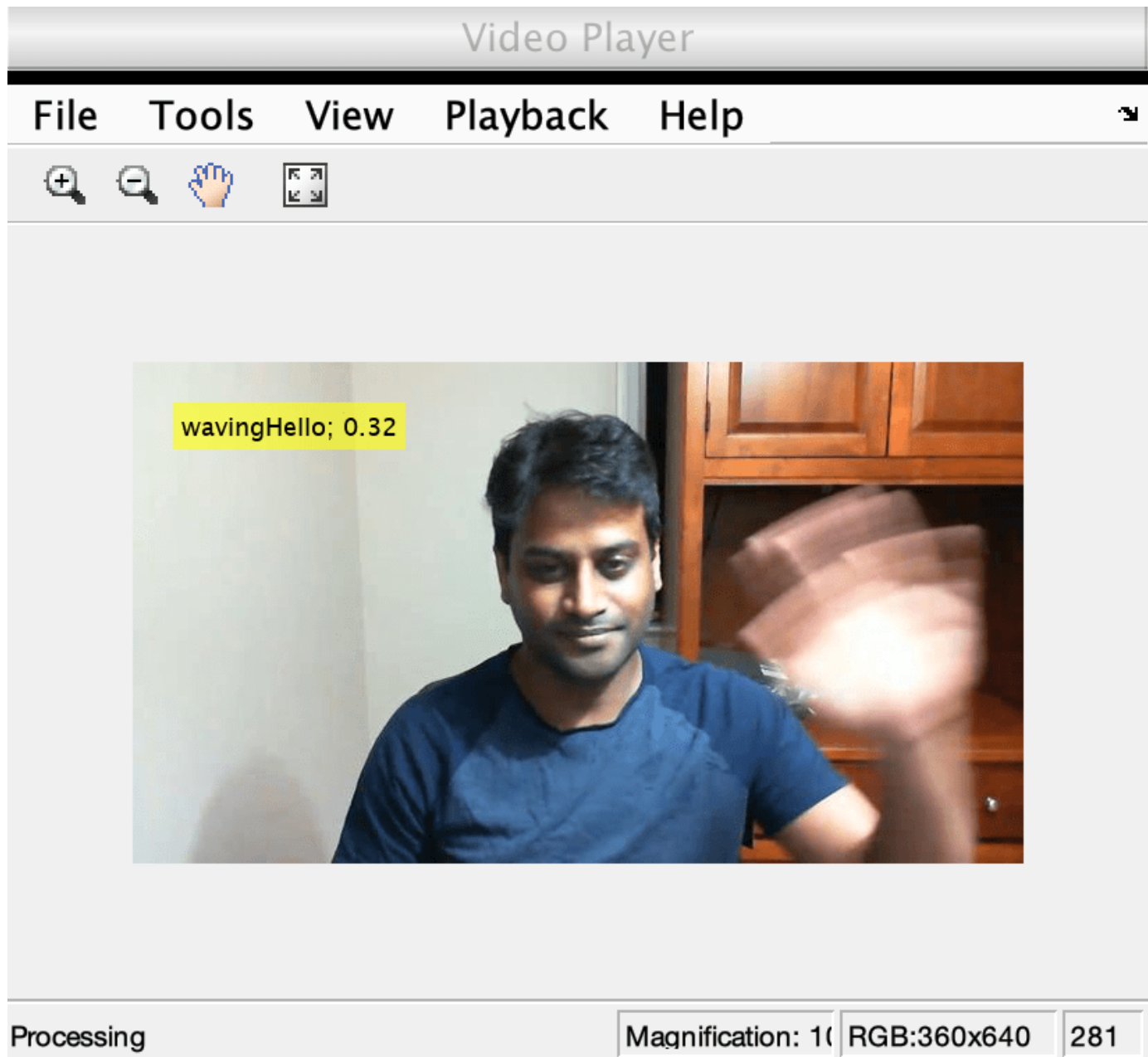

Input Arguments

classifier – Classifier

r2plus1dVideoClassifier object | slowFastVideoClassifier object

Classifier, specified as a r2plus1dVideoClassifier or slowFastVideoClassifier object.

Output Arguments

label – Classification of video or optical flow sequence

categorical scalar

Classification of the video or optical flow sequence, returned as a categorical scalar.

score — Classification score associated with the label

scalar value between 0 and 1

Classification score associated with the label, returned as a scalar value between 0 and 1. The score represents the confidence of the predicted class label.

See Also

Functions

`sceneTimeRanges` | `writeVideoScenes` | `updateSequence` | `classifyVideoFile` | `predict` | `forward` | `resetSequence`

Objects

`r2plus1dVideoClassifier` | `slowFastVideoClassifier` | `inflated3dVideoClassifier`

Topics

“Getting Started with Video Classification Using Deep Learning”

“Evaluate a Video Classifier”

“Classify Streaming Webcam Video Using SlowFast Video Classifier”

Introduced in R2021b

classifySequence

Classify video and optical flow sequence

Syntax

```
label = classifySequence(i3d)
[label,score] = classifySequence(i3d)
[___] = classifySequence(i3d,ExecutionEnvironment=env)
```

Description

`label = classifySequence(i3d)` classifies a video and optical flow sequence using the Inflated-3D (I3D) video classifier `i3d`. The function returns `label`, a scalar categorical that specifies the classification of the video or optical flow sequence. `label` is one of the values of the `Classes` property of the video classifier object.

`[label,score] = classifySequence(i3d)` additionally returns the classification score associated with the label. The score represents the confidence of the predicted class label, and contains values between 0 and 1.

`[___] = classifySequence(i3d,ExecutionEnvironment=env)` specifies the hardware resources for running the classifier in addition to any combination of arguments from previous syntaxes, as one of these options:

- "auto" — Sets the execution environment to the GPU, if available. Otherwise the function sets it to the CPU.
- "gpu" — Sets the execution environment to the GPU. Usage of the GPU requires Parallel Computing Toolbox and a CUDA enabled NVIDIA GPU. For information about the supported compute capabilities, see "GPU Support by Release" (Parallel Computing Toolbox).
- "cpu" — Sets the execution environment to the CPU.

Examples

Classify Video Sequences in a Video File

This example shows how to classify video sequences in a video file using a SlowFast Video Classifier pretrained on the Kinetics-400 video activity recognition dataset. To learn more about how to train a video classifier network for your dataset, see "Gesture Recognition using Videos and Deep Learning".

Load SlowFast Video Classifier

```
sf = slowFastVideoClassifier();
```

Setup Video Player and Video Reader

Specify the video file name to stream video frames.

```
videoFilename = "pushup.mp4";
```

Create a VideoReader to read video.

```
reader = VideoReader(videoFilename);
```

Setup a video player.

```
player = vision.VideoPlayer;
```

Classify Video Sequences

Specify how frequently the classifier should be applied to incoming video frames.

```
classifyInterval = 10;
```

A value of 10 balances runtime performance against classification performance. Increase this value to improve runtime performance at the cost of missing actions from the video file.

Obtain the sequence length of the SlowFast Video Classifier. Classify only after capturing at least `sequenceLength` number of frames from the video file.

```
sequenceLength = sf.InputSize(4);
```

Read video frames using the `hasFrame` and `readFrame` functions of the `VideoReader`. Using the `updateSequence` function update the video classifier's sequence. Using the `classifySequence` function classify the updated sequence.

```
numFrames = 0;
```

```
text = "";
```

```
while hasFrame(reader)
```

```
    frame = readFrame(reader);
```

```
    numFrames = numFrames + 1;
```

```
    % Update the sequence with the next video frame.
```

```
    sf = updateSequence(sf,frame);
```

```
    % Classify the sequence only at every classifyInterval number of frames.
```

```
    if mod(numFrames, classifyInterval) == 0 && numFrames >= sequenceLength
```

```
        [label,score] = classifySequence(sf);
```

```
        text = string(label) + "; " + num2str(score, "%0.2f");
```

```
    end
```

```
    frame = insertText(frame,[30,30],text,'FontSize',24);
```

```
    step(player,frame);
```

```
end
```



Input Arguments

i3d – Classifier

inflated3dVideoClassifier object

Classifier, specified as an `inflated3dVideoClassifier` object.

Output Arguments

label – Classification of video or optical flow sequence

categorical scalar

Classification of the video or optical flow sequence, returned as a categorical scalar.

score — Classification score associated with the label

scalar value between 0 and 1

Classification score associated with the label, returned as a scalar value between 0 and 1. The score represents the confidence of the predicted class label.

See Also

Functions

`sceneTimeRanges` | `writeVideoScenes` | `classifyVideoFile` | `resetSequence` | `updateSequence` | `predict` | `forward`

Objects

`r2plus1dVideoClassifier` | `slowFastVideoClassifier` | `inflated3dVideoClassifier`

Topics

“Getting Started with Video Classification Using Deep Learning”

“Evaluate a Video Classifier”

“Classify Streaming Webcam Video Using SlowFast Video Classifier”

Introduced in R2021b

classifyVideoFile

Classify a video file

Syntax

```
label = classifyVideoFile(classifier,videoFilename)
[label,score] = classifyVideoFile(____)
[____] = classifySequence(____,Name=Value)
```

Description

`label = classifyVideoFile(classifier,videoFilename)` predicts the class label for the video file, specified by `videoFilename` using the specified classifier `classifier`. The video file must be readable by the `VideoReader` object.

Use the `classifyVideoFile` object function for applications where the entire input video can be classified with one label. For example, you can use this object function to evaluate the performance of the classifier on a collection of ground truth video files. If the video contains sequences with different class labels, use the `classifySequence` object function.

This function selects sequences of frames from the video file using uniform random sampling to select the start of time of each sequence. The number of frames is set by the `InputSize` property of the classifier object. The function selects the most frequently occurring label in the video file as the classification label for the file. The video file must contain at least the number of frames set by the `InputSize` property.

`[label,score] = classifyVideoFile(____)` additionally returns the classification score associated with the label using the combination of input arguments from the previous syntax. The score represents the confidence of the predicted class label and contains values between 0 and 1.

`[____] = classifySequence(____,Name=Value)` specifies options using name-value arguments in addition to any combination of arguments from previous syntaxes. For example, `label = classifySequence(i3d,ExecutionEnvironment="cpu")` specifies for the classifier to run on the CPU.

Examples

Classify Video File Using Video Classifier

Load a slowfast video classifier pretrained on the Kinetics-400 data set.

```
sf = slowFastVideoClassifier;
```

Specify the file name of the video to classify.

```
videoFilename = "washingHands.avi";
```

For video classification, set the number of randomly selected video sequences to 15.

```
numSequences = 15;
```

Classify the video using the `classifyVideoFile` function.

```
[label,score] = classifyVideoFile(sf,videoFilename,NumSequences=numSequences)
```

```
label = categorical  
      washing hands
```

```
score = single  
      0.0034
```

Display the classified label using a `vision.VideoPlayer`.

```
player = vision.VideoPlayer('Name','Washing Hands');  
reader = VideoReader(videoFilename);  
while hasFrame(reader)  
    frame = readFrame(reader);  
    % Resize the frame by 1.5 times for display  
    frame = imresize(frame,1.5);  
    frame = insertText(frame,[2,2], string(label),'FontSize',18);  
    step(player,frame);  
end
```

Washing Hands

File Tools View Playback Help

+ - 👤 🖱️



Processing Magnification: 100% RGB:405x720 224

Input Arguments

classifier – Classifier

inflated3dVideoClassifier object | r2plus1dVideoClassifier object | slowFastVideoClassifier object

Classifier, specified as an inflated3dVideoClassifier, r2plus1dVideoClassifier, or slowFastVideoClassifier object.

videoFilename – Video file name

character vector | string scalar

Video file name, specified as a character vector or a string scalar. The video file must be readable by the VideoReader object.

Name-Value Pair Arguments

Specify optional pairs of arguments as Name1=Value1, . . . , NameN=ValueN, where Name is the argument name and Value is the corresponding value. Name-value arguments must appear after other arguments, but the order of the pairs does not matter.

Example: `label = classifySequence(i3d, ExecutionEnvironment="cpu")` specifies for the classifier to run on the CPU.

ExecutionEnvironment — Hardware execution environment

"auto" (default) | "gpu" | "cpu"

Hardware execution environment on which to run the classifier, specified as "auto", "gpu", or "cpu".

- "auto" — Sets the execution environment to the GPU, if available. Otherwise the function sets it to the CPU.
- "gpu" — Sets the execution environment to the GPU. Usage of the GPU requires Parallel Computing Toolbox and a CUDA enabled NVIDIA GPU. For information about the supported compute capabilities, see “GPU Support by Release” (Parallel Computing Toolbox).
- "cpu" — Sets the execution environment to the CPU.

NumSequences — Maximum number of sequences to sample from video file

"auto" (default) | positive integer

Maximum number of sequences to sample from the video file, specified as "auto" or a positive integer. When you set this value to "auto", the function sets the number of sequences to twice the number of sequences that can be selected from the video file based on the number of frames available. The "auto" setting provides a uniform coverage of the entire video. Increasing the value of NumSequences increases the uniform coverage of the video.

MiniBatchSize — Mini-batch size for processing a large video

16 | positive integer

Mini-batch size used for processing a large video, specified as a positive integer. Video sequences are grouped and processed in mini-batches to improve computational efficiency. Increasing the value of MiniBatchSize increases processing speed, but uses more memory.

Output Arguments

label — Classification of video

categorical scalar

Classification of video, returned as a categorical scalar.

score — Classification score associated with the label

scalar value between 0 and 1

Classification score associated with the label, returned as a scalar value between 0 and 1. The score represents the confidence of the predicted class label.

See Also

Objects

`inflated3dVideoClassifier` | `slowFastVideoClassifier` | `r2plus1dVideoClassifier`

Topics

“Getting Started with Video Classification Using Deep Learning”

“Evaluate a Video Classifier”

“Classify Streaming Webcam Video Using SlowFast Video Classifier”

Introduced in R2021b

forward

Compute video classifier outputs for training

Syntax

```
dLYVideo = forward(classifier,dLXVideo)
[dLYVideo,stateVideo] = forward(classifier,dLXVideo)
[dLYVideo,dLYFlow] = forward(classifier,dLXVideo,dLXFlow)
[dLYVideo,dLYFlow,stateVideo,stateFlow] = forward(classifier,dLXVideo,
dLXFlow)
```

Description

`dLYVideo = forward(classifier,dLXVideo)` computes the video classifier outputs for training. You can use this function with `dlfeval` to automatically compute gradients for updating the learnable parameters of the video classifier. `classifier` is specified as a `r2plus1dVideoClassifier` or `slowFastVideoClassifier` classifier object.

`[dLYVideo,stateVideo] = forward(classifier,dLXVideo)` also returns the updated video network state. The output, `stateVideo`, contains information maintained by the classifier between training iterations. For example, the state of batch normalization operation.

`[dLYVideo,dLYFlow] = forward(classifier,dLXVideo,dLXFlow)` also returns the optical flow outputs from the classifier for training. Use this syntax when you set the `OpticalFlowMethod` property of the classifier object to "Farneback".

`[dLYVideo,dLYFlow,stateVideo,stateFlow] = forward(classifier,dLXVideo,dLXFlow)` also returns the updated video network and the optical flow network states.

Examples

Compute Video Classifier Outputs for Training

This example shows how to compute video classifier outputs for training. To learn more about how to train a video classifier network for your dataset, see "Gesture Recognition using Videos and Deep Learning".

Load a video classifier pretrained on the Kinetics-400 data set.

```
sf = slowFastVideoClassifier;
```

Specify the video file name.

```
videoFilename = "washingHands.avi";
```

Create a `VideoReader` to read the video frames.

```
reader = VideoReader(videoFilename);
```

Read the required number of video frames corresponding to the video classifier network from the beginning of the video file. The required number of frames is defined by the value of the 4th element of the `InputSize` property of the video classifier.

```
sequenceLength = sf.InputSize(4);
sequenceRange = [1,sequenceLength];
videoFrames = read(reader,sequenceRange);
```

Resize the video frames for training. The required height and width are defined by the first two elements of the `InputSize` property of the video classifier.

```
heightWidth = sf.InputSize(1:2);
resized = imresize(videoFrames,heightWidth);
```

Convert the input to type `single`.

```
resized = single(resized);
```

Rescale the input between 0 and 1.

```
minValue = sf.InputNormalizationStatistics.Min;
maxValue = sf.InputNormalizationStatistics.Max;
minValue = reshape(minValue,1,1,3);
maxValue = reshape(maxValue,1,1,3);
resized = rescale(resized,0,1,InputMin=minValue,InputMax=maxValue);
```

Normalize the video data using the mean and standard deviation.

```
meanValue = sf.InputNormalizationStatistics.Mean;
stdValue = sf.InputNormalizationStatistics.StandardDeviation;
meanValue = reshape(meanValue,1,1,3);
stdValue = reshape(stdValue,1,1,3);
resized = resized - meanValue;
resized = resized./stdValue;
```

Convert the input to a `dlarray` object.

```
dlVideo = dlarray(resized,"SSCTB");
trainingActivations = forward(sf,dlVideo);
```

Find the class label corresponding to the maximum score.

```
[score,idx] = max(trainingActivations);
label = sf.Classes(idx)
```

```
label = categorical
      washing hands
```

`score`

```
score =
  1(S) × 1(S) × 1(S) × 1(C) × 1(B) single dlarray
  0.0026
```

Display the class label.

```

frame = videoFrames(:,:,:,end);
frame = insertText(frame,[2,2],string(label),FontSize=24);
imshow(frame)

```



Input Arguments

classifier – Classifier object

`r2plus1dVideoClassifier` object | `slowFastVideoClassifier` object

Classifier object, specified as a `r2plus1dVideoClassifier` or `slowFastVideoClassifier` object.

dLXVideo – Video input

H-by-W-by-C-by-T-by-B SSCTB formatted `darray` object

Video input, specified as an *H-by-W-by-C-by-T-by-B* SSCTB formatted `darray` object that corresponds to the video input of the classifier.

- *H* – Height.
- *W* – Width.
- *C* – Number of channels. The number of channels must be equal to the `channels` value of the `InputSize` property of the classifier object.
- *T* – Number of frames. The number of frames must be equal to the `frames` value of the `InputSize` property of the classifier object.
- *B* – Batch size.

dLXFlow – Video and optical flow input

SSCTB formatted `darray` object

Video and optical flow input, specified as an *H-by-W-by-C-by-T-by-B* SSCTB formatted `darray` object that corresponds to the video and optical flow input of the classifier.

- *H* — Height.
- *W* — Width.
- *C* — Number of channels. The number of channels must be equal to the `channels` value of the `InputSize` property of the classifier object.
- *T* — Number of frames. The number of frames must be equal to the `frames` value of the `InputSize` property of the classifier object.
- *B* — Batch size.

Output Arguments

dLYVideo — Activations of video network

`darray` object

Activations of the video network, returned as a formatted `darray` object .

stateVideo — Updated video network state

table

Updated video network state, returned as a table with three columns:

- `Layer` — Layer name, specified as a string scalar.
- `Parameter` — Parameter name, specified as a string scalar.
- `Value` — Value of the parameter, specified as a `darray` object.

The network state contains information remembered by the network between iterations. For example, the state of the LSTM and batch normalization layers.

During training or inference, you can update the network state using the output of the `forward` and `predict` functions.

dLYFlow — Activations of optical flow network

`darray` object

Activations of the optical flow network, returned as a formatted `darray` object .

stateFlow — Updated optical flow network state

table

Updated optical flow network state, returned as a table with three columns:

- `Layer` — Layer name, specified as a string scalar.
- `Parameter` — Parameter name, specified as a string scalar.
- `Value` — Value of the parameter, specified as a `darray` object.

The network state contains information remembered by the network between iterations. For example, the state of LSTM and batch normalization layers.

During training or inference, you can update the network state using the output of the `forward` and `predict` functions.

See Also

Functions

sceneTimeRanges | writeVideoScenes | classifySequence | updateSequence |
classifyVideoFile | predict

Objects

r2plus1dVideoClassifier | slowFastVideoClassifier | inflated3dVideoClassifier

Topics

“Gesture Recognition using Videos and Deep Learning”

Introduced in R2021b

forward

Compute video classifier outputs for training

Syntax

```
dLYVideo = forward(i3d,dLXVideo)
[dLYVideo,stateVideo] = forward(i3d,dLXVideo)
[dLYVideo,dLYFlow] = forward(i3d,dLXVideo,dLXFlow)
[dLYVideo,dLYFlow,stateVideo,stateFlow] = forward(i3d,dLXVideo,dLXFlow)
```

Description

`dLYVideo = forward(i3d,dLXVideo)` computes the video classifier outputs for training. You can use this function with `dlfeval` to automatically compute gradients for updating the learnable parameters of the video classifier. `i3d` is specified as an `inflated3dVideoClassifier` classifier object. Use this syntax when you set the `OpticalFlowMethod` property of the classifier object to "none".

`[dLYVideo,stateVideo] = forward(i3d,dLXVideo)` also returns the updated video network state. The output, `stateVideo`, contains information maintained by the classifier between training iterations. For example, the state of batch normalization operation.

`[dLYVideo,dLYFlow] = forward(i3d,dLXVideo,dLXFlow)` also returns the optical flow outputs from the classifier for training. Use this syntax when you set the `OpticalFlowMethod` property of the classifier object to "Farneback".

`[dLYVideo,dLYFlow,stateVideo,stateFlow] = forward(i3d,dLXVideo,dLXFlow)` also returns the updated video network and the optical flow network states.

Examples

Compute Video Classifier Outputs for Training

This example shows how to compute video classifier outputs for training. To learn more about how to train a video classifier network for your dataset, see "Gesture Recognition using Videos and Deep Learning".

Load a video classifier pretrained on the Kinetics-400 data set.

```
sf = slowFastVideoClassifier;
```

Specify the video file name.

```
videoFilename = "washingHands.avi";
```

Create a `VideoReader` to read the video frames.

```
reader = VideoReader(videoFilename);
```

Read the required number of video frames corresponding to the video classifier network from the beginning of the video file. The required number of frames is defined by the value of the 4th element of the `InputSize` property of the video classifier.

```
sequenceLength = sf.InputSize(4);
sequenceRange = [1,sequenceLength];
videoFrames = read(reader,sequenceRange);
```

Resize the video frames for training. The required height and width are defined by the first two elements of the `InputSize` property of the video classifier.

```
heightWidth = sf.InputSize(1:2);
resized = imresize(videoFrames,heightWidth);
```

Convert the input to type `single`.

```
resized = single(resized);
```

Rescale the input between 0 and 1.

```
minValue = sf.InputNormalizationStatistics.Min;
maxValue = sf.InputNormalizationStatistics.Max;
minValue = reshape(minValue,1,1,3);
maxValue = reshape(maxValue,1,1,3);
resized = rescale(resized,0,1,InputMin=minValue,InputMax=maxValue);
```

Normalize the video data using the mean and standard deviation.

```
meanValue = sf.InputNormalizationStatistics.Mean;
stdValue = sf.InputNormalizationStatistics.StandardDeviation;
meanValue = reshape(meanValue,1,1,3);
stdValue = reshape(stdValue,1,1,3);
resized = resized - meanValue;
resized = resized./stdValue;
```

Convert the input to a `darray` object.

```
dlVideo = darray(resized,"SSCTB");
trainingActivations = forward(sf,dlVideo);
```

Find the class label corresponding to the maximum score.

```
[score,idx] = max(trainingActivations);
label = sf.Classes(idx)
```

```
label = categorical
      washing hands
```

score

```
score =
  1(S) × 1(S) × 1(S) × 1(C) × 1(B) single darray
  0.0026
```

Display the class label.

```
frame = videoFrames(:,:,end);  
frame = insertText(frame,[2,2],string(label),FontSize=24);  
imshow(frame)
```



Input Arguments

i3d – Classifier

`inflated3dVideoClassifier` object

Classifier, specified as an `inflated3dVideoClassifier` object.

dLXVideo – Video input

H-by-W-by-C-by-T-by-B SSCTB formatted `dLarray` object

Video input, specified as an *H-by-W-by-C-by-T-by-B* SSCTB formatted `dLarray` object that corresponds to the video input of the classifier.

- *H* – Height.
- *W* – Width.
- *C* – Number of channels. The number of channels must be equal to the `channels` value of the `InputSize` property of the classifier object.
- *T* – Number of frames. The number of frames must be equal to the `frames` value of the `InputSize` property of the classifier object.
- *B* – Batch size.

dLXFlow – Video and optical flow input

SSCTB formatted `dLarray` object

Video and optical flow input, specified as an H -by- W -by- C -by- T -by- B SSCTB formatted `darray` object that corresponds to the video and optical flow input of the classifier.

- H — Height.
- W — Width.
- C — Number of channels. The number of channels must be equal to the channels value of the `InputSize` property of the classifier object.
- T — Number of frames. The number of frames must be equal to the frames value of the `InputSize` property of the classifier object.
- B — Batch size.

Output Arguments

dLYVideo — Activations of video network

`darray` object

Activations of the video network, returned as a formatted `darray` object .

stateVideo — Updated video network state

table

Updated video network state, returned as a table with three columns:

- `Layer` — Layer name, specified as a string scalar.
- `Parameter` — Parameter name, specified as a string scalar.
- `Value` — Value of the parameter, specified as a `darray` object.

The network state contains information remembered by the network between iterations. For example, the state of the LSTM and batch normalization layers.

During training or inference, you can update the network state using the output of the `forward` and `predict` functions.

dLYFlow — Activations of optical flow network

`darray` object

Activations of the optical flow network, returned as a formatted `darray` object .

stateFlow — Updated optical flow network state

table

Updated optical flow network state, returned as a table with three columns:

- `Layer` — Layer name, specified as a string scalar.
- `Parameter` — Parameter name, specified as a string scalar.
- `Value` — Value of the parameter, specified as a `darray` object.

The network state contains information remembered by the network between iterations. For example, the state of LSTM and batch normalization layers.

During training or inference, you can update the network state using the output of the `forward` and `predict` functions.

See Also

Functions

`sceneTimeRanges` | `writeVideoScenes` | `classifySequence` | `updateSequence` | `classifyVideoFile` | `predict` | `resetSequence`

Objects

`r2plus1dVideoClassifier` | `slowFastVideoClassifier` | `inflated3dVideoClassifier`

Introduced in R2021b

predict

Compute video classifier predictions

Syntax

```
dLYVideo = predict(classifier,dLXVideo)
[dLYVideo,stateVideo] = predict(classifier,dLXVideo)
[dLYVideo,dLYFlow] = predict(classifier,dLXVideo,dLXFlow)
[dLYVideo,dLYFlow,stateVideo,stateFlow] = predict(classifier,dLXVideo,
dLXFlow)
```

Description

`dLYVideo = predict(classifier,dLXVideo)` computes the predictions of the video classifier. `classifier` is specified as a `r2plus1dVideoClassifier` or `slowFastVideoClassifier` classifier object.

`[dLYVideo,stateVideo] = predict(classifier,dLXVideo)` also returns the updated video network state. The output, `stateVideo`, contains information between training iterations maintained by the classifier. For example, the state of batch normalization operation.

`[dLYVideo,dLYFlow] = predict(classifier,dLXVideo,dLXFlow)` also returns the optical flow predictions from the classifier for training. Use this syntax when you set the `OpticalFlowMethod` property of the classifier object to "Farneback".

`[dLYVideo,dLYFlow,stateVideo,stateFlow] = predict(classifier,dLXVideo,dLXFlow)` also returns the updated video network and the optical flow network states.

Examples

Compute Predictions for Video Using Video Classifier

This example shows how to compute predictions for a video using a video classifier. To learn more about how to train a video classifier network for your dataset, see "Gesture Recognition using Videos and Deep Learning".

Load a video classifier pretrained on the Kinetics-400 data set.

```
sf = slowFastVideoClassifier;
```

Specify the video file name.

```
videoFilename = "pushup.mp4";
```

Create a `VideoReader` to read the video frames.

```
reader = VideoReader(videoFilename);
```

Read the required number of video frames corresponding to the video classifier network, from the beginning of the video file. The required number of frames is defined by the value of the 4th element of the `InputSize` property of the video classifier.

```
sequenceLength = sf.InputSize(4);
sequenceRange = [1, sequenceLength];
videoFrames = read(reader, sequenceRange);
```

Resize video frames for prediction. The required height and width are defined by the first two elements of the `InputSize` property of the video classifier.

```
heightWidth = sf.InputSize(1:2);
resized = imresize(videoFrames, heightWidth);
```

Convert the input to type `single`.

```
resized = single(resized);
```

Rescale the input between 0 and 1.

```
minValue = sf.InputNormalizationStatistics.Min;
maxValue = sf.InputNormalizationStatistics.Max;
minValue = reshape(minValue, 1, 1, 3);
maxValue = reshape(maxValue, 1, 1, 3);
resized = rescale(resized, 0, 1, InputMin=minValue, InputMax=maxValue);
```

Normalize the video data using the mean and standard deviation.

```
meanValue = sf.InputNormalizationStatistics.Mean;
stdValue = sf.InputNormalizationStatistics.StandardDeviation;
meanValue = reshape(meanValue, 1, 1, 3);
stdValue = reshape(stdValue, 1, 1, 3);
resized = resized - meanValue;
resized = resized./stdValue;
```

Convert the input to `dlarray` object.

```
dlVideo = dlarray(resized, "SSCTB");
predictionScores = predict(sf, dlVideo);
```

Find the class label corresponding to the maximum score.

```
[score, idx] = max(predictionScores);
label = sf.Classes(idx)
```

```
label = categorical
      push up
```

Display the predicted class label and the score.

```
text = string(label) + "; " + num2str(score, "%0.2f");
frame = videoFrames(:, :, :, end);
frame = insertText(frame, [30, 30], text, FontSize=24);

imshow(frame)
```



Input Arguments

classifier – Classifier object

`r2plus1dVideoClassifier` object | `slowFastVideoClassifier` object

Classifier object, specified as a `r2plus1dVideoClassifier` or `slowFastVideoClassifier` object.

dLXVideo – Video input

H-by-W-by-C-by-T-by-B SSCTB formatted `dLarray` object

Video input, specified as an *H-by-W-by-C-by-T-by-B* SSCTB formatted `dLarray` object that corresponds to the video input of the classifier.

- *H* – Height.
- *W* – Width.
- *C* – Number of channels. The number of channels must be equal to the `channels` value of the `InputSize` property of the classifier object.
- *T* – Number of frames. The number of frames must be equal to the `frames` value of the `InputSize` property of the classifier object.
- *B* – Batch size.

dLXFlow – Video and optical flow input

SSCTB formatted `dLarray` object

Video and optical flow input, specified as an *H-by-W-by-C-by-T-by-B* SSCTB formatted `dLarray` object that corresponds to the video and optical flow input of the classifier.

- H — Height.
- W — Width.
- C — Number of channels. The number of channels must be equal to the channels value of the `InputSize` property of the classifier object.
- T — Number of frames. The number of frames must be equal to the frames value of the `InputSize` property of the classifier object.
- B — Batch size.

Output Arguments

dLYVideo — Activations of video network

`dLarray` object

Activations of the video network, returned as a formatted `dLarray` object .

stateVideo — Updated video network state

table

Updated video network state, returned as a table with three columns:

- `Layer` — Layer name, specified as a string scalar.
- `Parameter` — Parameter name, specified as a string scalar.
- `Value` — Value of the parameter, specified as a `dLarray` object.

The network state contains information remembered by the network between iterations. For example, the state of the LSTM and batch normalization layers.

During training or inference, you can update the network state using the output of the `forward` and `predict` functions.

dLYFlow — Activations of optical flow network

`dLarray` object

Activations of the optical flow network, returned as a formatted `dLarray` object .

stateFlow — Updated optical flow network state

table

Updated optical flow network state, returned as a table with three columns:

- `Layer` — Layer name, specified as a string scalar.
- `Parameter` — Parameter name, specified as a string scalar.
- `Value` — Value of the parameter, specified as a `dLarray` object.

The network state contains information remembered by the network between iterations. For example, the state of LSTM and batch normalization layers.

During training or inference, you can update the network state using the output of the `forward` and `predict` functions.

See Also

Functions

sceneTimeRanges | writeVideoScenes | classifySequence

Objects

r2plus1dVideoClassifier | slowFastVideoClassifier | inflated3dVideoClassifier

Topics

“Gesture Recognition using Videos and Deep Learning”

Introduced in R2021b

predict

Compute video classifier predictions

Syntax

```
dLYVideo = predict(i3d,dLXVideo)
[dLYVideo,stateVideo] = predict(i3d,dLXVideo)
[dLYVideo,dLYFlow] = predict(i3d,dLXVideo,dLXFlow)
[dLYVideo,dLYFlow,stateVideo,stateFlow] = predict(i3d,dLXVideo,dLXFlow)
```

Description

`dLYVideo = predict(i3d,dLXVideo)` computes the predictions of the video classifier. `i3d` is specified as an `inflated3dVideoClassifier`, `r2plus1dVideoClassifier`, or `slowFastVideoClassifier` classifier object. Use this syntax when you set the `OpticalFlowMethod` property of the classifier object to "none".

`[dLYVideo,stateVideo] = predict(i3d,dLXVideo)` also returns the updated video network state. The output, `stateVideo`, contains information between training iterations maintained by the classifier. For example, the state of batch normalization operation.

`[dLYVideo,dLYFlow] = predict(i3d,dLXVideo,dLXFlow)` also returns the optical flow predictions from the classifier for training. Use this syntax when you set the `OpticalFlowMethod` property of the classifier object to "Farneback".

`[dLYVideo,dLYFlow,stateVideo,stateFlow] = predict(i3d,dLXVideo,dLXFlow)` also returns the updated video network and the optical flow network states.

Examples

Compute Predictions for Video Using Video Classifier

This example shows how to compute predictions for a video using a video classifier. To learn more about how to train a video classifier network for your dataset, see "Gesture Recognition using Videos and Deep Learning".

Load a video classifier pretrained on the Kinetics-400 data set.

```
sf = slowFastVideoClassifier;
```

Specify the video file name.

```
videoFilename = "pushup.mp4";
```

Create a `VideoReader` to read the video frames.

```
reader = VideoReader(videoFilename);
```

Read the required number of video frames corresponding to the video classifier network, from the beginning of the video file. The required number of frames is defined by the value of the 4th element of the `InputSize` property of the video classifier.

```
sequenceLength = sf.InputSize(4);
sequenceRange = [1, sequenceLength];
videoFrames = read(reader, sequenceRange);
```

Resize video frames for prediction. The required height and width are defined by the first two elements of the `InputSize` property of the video classifier.

```
heightWidth = sf.InputSize(1:2);
resized = imresize(videoFrames, heightWidth);
```

Convert the input to type `single`.

```
resized = single(resized);
```

Rescale the input between 0 and 1.

```
minValue = sf.InputNormalizationStatistics.Min;
maxValue = sf.InputNormalizationStatistics.Max;
minValue = reshape(minValue, 1, 1, 3);
maxValue = reshape(maxValue, 1, 1, 3);
resized = rescale(resized, 0, 1, InputMin=minValue, InputMax=maxValue);
```

Normalize the video data using the mean and standard deviation.

```
meanValue = sf.InputNormalizationStatistics.Mean;
stdValue = sf.InputNormalizationStatistics.StandardDeviation;
meanValue = reshape(meanValue, 1, 1, 3);
stdValue = reshape(stdValue, 1, 1, 3);
resized = resized - meanValue;
resized = resized ./ stdValue;
```

Convert the input to `dlarray` object.

```
dlVideo = dlarray(resized, "SSCTB");
predictionScores = predict(sf, dlVideo);
```

Find the class label corresponding to the maximum score.

```
[score, idx] = max(predictionScores);
label = sf.Classes(idx)
```

```
label = categorical
      push up
```

Display the predicted class label and the score.

```
text = string(label) + "; " + num2str(score, "%0.2f");
frame = videoFrames(:, :, :, end);
frame = insertText(frame, [30, 30], text, FontSize=24);

imshow(frame)
```



Input Arguments

i3d — Classifier

`inflated3dVideoClassifier` object

Classifier, specified as an `inflated3dVideoClassifier` object.

dLXVideo — Video input

H-by-W-by-C-by-T-by-B SSCTB formatted `dLarray` object

Video input, specified as an *H-by-W-by-C-by-T-by-B* SSCTB formatted `dLarray` object that corresponds to the video input of the classifier.

- *H* — Height.
- *W* — Width.
- *C* — Number of channels. The number of channels must be equal to the `channels` value of the `InputSize` property of the classifier object.
- *T* — Number of frames. The number of frames must be equal to the `frames` value of the `InputSize` property of the classifier object.
- *B* — Batch size.

dLXFlow — Video and optical flow input

SSCTB formatted `dLarray` object

Video and optical flow input, specified as an *H-by-W-by-C-by-T-by-B* SSCTB formatted `dLarray` object that corresponds to the video and optical flow input of the classifier.

- H — Height.
- W — Width.
- C — Number of channels. The number of channels must be equal to the channels value of the `InputSize` property of the classifier object.
- T — Number of frames. The number of frames must be equal to the frames value of the `InputSize` property of the classifier object.
- B — Batch size.

Output Arguments

dLYVideo — Activations of video network

`dLarray` object

Activations of the video network, returned as a formatted `dLarray` object .

stateVideo — Updated video network state

table

Updated video network state, returned as a table with three columns:

- `Layer` — Layer name, specified as a string scalar.
- `Parameter` — Parameter name, specified as a string scalar.
- `Value` — Value of the parameter, specified as a `dLarray` object.

The network state contains information remembered by the network between iterations. For example, the state of the LSTM and batch normalization layers.

During training or inference, you can update the network state using the output of the `forward` and `predict` functions.

dLYFlow — Activations of optical flow network

`dLarray` object

Activations of the optical flow network, returned as a formatted `dLarray` object .

stateFlow — Updated optical flow network state

table

Updated optical flow network state, returned as a table with three columns:

- `Layer` — Layer name, specified as a string scalar.
- `Parameter` — Parameter name, specified as a string scalar.
- `Value` — Value of the parameter, specified as a `dLarray` object.

The network state contains information remembered by the network between iterations. For example, the state of LSTM and batch normalization layers.

During training or inference, you can update the network state using the output of the `forward` and `predict` functions.

See Also

Functions

sceneTimeRanges | writeVideoScenes | classifySequence | forward | resetSequence

Objects

r2plus1dVideoClassifier | slowFastVideoClassifier | inflated3dVideoClassifier

Topics

“Gesture Recognition using Videos and Deep Learning”

Introduced in R2021b

resetSequence

Reset video sequence properties for streaming video classification

Syntax

```
classifierReset = resetSequence(classifier)
```

Description

`classifierReset = resetSequence(classifier)` resets the video sequences for classification. `classifier` is the classifier, specified as a `r2plus1dVideoClassifier` or `slowFastVideoClassifier` object.

Examples

Classify Two Videos Using a Video Classifier

This example shows how to classify two different video sequences one after the other by resetting the video sequences of the video classifier using the `resetSequence` function. To learn more about how to train a video classifier network for your dataset, see “Gesture Recognition using Videos and Deep Learning”.

Load SlowFast Video Classifier

Load the SlowFast Video Classifier pretrained on the Kinetics-400 dataset.

```
sf = slowFastVideoClassifier();
```

Classify First Video Sequence

Specify the video file name.

```
videoFilename = "washingHands.avi";
```

Create a VideoReader to read the video frames.

```
reader = VideoReader(videoFilename);
```

Update the video classifier sequence with video frames before using `classifySequence`. The required number of frames is defined by the value of the 4th element of `InputSize` property of the video classifier.

```
sequenceLength = sf.InputSize(4);
```

Read a video sequence starting from the first frame.

```
startSequenceIndex = 1;  
sequenceRange = [startSequenceIndex, startSequenceIndex + sequenceLength - 1];
```

Update the video classifier sequence with video frames.

```
for ii = sequenceRange
    videoFrame = read(reader, ii);
    sf = updateSequence(sf,videoFrame);
end
```

Classify the video sequence updated so far.

```
[label1, score1] = classifySequence(sf)
```

```
label1 = categorical
        washing hands
```

```
score1 = single
        0.0031
```

Display the classified label.

```
player = vision.VideoPlayer('Name','Washing Hands');
for ii = sequenceRange
    frame = read(reader,ii);
    % Resize the frame by 1.5 times for display
    frame = imresize(frame,1.5);
    frame = insertText(frame,[2,2], string(label1),'FontSize',18);
    step(player,frame);
end
```

Washing Hands

File Tools View Playback Help

+ - Hand Full Screen



washing hands

Processing Magnification: 100% RGB:405x720 32

Classify Second Video Sequence

Reset the video sequence of the video classifier without creating a new video classifier.

```
sf = resetSequence(sf);
```

Specify another video file to classify.

```
videoFilename = "vipmen.avi";
```

Create a VideoReader to read the video frames.

```
reader = VideoReader(videoFilename);
```

Read a video sequence starting from the 131st frame, where the "shaking hands" action begins.

```
startSequenceIndex = 131;  
sequenceRange = [startSequenceIndex, startSequenceIndex + sequenceLength - 1];
```

Classify the second video sequence.

```
for ii = sequenceRange  
    videoFrame = read(reader,ii);  
    sf = updateSequence(sf,frame);  
end
```

```
[label2, score2] = classifySequence(sf)
```

```
label2 = categorical  
        shaking hands
```

```
score2 = single  
        0.0039
```

Display the classified label.

```
player = vision.VideoPlayer('Name','Shaking Hands');  
for ii = sequenceRange  
    frame = read(reader,ii);  
    % Resize the frame by 4 times for display  
    frame = imresize(frame, 4);  
    frame = insertText(frame,[2,2], string(label2),'FontSize',18);  
    step(player,frame);  
end
```

Shaking Hands

File Tools View Playback Help ▶

+ - 👤 ⏪ ⏩



Processing
Magnification: 100%
RGB:480x640
32

Input Arguments

classifier – Classifier

r2plus1dVideoClassifier object | slowFastVideoClassifier object

Classifier, specified as a r2plus1dVideoClassifier or slowFastVideoClassifier object.

Output Arguments

classifierReset – Reset video classifier

r2plus1dVideoClassifier object | slowFastVideoClassifier object

Reset video classifier, returned as a `r2plus1dVideoClassifier` or `slowFastVideoClassifier` object.

See Also

Functions

`sceneTimeRanges` | `writeVideoScenes` | `classifySequence` | `updateSequence` | `classifyVideoFile` | `predict` | `forward`

Objects

`r2plus1dVideoClassifier` | `slowFastVideoClassifier` | `inflated3dVideoClassifier`

Topics

“Classify Streaming Webcam Video Using SlowFast Video Classifier”

Introduced in R2021b

resetSequence

Reset video and optical flow sequence properties for streaming video classification

Syntax

```
i3dReset = resetSequence(i3d)
```

Description

`i3dReset = resetSequence(i3d)` resets the video and optical flow sequences for classification. `i3d` is the classifier, specified as an `inflated3dVideoClassifier` object.

Examples

Classify Two Videos Using a Video Classifier

This example shows how to classify two different video sequences one after the other by resetting the video sequences of the video classifier using the `resetSequence` function. To learn more about how to train a video classifier network for your dataset, see “Gesture Recognition using Videos and Deep Learning”.

Load SlowFast Video Classifier

Load the SlowFast Video Classifier pretrained on the Kinetics-400 dataset.

```
sf = slowFastVideoClassifier();
```

Classify First Video Sequence

Specify the video file name.

```
videoFilename = "washingHands.avi";
```

Create a `VideoReader` to read the video frames.

```
reader = VideoReader(videoFilename);
```

Update the video classifier sequence with video frames before using `classifySequence`. The required number of frames is defined by the value of the 4th element of `InputSize` property of the video classifier.

```
sequenceLength = sf.InputSize(4);
```

Read a video sequence starting from the first frame.

```
startSequenceIndex = 1;
sequenceRange = [startSequenceIndex, startSequenceIndex + sequenceLength - 1];
```

Update the video classifier sequence with video frames.

```
for ii = sequenceRange
    videoFrame = read(reader, ii);
```

```
    sf = updateSequence(sf,videoFrame);  
end
```

Classify the video sequence updated so far.

```
[label1, score1] = classifySequence(sf)
```

```
label1 = categorical  
        washing hands
```

```
score1 = single  
        0.0031
```

Display the classified label.

```
player = vision.VideoPlayer('Name','Washing Hands');  
for ii = sequenceRange  
    frame = read(reader,ii);  
    % Resize the frame by 1.5 times for display  
    frame = imresize(frame,1.5);  
    frame = insertText(frame,[2,2], string(label1),'FontSize',18);  
    step(player,frame);  
end
```

Washing Hands

File Tools View Playback Help

+ - Hand Full Screen



washing hands

Processing Magnification: 100% RGB:405x720 32

Classify Second Video Sequence

Reset the video sequence of the video classifier without creating a new video classifier.

```
sf = resetSequence(sf);
```

Specify another video file to classify.

```
videoFilename = "vipmen.avi";
```

Create a VideoReader to read the video frames.

```
reader = VideoReader(videoFilename);
```

Read a video sequence starting from the 131st frame, where the "shaking hands" action begins.

```
startSequenceIndex = 131;  
sequenceRange = [startSequenceIndex, startSequenceIndex + sequenceLength - 1];
```

Classify the second video sequence.

```
for ii = sequenceRange  
    videoFrame = read(reader,ii);  
    sf = updateSequence(sf,frame);  
end
```

```
[label2, score2] = classifySequence(sf)
```

```
label2 = categorical  
        shaking hands
```

```
score2 = single  
        0.0039
```

Display the classified label.

```
player = vision.VideoPlayer('Name','Shaking Hands');  
for ii = sequenceRange  
    frame = read(reader,ii);  
    % Resize the frame by 4 times for display  
    frame = imresize(frame, 4);  
    frame = insertText(frame,[2,2], string(label2),'FontSize',18);  
    step(player,frame);  
end
```

Shaking Hands

File Tools View Playback Help

+ - Hand [Zoom]



shaking hands

Processing Magnification: 100% RGB:480x640 32

Input Arguments

i3d – Classifier

inflated3dVideoClassifier object

Classifier, specified as an `inflated3dVideoClassifier` object.

Output Arguments

i3dReset – Reset video classifier

inflated3dVideoClassifier object

Reset video classifier, returned as an `inflated3dVideoClassifier` object.

See Also

Functions

`sceneTimeRanges` | `writeVideoScenes` | `classifyVideoFile` | `classifySequence` | `updateSequence` | `forward` | `predict`

Objects

`r2plus1dVideoClassifier` | `slowFastVideoClassifier` | `inflated3dVideoClassifier`

Topics

“Classify Streaming Webcam Video Using SlowFast Video Classifier”

Introduced in R2021b

updateSequence

Update video sequence for classification

Syntax

```
classifierUpdated = updateSequence(classifier,videoFrame)
classifierUpdated = updateSequence(classifier,videoFrame,
ExecutionEnvironment=env)
```

Description

`classifierUpdated = updateSequence(classifier,videoFrame)` updates the video sequence with the video frame `videoFrame`, and outputs an updated classifier. The output contains the updated classifier object.

To classify the updated sequence, use the `classifySequence` object function.

The video classifier object maintains the sequence as a first-in first-out (FIFO) queue. The `InputSize` property of the classifier object specifies the number of frames in the queue.

`classifierUpdated = updateSequence(classifier,videoFrame, ExecutionEnvironment=env)` specifies the hardware resources for running the classifier in addition to any combination of arguments from previous syntaxes, as one of these options:

- "auto" — Sets the execution environment to the GPU, if available. Otherwise the function sets it to the CPU.
- "gpu" — Sets the execution environment to the GPU. Usage of the GPU requires Parallel Computing Toolbox and a CUDA enabled NVIDIA GPU. For information about the supported compute capabilities, see "GPU Support by Release" (Parallel Computing Toolbox).
- "cpu" — Sets the execution environment to the CPU.

Examples

Classify Video Sequences in a Video File

This example shows how to classify video sequences in a video file using a SlowFast Video Classifier pretrained on the Kinetics-400 video activity recognition dataset. To learn more about how to train a video classifier network for your dataset, see "Gesture Recognition using Videos and Deep Learning".

Load SlowFast Video Classifier

```
sf = slowFastVideoClassifier();
```

Setup Video Player and Video Reader

Specify the video file name to stream video frames.

```
videoFilename = "pushup.mp4";
```

Create a VideoReader to read video.

```
reader = VideoReader(videoFilename);
```

Setup a video player.

```
player = vision.VideoPlayer;
```

Classify Video Sequences

Specify how frequently the classifier should be applied to incoming video frames.

```
classifyInterval = 10;
```

A value of 10 balances runtime performance against classification performance. Increase this value to improve runtime performance at the cost of missing actions from the video file.

Obtain the sequence length of the SlowFast Video Classifier. Classify only after capturing at least `sequenceLength` number of frames from the video file.

```
sequenceLength = sf.InputSize(4);
```

Read video frames using the `hasFrame` and `readFrame` functions of the `VideoReader`. Using the `updateSequence` function update the video classifier's sequence. Using the `classifySequence` function classify the updated sequence.

```
numFrames = 0;
```

```
text = "";
```

```
while hasFrame(reader)
```

```
    frame = readFrame(reader);
```

```
    numFrames = numFrames + 1;
```

```
    % Update the sequence with the next video frame.
```

```
    sf = updateSequence(sf,frame);
```

```
    % Classify the sequence only at every classifyInterval number of frames.
```

```
    if mod(numFrames, classifyInterval) == 0 && numFrames >= sequenceLength
```

```
        [label,score] = classifySequence(sf);
```

```
        text = string(label) + "; " + num2str(score, "%0.2f");
```

```
    end
```

```
    frame = insertText(frame,[30,30],text,'FontSize',24);
```

```
    step(player,frame);
```

```
end
```

Video Player

File Tools View Playback Help

+ - Hand Full Screen

push up; 0.01

Processing Magnification: 100% RGB:364x640 163

Input Arguments

classifier – Classifier object

r2plus1dVideoClassifier object | slowFastVideoClassifier object

Classifier object, specified as r2plus1dVideoClassifier or slowFastVideoClassifier object.

videoFrame – Video frame

numeric array

Video frame for updating the classifier, specified as an *H*-by-*W*-by-*C* numeric array. *H*, *W*, and *C* represent the height, width, and number of channels, respectively. The number of channels must match the number of channels set by the `InputSize` property of the classifier object.

Output Arguments

classifierUpdated — Updated video classifier

`r2plus1dVideoClassifier` object | `slowFastVideoClassifier` object

Updated video classifier, returned as a `r2plus1dVideoClassifier` or `slowFastVideoClassifier` object.

See Also

Objects

`inflated3dVideoClassifier` | `slowFastVideoClassifier` | `r2plus1dVideoClassifier`

Functions

`classifySequence` | `resetSequence` | `classifyVideoFile` | `forward` | `predict`

Topics

“Classify Streaming Webcam Video Using SlowFast Video Classifier”

Introduced in R2021b

updateSequence

Update video or optical flow sequence for classification

Syntax

```
i3dUpdated = updateSequence(i3d,videoFrame)
i3dUpdated = updateSequence(i3d,videoFrame,ExecutionEnvironment=env)
```

Description

`i3dUpdated = updateSequence(i3d,videoFrame)` updates the video or optical flow sequence with the video frame `videoFrame`, and outputs the updated Inflated-3D (I3D) video classifier `i3d` classifier. The output contains the updated classifier object.

To classify the updated sequence, use the `classifySequence` object function.

The video classifier object maintains the sequence as a first-in first-out (FIFO) queue. The `InputSize` property of the classifier object specifies the number of frames in the queue.

`i3dUpdated = updateSequence(i3d,videoFrame,ExecutionEnvironment=env)` specifies the hardware resources for running the classifier in addition to any combination of arguments from previous syntaxes, as one of these options:

- "auto" — Sets the execution environment to the GPU, if available. Otherwise the function sets it to the CPU.
- "gpu" — Sets the execution environment to the GPU. Usage of the GPU requires Parallel Computing Toolbox and a CUDA enabled NVIDIA GPU. For information about the supported compute capabilities, see "GPU Support by Release" (Parallel Computing Toolbox).
- "cpu" — Sets the execution environment to the CPU.

Examples

Classify Video Sequences in a Video File

This example shows how to classify video sequences in a video file using a SlowFast Video Classifier pretrained on the Kinetics-400 video activity recognition dataset. To learn more about how to train a video classifier network for your dataset, see "Gesture Recognition using Videos and Deep Learning".

Load SlowFast Video Classifier

```
sf = slowFastVideoClassifier();
```

Setup Video Player and Video Reader

Specify the video file name to stream video frames.

```
videoFilename = "pushup.mp4";
```

Create a VideoReader to read video.

```
reader = VideoReader(videoFilename);
```

Setup a video player.

```
player = vision.VideoPlayer;
```

Classify Video Sequences

Specify how frequently the classifier should be applied to incoming video frames.

```
classifyInterval = 10;
```

A value of 10 balances runtime performance against classification performance. Increase this value to improve runtime performance at the cost of missing actions from the video file.

Obtain the sequence length of the SlowFast Video Classifier. Classify only after capturing at least `sequenceLength` number of frames from the video file.

```
sequenceLength = sf.InputSize(4);
```

Read video frames using the `hasFrame` and `readFrame` functions of the `VideoReader`. Using the `updateSequence` function update the video classifier's sequence. Using the `classifySequence` function classify the updated sequence.

```
numFrames = 0;
```

```
text = "";
```

```
while hasFrame(reader)
    frame = readFrame(reader);
    numFrames = numFrames + 1;

    % Update the sequence with the next video frame.
    sf = updateSequence(sf,frame);

    % Classify the sequence only at every classifyInterval number of frames.
    if mod(numFrames, classifyInterval) == 0 && numFrames >= sequenceLength
        [label,score] = classifySequence(sf);
        text = string(label) + "; " + num2str(score, "%0.2f");
    end
    frame = insertText(frame,[30,30],text,'FontSize',24);
    step(player,frame);
end
```

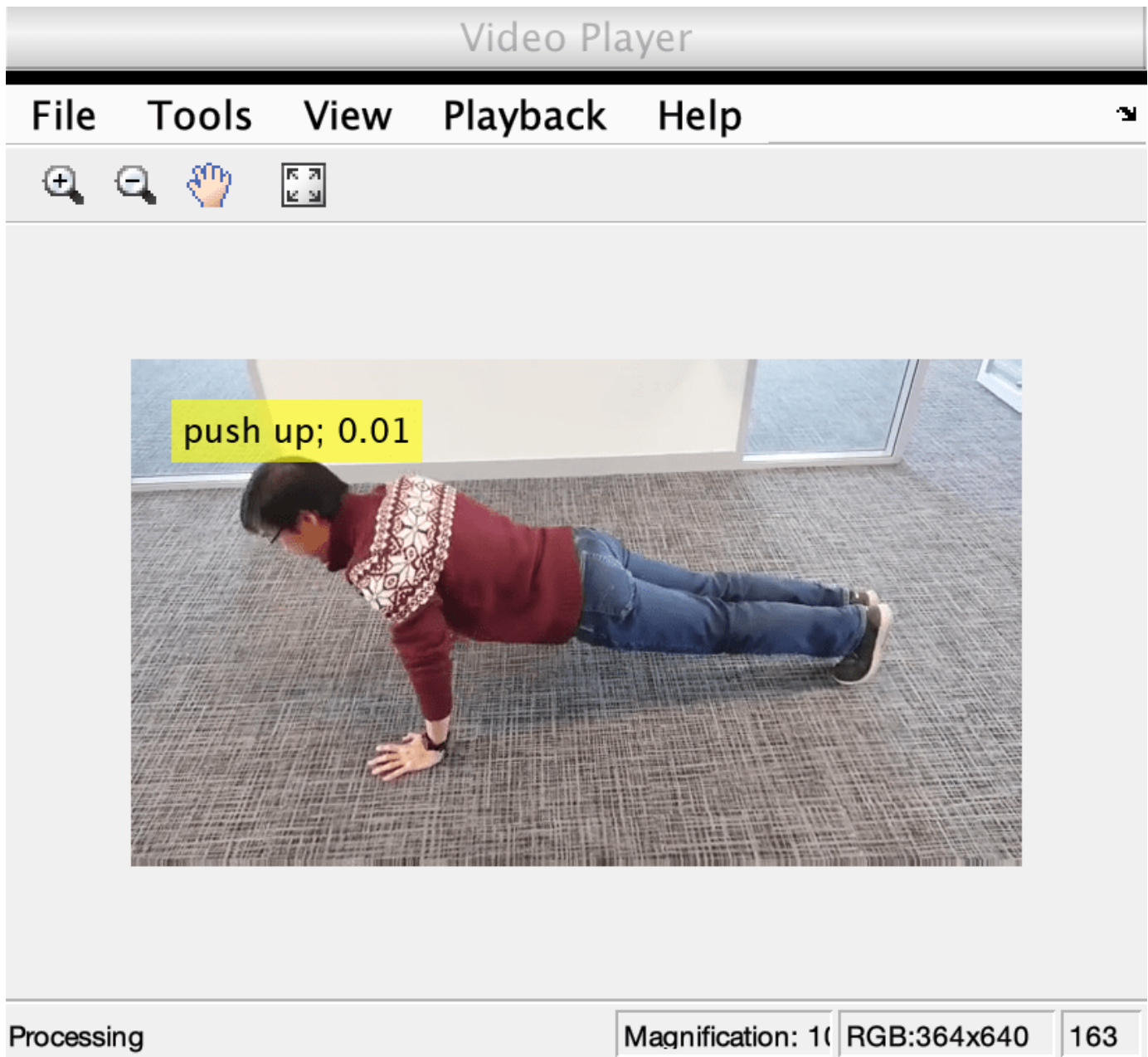

Input Arguments

i3d – Classifier

`inflated3dVideoClassifier` object

Classifier, specified as an `inflated3dVideoClassifier` object.

videoFrame – Video frame

numeric array

Video frame for updating the classifier, specified as an *H*-by-*W*-by-*C* numeric array. *H*, *W*, and *C* represent the height, width, and number of channels, respectively. The number of channels must match the number of channels set by the `InputSize` property of the classifier object.

Output Arguments

i3dUpdated – Updated video classifier

`inflated3dVideoClassifier` object

Updated video classifier, returned as an `inflated3dVideoClassifier` object.

See Also

Objects

`inflated3dVideoClassifier` | `slowFastVideoClassifier` | `r2plus1dVideoClassifier`

Functions

`classifyVideoFile` | `forward` | `predict` | `resetSequence` | `classifySequence`

Introduced in R2021b

vision.calibration.PatternDetector class

Package: vision.calibration

Interface for defining custom planar pattern detectors

Description

The `vision.calibration.PatternDetector` class specifies the interface for defining custom planar pattern detectors for the **Camera Calibrator** and **Stereo Camera Calibrator** apps, as well as on the MATLAB command line.

To define a custom pattern detector, you must construct a class that inherits from the `vision.OpenPatternDetectorTemplate` class. This is an abstract class that defines the methods and properties for detecting calibration pattern keypoints in the images, invoked during the calibration process, and to generate corresponding points in the world coordinates.

You can define a custom pattern detector for single camera calibration, starting with a template, by typing this command at the MATLAB prompt:

```
vision.OpenPatternDetectorTemplate('monocular')
```

You can define a custom pattern detector for stereo camera calibration, starting with a template, by typing the following at the MATLAB prompt:

```
vision.calibration.PatternDetector.createDetectorTemplate('stereo')
```

The `vision.calibration.PatternDetector` class is a handle class.

Class Attributes

Abstract true

For information on class attributes, see “Class Attributes”.

Properties

Clients of the `PatternDetector` class specify these predefined properties.

Name — Pattern detector name

character vector | string scalar

Pattern detector name, specified as a character vector or a string scalar.

WorldUnits — World point units

character vector | string scalar

World point units, specified as a character vector or a string scalar. `WorldUnits` specifies the unit of measure for the pattern keypoints in world coordinates.

panel — Properties panel user-defined UI components

uipanel object

Properties panel user-defined UI components for displaying and specifying detector properties, specified as a `uiPanel` object. To set this property, use the `propertiesPanel` function with a `uiPanel` object, which the `PatternDetector` invokes.

Methods

Public Methods

Clients of a `PatternDetector` implement these user-defined functions to define execution of the algorithm. For more information on creating a custom detection pattern, see “Camera Calibration Using AprilTag Markers”.

<code>generateWorldPoints</code>	Generate world coordinates for planar pattern keypoints
<code>propertiesPanel</code>	Define properties panel for custom pattern detector
<code>drawImageAxesLabels</code>	Display location and orientation of axes labels
<code>detectPatternPoints</code>	Detect calibration pattern keypoints in images

See Also

Apps

Camera Calibrator | **Stereo Camera Calibrator**

Functions

`generateCircleGridPoints` | `detectCircleGridPoints` | `estimateCameraParameters` | `detectCheckerboardPoints` | `generateCheckerboardPoints`

Objects

`cameraParameters` | `stereoParameters`

Topics

“Camera Calibration Using AprilTag Markers”

Introduced in R2021b

propertiesPanel

Package: vision.calibration

Define properties panel for custom pattern detector

Syntax

```
propertiesPanel(detectorObj,panel)
```

Description

`propertiesPanel(detectorObj,panel)` displays properties contained in the detector object `detectorObj` in the parent user interface (UI) panel `panel`.

The **Camera Calibrator** or the **Stereo Camera Calibrator** app invokes the `propertiesPanel` object function when you select a custom pattern from one of the available patterns. Use this object function to define UI elements in the **Properties** section of the Image and Pattern Properties dialog box of the **Camera Calibrator** or the **Load Stereo Images** dialog box of the **Stereo Camera Calibrator** app.

Examples

Custom Pattern Properties Panel for Camera Calibrator

The `propertiesPanel` function enables you to customize the properties panel of a calibrator app by creating UI elements and defining their behavior. This `propertiesPanel` code snippet creates a properties panel related to a checkerboard detection:

```
function propertiesPanel(this,panel)
%-----
% UI components for square size selector
%-----
    this.Panel = panel;

% Label
    position = [90, 40, 185, 20];
    labelText = 'Square Size (in millimeters): ';
    uicontrol('Parent',this.Panel,'Style','text','FontUnits', ...
        'pixels',FontSize, 12,'Position',position, ...
        'HorizontalAlignment','left','String',labelText);

% Editbox
    position = [275, 37, 50, 25];
    initSquareSize = 25;
    squareSizeEditBox = uicontrol('Parent',this.Panel, ...
        'Style','edit','FontUnits','pixels','FontSize',15, ...
        'String',initSquareSize,'Position', position, ...
        'Callback',@(~, ~) doSquareSizeChanged(this));

% Initialize property values
```

```

        this.SquareSize = str2double(get(squareSizeEditBox, 'String'));
    end

%-----
function doSquareSizeChanged(this)
    this.SquareSize = str2double(get(this.SquareSizeEditBox, 'String'));

    if this.SquareSize <= 0 || isnan(this.SquareSize)
        errordlg('Square size must be a numeric value greater than zero.');
```

This function produces this UI pane:

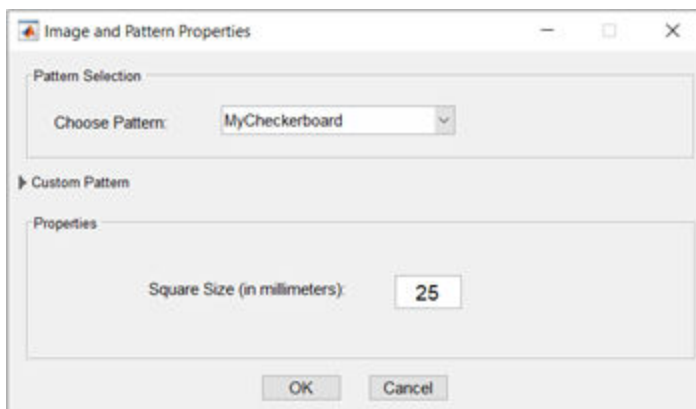

Input Arguments

detectorObj – Detector object

`vision.calibration.PatternDetector` object

Detector object, specified as a single or stereo `vision.calibration.PatternDetector` object.

panel – User-defined UI components

`uipanel` object

User-defined UI components for displaying and specifying detector properties, specified as a `uipanel` object. When you invoke the `propertiesPanel` function with a `uipanel` object.

See Also

Apps

[Camera Calibrator](#) | [Stereo Camera Calibrator](#)

Functions

[generateWorldPoints](#) | [drawImageAxesLabels](#) | [detectPatternPoints](#)

Objects

`vision.calibration.PatternDetector`

Topics

“Camera Calibration Using AprilTag Markers”

Introduced in R2021b

drawImageAxesLabels

Package: vision.calibration

Display location and orientation of axes labels

Syntax

```
[originLabel,xLabel,yLabel] = drawImageAxesLabels(detectorObj,imagePoints)
```

Description

`[originLabel,xLabel,yLabel] = drawImageAxesLabels(detectorObj,imagePoints)` displays the orientation and location of the origin `originLabel` and the X- and Y-axis labels `xLabel` and `yLabel` of the circle grid pattern detected in the images rendered in the **Camera Calibrator** and **Stereo Camera Calibrator** apps.

If you do not implement this function, or if the returned values are empty, then the function does not render origin or axes labels in the image.

Examples

Label Image in Calibrator App

Use the `drawImageAxesLabels` function to identify and label the orientation and location for the origin and the X- and Y-axis labels of a detected pattern grid in an image. For example:

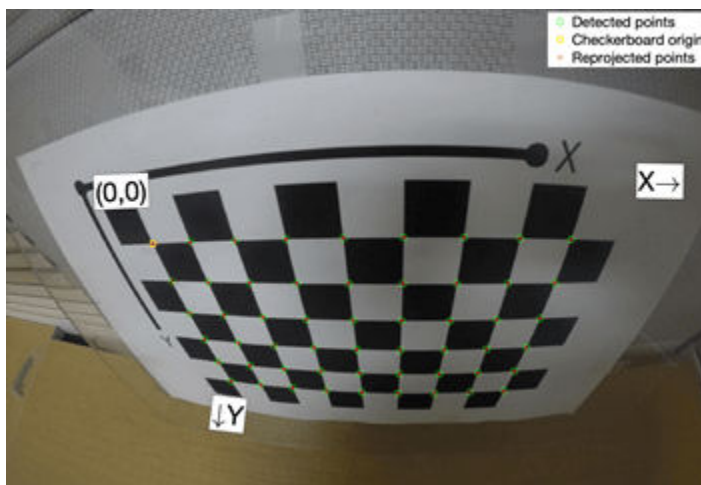

Calculate Orientation and Location for Pattern Origin

Use this function template, which includes the use of the `drawImageAxesLabels` object function, to calculate the orientation and location of the origin of the detected calibration pattern in an image.

The function omits the X- and Y-labels. The function includes both programmatic and app workflows for detecting the points.

```
function [originLabel,xLabel,yLabel] = drawImageAxesLabels(this,imagePoints)

    numBoardRows = this.BoardSize(1) - 1;
    numBoardCols = this.BoardSize(2) - 1;

    % Reshape checkerboard corners to boardSize-shaped array
    boardCoordsX = reshape(imagePoints(:,1),[numBoardRows numBoardCols]);
    boardCoordsY = reshape(imagePoints(:,2),[numBoardRows numBoardCols]);
    boardCoords = cat(3,boardCoordsX,boardCoordsY);

    % Origin label (check if the origin location is inside the image)
    if ~isnan(boardCoords(1,1))
        p1 = boardCoords(1,1,:);

        refPointIdx = find(~isnan(boardCoords(:,1)),2);
        p2 = boardCoords(refPointIdx(2),1,:);

        refPointIdx = find(~isnan(boardCoords(1,:)),2);
        p3 = boardCoords(1,refPointIdx(2),:);

        [loc, theta] = getAxesLabelPosition(p1,p2,p3);

        originLabel.Location = loc;
        originLabel.Orientation = theta;
    else
        originLabel = struct;
    end

    % X-axis and Y-axis labels
    xLabel = struct('Orientation',[],'Location',[]);
    yLabel = struct('Orientation',[],'Location',[]);

    %-----
    % p1+v
    % \
    % \      v1
    %  p1 ----- p2
    %  |
    % v2 |
    %  |
    %  p3
    function [loc, theta] = getAxesLabelPosition(p1,p2,p3)
        v1 = p3 - p1;
        theta = -atan2d(v1(2),v1(1));

        v2 = p2 - p1;
        v = -v1 - v2;
        d = hypot(v(1),v(2));
        minDist = 40;
        if d < minDist
            v = (v/d) * minDist;
        end
        loc = p1 + v;
    end
end
```

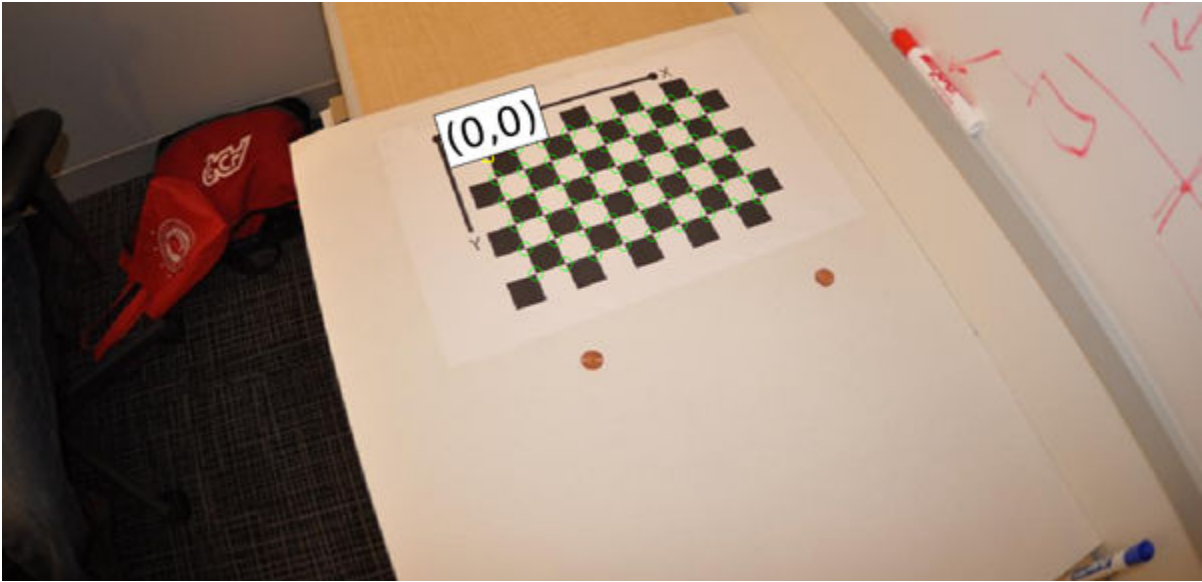

Input Arguments

detectorObj — Detector object

`vision.calibration.PatternDetector` object

Detector object, specified as a single or stereo `vision.calibration.PatternDetector` object.

imagePoints — Image coordinates of detected circle grid

M-by-2 array

Image coordinates of the detected circle grid, returned as an *M*-by-2 array of *x,y* coordinates.

Output Arguments

originLabel — Orientation and location for pattern origin label

structure

Orientation and location of the pattern origin label, returned as a structure with two fields. The **Orientation** field contains the rotation of the origin label in the image frame, specified in degrees. The **Location** field contains the *x,y* location of the origin label in the image frame.

xLabel — Orientation and location of X-axis label

structure

Orientation and location of the X-axis label, returned as a structure with two fields. The **Orientation** field contains the rotation of the axis label in the image frame, specified in degrees. The **Location** field contains the *x,y* location of the axis label in the image frame.

yLabel — Orientation and location for Y- axis label

structure

Orientation and location of the Y-axis label, returned as a structure with two fields. The **Orientation** field contains the rotation of the axis label in the image frame, specified in degrees. The **Location** field contains the *x,y* location of the axis label in the image frame.

See Also

Apps

Camera Calibrator | Stereo Camera Calibrator

Functions

generateWorldPoints | propertiesPanel | detectPatternPoints

Objects

cameraParameters | stereoParameters | vision.calibration.PatternDetector

Topics

“Camera Calibration Using AprilTag Markers”

Introduced in R2021b

generateWorldPoints

Package: vision.calibration

Generate world coordinates for planar pattern keypoints

Syntax

```
worldPoints = generateWorldPoints(detectorObj)
worldPoints = generateWorldPoints(detectorObj,varargin)
```

Description

`worldPoints = generateWorldPoints(detectorObj)` generates world coordinates for the detected keypoints of the calibration pattern.

`worldPoints = generateWorldPoints(detectorObj,varargin)` uses the `varargin` input to parse any additional parameters or options necessary to generate world points. For example, you can provide the parameters or options obtained from the properties pane of your calibrator app.

Examples

Generate World Points for Checkerboard Pattern

Use this function template, which includes the use of the `generateCheckerboardPoints` object function, to generate world points for a checkerboard pattern generator. The function includes both programmatic and app workflows for generating the world (image) points. The function uses name-value arguments for board and square size to set the corresponding fields in the **Properties** pane of the calibrator app.

```
function worldPoints = generateWorldPoints(this,varargin)

    if nargin > 1 % Command Line workflow
        parser = inputParser;
        parser.AddParameter('SquareSize',25,@checkSquareSize);
        parser.AddParameter('BoardSize',this.BoardSize,@checkBoardSize);
        parser.parse(varargin{:});

        boardSize = parser.Results.BoardSize;
        squareSize = parser.Results.SquareSize;
    else % Calibrator App workflow
        boardSize = this.BoardSize;
        squareSize = this.SquareSize;
    end

    worldPoints = generateCheckerboardPoints(boardSize,squareSize);

    %-----
    % Validation functions for command line workflow
    %-----
    function tf = checkSquareSize(squareSize)
```



```

        validateattributes(squareSize, {'numeric'}, ...
            {'scalar', 'positive', 'finite', 'nonsparse'}, mfilename, 'SquareSize');
        tf = true;
    end

%-----
function tf = checkBoardSize(boardSize)
    validateattributes(boardSize, {'numeric'}, ...
        {'nonempty', 'vector', 'numel', 2, 'integer', 'positive', '>=', 3}, ...
        mfilename, 'BoardSize');
    tf = true;
end
end

```

Input Arguments

detectorObj – Pattern detector

vision.calibration.PatternDetector object.

Pattern detector, specified as a single or stereo vision.calibration.PatternDetector object.

varargin – Variable number of inputs

1-by- N cell array

Variable number of inputs, specified as a 1-by- N cell array, where N is the number of inputs to the function after detectorObj. For more details about using this input, see varargin.

Output Arguments

worldPoints – Image coordinates of detected key points

M -by-2 array

Image coordinates of detected keypoints in the calibration pattern, returned as an M -by-2 array of x,y coordinates. M is the number of pattern keypoints detected in the calibration images by using the detectPatternPoints function.

See Also

Apps

Camera Calibrator | Stereo Camera Calibrator

Functions

generateCircleGridPoints | detectPatternPoints | detectCheckerboardPoints | propertiesPanel | drawImageAxesLabels | detectPatternPoints

Objects

cameraParameters | stereoParameters | vision.calibration.PatternDetector

Topics

“Camera Calibration Using AprilTag Markers”

Introduced in R2021b

detectPatternPoints

Package: vision.calibration

Detect calibration pattern keypoints in images

Syntax

```
[imagePoints,imagesUsed] = detectPatternPoints(detectorObj,imageFileNames)
[imagePoints,pairsUsed] = detectPatternPoints(detectorObj,imageFileNames1,
imageFileNames2)
```

```
[ ___ ] = detectPatternPoints( ___ ,varargin)
```

Description

`[imagePoints,imagesUsed] = detectPatternPoints(detectorObj,imageFileNames)` detects the calibration pattern keypoints in the image files, specified by `imageFileNames`. The function also indicates in which of the images it detects the calibration pattern.

`[imagePoints,pairsUsed] = detectPatternPoints(detectorObj,imageFileNames1,imageFileNames2)` detects the calibration pattern keypoints in the stereo pairs of image files specified in `imageFileNames1` and `imageFileNames2`. The function also indicates in which of the image pairs it detects the calibration pattern.

`[___] = detectPatternPoints(___ ,varargin)` parses any parameters or options needed for detection . For example, you can provide the parameters or options obtained from the properties panel of your calibrator app while using it from the command line.

Examples

Detect Pattern Points for a Checkerboard Pattern

Use this function template, which includes the use of the `detectPatternPoints` object function, to detect the keypoints of a calibration pattern. The function includes both programmatic and app workflows for detecting the points.

```
function [imagePoints,imagesUsed] = detectPatternPoints(this,imageFileNames,varargin)
    parser = inputParser;
    parser.AddParameter('HighDistortion',false,@checkHighDistortion);
    parser.parse(varargin{:});
    highDistortion = parser.Results.HighDistortion;

    % Use 'IsDistortionHigh' member value when the default value is
    % being used for HighDistortion
    if ismember('HighDistortion',parser.UsingDefaults)
        highDistortion = this.IsDistortionHigh;
    end

    [imagePoints,boardSize,imagesUsed] = detectCheckerboardPoints( ...
        imageFileNames,HighDistortion=highDistortion);
```

```

this.BoardSize = boardSize;

%-----
function tf = checkHighDistortion(highDistortion)
    validateattributes(highDistortion,{'logical','numeric'}, ...
        {'scalar','binary'},mfilename,'HighDistortion');
    tf = true;
end
end

```

Input Arguments

detectorObj — Detector object

vision.calibration.PatternDetector object

Detector object, specified as a single or stereo vision.calibration.PatternDetector object.

imageFileNames — Image file names

cell array of character vectors | vector of strings

Image file names, specified as a cell array of character vectors or a vector of strings.

imageFileNames1 — Stereo image file names for camera one

cell array of character vectors | array of string vectors

Stereo image file names for camera one, specified as a cell array of character vectors or an array of strings.

imageFileNames2 — Stereo image file names for camera two

cell array of character vectors | array of string vectors

Stereo image file names for camera two, specified as a cell array of character vectors or an array of strings.

varargin — Variable number of inputs

1-by- N cell array

Variable number of inputs, specified as a 1-by- N cell array, where N is the number of inputs to the function receives after the explicitly declared inputs. For more details about using this input, see varargin.

Output Arguments

imagePoints — Image coordinates of detected pattern keypoints

M -by-2- by- $numImages$ | M -by-2-by- $numPairs$ -by-2 array

Image x-y coordinates of detected pattern keypoints, returned as an M -by-2-by- $numImages$ array for single camera calibration or an M -by-2-by- $numPairs$ -by-2 array for stereo camera calibration. $numImages$ is the number of images in which a circle grid is detected. $numPairs$ is the number of image pairs in which a circle grid is detected. For stereo images, `imagePoints(:, :, :, 1)` returns the pattern keypoints from the first set of images, and `imagePoints(:, :, :, 2)` returns the pattern keypoints from the second set of images. If the function cannot detect the complete pattern, then it returns a partially detected pattern with [NaN, NaN] for those x-y coordinates that could not be detected.

imagesUsed — Pattern detection flag

logical vector

Pattern detection flag, returned as a logical vector. A value of `true` for an element of the `imagesUsed` vector indicates that the function has detected the pattern in the corresponding image.

pairsUsed — Stereo pair pattern detection flag

logical vector

Stereo pair pattern detection flag, returned as a logical vector. A value of `true` for an element of the `pairsUsed` vector indicates that the function has detected the pattern in the corresponding image pair.

See Also**Apps**[Camera Calibrator](#) | [Stereo Camera Calibrator](#)**Functions**[estimateCameraParameters](#) | [detectCheckerboardPoints](#) | [generateWorldPoints](#) | [propertiesPanel](#) | [detectCircleGridPoints](#) | [readAprilTag](#)**Objects**[cameraParameters](#) | [stereoParameters](#) | [vision.calibration.PatternDetector](#)**Topics**[“Camera Calibration Using AprilTag Markers”](#)**Introduced in R2021b**

scanContextLoopDetector

Detect loop closures using scan context descriptors

Description

`scanContextLoopDetector` detects loop closures in point cloud data using global scan context descriptors. A scan context descriptor encodes a point cloud view into a 2-D descriptor. `scanContextLoopDetector` stores the descriptors with a corresponding view identifier to associate the detected loop closures to a view in a `pcviewset` for map building.

Creation

Syntax

```
loopDetector = scanContextLoopDetector()
```

Description

`loopDetector = scanContextLoopDetector()` creates a default `scanContextLoopDetector` object. Use the `addDescriptor` object function to add descriptors to the loop detector. Use the `detectLoop` object function to detect loop closures.

Properties

ViewIds – View identifiers

P-element vector

This property is read-only.

View identifiers, specified as a *P*-element vector of unique positive integers, where *P* is the number of descriptors added to the detector.

Descriptors – Scan context descriptors

M-by-*N*-by-*P* array

This property is read-only.

Scan context descriptors, specified as an *M*-by-*N*-by-*P* array. *M* is the number of radial bins and *N* is the number of azimuthal bins in the descriptor. *P* is the number of descriptors in the detector.

Object Functions

<code>addDescriptor</code>	Add descriptor to the loop closure detector
<code>deleteDescriptor</code>	Delete descriptors from the loop closure detector
<code>detectLoop</code>	Detect loop closures

Examples

Detect Loop Closure Against Recently Added Descriptor

Create a loop closure detector.

```
loopDetector = scanContextLoopDetector;
```

Create a Velodyne PCAP file reader.

```
veloReader = velodyneFileReader('lidarData_ConstructionRoad.pcap','HDL32E');
```

Read the point clouds and extract the scan context descriptor from each point cloud scan. Add the descriptors to the detector.

```
for viewId = 1:10
    ptCloud = readFrame(veloReader,viewId);
    descriptor = scanContextDescriptor(ptCloud);
    addDescriptor(loopDetector,viewId,descriptor);
end
```

Check if the next point cloud can be classified as a loop closure detection without excluding any recently added descriptors.

```
viewId = viewId + 1;
ptCloud = readFrame(veloReader,viewId);
descriptor = scanContextDescriptor(ptCloud);
[loopViewId,dists] = detectLoop(loopDetector,descriptor,'NumExcludedDescriptors',0)

loopViewId = uint32
    10

dists = single
    0.0831
```

See Also

Objects

pointCloud | pcviewset | pemapndt

Functions

scanContextDescriptor | scanContextDistance | pcregisterndt

Topics

“Implement Point Cloud SLAM in MATLAB”

“Build a Map from Lidar Data Using SLAM”

Introduced in R2021b

addDescriptor

Add descriptor to the loop closure detector

Syntax

```
addDescriptor(loopDetector,viewID,descriptor)
```

Description

`addDescriptor(loopDetector,viewID,descriptor)` adds the scan context descriptor that corresponds to the view identifier `viewID` to the loop closure detector `loopDetector`.

Compute descriptors to add to the loop closure detector over the same radial range, with the same number of radial and azimuthal bins. Use the `viewID` input to associate descriptors with a view in `pcviewset`.

Examples

Add Descriptor to Loop Closure Detector

Create a loop closure detector.

```
loopDetector = scanContextLoopDetector;
```

Load point cloud data into the workspace.

```
data = load("drivingLidarPoints.mat");  
ptCloud = data.ptCloud;
```

Extract a scan context descriptor from the point cloud data.

```
descriptor = scanContextDescriptor(ptCloud);
```

Add the descriptor to the loop closure detector.

```
viewId = 1;  
addDescriptor(loopDetector,viewId,descriptor);
```

Input Arguments

loopDetector — Loop closure detector

`scanContextLoopDetector` object

Loop closure detector, specified as a `scanContextLoopDetector` object.

viewID — View identifier

positive integer

View identifier, specified as a positive integer. You can use the same `viewID` to associate descriptors with a view in a `pcviewset`.

descriptor — Scan context descriptor

M-by-*N* matrix

Scan context descriptor, specified as an *M*-by-*N* matrix, where *M* is the number of radial bins and *N* is the number of azimuthal bins.

See Also**Objects**

`pointCloud` | `scanContextLoopDetector`

Functions

`scanContextDescriptor` | `scanContextDistance` | `detectLoop` | `deleteDescriptor`

Topics

“Implement Point Cloud SLAM in MATLAB”

“Build a Map from Lidar Data Using SLAM”

Introduced in R2021b

deleteDescriptor

Delete descriptors from the loop closure detector

Syntax

```
deleteDescriptor(loopDetector,viewIDs)
```

Description

`deleteDescriptor(loopDetector,viewIDs)` deletes the descriptors that correspond to the view identifiers `viewIDs` from the loop closure detector `loopDetector`. `viewIDs` is a vector of positive integers.

Examples

Delete Descriptor From Loop Closure Detector

Create a loop closure detector.

```
loopDetector = scanContextLoopDetector;
```

Create a Velodyne PCAP file reader.

```
veloReader = velodyneFileReader('lidarData_ConstructionRoad.pcap','HDL32E');
```

Read the first and second point cloud scans.

```
ptCloud1 = readFrame(veloReader,1);  
ptCloud2 = readFrame(veloReader,2);
```

Extract the descriptor for the first point cloud and add it to the loop closure detector.

```
viewId1 = 1;  
descriptor1 = scanContextDescriptor(ptCloud1);  
addDescriptor(loopDetector,viewId1,descriptor1);
```

Extract the second descriptor and add it to the loop closure detector.

```
viewId2 = 2;  
descriptor2 = scanContextDescriptor(ptCloud2);  
addDescriptor(loopDetector,viewId2,descriptor2);
```

Delete the descriptor that corresponds to view identifier 2, from the detector.

```
deleteDescriptor(loopDetector,viewId2);
```

Input Arguments

loopDetector — Loop closure detector

`scanContextLoopDetector` object

Loop closure detector, specified as a `scanContextLoopDetector` object.

viewIDs — View identifiers

vector of integers

View identifiers, specified as a vector of positive integers.

See Also

Objects

`pointCloud` | `scanContextLoopDetector`

Functions

`scanContextDescriptor` | `addDescriptor` | `detectLoop`

Topics

“Implement Point Cloud SLAM in MATLAB”

Introduced in R2021b

detectLoop

Detect loop closures

Syntax

```
loopViewIds = detectLoop(loopDetector)
loopViewIds = detectLoop(loopDetector,descriptor)
[loopViewIds,dists] = detectLoop( ___ )
[ ___ ] = detectLoop( ___ ,Name=Value)
```

Description

`loopViewIds = detectLoop(loopDetector)` detects loop closures for the last added descriptor and returns the view identifiers `loopViewIds` that correspond to loop closures. If the function detects no loop closures, `loopViewIds` is empty. The loop closure detector ignores the number of most recently added descriptors, set by the `NumExcludedDescriptors` name-value argument, to avoid detecting loop closures against recent descriptors.

`loopViewIds = detectLoop(loopDetector,descriptor)` detects loop closures using the scan context descriptor `descriptor`.

`[loopViewIds,dists] = detectLoop(___)` returns the scan context distances `dists` between the loop descriptor and the query descriptors, using any combination of input arguments from previous syntaxes. The function computes distance between scan context descriptors, normalized to the range [0,1], using a modified cosine distance.

`[___] = detectLoop(___ ,Name=Value)` specifies options using one or more name-value arguments in addition to any combination of arguments from the previous syntaxes. For example, `detectLoop(loopDetector,NumExcludedDescriptors=15)` detects loop closures for the last added descriptor while ignoring only the 15 most recently added loop descriptors.

Examples

Detect Loop Closure Against Recently Added Descriptor

Create a loop closure detector.

```
loopDetector = scanContextLoopDetector;
```

Create a Velodyne PCAP file reader.

```
veloReader = velodyneFileReader('lidarData_ConstructionRoad.pcap','HDL32E');
```

Read the point clouds and extract the scan context descriptor from each point cloud scan. Add the descriptors to the detector.

```
for viewId = 1:10
    ptCloud = readFrame(veloReader,viewId);
    descriptor = scanContextDescriptor(ptCloud);
```

```

    addDescriptor(loopDetector,viewId,descriptor);
end

```

Check if the next point cloud can be classified as a loop closure detection without excluding any recently added descriptors.

```

viewId = viewId + 1;
ptCloud = readFrame(veloReader,viewId);
descriptor = scanContextDescriptor(ptCloud);
[loopViewId,dists] = detectLoop(loopDetector,descriptor,'NumExcludedDescriptors',0)

loopViewId = uint32
    10

dists = single
    0.0831

```

Input Arguments

loopDetector — Loop closure detector

scanContextLoopDetector object

Loop closure detector, specified as a scanContextLoopDetector object.

descriptor — Scan context descriptor

M -by- N matrix

Scan context descriptor, specified as an M -by- N matrix, where M is the number of radial bins and N is the number of azimuthal bins.

Name-Value Pair Arguments

Specify optional pairs of arguments as `Name1=Value1, ..., NameN=ValueN`, where `Name` is the argument name and `Value` is the corresponding value. Name-value arguments must appear after other arguments, but the order of the pairs does not matter.

Example: `detectLoop(loopDetector,NumExcludedDescriptors=15)` detects loop closures for the last added descriptor while ignoring only the 15 most recently added loop descriptors.

DistanceThreshold — Scan context distance threshold

0.1 (default) | positive scalar

Scan distance threshold to classify a view as a loop closure, specified as a positive scalar. Increasing this value can return more loop closures, but this can also increase false positives.

NumExcludedDescriptors — Number of most recently added descriptors to exclude

30 (default) | nonnegative integer

Number of most recently added descriptors to exclude as loop closure candidates, specified as a nonnegative integer. Exclude the most recently added descriptors to avoid detecting loop closures for the most recently added descriptor against recent descriptors. Increase `NumExcludedDescriptors` if many consecutive descriptors correspond to the same area.

SearchRadius — Search radius

0.3 (default) | positive scalar

Search radius in a subdescriptor space, specified as a positive scalar. The function computes the scan context distance for only those descriptors within the search radius. Increasing this value can return more loop closures, but can also increase false positives. Typical values range between 0.2 and 0.4.

MaxDetections — Maximum number of strongest loop closure detections returned

3 (default) | positive integer

Maximum number of strongest loop closure detections returned, specified as a positive integer. Increase this value to increase the potential number of loop closure detections returned. However, increasing this value can decrease computation speed. Set this value to `Inf` to return all loop closure detections.

Output Arguments

loopViewIds — Loop closure view identifiers

P-element vector

Loop closure view identifiers corresponding to loop closures, returned as a *P*-element vector of integer values. If the function finds no loop closures, it returns `loopViewIds` as an empty vector. The loop closure detector ignores the last “NumExcludedDescriptors” on page 2-0 descriptors to avoid detecting loop closures against recent descriptors.

dists — Scan context distance

P-element vector

Scan context distances, returned as a *P*-element vector of positive values. The distances represent the scan context distance between the loop descriptor and the corresponding query descriptor. The function computes the distance between scan context descriptors, normalized to the range [0,1], using a modified cosine distance.

Algorithms

The ring key descriptor is a subdescriptor extracted from a scan context descriptor. It is the occupancy ratio of each azimuthal bin that makes it rotation-invariant.

The scan context loop closure detector is a two-phase algorithm. It first uses the ring key descriptor for a nearest neighbor search to find candidate loop closures. Then, it computes the scan context distance using the scan context descriptors, and thresholds it to identify the best loop closure detections.

See Also

Objects

`pointCloud` | `scanContextLoopDetector` | `pcviewset`

Functions

`scanContextDescriptor` | `addDescriptor` | `deleteDescriptor` | `scanContextDistance`

Topics

“Implement Point Cloud SLAM in MATLAB”

“Build a Map from Lidar Data Using SLAM”

Introduced in R2021b

SIFTPoints

Object for storing SIFT interest points

Description

The SIFTPoints object enables you to pass data between the `detectSIFTFeatures` and `extractFeatures` functions. You can also use it to manipulate and plot the data returned by these functions. You can use the object to fill interest points interactively.

Creation

Syntax

```
points = SIFTPoints(location)
points = SIFTPoints(location,Name=Value)
```

Description

`points = SIFTPoints(location)` constructs a SIFTPoints object from an M -by-2 matrix of $[x\ y]$ point coordinates in `location`.

`points = SIFTPoints(location,Name=Value)` sets properties using one or more name-value arguments. For example, `SIFTPoints(Metric=0.0)`

Input Arguments

location — Point coordinates

M -by-2 matrix of $[x\ y]$ point coordinates.

Point coordinates, specified as an M -by-2 matrix of $[x\ y]$ point coordinates. M is the number of points.

Properties

Scale — Scale

1.6 (default) | scalar

Scale at which the interest points are detected, specified as a value greater than 0.

Metric — Strength of detected feature

0.0 (default) | numeric scalar

Strength of the detected feature, specified as a value in the range $[0\ 1]$. The SIFT algorithm uses the contrast threshold to determine strong features.

Orientation — Orientation

0.0 (default) | angle in radians

Orientation of the detected feature, specified as an angle, in radians. The angle is measured counterclockwise from the X -axis with the origin specified by the `location` input. Do not set this

property manually. Instead, use the call to `extractFeatures` to fill in this value. The `extractFeatures` function modifies the default value of `0.0`. The `Orientation` is mainly useful for visualization purposes.

Octave — Index of the Gaussian pyramid octave layer

0 (default) | non-negative integer

Index of the Gaussian pyramid octave layer that the keypoint is extracted from, specified as an integer. An octave is a collection of difference-of-Gaussian pyramid layers, and is used for scale-space.

Layer — Layer within the octave

0 (default) | integer

Layer within the octave from which the keypoint was extracted, specified as an integer.

Object Functions

<code>plot</code>	Plot points
<code>isempty</code>	Determine if points object is empty
<code>length</code>	Number of stored points
<code>selectStrongest</code>	Select points with strongest metrics
<code>size</code>	Return size of points object
<code>selectUniform</code>	Select uniformly distributed subset of feature points

Examples**Detect SIFT Features in Image**

Read an image.

```
I = imread("cameraman.tif");
```

Detect SIFT features in the image.

```
points = detectSIFTFeatures(I)
```

```
points =  
 274x1 SIFTPoints array with properties:
```

```
    Scale: [274x1 single]  
Orientation: [274x1 single]  
   Octave: [274x1 int32]  
    Layer: [274x1 int32]  
Location: [274x2 single]  
   Metric: [274x1 single]  
   Count: 274
```

Display the location and scale of the 10 strongest points in the image.

```
strongest = points.selectStrongest(10);  
imshow(I)  
hold on  
plot(strongest)
```



Display the [x y] coordinates for the selected points.

```
strongest.Location
```

```
ans = 10x2 single matrix
```

```
183.2607 205.7324
112.7613 206.8682
140.7289 96.1705
135.5473 125.4136
101.5411 174.0036
111.1929 156.2148
167.3374 77.7732
131.6280 114.0382
114.2321 48.5672
135.2517 92.6351
```

Detect SIFT Features and Display Points

Read an image into the workspace.

```
I = imread("cameraman.tif");
```

Detect SIFT features in the image.

```
points = detectSIFTFeatures(I);
```

Display the last 5 detected points.

```
imshow(I)
hold on
plot(points(end-4:end))
```



Tips

- Although `SIFTPoints` may hold many points, it is a scalar object. Therefore, `numel(SIFTPoints)` always returns 1. This value may differ from `length(SIFTPoints)`, which returns the true number of points held by the object.
- Properties can be specified as a scalar or a vector whose length matches the number of coordinates in `location`.

References

- [1] Lowe, David G.. "Distinctive Image Features from Scale-Invariant Keypoints." *Int. J. Comput. Vision* 60 , no. 2 (2004): 91--110.

Extended Capabilities

C/C++ Code Generation

Generate C and C++ code using MATLAB® Coder™.

Usage notes and limitations:

- To index locations with this object, use the syntax: `points.Location(idx,:)`, for `points` object. See `visionRecoverformCodeGeneration_kernel.m`, which is used in the "Introduction to Code Generation with Feature Matching and Registration" example.

See Also

Objects

MSERRegions | BRISKPoints | cornerPoints | detectORBFeatures | ORBPoints

Functions

detectSIFTFeatures | detectBRISKFeatures | detectKAZEFeatures | detectFASTFeatures
| detectORBFeatures | detectMinEigenFeatures | detectHarrisFeatures |
detectMSERFeatures | detectSURFFeatures | extractFeatures | matchFeatures

Topics

“Detect SURF Interest Points in a Grayscale Image” on page 3-425

“Display MSER Feature Regions from the MSERRegions Object” on page 2-457

“Find MSER Regions in an Image” on page 3-413

“Detect MSER Features in an Image” on page 2-456

Introduced in R2021b

pcmapndt

Localization map based on normal distributions transform (NDT)

Description

The `pcmapndt` object creates a normal distributions transform (NDT) map from a prebuilt point cloud map of the environment. The NDT map is a compressed, memory-efficient representation suitable for localization. The object converts the point cloud map into a set of voxels (3-D boxes), each represented by a 3-D normal distribution. Use the `selectSubmap` object function to select a submap within the map from a coarse position estimate. Use the `findPose` object function to localize the pose of the sensor based on the assembled map.

Creation

Syntax

```
ndtMap = pcmapndt(ptCloudMap, voxelSize)
```

Description

`ndtMap = pcmapndt(ptCloudMap, voxelSize)` returns an NDT map from a point cloud map, `ptCloudMap`.

Properties

SelectedSubmap — Currently selected submap

entire map (default) | 6-element vector

This property is read-only.

Currently selected submap, specified as a 6-element vector of the form `[xmin,xmax ymin ymax zmin zmax]` that describes the range of the submap along each axis. The elements of the vector describe the region of interest represented by the submap.

VoxelSize — Size of voxels

scalar

This property is read-only.

Size of the voxels, specified as a scalar value in world units.

XLimits — Range of map along x-axis

2-element vector

This property is read-only.

Range of the map along the x-axis, specified as a 2-element vector of the form `[xmin xmax]`.

YLimits — Range of map along the Y-axis

2-element vector

This property is read-only.

Range of the map along the Y -axis, specified as a 2-element vector of the form $[ymin\ ymax]$.

ZLimits — Range of map along the z-axis

2-element vector

This property is read-only.

Range of the map along the z -axis, specified as a 2-element vector of the form $[zmin\ zmax]$.

VoxelMean — Mean value of each voxel M -by-3 matrix

This property is read-only.

Mean value of each voxel, specified as an M -by-3 matrix. Each row of the matrix contains the $[x\ y\ z]$ values for a voxel. M is the number of voxels.

VoxelCovariance — Covariance of each voxel3-by-3-by- M array

This property is read-only.

Covariance of each voxel, specified as a 3-by-3-by- M array for M voxels.

VoxelNumPoints — Number of points in each voxel M -by-1 vector

This property is read-only.

Number of points in each voxel, specified as an M -by-1 vector for M voxels.

Object Functions

<code>selectSubmap</code>	Select submap within map
<code>isInsideSubmap</code>	Check if query position is inside selected submap
<code>findPose</code>	Localize a point cloud within a map using the normal distributions transform (NDT) algorithm
<code>show</code>	Visualize normal distributions transform (NDT) map

Examples**Create an NDT Map Representation**

Load a point cloud view set, which was saved from a `pcviewset` object.

```
data = load('vSetPointClouds.mat');
vSet = data.vSet;
```

Extract point clouds and absolute poses to build a map.

```
ptClouds = vSet.Views.PointCloud;  
tforms    = vSet.Views.AbsolutePose;
```

Create a point cloud map by aligning the point cloud scans using the absolute poses.

```
ptCloudMap = pcalign(ptClouds,tforms);
```

Create and visualize an NDT map from a point cloud map.

```
voxelSize = 1;  
ndtMap = pemapndt(ptCloudMap,voxelSize);  
figure  
show(ndtMap)  
view(2)    % Change viewing angle to top-view
```

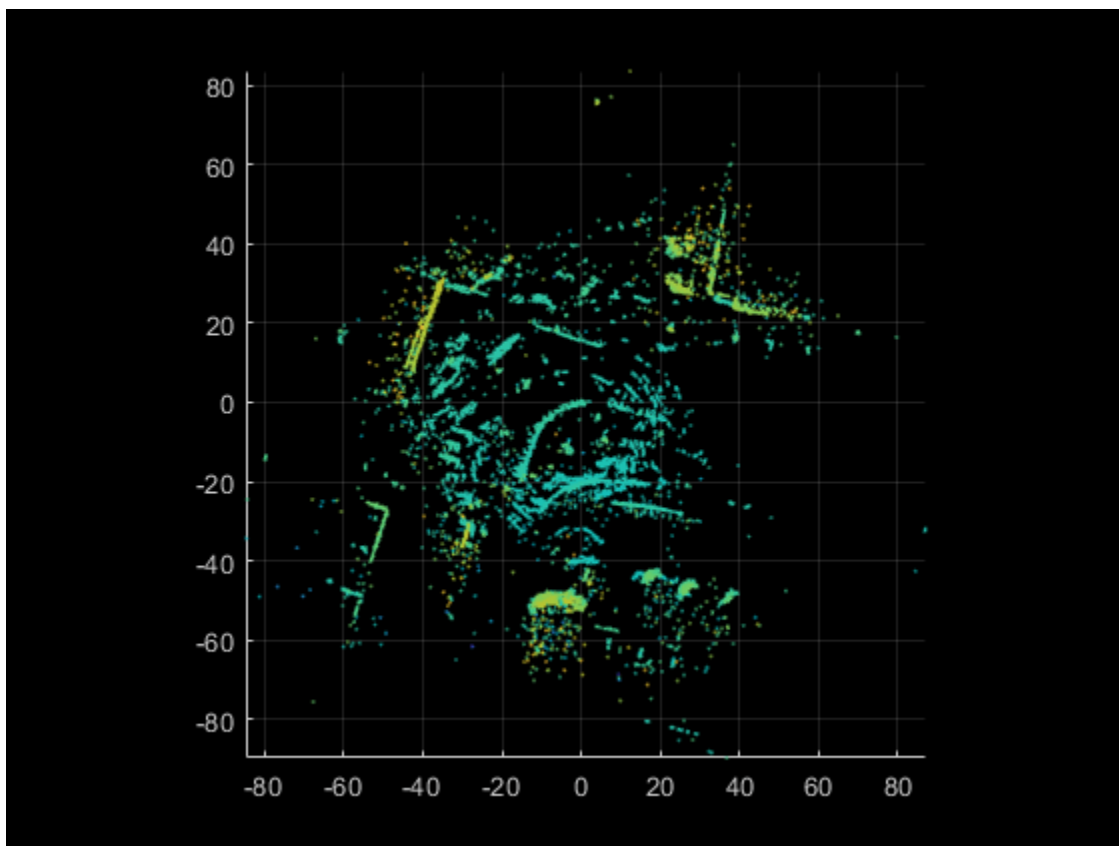

Lidar Localization Using NDT

Load a normal distributions transform (NDT) map from a MAT file.

```
data = load('ndtMapParkingLot.mat');  
ndtMap = data.ndtMapParkingLot;
```

Load point cloud scans and pose estimates from a second MAT file.

```
data = load('parkingLotData.mat');
ptCloudScans = data.parkingLotData.ptCloudScans;
initPoseEsts = data.parkingLotData.initPoseEsts;
```

Display the NDT map.

```
show(ndtMap)
```

Change the viewing angle to top-view.

```
view(2)
```

Select the submap centered around the first estimate.

```
center = initPoseEsts(1).Translation;
sz = [70 50 20];
ndtMap = selectSubmap(ndtMap,center,sz);
```

Set the radius for visualization of the current location and the distance threshold to update the submap.

```
radius = 0.5;
distThresh = 15;
```

Loop over the point clouds, localize them in the map, and update the selected submap as needed.

```
numScans = numel(ptCloudScans);

for n = 1:numScans
    ptCloud = ptCloudScans(n);
    initPose = initPoseEsts(n);

    poseTranslation = initPose.Translation;
    [isInside,distToEdge] = isInsideSubmap(ndtMap,poseTranslation);
    submapNeedsUpdate = ~isInside ... % Current pose is outside submap
        || any(distToEdge(1:2) < distThresh); % Current pose is close to submap edge

    if submapNeedsUpdate
        ndtMap = selectSubmap(ndtMap,poseTranslation,sz);
    end

    % Localize the point cloud scan in the map.
    currPose = findPose(ndtMap,ptCloud,initPose);

    % Display the position of the estimate as a circle.
    pos = [currPose.Translation(1:2) radius];
    showShape('circle',pos,'Color','r');

    % Pause to view the change.
    pause(0.05)
end
```

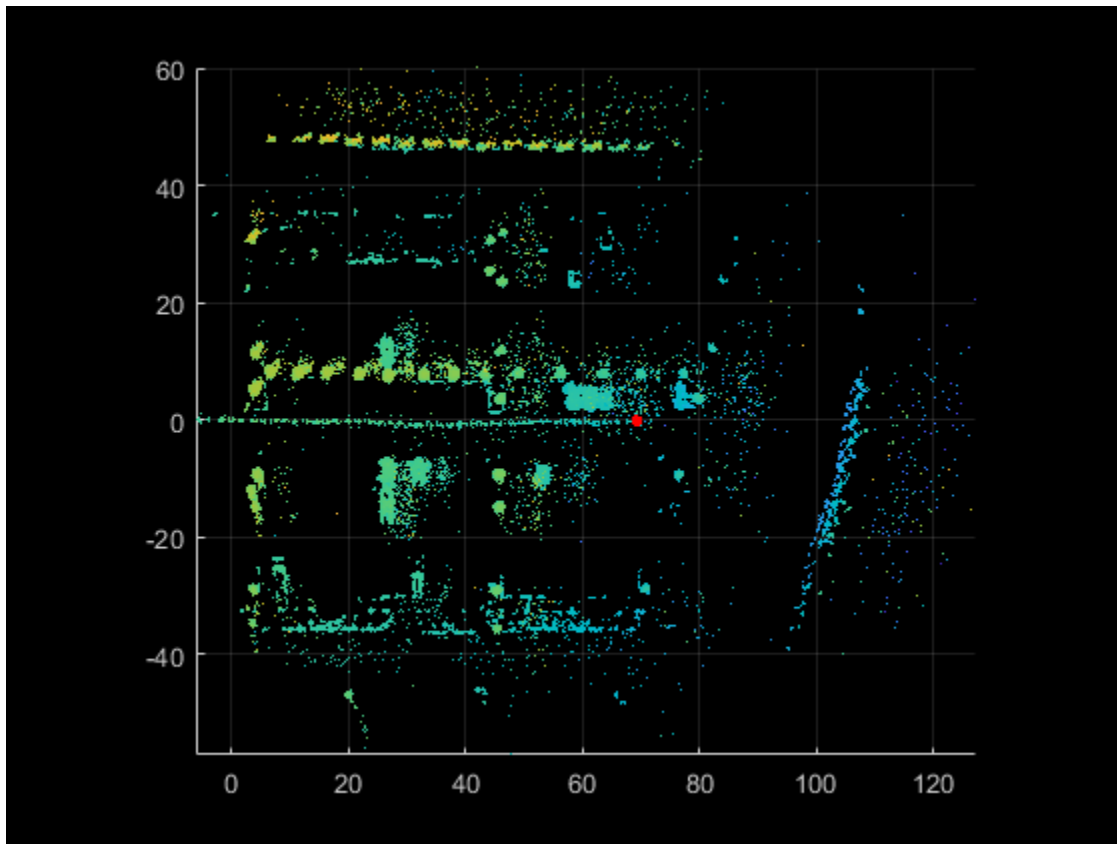

References

Biber, P., and W. Strasser. "The Normal Distributions Transform: A New Approach to Laser Scan Matching." In *Proceedings 2003 IEEE/RSJ International Conference on Intelligent Robots and Systems (IROS 2003) (Cat. No.03CH37453)* Vol. 3, 2743-48. Las Vegas, Nevada, USA: IEEE, 2003. <https://doi.org/10.1109/IROS.2003.1249285>.

[1] Magnusson, Martin. "The Three-Dimensional Normal-Distributions Transform: An Efficient Representation for Registration, Surface Analysis, and Loop Detection." PhD thesis, Örebro universitet, 2009. <http://urn.kb.se/resolve?urn=urn:nbn:se:oru:diva-8458>
urn:nbn:se:oru:diva-8458.

Extended Capabilities

C/C++ Code Generation

Generate C and C++ code using MATLAB® Coder™.

GPU Code Generation

Generate CUDA® code for NVIDIA® GPUs using GPU Coder™.

Usage notes and limitations:

- Because of architectural differences between the CPU and the GPU, there may be minor differences in results from simulation and code generation.

- In certain cases, there may be differences in the location of points in a voxel between simulation and code generation. However, the total number of points remains the same.

See Also

Functions

`selectSubmap` | `findPose` | `pcregisterndt` | `pcalign`

Introduced in R2021a

selectSubmap

Select submap within map

Syntax

```
ndtMapOut = selectSubmap(ndtMapIn, roi)
ndtMapOut = selectSubmap(ndtMapIn, center, sz)
```

Description

`ndtMapOut = selectSubmap(ndtMapIn, roi)` selects a submap within the NDT map `ndtMapIn` using the specified region of interest `roi`.

Use this function to confine the search space for localization when using coarse position estimates.

`ndtMapOut = selectSubmap(ndtMapIn, center, sz)` selects a submap specified by the center `center` and size `sz` of the submap.

Examples

Lidar Localization Using NDT

Load a normal distributions transform (NDT) map from a MAT file.

```
data = load('ndtMapParkingLot.mat');
ndtMap = data.ndtMapParkingLot;
```

Load point cloud scans and pose estimates from a second MAT file.

```
data = load('parkingLotData.mat');
ptCloudScans = data.parkingLotData.ptCloudScans;
initPoseEsts = data.parkingLotData.initPoseEsts;
```

Display the NDT map.

```
show(ndtMap)
```

Change the viewing angle to top-view.

```
view(2)
```

Select the submap centered around the first estimate.

```
center = initPoseEsts(1).Translation;
sz = [70 50 20];
ndtMap = selectSubmap(ndtMap, center, sz);
```

Set the radius for visualization of the current location and the distance threshold to update the submap.

```
radius = 0.5;
distThresh = 15;
```

Loop over the point clouds, localize them in the map, and update the selected submap as needed.

```

numScans = numel(ptCloudScans);

for n = 1:numScans
    ptCloud = ptCloudScans(n);
    initPose = initPoseEsts(n);

    poseTranslation = initPose.Translation;
    [isInside,distToEdge] = isInsideSubmap(ndtMap,poseTranslation);
    submapNeedsUpdate = ~isInside ...           % Current pose is outside submap
        || any(distToEdge(1:2) < distThresh); % Current pose is close to submap edge

    if submapNeedsUpdate
        ndtMap = selectSubmap(ndtMap,poseTranslation,sz);
    end

    % Localize the point cloud scan in the map.
    currPose = findPose(ndtMap,ptCloud,initPose);

    % Display the position of the estimate as a circle.
    pos = [currPose.Translation(1:2) radius];
    showShape('circle',pos,'Color','r');

    % Pause to view the change.
    pause(0.05)
end

```

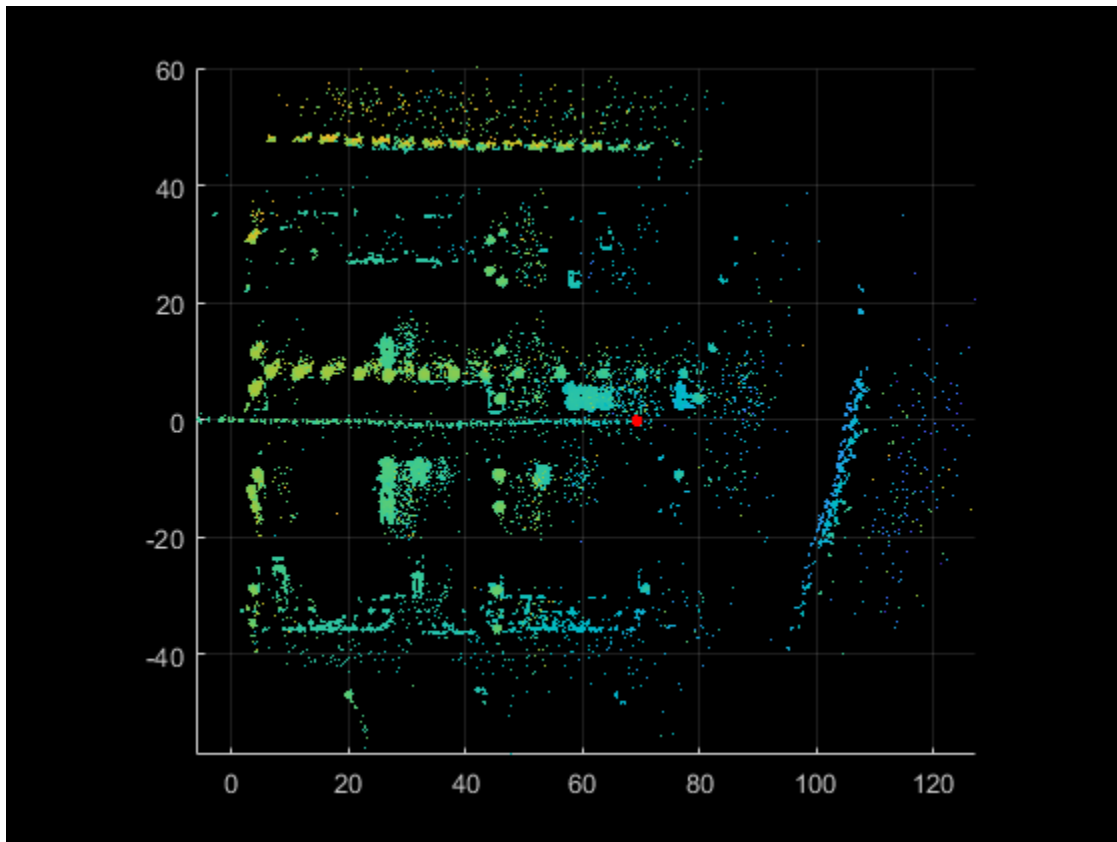

Input Arguments

ndtMapIn — NDT map

pcmapndt object

NDT map, specified as a `pcmapndt` object.

roi — Region of interest

6-element vector

Region of interest, specified as a 6-element vector of the form `[xmin xmax ymin ymax zmin zmax]`.

center — Center of submap

3-element vector

Center of the submap, specified as 3-element vector of the form `[xc yc zc]`.

sz — Size of submap along each axis

3-element vector

Size of the submap along each axis, specified as 3-element vector of the form `[xsz ysz zsz]`.

Output Arguments

ndtMapOut — NDT map

pcmapndt object

NDT map, returned as a `pcmapndt` object with an updated `SelectedSubmap` property.

If a region of the selected submap is outside of the limits of the map, the selected submap is constrained to the map limits as described by the `XLimits`, `YLimits`, and `ZLimits` properties of the `pcmapndt` object.

Tips

- Use a submap size large enough to include the uncertainty of the position estimates and the range of the sensor used with `findPose`. A larger submap can increase computation time during each call to the `findPose` function, but it can also reduce the frequency of submap updates.

Extended Capabilities

C/C++ Code Generation

Generate C and C++ code using MATLAB® Coder™.

See Also

Objects

`pcmapndt`

Functions

`isInsideSubmap` | `show` | `showShape`

Introduced in R2021a

isInsideSubmap

Check if query position is inside selected submap

Syntax

```
isInside = isInsideSubmap(ndtMap pos)
[isInside,distToEdge] = isInsideSubmap(ndtMap,pos)
```

Description

`isInside = isInsideSubmap(ndtMap pos)` check if the query position `pos`, is inside the selected submap of the NDT map `ndtMap`.

`[isInside,distToEdge] = isInsideSubmap(ndtMap,pos)` also returns the distance from the query position to the closest edge of the submap along the X-,Y-, and Z-axes respectively.

Examples

Check if Query Position Is in Submap

Load an NDT map from a MAT file.

```
data = load('ndtMapParkingLot.mat');
ndtMap = data.ndtMapParkingLot;
```

Select a submap with a specified center and set size.

```
center = [40 0 0];
sz = [50 50 20];
ndtMap = selectSubmap(ndtMap,center,sz);
```

Display the extent of the submap.

```
disp(ndtMap.SelectedSubmap)
    15.0000    65.0000   -25.0000    25.0000   -9.1840    5.4975
```

Check if a query position is inside the submap.

```
pos1 = [40 0 0]; % near center
[isInside1,distToEdge1] = isInsideSubmap(ndtMap,pos1)
```

```
isInside1 = logical
    1
```

```
distToEdge1 = 1x3
    25.0000    25.0000    5.4975
```

```

pos2 = [66 0 0]; % completely outside
[isInside2,distToEdge2] = isInsideSubmap(ndtMap,pos2)

isInside2 = logical
          0

distToEdge2 = 1x3

          1.0000    25.0000    5.4975

pos3 = [60 0 0]; % inside, 5 meters from edge in x direction
[isInside3,distToEdge3] = isInsideSubmap(ndtMap,pos3)

isInside3 = logical
          1

distToEdge3 = 1x3

          5.0000    25.0000    5.4975

```

Input Arguments

ndtMap — NDT map

pcmapndt object

NDT map, specified as a pcmapndt object.

pos — Query position

3-element vector

Query position, specified as a 3-element vector of the form [x y z].

Output Arguments

isInside — Indication of position inside submap

true | false

Indication of position inside submap, returned as a logical true or false.

distToEdge — Distance from the query position to closest edge of the submap

3-element vector

Distance from the query position to the closest edge of the submap in the X-, Y-, and Z-axes respectively, returned as a 3-element vector.

Extended Capabilities

C/C++ Code Generation

Generate C and C++ code using MATLAB® Coder™.

See Also

Functions

selectSubmap | findPose

Objects

pcmapndt

Introduced in R2021a

findPose

Localize a point cloud within a map using the normal distributions transform (NDT) algorithm

Syntax

```
currPose = findPose(ndtMap,ptCloud,initPose)
currPose = findPose( ___,Name,Value)
```

Description

`currPose = findPose(ndtMap,ptCloud,initPose)` localizes the pose of the point cloud `ptCloud` within the NDT map `ndtMap` using the NDT algorithm. The function confines the search space to the submap, specified by the `SelectedSubmap` property of the `ndtMap` object.

`currPose = findPose(___,Name,Value)` specifies options using one or more name-value arguments in addition to the input arguments in previous syntax. For example, `'MaxIterations',30` sets the maximum number of iterations before the function stops the NDT algorithm.

Examples

Lidar Localization Using NDT

Load a normal distributions transform (NDT) map from a MAT file.

```
data = load('ndtMapParkingLot.mat');
ndtMap = data.ndtMapParkingLot;
```

Load point cloud scans and pose estimates from a second MAT file.

```
data = load('parkingLotData.mat');
ptCloudScans = data.parkingLotData.ptCloudScans;
initPoseEsts = data.parkingLotData.initPoseEsts;
```

Display the NDT map.

```
show(ndtMap)
```

Change the viewing angle to top-view.

```
view(2)
```

Select the submap centered around the first estimate.

```
center = initPoseEsts(1).Translation;
sz = [70 50 20];
ndtMap = selectSubmap(ndtMap,center,sz);
```

Set the radius for visualization of the current location and the distance threshold to update the submap.

```
radius = 0.5;
distThresh = 15;
```

Loop over the point clouds, localize them in the map, and update the selected submap as needed.

```

numScans = numel(ptCloudScans);

for n = 1:numScans
    ptCloud = ptCloudScans(n);
    initPose = initPoseEsts(n);

    poseTranslation = initPose.Translation;
    [isInside,distToEdge] = isInsideSubmap(ndtMap,poseTranslation);
    submapNeedsUpdate = ~isInside ...           % Current pose is outside submap
        || any(distToEdge(1:2) < distThresh); % Current pose is close to submap edge

    if submapNeedsUpdate
        ndtMap = selectSubmap(ndtMap,poseTranslation,sz);
    end

    % Localize the point cloud scan in the map.
    currPose = findPose(ndtMap,ptCloud,initPose);

    % Display the position of the estimate as a circle.
    pos = [currPose.Translation(1:2) radius];
    showShape('circle',pos,'Color','r');

    % Pause to view the change.
    pause(0.05)
end

```

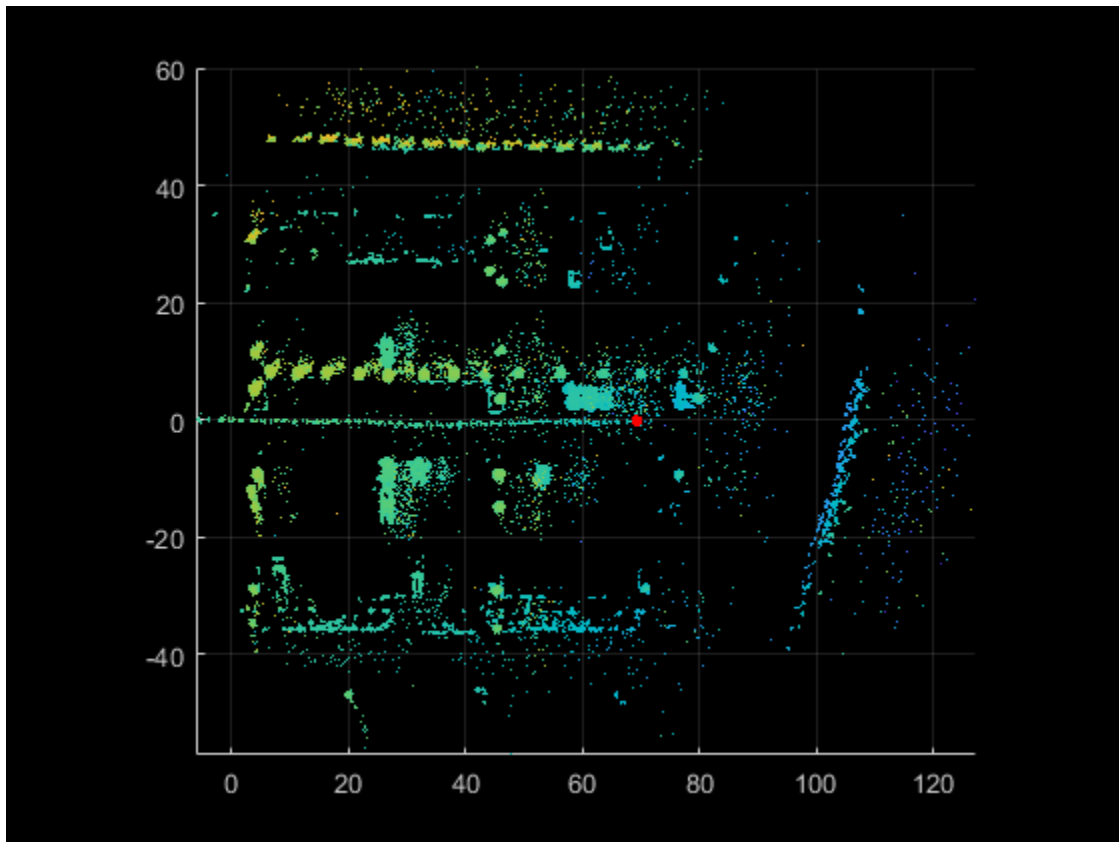

Input Arguments

ndtMap — NDT map

pcmapndt object

NDT map, specified as a pcmapndt object.

ptCloud — Point cloud

pointCloud object

Point cloud in the sensor coordinate system, specified as a pointCloud object.

initPose — Initial estimate for the pose of the sensor in the map

rigid3d object

Initial estimate for the pose of the sensor in the map, specified as a rigid3d object.

Name-Value Pair Arguments

Specify optional comma-separated pairs of *Name*, *Value* arguments. *Name* is the argument name and *Value* is the corresponding value. *Name* must appear inside quotes. You can specify several name and value pair arguments in any order as *Name1*, *Value1*, ..., *NameN*, *ValueN*.

Example: 'MaxIterations', 30 stops the NDT algorithm after 30 iterations.

OutlierRatio — Expected percentage of outliers

0.55 (default) | scalar in the range [0, 1)

Expected percentage of outliers with respect to a normal distribution, specified as a scalar in the range [0, 1). The NDT algorithm assumes a point is generated by the mixture of a normal distribution for inliers and a uniform distribution for outliers. A larger value of 'OutlierRatio' reduces the influence of outliers.

Data Types: single | double

MaxIterations — Maximum number of iterations

30 (default) | nonnegative integer

Maximum number of iterations before the NDT algorithm stops, specified as a nonnegative integer.

Data Types: single | double

Tolerance — Tolerance between consecutive NDT iterations

[0.01 0.5] (default) | 2-element vector

Tolerance between consecutive NDT iterations, specified as a 2-element vector with nonnegative values. The vector, [*Tdiff* *Rdiff*], represents the tolerance of absolute difference in translation and rotation, respectively, estimated in consecutive NDT iterations. *Tdiff* measures the Euclidean distance between two translation vectors. *Rdiff* measures the angular difference in degrees. The algorithm stops when the difference between estimated rigid transformations in the most recent consecutive iterations falls below the specified tolerance values.

Data Types: single | double

Verbose — Display progress information

false or 0 (default) | true or 1

Display progress information, specified as a logical 0 (`false`) or 1 (`true`). Set 'Verbose' to `true` to display progress information.

Data Types: `logical`

Output Arguments

currPose — Pose of sensor in map

`rigid3d` object

Pose of the sensor in the map, returned as a `rigid3d` object. The function confines the search space to the submap, specified by the `SelectedSubmap` property of `ndtMap`.

Tips

- To improve the accuracy and efficiency of localization, consider downsampling the point cloud using `pcdownsample` before using this function.

References

Biber, P., and W. Strasser. "The Normal Distributions Transform: A New Approach to Laser Scan Matching." In *Proceedings 2003 IEEE/RSJ International Conference on Intelligent Robots and Systems (IROS 2003) (Cat. No.03CH37453)* Vol. 3, 2743–48. Las Vegas, Nevada, USA: IEEE, 2003. <https://doi.org/10.1109/IROS.2003.1249285>.

[1] Magnusson, Martin. "The Three-Dimensional Normal-Distributions Transform: An Efficient Representation for Registration, Surface Analysis, and Loop Detection." PhD thesis, Örebro universitet, 2009. <http://urn.kb.se/resolve?urn=urn:nbn:se:oru:diva-8458>
[urn:nbn:se:oru:diva-8458](http://urn.kb.se/resolve?urn=urn:nbn:se:oru:diva-8458).

Extended Capabilities

C/C++ Code Generation

Generate C and C++ code using MATLAB® Coder™.

See Also

Objects

`pcmapndt` | `pointCloud` | `rigid3d`

Functions

`selectSubmap` | `show` | `pcregisterndt` | `isInsideSubmap` | `pcdownsample`

Introduced in R2021a

show

Visualize normal distributions transform (NDT) map

Syntax

```
show(ndtMap)
show(ndtMap,spatialExtent)
show( ____,Name,Value)
```

```
ax = show( ____)
```

Description

`show(ndtMap)` visualizes the NDT map as a point cloud. The function uses voxel means, covariances, and point counts to generate points for the display. These points are not the points used to build the map. The NDT map is a compressed representation of the point cloud map that stores the voxels and their 3-D normal distributions.

`show(ndtMap,spatialExtent)` displays points within the spatial map or submap specified by `spatialExtent`.

`show(____,Name,Value)` specifies options using one or more name-value arguments in addition to any combination of input arguments in previous syntaxes. For example, `'MarkerSize',6` sets the marker size to 6 points.

`ax = show(____)` returns the axes used to plot the NDT map.

Examples

Select and Visualize Submap

Load an NDT map from a MAT file.

```
data = load('ndtMapParkingLot.mat');
ndtMap = data.ndtMapParkingLot;
```

Select a submap from within the loaded NDT map at the specified location and size.

```
center = [50 0 0];
sz      = [50 50 10];
ndtMap = selectSubmap(ndtMap,center,sz);
```

Visualize the full NDT map.

```
figure
show(ndtMap)
title('Full NDT Map')
```

Highlight the selected submap on the full NDT map.

```
pos = [center,sz,zeros(1, 3)];  
showShape('cuboid',pos,'Color','y','Opacity',0.2);
```

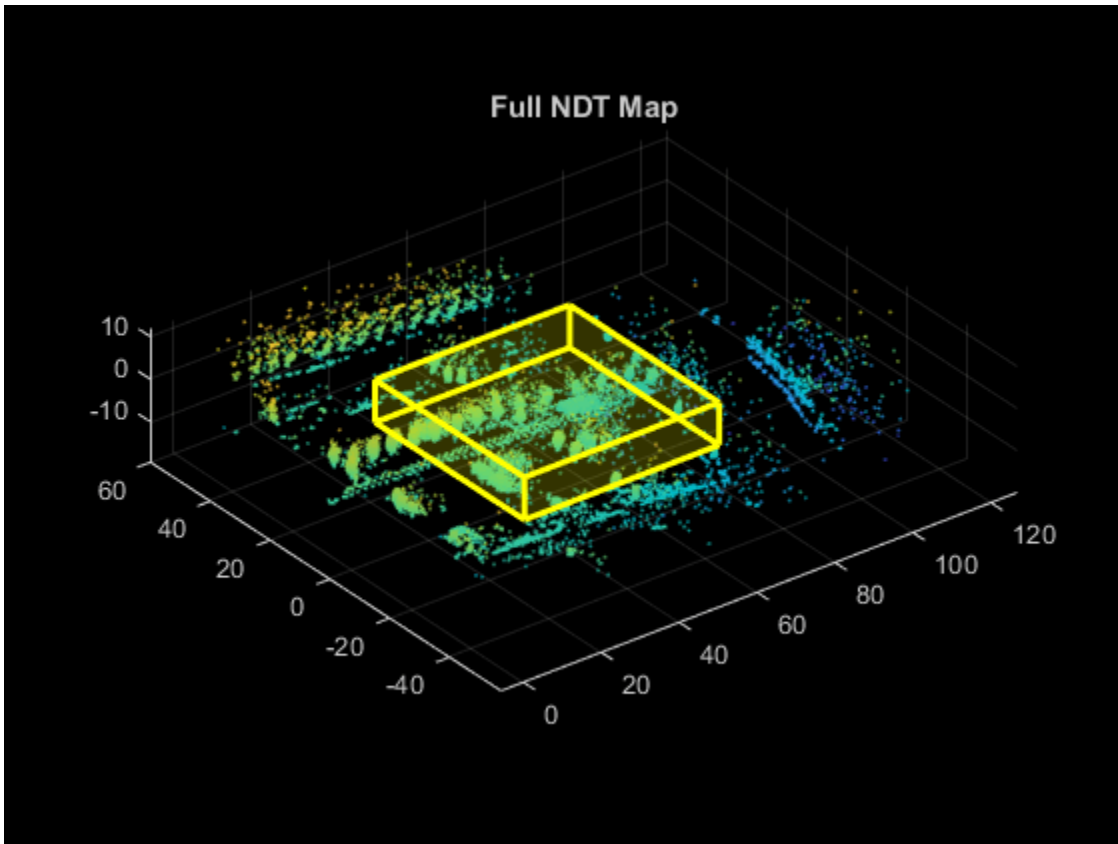

Visualize the selected submap.

```
figure  
show(ndtMap,'submap')  
title('Selected Submap')
```

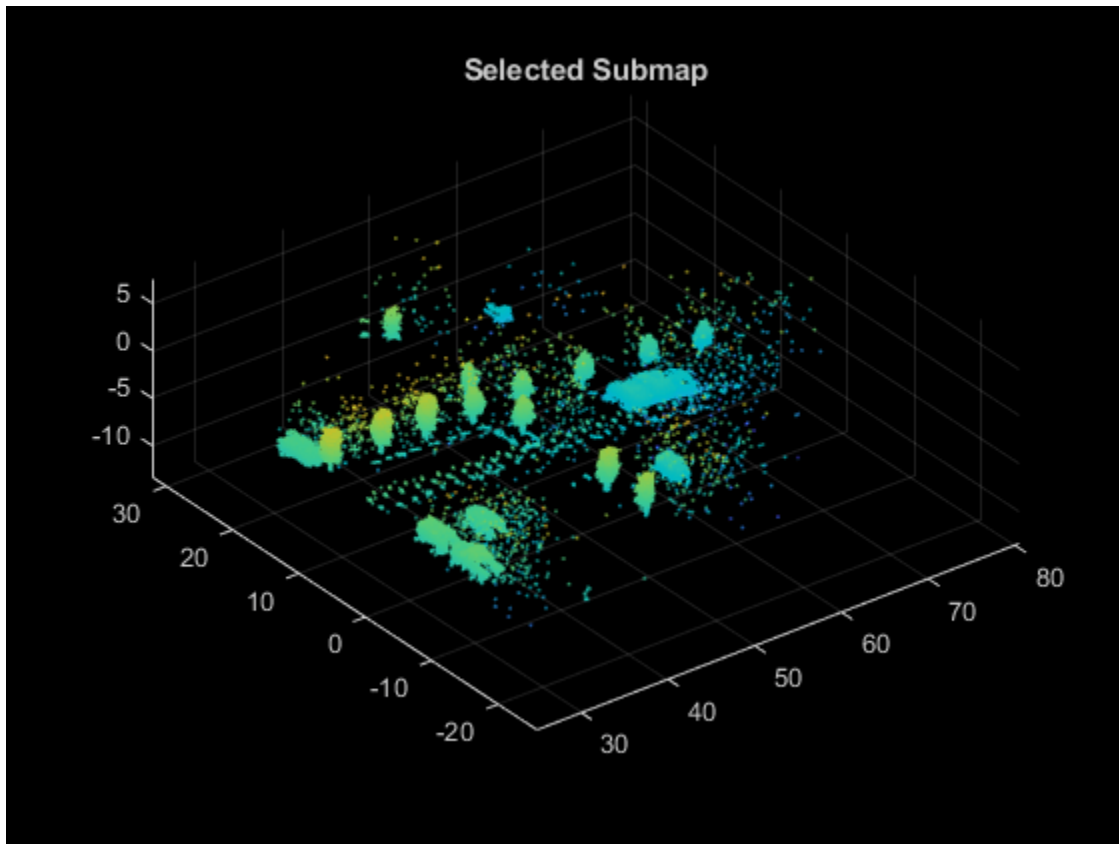

Input Arguments

ndtMap — NDT map

pcmapndt object

NDT map, specified as a pcmapndt object.

spatialExtent — Spatial extent

'map' | 'submap'

Spatial extent, specified as 'map' or 'submap'. When you specify 'submap', only points within the current submap are displayed.

Name-Value Pair Arguments

Specify optional comma-separated pairs of **Name**, **Value** arguments. **Name** is the argument name and **Value** is the corresponding value. **Name** must appear inside quotes. You can specify several name and value pair arguments in any order as **Name1**, **Value1**, ..., **NameN**, **ValueN**.

Example: 'MarkerSize',6 sets the marker size to 6 points.

MarkerSize — Diameter of marker

6 (default) | positive scalar

Diameter of marker, specified as a positive scalar. This value specifies the approximate diameter of the point marker. Units are in points. A marker size larger than six can reduce rendering performance.

Parent — Axes on which to display visualization

Axes object

Axes on which to display the visualization, specified as an Axes object. To create an Axes object, use the `axes` function. To display the visualization in a new figure, leave 'Parent' unspecified.

Output Arguments**ax — Plot axes**

Axes object

Plot axes, returned as an axes graphics object.

See Also**Objects**

`pcmapndt`

Functions

`pcshow` | `selectSubmap`

Introduced in R2021a

worldpointset

Manage 3-D to 2-D point correspondences

Description

The `worldpointset` object stores correspondences between 3-D world points and 2-D image points across camera views. You can use a `worldpointset` object with an `imageviewset` object to manage image and map data for structure-from-motion, visual odometry, and visual simultaneous localization and mapping (SLAM).

Creation

Syntax

```
wpSet = worldpointset
```

Description

`wpSet = worldpointset` creates a `worldpointset` object with default properties. Use the object functions to perform actions such as adding, modifying or removing correspondences, finding points in a view, and finding views of points.

Properties

WorldPoints — 3-D world points

[] (default) | M -by-3 matrix

This property is read-only.

3-D world points, specified as an M -by-3 matrix with rows containing $[x\ y\ z]$ world points. M is the number of 3-D world points.

ViewIds — Identifiers for views

[] (default) | N -element row vector of integers

This property is read-only.

Identifiers for views associated with world points, specified as an N -element row vector of integers.

Count — Number of 3-D world points

0 (default) | scalar

This property is read-only.

Number of 3-D world points, specified as a scalar.

Correspondences — 3-D to 2-D point correspondences

empty three-column table (default) | three-column table

This property is read-only.

3-D to 2-D point correspondences, specified as a three-column table.

Column	Description
PointIndex	Each row contains the linear index of a world point.
ViewId	Each row contains a 1-by- N vector specifying the IDs of the views associated with the corresponding world points. N is the number of views associated with the world point.
FeatureIndex	Each row contains a 1-by- N vector specifying the indices of the feature points that correspond to the world point. Each element is the index of the feature point in the view specified by the corresponding element in the ViewID cell.

Object Functions

addWorldPoints	Add world points to world point set
removeWorldPoints	Remove world points from world point set
updateWorldPoints	Update world points in world point set
addCorrespondences	Update world points in a world point set
removeCorrespondences	Remove 3-D to 2-D correspondences from world point set
updateCorrespondences	Update 3-D to 2-D correspondences in world point set
findViewsOfWorldPoint	Find views that observe a world point
findWorldPointsInTracks	Find world points that correspond to point tracks
findWorldPointsInView	Find world points observed in view

Examples

Triangulate Stereo Images

Load a MAT -file containing stereo parameters into the workspace.

```
load('webcamsSceneReconstruction.mat');
```

Read a stereo pair of images into the workspace.

```
I1 = imread('sceneReconstructionLeft.jpg');
I2 = imread('sceneReconstructionRight.jpg');
```

Undistort the images.

```
I1 = undistortImage(I1, stereoParams.CameraParameters1);
I2 = undistortImage(I2, stereoParams.CameraParameters2);
```

Define a rectangular region of interest (ROI), in the format `[x y width height]`.

```
roi = [30 30 size(I1,2)-30 size(I1,1)-30];
```

Detect and extract Speeded-Up Robust Features (SURF) from both images using the ROI.

```
imagePoints1 = detectSURFFeatures(im2gray(I1), 'ROI', roi);  
imagePoints2 = detectSURFFeatures(im2gray(I2), 'ROI', roi);
```

```
[feature1, validPoints1] = extractFeatures(im2gray(I1), imagePoints1, 'Upright', true);  
[feature2, validPoints2] = extractFeatures(im2gray(I2), imagePoints2, 'Upright', true);
```

Match the extracted features to each other.

```
indexPairs = matchFeatures(feature1, feature2);
```

Compute the 3-D world points.

```
matchedPoints1 = validPoints1(indexPairs(:,1));  
matchedPoints2 = validPoints2(indexPairs(:,2));  
worldPoints = triangulate(matchedPoints1, matchedPoints2, stereoParams);
```

Create a `worldpointset` object to manage correspondences.

```
wpSet = worldpointset;
```

Add the world points to the `worldpointset`.

```
[wpSet, newPointIndices] = addWorldPoints(wpSet, worldPoints);
```

Add the 3-D to 2-D point correspondences to the `worldpointset`.

```
wpSet = addCorrespondences(wpSet, 1, newPointIndices, indexPairs(:,1));  
wpSet = addCorrespondences(wpSet, 2, newPointIndices, indexPairs(:,2));
```

Display the world points.

```
pcshow(wpSet.WorldPoints, 'VerticalAxis', 'y', 'VerticalAxisDir', 'down', 'MarkerSize', 45)
```

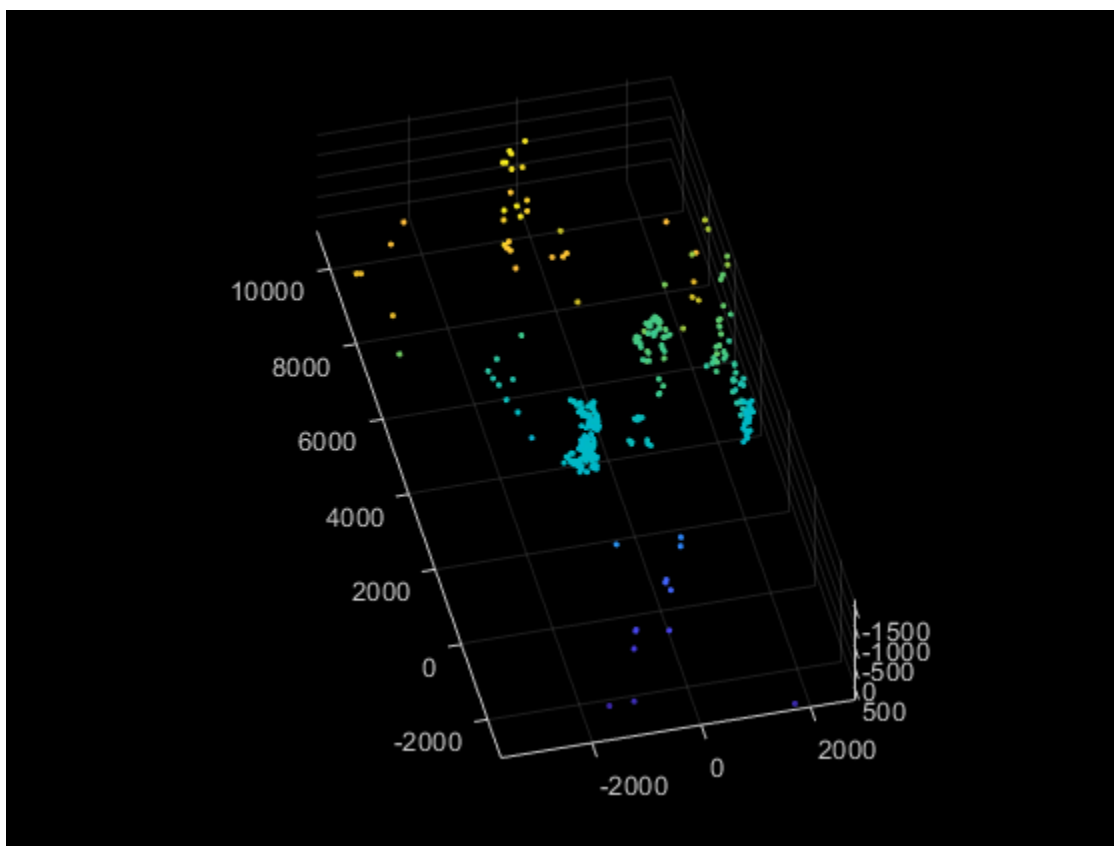

See Also

Functions

pointTrack

Objects

imageviewset

Topics

“Monocular Visual Simultaneous Localization and Mapping”

Introduced in R2020b

addCorrespondences

Update world points in a world point set

Syntax

```
wpSet = addCorrespondences(wpSet,viewId,pointIndices,featureIndices)
```

Description

`wpSet = addCorrespondences(wpSet,viewId,pointIndices,featureIndices)` adds correspondences between the specified 3-D world points `pointIndices` and 2-D feature points `featureIndices` for the specified by view `viewId` to a world point set `wpSet`.

Examples

Add 3-D to 2-D Correspondences to World Point Set

Generate 3-D world points.

```
worldPoints = rand(100,3);
```

Create a `worldpointset` object.

```
wpSet = worldpointset;
```

Add world points.

```
wpSet = addWorldPoints(wpSet,worldPoints);
```

Add correspondences to View 1 for the first 10 points.

```
viewId = 1;
pointIndices = 1:10;
featureIndices = 1:10;
wpSet = addCorrespondences(wpSet,viewId,pointIndices,featureIndices);
```

Input Arguments

wpSet — World point set

`worldpointset` object

World point set, specified as a `worldpointset` object.

viewId — View identifier

scalar

View identifier, specified as a scalar.

pointIndices — World point indices

M -element column vector of integers

World point indices, specified as an M -element column vector of integers. M is the number of world points for which you are adding correspondences.

featureIndices — 2-D feature point indices

M -element column vector of integers

Feature point indices, specified as an M -element column vector of integers. M is the number of world points for which you are adding correspondences.

Output Arguments**wpSet — World point set**

worldpointset object

World point set, returned as a worldpointset object.

See Also**Functions**

updateCorrespondences | removeCorrespondences

Objects

imageviewset | worldpointset

Introduced in R2020b

addWorldPoints

Add world points to world point set

Syntax

```
wpSet = addWorldPoints(wpSet,worldPoints)
[wpSet,newPointIndices] = addWorldPoints(wpSet,worldPoints)
```

Description

`wpSet = addWorldPoints(wpSet,worldPoints)` adds world points to the world points set `wpSet`.

`[wpSet,newPointIndices] = addWorldPoints(wpSet,worldPoints)` additionally returns the indices in the world point set of the added world points.

Examples

Add World Points to World Point Set

Generate 3-D world points.

```
worldPoints = rand(100,3);
```

Create a `worldpointset` object.

```
wpSet = worldpointset
```

Add the world points to the world point set.

```
wpSet = addWorldPoints(wpSet,worldPoints)
```

Input Arguments

wpSet — World point set

`worldpointset` object

World point set, specified as a `worldpointset` object.

worldPoints — World points coordinates

M -by-3 matrix

World points coordinates, specified as an M -by-3 matrix in the form $[x\ y\ z]$.

Output Arguments

wpSet — World point set

`worldpointset` object

World point set, returned as a `worldpointset` object.

newPointIndices — Added world point indices

M-element column vector of integers

Added world point indices, returned as an *M*-element column vector of integers. *M* is the number of world points added to the world point set.

See Also

Objects

`worldpointset`

Functions

`removeWorldPoints` | `updateWorldPoints`

Introduced in R2020b

findViewsOfWorldPoint

Find views that observe a world point

Syntax

```
viewIds = findViewsOfWorldPoint(wpSet,pointIndex)
[viewIds,featureIndices] = findViewsOfWorldPoint(wpSet,pointIndex)
```

Description

`viewIds = findViewsOfWorldPoint(wpSet,pointIndex)` finds the identifiers for views `viewIds` that observe the specified 3-D world points `pointIndex` in a world point set `wpSet`.

`[viewIds,featureIndices] = findViewsOfWorldPoint(wpSet,pointIndex)` additionally returns the indices of the 2-D feature points that correspond to each 3-D world point for each associated view.

Examples

Find Views of World Points

Generate 3-D world points.

```
worldPoints = rand(100,3);
```

Create a `worldpointset` object.

```
wpSet = worldpointset;
```

Add world points.

```
wpSet = addWorldPoints(wpSet,worldPoints);
```

Add 3-D to 2-D correspondences for view 1.

```
viewId1 = 1;
pointIndices1 = 1:10;
featureIndices1 = 1:10;
wpSet = addCorrespondences(wpSet,viewId1,pointIndices1,featureIndices1);
```

Add 3-D to 2-D correspondences for view 2.

```
viewId2 = 2;
pointIndices2 = 6:10;
featureIndices2 = 1:5;
wpSet = addCorrespondences(wpSet,viewId2,pointIndices2,featureIndices2);
```

Find views of world points.

```
pointIndex = 6:10;
viewIds = findViewsOfWorldPoint(wpSet,pointIndex);
```

Input Arguments

wpSet — World point set

`worldpointset` object

World point set, specified as a `worldpointset` object.

pointIndex — World point indices

scalar | N -element vector of integers

World point indices, specified as a scalar or an N -element vector of integers.

Output Arguments

viewIds — View identifiers

M -element column vector | N -element cell array

View identifiers, returned as an M -element column vector or N -element cell array. The function returns an M -element vector column, where M is the number of views that observe the world point, when `pointIndex` is a scalar. The function returns an N -element cell array when `pointIndex` is an N -element vector of integers. Each cell contains a column vector of the view identifiers for the associated world point.

featureIndices — 2-D feature point indices

M -element column vector | N -element cell array

2-D feature point indices, returned as an M -element column vector or N -element cell array. The function returns an M -element vector column, where M is the number of views that observe the world point, when `pointIndex` is a scalar. The function returns an N -element cell array when `pointIndex` is an N -element vector of integers. Each cell contains a column vector of the corresponding feature indices for the associated world point.

See Also

Functions

`findWorldPointsInView`

Objects

`imageviewset` | `worldpointset`

Introduced in R2020b

findWorldPointsInTracks

Find world points that correspond to point tracks

Syntax

```
pointIndices = findWorldPointsInTracks(wpSet,tracks)
[pointIndices,validIndex] = findWorldPointsInTracks(wpSet,tracks)
```

Description

`pointIndices = findWorldPointsInTracks(wpSet,tracks)` finds the indices of world points `pointIndices` that correspond to the specified point tracks `tracks`.

`[pointIndices,validIndex] = findWorldPointsInTracks(wpSet,tracks)` additionally returns a vector that indicates whether each point track has a corresponding world point.

Examples

Find World Points in Tracks

Load precomputed world point set and image view set.

```
data = load(fullfile(toolboxdir('vision'),'visiondata','worldpointsetAndTracks.mat'));
```

Find point tracks across views.

```
tracks = findTracks(data.vSet);
```

Find 3-D world points corresponding to point tracks.

```
pointIndices = findWorldPointsInTracks(data.wpSet,tracks);
```

Input Arguments

wpSet — World point set

worldpointset object

World point set, specified as a worldpointset object.

tracks — Point tracks

M -element row vector of pointTrack objects

Point tracks, specified as an M -element row vector of pointTrack objects.

Output Arguments

pointIndices — 3-D world point indices

N -element column vector

3-D world point indices, returned as an N -element column vector. N is the number of world points for which the function detects corresponding point tracks.

validIndex — Logical index

M -element logical vector

Logical index of point track correspondences, returned as an M -element logical vector. M is the number of point tracks in the `tracks` argument. A value of 1 (true) indicates that the associated point track has a corresponding world point, and a value of 0 (false) indicates that it does not.

See Also**Functions**

`findTracks` | `findWorldPointsInView` | `findViewsOfWorldPoint`

Objects

`imageviewset` | `worldpointset`

Introduced in R2020b

findWorldPointsInView

Find world points observed in view

Syntax

```
pointIndices = findWorldPointsInView(wpSet,viewId)
[pointIndices,featureIndices] = findWorldPointsInView(wpSet,viewId)
```

Description

`pointIndices = findWorldPointsInView(wpSet,viewId)` finds the indices of the 3-D world points `pointIndices` observed in the specified view `viewId`.

`[pointIndices,featureIndices] = findWorldPointsInView(wpSet,viewId)` additionally returns the indices of the corresponding 2-D feature points in the view.

Examples

Find World Points in World Points Set

Generate 3-D world points.

```
worldPoints = rand(100,3);
```

Create a `worldpointset` object.

```
wpSet = worldpointset;
```

Add world points.

```
wpSet = addWorldPoints(wpSet,worldPoints);
```

Add 3-D to 2-D correspondences for view 1.

```
viewId1 = 1;
pointIndices1 = 1:10;
featureIndices1 = 1:10;
wpSet = addCorrespondences(wpSet,viewId1,pointIndices1,featureIndices1);
```

Add 3-D to 2-D correspondences for view 2.

```
viewId2 = 2;
pointIndices2 = 6:10;
featureIndices2 = 1:5;
wpSet = addCorrespondences(wpSet,viewId2,pointIndices2,featureIndices2);
```

Find world points in view 2.

```
[pointIndices,featureIndices] = findWorldPointsInView(wpSet,viewId2)
```

```
pointIndices = 5×1
```

```
6
7
8
9
10
```

```
featureIndices = 5x1
```

```
1
2
3
4
5
```

Input Arguments

wpSet — World point set

worldpointset object

World point set, specified as a worldpointset object.

viewId — View identifier

scalar | N -element vector

View identifier, specified as a scalar or an N -element vector. N is the number of views specified. The dimensions of the pointIndices and featureIndices arguments depends on the value of the viewId argument.

viewId	pointIndices	featureIndices
scalar	M -element column vector	M -element column vector
N -element array	N -element cell array	N -element cell array

Output Arguments

pointIndices — 3-D world point indices

M -element column vector | N -element cell array

3-D world point indices, returned as an M -element column vector or an N -element cell array. M is the number of world points with corresponding feature points in the specified view. N is the number of views specified, and each element of the cell array contains a column vector of the world point indices with corresponding feature points in the associated view.

featureIndices — 2-D feature point indices

M -element column vector | N -element cell array

2-D feature point indices, returned as an M -element column vector or an N -element cell array. M is the number of world points with corresponding feature points in the specified view. N is the number of views specified, and each element of the cell array contains a column vector of the feature point indices in the associated view with corresponding world points.

See Also

Functions

findViewsOfWorldPoint | addCorrespondences

Objects

imageviewset

Introduced in R2020b

removeCorrespondences

Remove 3-D to 2-D correspondences from world point set

Syntax

```
wpSet = removeCorrespondences(wpSet,viewId,pointIndices)
```

Description

`wpSet = removeCorrespondences(wpSet,viewId,pointIndices)` removes the correspondences between the specified 3-D world points `pointIndices` and 2-D feature points for the specified view `viewId` from a world point set.

Examples

Remove Correspondences in World Point Set

Generate 3-D world points.

```
worldPoints = rand(100,3);
```

Create a `worldpointset` object.

```
wpSet = worldpointset;
```

Add world points.

```
wpSet = addWorldPoints(wpSet,worldPoints);
```

Add correspondences for a view.

```
viewId = 1;  
pointIndices = 1:10;  
featureIndices = 1:10;  
wpSet = addCorrespondences(wpSet,viewId,pointIndices,featureIndices);
```

Remove the first 5 correspondences.

```
pointIndices = 1:5;  
wpSet = removeCorrespondences(wpSet,viewId,pointIndices);
```

Input Arguments

wpSet — World point set

`worldpointset` object

World point set, specified as a `worldpointset` object.

viewId — View identifier

scalar

View identifier, specified as a scalar.

pointIndices — World point indices

M-element column vector of integers

World point indices, specified as an *M*-element column vector of integers. *M* is the number of world points from which to remove correspondences.

Output Arguments**wpSet — World point set**

worldpointset object

World point set, returned as a worldpointset object.

See Also**Functions**

addCorrespondences | findViewsOfWorldPoint

Objects

imageviewset | worldpointset

Introduced in R2020b

removeWorldPoints

Remove world points from world point set

Syntax

```
wpSet = removeWorldPoints(wpSet,pointIndices)
```

Description

`wpSet = removeWorldPoints(wpSet,pointIndices)` removes the world points at the specified indices `pointIndices` from the world point set `wpSet`

Examples

Remove Points from World Point Set

Generate 3-D world points.

```
worldPoints = rand(100,3);
```

Create a `worldpointset` object.

```
wpSet = worldpointset;
```

Add the world points to the world point set. Display the world point set.

```
[wpSet,newPointIndices] = addWorldPoints(wpSet,worldPoints);  
wpSet
```

```
wpSet =  
worldpointset with properties:  
  
WorldPoints: [100×3 single]  
ViewIds: [1×0 uint32]  
Count: 100  
Correspondences: [100×3 table]
```

Remove the first 50 world points from the world point set.

```
wpSet = removeWorldPoints(wpSet,newPointIndices(1:50))
```

```
wpSet =  
worldpointset with properties:  
  
WorldPoints: [50×3 single]  
ViewIds: [1×0 uint32]  
Count: 50  
Correspondences: [50×3 table]
```

Input Arguments

wpSet — World point set

worldpointset object

World point set, specified as a worldpointset object.

pointIndices — World point indices

M -element array vector of integers

World point indices, specified as an M -element vector of integers. M is the number of world points to remove from the worldpointset object.

Output Arguments

wpSet — World point set

worldpointset object

World point set, returned as a worldpointset object.

See Also

Functions

addWorldPoints | updateWorldPoints

Objects

imageviewset | worldpointset

Introduced in R2020b

updateCorrespondences

Update 3-D to 2-D correspondences in world point set

Syntax

```
wpSet = updateCorrespondences(wpSet,viewId,pointIndices,featureIndices)
```

Description

`wpSet = updateCorrespondences(wpSet,viewId,pointIndices,featureIndices)` updates the correspondences between the specified 3-D world points `pointIndices` and 2-D feature points `featureIndices` for the specified view `viewId` in a world point set `wpSet`.

Examples

Update Correspondences in World Point Set

Generate 3-D world points.

```
worldPoints = rand(100,3);
```

Create a `worldpointset` object.

```
wpSet = worldpointset;
```

Add world points.

```
wpSet = addWorldPoints(wpSet,worldPoints);
```

Add correspondences for a view.

```
viewId = 1;  
pointIndices = 1:10;  
featureIndices = 1:10;  
wpSet = addCorrespondences(wpSet,viewId,pointIndices,featureIndices);
```

Update the feature indices .

```
newFeatureIndices = 11:20;  
wpSet = updateCorrespondences(wpSet,viewId,pointIndices,newFeatureIndices);
```

Input Arguments

wpSet — World point set

`worldpointset` object

World point set, specified as a `worldpointset` object.

viewId — View identifier

scalar

View identifier, specified as a scalar.

pointIndices – World point indices

M-element column vector of integers

World point indices, specified as an *M*-element column vector of integers. *M* is the number of world points for which to update correspondences in the world point set.

featureIndices – 2-D feature point indices

M-element column vector of integers

Feature point indices, specified as an *M*-element column vector of integers. *M* is the number of world points for which to update correspondences in the world point set.

Output Arguments**wpSet – World point set**

worldpointset object

World point set, returned as a worldpointset object.

See Also**Functions**

removeCorrespondences | addCorrespondences

Objects

imageviewset | worldpointset

Introduced in R2020b

updateWorldPoints

Update world points in world point set

Syntax

```
wpSet = updateWorldPoints(wpSet,pointIndices,worldPoints)
```

Description

`wpSet = updateWorldPoints(wpSet,pointIndices,worldPoints)` updates the locations of the world points at the specified indices `pointIndices` of the world point set `wpSet`.

Examples

Update World Point Set

Generate 3-D world points.

```
worldPoints = rand(100,3);
```

Create a `worldpointset` object.

```
wpSet = worldpointset;
```

Add the world points to the world point set.

```
wpSet = addWorldPoints(wpSet,worldPoints);
```

Update the first 50 world points with new locations.

```
pointIndices = 1:50;  
newWorldPoints = worldPoints(pointIndices,:) + [0 0 5];  
wpSet = updateWorldPoints(wpSet,pointIndices,newWorldPoints);
```

Input Arguments

wpSet — World point set

`worldpointset` object

World point set, specified as a `worldpointset` object.

pointIndices — World point indices

M-element column vector of integers

World point indices, specified as an *M*-element column vector of integers. *M* is the number of world points to update in the `worldpointset` object.

worldPoints — World points coordinates

M-by-3 matrix

World points coordinates, specified as an M -by-3 matrix in the form $[x\ y\ z]$.

Output Arguments

wpSet — World point set

`worldpointset` object

World point set, returned as a `worldpointset` object.

See Also

Objects

`worldpointset`

Functions

`addWorldPoints` | `removeWorldPoints`

Introduced in R2020b

pcviewset

Manage data for point cloud based visual odometry and SLAM

Description

The `pcviewset` object stores point cloud odometry and simultaneous localization and mapping (SLAM) data as a set of views and pairwise connections between views.

Creation

Syntax

```
vSet = pcviewset
```

Description

`vSet = pcviewset` creates a `pcviewset` object with default property names. Use object functions to perform actions such as adding, modifying, or removing views or connections.

Properties

Views — View attributes

empty three-column table (default) | three-column table

This property is read-only.

View attributes, specified as a three-column table. The table contains columns as described in this table.

Column	Description
ViewID	View identifier, specified as an integer. View identifiers are unique to a specific view.
AbsolutePose	Absolute pose of the view, specified as a <code>rigid3d</code> object.
PointCloud	Point cloud, specified as a <code>pointCloud</code> object.

Connections — Pairwise connections between views

empty four-column table (default) | four-column table

This property is read-only.

Pairwise connections between views, specified as a four-column table. The table contains columns as described in this table. Each row corresponds to one connection.

Column	Description
ViewID1	View identifier for the first view, specified as a unique integer.
ViewID2	View identifier for the second view, specified as a unique integer.
RelativePose	Relative pose of the second view with respect to the first view, specified as a rigid3d object.
InformationMatrix	Information matrix, specified as a 6-by-6 matrix. The information matrix represents the uncertainty of the measurement error and is the inverse of the covariance matrix.

NumViews — Number of views

0 (default) | nonnegative integer

This property is read-only.

Number of views, specified as a nonnegative integer.

NumConnections — Number of connections

0 (default) | nonnegative integer

This property is read-only.

Number of connections, specified as a nonnegative integer.

Object Functions

addView	Add views to view set
updateView	Update view in view set
deleteView	Delete view from view set
hasView	Check if view is in view set
addConnection	Add connection between views in view set
updateConnection	Update connection between views in a view set
deleteConnection	Delete a connection between views in view set
hasConnection	Check if connection between two views is in view set
findView	Find views associated with view identifiers
findConnection	Find connections associated with view identifiers
connectedViews	Connected views in view set
poses	Absolute poses associated with views in view set
createPoseGraph	Create pose graph
optimizePoses	Optimize absolute poses using relative pose constraints
plot	Plot view set views and connections

Examples**Perform Lidar Odometry Using Point Cloud Registration**

Create a view set to hold odometry.

```
vSet = pcviewset;
```

Create a Velodyne reader to read point clouds.

```
veloReader = velodyneFileReader('lidarData_ConstructionRoad.pcap', 'HDL32E');
ptCloud = readFrame(veloReader);
```

Preprocess one frame to remove the ground plane and to downsample point cloud.

```
elevationDelta = 25;
gridStep       = 0.2;
groundPtsIdx = segmentGroundFromLidarData(ptCloud, ...
    'ElevationAngleDelta', elevationDelta);
ptCloud = select(ptCloud, ~groundPtsIdx, 'Output', 'full');
ptCloud = pcdsample(ptCloud, 'gridAverage', gridStep);
```

Initialize attributes for the first view.

```
absPose = rigid3d;
relPose = rigid3d;
```

Add the first view to the point cloud view set.

```
vSet = addView(vSet, 1, absPose, 'PointCloud', ptCloud);
```

Initialize a point cloud map using the first view.

```
ptCloudMap = copy(ptCloud);
```

```
skipFrames = 5;
prevViewId = 1;
prevPtCloud = ptCloud;
```

Loop over frames to update odometry and the point cloud map.

```
for viewId = 6 : skipFrames : 50
    % Read point cloud.
    ptCloud = readFrame(veloReader, viewId);

    %Preprocess the frame.
    groundPtsIdx = segmentGroundFromLidarData(ptCloud, ...
        'ElevationAngleDelta', elevationDelta);
    ptCloud = select(ptCloud, ~groundPtsIdx, 'Output', 'full');
    ptCloud = pcdsample(ptCloud, 'gridAverage', gridStep);

    % Register new point cloud against the previous one.
    regGridStep = 5;
    relPose = pcregisterndt(ptCloud, prevPtCloud, regGridStep, ...
        'InitialTransform', relPose);

    % Update the absolute transform.
    absPose = rigid3d( relPose.T*absPose.T );

    % Add new view and connection to the previous view.
    vSet = addView(vSet, viewId, absPose, 'PointCloud', ptCloud);
    vSet = addConnection(vSet, prevViewId, viewId, relPose);

    prevPtCloud = ptCloud;
    prevViewId = viewId;
end
```

Display the view set in a default 2-D view.

```
plot(vSet, 'ShowViewIds', 'on')  
view(2)
```

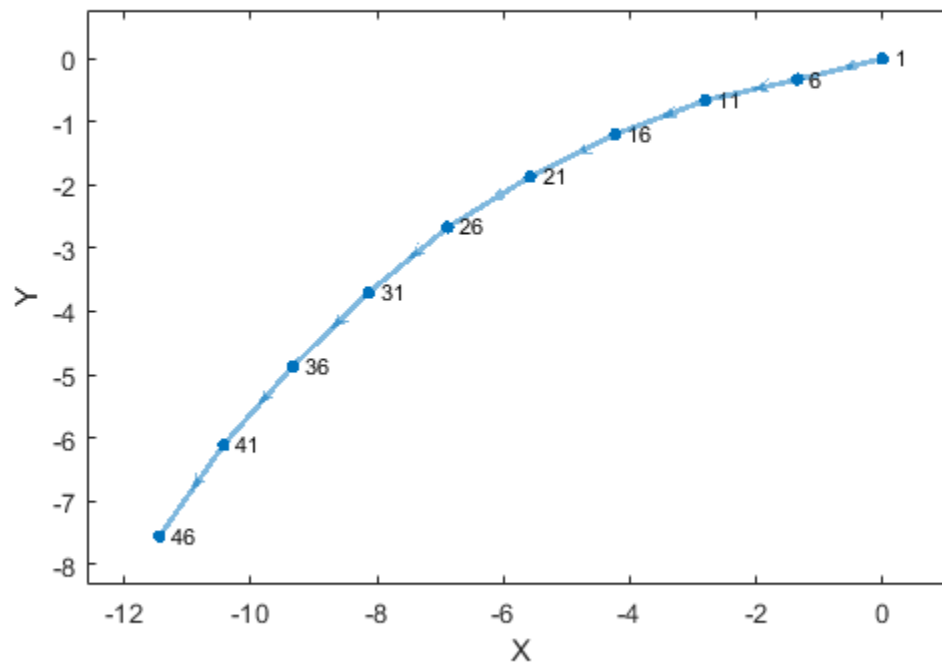

See Also

Functions

table | digraph

Topics

“Build a Map from Lidar Data Using SLAM”

Introduced in R2020a

addView

Add views to view set

Syntax

```
vSet = addView(vSet,viewId)
vSet = addView(vSet,viewId,absPose)
vSet = addView( ____, 'PointCloud',ptCloud)

vSet = addView(vSet,viewTable)
```

Description

`vSet = addView(vSet,viewId)` adds the view specified by `viewId` to the view set, `vSet`.

`vSet = addView(vSet,viewId,absPose)` specifies the absolute pose of the view.

`vSet = addView(____, 'PointCloud',ptCloud)` specifies the point cloud associated with the view in addition to any of the input argument combinations in previous syntaxes.

`vSet = addView(vSet,viewTable)` adds one or more views in the table specified by `viewTable`.

Examples

Add View To Point Cloud View Set

Create an empty point cloud view set.

```
vSet = pcviewset;
```

Create a point cloud.

```
ptCloud = pcread('teapot.ply');
```

Specify an absolute pose.

```
absPose = rigid3d(eye(3),[1 0 0]);
```

Add a view to the point cloud view set.

```
viewId = 1;
vSet = addView(vSet,viewId,absPose,'PointCloud',ptCloud);
```

Input Arguments

vSet — Point cloud view set

`pcviewset` object

Point cloud view set, specified as a `pcviewset` object.

viewId – View identifier

positive integer

View identifier, specified as an integer. View identifiers are unique to a specific view.

absPose – Absolute pose of the view

rigid3d object

Absolute pose of the view, specified as a rigid3d object.

ptCloud – Point cloud

pointCloud object

Point cloud, specified as a pointCloud object.

viewTable – One or more views

two-column table | three-column table

One or more views, specified as a two-column or three-column table. The table must contain the columns ViewId and AbsolutePose. Points column is optional.

Column	Description
ViewID	View identifier, specified as an integer. View identifiers are unique to a specific view.
AbsolutePose	Absolute pose of the view, specified as a rigid3d object.
Points	Point cloud for the view, specified as a pointCloud object.

Output Arguments**vSet – View set with added views**

pcviewset object

View set with added views, returned as a pcviewset object.

See Also**Objects**

rigid3d | pcviewset

Introduced in R2020a

updateView

Update view in view set

Syntax

```
vSet = updateView(vSet,viewId,absPose)
vSet = updateView( ____, 'PointCloud',ptCloud)

vSet = updateView(vSet,viewTable)
```

Description

`vSet = updateView(vSet,viewId,absPose)` updates the view specified by `viewId` with the absolute pose `absPose`.

`vSet = updateView(____, 'PointCloud',ptCloud)` specifies the point cloud associated with the view.

`vSet = updateView(vSet,viewTable)` updates the views specified in the table `viewTable`.

Examples

Update View in Point Cloud View Set

Create an empty point cloud view set.

```
vSet = pcviewset;
```

Add a view to the point cloud view set.

```
viewId = 1;
ptCloud = pcread('teapot.ply');

vSet = addView(vSet,viewId,'PointCloud',ptCloud);
```

Update the absolute pose of the view.

```
absPose = rigid3d(eye(3),[2 0 0]);
vSet = updateView(vSet,viewId,absPose);
```

Input Arguments

vSet — Point cloud view set

`pcviewset` object

View set, specified as an `pcviewset` object.

viewId — View identifier

integer

Point cloud view identifier, specified as a unique integer.

absPose — Absolute pose

rigid3d object

Absolute pose, specified as a rigid3d object.

ptCloud — Point cloud

pointCloud object

Point cloud, specified as a pointCloud object.

viewTable — New view or set of views

two-column table | three-column table

New view or set of views, specified as a two- or three- column table. The table must contain the columns ViewId and AbsolutePose, and an optional column, Points.

Column	Description
ViewID	View identifier for the view, specified as a unique integer
AbsolutePose	Absolute pose of the view, specified as a rigid3d object.
Points	A pointCloud.

Output Arguments

vSet — View set with updated view

pcviewset object

View set with updated view, returned as a pcviewset object.

See Also

Objects

rigid3d | pcviewset

Introduced in R2020a

deleteView

Delete view from view set

Syntax

```
vSet = deleteView(vSet,viewId)
```

Description

`vSet = deleteView(vSet,viewId)` deletes the view specified by `viewId` from the view set, `vSet`.

Examples

Delete View from Point Cloud View Set

Create an empty point cloud view set.

```
vSet = pcviewset;
```

Add two views to the point cloud view set.

```
viewId1 = 1;  
viewId2 = 2;  
ptCloud1 = pcread('teapot.ply');  
ptCloud2 = pctransform(ptCloud1,rigid3d(eye(3),[2 0 0]));
```

```
vSet = addView(vSet,viewId1,'PointCloud',ptCloud1);  
vSet = addView(vSet,viewId2,'PointCloud',ptCloud2);
```

Delete the first view.

```
vSet = deleteView(vSet,viewId1);
```

Input Arguments

vSet — Point cloud view set

`pcviewset` object

Point cloud view set, specified as a `pcviewset` object.

viewId — View identifier

positive integer

View identifier, specified as an integer. View identifiers are unique to a specific view.

Output Arguments

vSet — View set with deleted views

pcviewset object

View set with deleted views, returned as a pcviewset object.

See Also

Objects

pcviewset

Introduced in R2020a

hasView

Check if view is in view set

Syntax

```
tf = hasView(vSet,viewId)
```

Description

`tf = hasView(vSet,viewId)` returns 1 (true), if the view specified by `viewId` is in the view set, `vSet`. The function returns 0 (false), if the view is not in `vSet`.

Examples

Check If View Is in Point Cloud View Set

Create an empty point cloud view set.

```
vSet = pcviewset;
```

Add a view with ID 1 to the point cloud view set.

```
ptCloud = pcread('teapot.ply');  
vSet = addView(vSet,1,'PointCloud',ptCloud);
```

Check if a view with ID 1 is in the view set.

```
hasView(vSet,1)
```

```
ans = logical  
     1
```

Check if a view with ID 2 is in the view set.

```
hasView(vSet,2)
```

```
ans = logical  
     0
```

Input Arguments

vSet — Point cloud view set

`pcviewset` object

Point cloud view set, specified as a `pcviewset` object.

viewId — View identifier

positive integer

View identifier, specified as an integer. View identifiers are unique to a specific view.

Output Arguments

tf — True or false result

1 | 0

True or false result indicating if view is in view set `vSet`, returned as a 1 or 0 data type `logical`.

See Also

Objects

`pcviewset`

Introduced in R2020a

addConnection

Add connection between views in view set

Syntax

```
vSet = addConnection(vSet,viewId1,viewId2)
vSet = addConnection(vSet,viewId1,viewId2,relPose)
vSet = addConnection(vSet,viewId1,viewId2,relPose,infoMat)
```

Description

`vSet = addConnection(vSet,viewId1,viewId2)` adds a connection between views `viewId1` and `viewId2` to the view set, `vSet`.

`vSet = addConnection(vSet,viewId1,viewId2,relPose)` specifies the relative pose of `viewId2` with respect to `viewId1`.

`vSet = addConnection(vSet,viewId1,viewId2,relPose,infoMat)` specifies the information matrix associated with the connection.

Examples

Add Connection to Point Cloud View Set

Create an empty point cloud view set.

```
vSet = pcviewset;
```

Load point cloud data.

```
data = load('livingRoom.mat');
ptCloud1 = data.livingRoomData{1};
ptCloud2 = data.livingRoomData{2};
```

Add `ptCloud1` to the point cloud view set. Specify a `rigid3d` object as the origin.

```
absPose1 = rigid3d;
vSet = addView(vSet,1,absPose1,'PointCloud',ptCloud1);
```

Add `ptCloud2` to the point cloud view set. Specify a `rigid3d` object as the origin.

```
vSet = addView(vSet,2,absPose1,'PointCloud',ptCloud2);
```

Estimate the rigid transformation between the two point clouds.

```
ptCloud2Downsampled = pcdsample(ptCloud2,'gridAverage',0.1);
gridStep = 0.5;
relPose = pcregisterndt(ptCloud2Downsampled,ptCloud1,gridStep);
```

Add a connection between the views.

```
vSet = addConnection(vSet,1,2,relPose);
```

Compute the accumulated absolute pose.

```
absPose2 = rigid3d( absPose1.T*relPose.T );
```

Update the absolute pose of second view.

```
vSet = updateView(vSet,2,absPose2);
```

Input Arguments

vSet — Point cloud view set

pcviewset object

Point cloud view set, specified as a pcviewset object.

viewId1 — View identifier 1

positive integer

View identifier 1, specified as an integer. View identifiers are unique to a specific view.

viewId2 — View identifier 2

positive integer

View identifier 2, specified as an integer. View identifiers are unique to a specific view.

relPose — Relative pose

rigid3d object

Relative pose of viewId2 with respect to viewId1, specified as a rigid3d object.

infoMat — Information matrix

6-by-6 numeric matrix

Information matrix associated with the connection, specified as a 6-by-6 numeric matrix.

Output Arguments

vSet — View set with added connections

pcviewset object

View set with added connections between views, returned as a pcviewset object.

See Also

Objects

rigid3d | pcviewset

Introduced in R2020a

updateConnection

Update connection between views in a view set

Syntax

```
vSet = updateConnection(vSet,viewId1,viewId2,relPose)
vSet = updateConnection(vSet,viewId1,viewId2,relPose,infoMat)
```

Description

`vSet = updateConnection(vSet,viewId1,viewId2,relPose)` updates the connection between views `viewId1` and `viewId2` with the relative pose specified by `relPose`.

`vSet = updateConnection(vSet,viewId1,viewId2,relPose,infoMat)` specifies the information matrix associated with the connection.

Examples

Update Connection in Point Cloud View Set

Create an empty point cloud view set.

```
vSet = pcviewset;
```

Load point cloud data.

```
data = load('livingRoom.mat');
ptCloud1 = data.livingRoomData{1};
ptCloud2 = data.livingRoomData{2};
```

Add two views to the point cloud view set.

```
vSet = addView(vSet,1,'PointCloud',ptCloud1);
vSet = addView(vSet,2,'PointCloud',ptCloud2);
```

Add a connection between the two views.

```
vSet = addConnection(vSet,1,2);
```

Estimate the rigid transformation between the two point clouds.

```
ptCloud2Downsampled = pcdsample(ptCloud2,'gridAverage',0.1);
gridStep = 0.5;
relPose = pcregisterndt(ptCloud2Downsampled,ptCloud1,gridStep);
```

Compute the accumulated absolute pose for each view.

```
absPose1 = rigid3d;
absPose2 = rigid3d(absPose1.T*relPose.T );
```

Update the connection with relative pose between views.

```
vSet = updateConnection(vSet,1,2,relPose);
```

Update the views with the absolute poses.

```
vSet = updateView(vSet,1,absPose1);  
vSet = updateView(vSet,2,absPose2);
```

Input Arguments

vSet — Point cloud view set

pcviewset object

Point cloud view set, specified as a pcviewset object.

viewId1 — View identifier 1

positive integer

View identifier 1, specified as an integer. View identifiers are unique to a specific view.

viewId2 — View identifier 2

positive integer

View identifier 2, specified as an integer. View identifiers are unique to a specific view.

relPose — Relative pose

rigid3d object

Relative pose of viewId2 with respect to viewId1, specified as a rigid3d object.

infoMat — Information matrix

6-by-6 numeric matrix

Information matrix associated with the connection, specified as a 6-by-6 numeric matrix.

Output Arguments

vSet — View set with updated connections

pcviewset object

View set with updated connections between views, returned as a pcviewset object.

See Also

Objects

rigid3d | pcviewset

Introduced in R2020a

deleteConnection

Delete a connection between views in view set

Syntax

```
vSet = deleteConnection(vSet,viewId1,viewId2)
```

Description

`vSet = deleteConnection(vSet,viewId1,viewId2)` deletes the connection between views `viewId1` and `viewId2` in the view set, `vSet`.

Examples

Delete Connection Between Views in Point Cloud View Set

Create an empty point cloud view set.

```
vSet = pcviewset;
```

Add two views and one connection to the view set.

```
vSet = addView(vSet,1);  
vSet = addView(vSet,2);  
vSet = addConnection(vSet,1,2);
```

Delete the connection between the two views.

```
vSet = deleteConnection(vSet,1,2);
```

Input Arguments

vSet — Point cloud view set

`pcviewset` object

Point cloud view set, specified as a `pcviewset` object.

viewId1 — View identifier 1

positive integer

View identifier 1, specified as an integer. View identifiers are unique to a specific view.

viewId2 — View identifier 2

positive integer

View identifier 2, specified as an integer. View identifiers are unique to a specific view.

Output Arguments

vSet — View set with deleted connections

pcviewset object

View set with deleted connections between views, returned as a pcviewset object.

See Also

Objects

pcviewset

Introduced in R2020a

hasConnection

Check if connection between two views is in view set

Syntax

```
tf = hasConnection(vSet,viewId1,viewId2)
```

Description

`tf = hasConnection(vSet,viewId1,viewId2)` returns 1 (true), if the connection between views `viewId1` and `viewId2` is in the view set, `vSet`. The function returns 0 (false), if the connection does not exist in `vSet`.

Examples

Check for Connection Between Views in Point Cloud View Set

Create an empty point cloud view set.

```
vSet = pcviewset;
```

Add two views to the point cloud view set.

```
vSet = addView(vSet,1);  
vSet = addView(vSet,2);
```

Add a connection to the point cloud view set.

```
vSet = addConnection(vSet,1,2);
```

Check if the connection is between views is in the point cloud view set.

```
tf = hasConnection(vSet,1,2)
```

```
tf = logical  
    1
```

Input Arguments

vSet — Point cloud view set

`pcviewset` object

Point cloud view set, specified as a `pcviewset` object.

viewId1 — View identifier 1

positive integer

View identifier 1, specified as an integer. View identifiers are unique to a specific view.

viewId2 — View identifier 2

positive integer

View identifier 2, specified as an integer. View identifiers are unique to a specific view.

Output Arguments**tf — True or false result**

1 | 0

True or false result indicating if the connection between views `viewId1` and `viewId2` exists in view set `vSet`, returned as a 1 or 0 data type `logical`.

See Also**Objects**

pcviewset

Introduced in R2020a

connectedViews

Connected views in view set

Syntax

```
viewTable = connectedViews(vSet,viewId)
```

Description

`viewTable = connectedViews(vSet,viewId)` returns a table of views from `vSet` that are connected to the view specified by `viewId`.

Examples

Get Connected Views in View Set

Create an empty point cloud view set object.

```
vSet = pcviewset;
```

Add views to the point cloud view set.

```
vSet = addView(vSet,1);
vSet = addView(vSet,2);
vSet = addView(vSet,3);
vSet = addView(vSet,4);
```

Connect views in the point cloud view set.

```
vSet = addConnection(vSet,1,2);
vSet = addConnection(vSet,2,3);
vSet = addConnection(vSet,2,4);
```

Get the connected views for the view with ID 2.

```
viewTable = connectedViews(vSet,2)
```

```
viewTable=3x3 table
  ViewId  AbsolutePose  PointCloud
  -----  -----  -----
      1      1x1 rigid3d    1x1 pointCloud
      3      1x1 rigid3d    1x1 pointCloud
      4      1x1 rigid3d    1x1 pointCloud
```

Input Arguments

vSet — Point cloud view set

pcviewset object

Point cloud view set, specified as a `pcviewset` object.

viewId – View identifier

positive integer

View identifier, specified as an integer. View identifiers are unique to a specific view.

Output Arguments

viewTable – One or more views

two-column table | three-column table

One or more views, returned as a three-column table. The table must contain the columns as described in this table.

Column	Description
ViewID	View identifier, specified as an integer. View identifiers are unique to a specific view.
AbsolutePose	Absolute pose of the view, specified as a <code>rigid3d</code> object.
Points	Point cloud for the view, specified as a <code>pointCloud</code> object.

See Also

Objects

`pcviewset` | `rigid3d`

Introduced in R2020a

poses

Absolute poses associated with views in view set

Syntax

```
sensorPoses = poses(vSet)
```

Description

`sensorPoses = poses(vSet)` returns a table of absolute poses associated with the views contained in the view set, `vSet`.

Examples

Get Absolute Poses from Point Cloud View Set

Create an empty point cloud view set.

```
vSet = pcviewset;
```

Load point cloud data.

```
data = load('livingRoom.mat');  
ptCloud1 = data.livingRoomData{1};  
ptCloud2 = data.livingRoomData{2};
```

Add `ptCloud1` to the view set.

```
absPose1 = rigid3d;  
vSet = addView(vSet,1,absPose1,'PointCloud',ptCloud1);
```

Add `ptCloud2` to the view set.

```
vSet = addView(vSet,2,'PointCloud',ptCloud2);
```

Estimate the rigid transformation between the two point clouds.

```
ptCloud2Downsampled = pcdsample(ptCloud2,'gridAverage',0.1);  
gridStep = 0.5;  
relPose = pcregisterndt(ptCloud2Downsampled,ptCloud1,gridStep);
```

Add a connection between the two views.

```
vSet = addConnection(vSet,1,2,relPose);
```

Compute the accumulated absolute pose.

```
absPose2 = rigid3d(absPose1.T*relPose.T );
```

Update the absolute pose of second view.

```
vSet = updateView(vSet,2,absPose2);
```

Get absolute poses.

```
sensorPoses = poses(vSet)
```

```
sensorPoses=2x2 table
  ViewId AbsolutePose
  _____
      1      1x1 rigid3d
      2      1x1 rigid3d
```

Input Arguments

vSet — Point cloud view set

pcviewset object

Point cloud view set, specified as a pcviewset object.

Output Arguments

sensorPoses — Absolute poses

two-column table

Absolute poses, returned as a two-column table. The table contains columns as described in this table.

Column	Description
ViewID	View identifier, returned as a positive integer. View identifiers are unique to a specific view.
AbsolutePose	Absolute pose of the view, specified as a rigid3d object.

See Also

Objects

pcviewset | rigid3d

Introduced in R2020a

optimizePoses

Optimize absolute poses using relative pose constraints

Syntax

```
vSetOptim = optimizePoses(vSet)
vSetOptim = optimizePoses(vSet,Name,Value)
```

Description

`vSetOptim = optimizePoses(vSet)` returns a point cloud view set whose absolute poses are optimized. `vSetOptim` and `vSet` are `pcviewset` objects.

The `optimizePoses` function performs pose graph optimization on the absolute poses for the `Views` in the view set using the relative pose constraints established by the `Connections` property. You can use `optimizePoses` to correct drift in odometry after detecting loop closures.

`vSetOptim = optimizePoses(vSet,Name,Value)` specifies options using one or more name-value pair arguments. For example, `'Tolerance',0.2` sets the tolerance of the optimization cost function to 0.2.

Examples

Create and Optimize Poses Using Point Cloud View Set

Create a view set.

```
vSet = pcviewset;
```

Add four nodes and specify absolute poses.

```
absPoses = repelem(rigid3d, 4, 1);

absPoses(1).Translation = [ 0  0 0];
absPoses(2).Translation = [ 1  0 0];
absPoses(3).Translation = [ 2  0 0];
absPoses(4).Translation = [ 0.1 0 0];
```

```
vSet = addView(vSet, 1, absPoses(1));
vSet = addView(vSet, 2, absPoses(2));
vSet = addView(vSet, 3, absPoses(3));
vSet = addView(vSet, 4, absPoses(4));
```

Define 4 edges, 3 odometry and 1 loop closure.

```
relPoses = repelem(rigid3d, 4, 1);

relPoses(1).Translation = [ 1  0 0];
relPoses(2).Translation = [ 1  0 0];
relPoses(3).Translation = [-1.9 0 0];
relPoses(4).Translation = [ 0.2 0 0];
```



```
vSet = addConnection(vSet, 1, 2, relPoses(1)); % odometry
vSet = addConnection(vSet, 2, 3, relPoses(2)); % odometry
vSet = addConnection(vSet, 3, 4, relPoses(3)); % odometry
vSet = addConnection(vSet, 4, 1, relPoses(4)); % loop closure
```

Optimize view set.

```
vSetOptim = optimizePoses(vSet);
```

Display original and optimized locations.

```
disp('Original absolute translations:')
```

Original absolute translations:

```
disp(vertcat(vSet.Views.AbsolutePose.Translation))
```

```

      0      0      0
  1.0000      0      0
  2.0000      0      0
  0.1000      0      0
```

```
disp('Optimized absolute translations:')
```

Optimized absolute translations:

```
disp(vertcat(vSetOptim.Views.AbsolutePose.Translation))
```

```

      0      0      0
  0.9250      0      0
  1.8500      0      0
 -0.1250      0      0
```

Input Arguments

vSet — Point cloud view set

pcviewset object

Point cloud view set, specified as a pcviewset object.

Name-Value Pair Arguments

Specify optional comma-separated pairs of **Name**, **Value** arguments. **Name** is the argument name and **Value** is the corresponding value. **Name** must appear inside quotes. You can specify several name and value pair arguments in any order as **Name1**, **Value1**, ..., **NameN**, **ValueN**.

Example: 'MaxIterations',300 sets the maximum number of iterations to 300.

MaxIterations — Maximum number of iterations

300 (default) | positive integer

Maximum number of iterations before the function terminates optimization, specified as the comma-separated pair consisting of 'MaxIterations' and a positive integer. Increase this value for greater accuracy in the results. Decrease this value for faster results.

Tolerance — Tolerance of optimization cost function`1e-8` (default) | positive scalar

Tolerance of the optimization cost function between two consecutive iterations, specified as the comma-separated pair consisting of 'Tolerance' and a positive scalar. If the cost function changes by less than the 'Tolerance' value between two consecutive iterations, the function terminates optimization.

Verbose — Display progress information`false` or `0` (default) | `true` or `1`

Display progress information, specified as the comma-separated pair consisting of `Verbose` and a numeric or logical `0` (`false`) or `1` (`true`). To display the progress information, set 'Verbose' to `true`.

Output Arguments**vSetOptim — Optimized absolute poses**`pcviewset` object

Point cloud view set that contains optimized absolute poses, specified as a `pcviewset` object.

Tips

- To update a view set with optimized poses, use the `updateView` object function.
- The `optimizePoses` object function holds the first view fixed.

Algorithms

The `optimizePoses` function uses the Levenberg-Marquardt optimization algorithm with sparse Cholesky decomposition from the general (hyper) graph optimization (G2o) library, [1 on page 2-174].

References

- [1] Kümmerle, Rainer, Giorgio Grisetti, Hauke Strasdat, Kurt Konolige, and Wolfram Burgard. "G2o: A General Framework for Graph Optimization." In *2011 IEEE International Conference on Robotics and Automation*, 3607-13, 2011. <https://doi.org/10.1109/ICRA.2011.5979949>.

See Also**Functions**`createPoseGraph`**Objects**`imageviewset` | `pcviewset`**Introduced in R2020a**

createPoseGraph

Create pose graph

Syntax

```
G = createPoseGraph(vSet)
```

Description

`G = createPoseGraph(vSet)` returns a pose graph derived from the views and connections in the view set, `vSet`.

Examples

Create Pose Graph from Point Cloud View Set

Create an empty point cloud view set.

```
vSet = pcviewset;
```

Define three relative poses.

```
relPoses = repelem(rigid3d,3,1);
relPoses(1).Translation = [3 0 0];
relPoses(2).Translation = [5 0 0];
relPoses(3).Translation = [2 0 0]
```

```
relPoses =
    3x1 rigid3d array with properties:
```

```
    Dimensionality
    T
    Rotation
    Translation
```

Accumulate absolute poses.

```
absPoses = repelem(rigid3d,4,1);
absPoses(2).T = relPoses(1).T*absPoses(1).T;
absPoses(3).T = relPoses(2).T*absPoses(2).T;
absPoses(4).T = relPoses(3).T*absPoses(3).T;
```

Add four views to the point cloud view set.

```
vSet = addView(vSet,1,absPoses(1));
vSet = addView(vSet,2,absPoses(2));
vSet = addView(vSet,3,absPoses(3));
vSet = addView(vSet,4,absPoses(4));
```

Add three connections to the point cloud view set.

```
vSet = addConnection(vSet,1,2,relPoses(1));  
vSet = addConnection(vSet,2,3,relPoses(2));  
vSet = addConnection(vSet,3,4,relPoses(3));
```

Add a loop closure connection to the point cloud view set.

```
relPoses(4).Translation = [9 0 0];  
vSet = addConnection(vSet,4,1,relPoses(4));
```

Create a pose graph.

```
G = createPoseGraph(vSet);
```

Input Arguments

vSet — View set

`pcviewset` object

View set, specified as a `pcviewset` object.

Output Arguments

G — Pose graph

`digraph` object

Pose graph, returned as a `digraph` object. The nodes in the object correspond to views, and the edges in the object correspond to connections.

The `EndNodes` of the Edges in the `G` digraph correspond to indices into the `Views` table, (not `ViewIds`).

Tips

- The `EndNodes` of the Edges in the `G` digraph correspond to indices into the `Views` table, (not `ViewIds`).
- Use “Directed and Undirected Graphs” to inspect, modify, or visualize the pose graph.
- Use the `optimizePoseGraph` function to optimize the pose graph. Use of this function requires the Navigation Toolbox™.

See Also

Functions

`digraph` | `optimizePoses` | `optimizePoseGraph`

Objects

`pcviewset`

Introduced in R2020a

findView

Find views associated with view identifiers

Syntax

```
views = findView(vSet,viewIds)
```

Description

`views = findView(vSet,viewIds)` returns a table containing view attributes that correspond to the view identifiers in `viewIds`.

Examples

Find View Corresponding to View ID

Create an empty point cloud view set.

```
vSet = pcviewset;
```

Add two views to the view set.

```
viewId1 = 10;
viewId2 = 5;
ptCloud1 = pcread("teapot.ply");
ptCloud2 = pctransform(ptCloud1,rigid3d(eye(3),[2 0 0]));
vSet = addView(vSet,viewId1,PointCloud=ptCloud1);
vSet = addView(vSet,viewId2,PointCloud=ptCloud2);
```

Find the view associated with the view identifier 5, and then display the view table.

```
view = findView(vSet,5);
disp(view)
```

ViewId	AbsolutePose	PointCloud
5	1x1 rigid3d	1x1 pointCloud

Get the point cloud that corresponds to view identifier 5.

```
ptCloud = view.PointCloud;
```

Get the absolute pose associated with view identifier 5.

```
absPose = view.AbsolutePose;
```

Input Arguments

vSet — Point cloud view set

pcviewset object

Point cloud view set, specified as a *pcviewset* object.

viewIds — View identifier

M-element vector

View identifiers, specified as an *M*-element vector of integers. View identifiers are unique to a specific view.

Output Arguments

views — Table containing view attributes

three-column table

Table containing view attributes, specified as a three-column table. The table contains the columns `ViewId`, `AbsolutePose`, and `pointCloud` attribute descriptions.

See Also

Objects

pcviewset

Introduced in R2021b

findConnection

Find connections associated with view identifiers

Syntax

```
conn = findConnection(vSet,viewIds1,viewIds2)
```

Description

`conn = findConnection(vSet,viewIds1,viewIds2)` returns a table containing connection attributes for connections between `viewIds1` and `viewIds2`. `viewIds1` and `viewIds2` are *M*-element vectors of view identifiers.

Examples

Find Connection and Relative Pose Between Two Views

Create an empty point cloud view set.

```
vSet = pcviewset;
```

Add two views to the view set.

```
viewId1 = 10;
viewId2 = 5;
vSet = addView(vSet,viewId1);
vSet = addView(vSet,viewId2);
```

Add a connection between `viewId1` and `viewId2`.

```
vSet = addConnection(vSet,viewId1,viewId2);
```

Find and display the connection between `viewId1` and `viewId2`.

```
conn = findConnection(vSet,viewId1,viewId2);
disp(conn)
```

<u>ViewId1</u>	<u>ViewId2</u>	<u>RelativePose</u>	<u>InformationMatrix</u>
10	5	1x1 rigid3d	{6x6 double}

Get the relative pose between `viewId1` and `viewId2`.

```
relPose = conn.RelativePose;
```

Input Arguments

vSet — Point cloud view set

pcviewset object

Point cloud view set, specified as a `pcviewset` object.

viewIds1 – View identifiers

M-element vector

View identifiers, specified as an *M*-element vector of integers. View identifiers are unique to a specific view.

viewIds2 – View identifiers

M-element vector

View identifiers, specified as an *M*-element vector of integers. View identifiers are unique to a specific view.

Output Arguments

conn – Table containing connection attributes

four-column table

Table containing view attributes, specified as a four-column table. The table contains the columns `ViewId1`, `ViewId2`, `RelativePose`, and `InformationMatrix` attribute descriptions.

See Also

Objects

`pcviewset`

Introduced in R2021b

imageviewset

Manage data for structure-from-motion, visual odometry, and visual SLAM

Description

The `imageviewset` object manages view attributes and pairwise connections between views of data used in structure-from-motion, visual odometry, and simultaneous localization and mapping (SLAM) data. View attributes can be feature descriptors, feature points, or absolute camera poses. Pairwise connections between views can be point matches, relative camera poses, or an information matrix. You can also use this object to find point tracks used by `triangulateMultiview` and `bundleAdjustment` functions.

Creation

Syntax

```
vSet = imageviewset()
```

Description

`vSet = imageviewset()` returns an `imageviewset` object. You can add views and connections using the `addView` and `addConnection` object functions.

Properties

Views — View attributes

empty three-column table (default) | three-column table

This property is read-only.

View attributes, specified as a three-column table. The table contains columns as described in this table.

Column	Description
ViewId	View identifier for the view, specified as a unique integer
AbsolutePose	Absolute pose of the view, specified as a <code>rigid3d</code> object.
Features	Feature vectors, specified as an M -by- N matrix of M feature vectors or as a <code>binaryFeatures</code> .

Column	Description
Points	Image points, specified as one of these options: <ul style="list-style-type: none"> M-by-2 matrix of coordinates in the format $[x,y]$ M-element feature point array. For more details, see "Point Feature Types".

Connections – Pairwise connections between views

empty four-column table (default) | four-column table

This property is read-only.

Pairwise connections between views, specified as a four-column table. The table contains columns as described in this table. Each row corresponds to one connection.

Column	Description
ViewId1	View identifier for the first view, specified as a unique integer.
ViewId2	View identifier for the second view, specified as a unique integer.
RelativePose	Relative pose of the second view with respect to the first view, specified as a <code>rigid3d</code> or an <code>affine3d</code> object. When you specify an <code>affine3d</code> object, the relative pose must represent a 3-D similarity transformation.
InformationMatrix	Information matrix, specified as a 6-by-6 matrix when you specify the <code>RelativePose</code> as a <code>rigid3d</code> object. When you specify <code>RelativePose</code> as an <code>affine3d</code> object, <code>InformationMatrix</code> must be a 7-by-7 matrix. The information matrix represents the uncertainty of the measurement error and is the inverse of the covariance matrix.
Matches	Indices of matched feature points between two views, specified as M -by-2 matrix.

NumViews – Number of views

0 (default) | nonnegative integer

This property is read-only.

Number of views, specified as a nonnegative integer.

NumConnections – Number of connections

0 (default) | nonnegative integer

This property is read-only.

Number of connections, specified as a nonnegative integer.

Object Functions

addView	Add views to view set
updateView	Update view in view set
deleteView	Delete view from view set
hasView	Check if view is in view set
addConnection	Add connection between views in view set
updateConnection	Update connection between views in a view set
deleteConnection	Delete a connection between views in view set
hasConnection	Check if connection between two views is in view set
findView	Find views associated with view identifiers
findConnection	Find connections associated with view identifiers
connectedViews	Return connected views
poses	Absolute poses associated with views in view set
createPoseGraph	Create pose graph
findTracks	Find matched points across multiple views
optimizePoses	Optimize absolute poses using relative pose constraints
plot	Plot view set views and connections

Examples

Find Point Tracks Across Sequence of Images

Load images in the workspace.

```
imageDir = fullfile(toolboxdir('vision'),'visiondata','structureFromMotion');
images = imageDatastore(imageDir);
```

Compute features for the first image.

```
I = im2gray(readimage(images,1));
pointsPrev = detectSURFFeatures(I);
[featuresPrev,pointsPrev] = extractFeatures(I,pointsPrev);
```

Create an image view set and add one view to the set.

```
vSet = imageviewset;
vSet = addView(vSet,1,'Features',featuresPrev,'Points',pointsPrev);
```

Compute features and matches for the rest of the images.

```
for i = 2:numel(images.Files)
    I = im2gray(readimage(images, i));
    points = detectSURFFeatures(I);
    [features, points] = extractFeatures(I,points);
    vSet = addView(vSet,i,'Features',features,'Points',points);
    pairsIdx = matchFeatures(featuresPrev,features);
    vSet = addConnection(vSet,i-1,i,'Matches',pairsIdx);
    featuresPrev = features;
end
```

Find point tracks across views in the image view set.

```
tracks = findTracks(vSet);
```

See Also

Functions

digraph | table | matchFeatures | optimizePoses | triangulateMultiview | bundleAdjustment

Objects

rigid3d | worldpointset | pcviewset | affine3d

Topics

“Implement Visual SLAM in MATLAB”

“Monocular Visual Simultaneous Localization and Mapping”

Introduced in R2020a

addView

Add views to view set

Syntax

```
vSet = addView(vSet,viewId)
vSet = addView(vSet,viewId,absPose)
vSet = addView( ____,Name,Value)
vSet = addView(vSet,viewTable)
```

Description

`vSet = addView(vSet,viewId)` adds the view specified by `viewId` to the view set, `vSet`.

`vSet = addView(vSet,viewId,absPose)` specifies the absolute pose of the view.

`vSet = addView(____,Name,Value)` specifies options using one or more name-value pair arguments in addition to any of the input argument combinations in previous syntaxes.

`vSet = addView(vSet,viewTable)` adds one or more views in the table specified by `viewTable`.

Examples

Add View to Image View Set

Create an empty image view set.

```
vSet = imageviewset;
```

Detect interest points in the image.

```
imageDir = fullfile(toolboxdir('vision'),'visiondata','structureFromMotion');
I = imread(fullfile(imageDir,'image1.jpg'));
points = detectSURFFeatures(im2gray(I));
```

Add the interest points as a view to the image view set.

```
vSet = addView(vSet,1,'Points',points);
```

Input Arguments

vSet — Image view set

`imageviewset` object

Image view set, specified as an `imageviewset` object.

viewId — View identifier

positive integer

View identifier, specified as an integer. View identifiers are unique to a specific view.

absPose — Absolute pose of the view

`rigid3d` object

Absolute pose of the view, specified as a `rigid3d` object.

viewTable — One or more views

two-column table | three-column table

One or more views, specified as a two-column or three-column table. The table must contain the columns `ViewId` and `AbsolutePose`. `Points` column is optional.

Column	Description
<code>ViewID</code>	View identifier, specified as an integer. View identifiers are unique to a specific view.
<code>AbsolutePose</code>	Absolute pose of the view, specified as a <code>rigid3d</code> object.
<code>Points</code>	Point cloud for the view, specified as a <code>pointCloud</code> object.

Name-Value Pair Arguments

Specify optional comma-separated pairs of `Name`, `Value` arguments. `Name` is the argument name and `Value` is the corresponding value. `Name` must appear inside quotes. You can specify several name and value pair arguments in any order as `Name1, Value1, . . . , NameN, ValueN`.

Example: `'Points', detectSURFFeatures(rgb2gray(i))`

Features — Feature vectors

M -by- N matrix | `binaryFeatures` object

Feature vectors, specified as the comma-separated pair consisting of `'Features'` and an M -by- N matrix of M feature vectors or as a `binaryFeatures` object.

Points — Image points

M -by-2 matrix | M -element feature point array

Image points, specified as the comma-separated pair consisting of `'Points'` and an M -by-2 matrix of coordinates in the format `[x,y]` or an M -element feature point array. For more details, see “Point Feature Types”.

Output Arguments

vSet — View set with added views

`imageviewset` object

View set with added views, returned as an `imageviewset` object.

See Also

Functions

[detectSURFFeatures](#) | [detectMinEigenFeatures](#) | [detectHarrisFeatures](#) | [detectMSERFeatures](#) | [detectFASTFeatures](#) | [detectBRISKFeatures](#) | [matchFeatures](#) | [bundleAdjustment](#) | [triangulateMultiview](#)

Objects

[rigid3d](#) | [imageviewset](#)

Introduced in R2020a

updateView

Update view in view set

Syntax

```
vSet = updateView(vSet,viewId,absPose)
vSet = updateView( ____, 'PointCloud',ptCloud)

vSet = updateView(vSet,viewTable)
```

Description

`vSet = updateView(vSet,viewId,absPose)` updates the view specified by `viewId` with the absolute pose `absPose`.

`vSet = updateView(____, 'PointCloud',ptCloud)` specifies the point cloud associated with the view.

`vSet = updateView(vSet,viewTable)` updates the views specified in the table `viewTable`.

Examples

Update View in Image View Set

Create an empty image view set.

```
vSet = imageviewset;
```

Detect interest points in an image.

```
imageDir= fullfile(toolboxdir('vision'),'visiondata','structureFromMotion');
I = imread(fullfile(imageDir,'image1.jpg'));
points = detectSURFFeatures(rgb2gray(I));
```

Add a view to the image view set.

```
vSet = addView(vSet,1,'Points',points);
```

Update the absolute pose of the view.

```
absPose = rigid3d(eye(3),[0 0 1]);
vSet = updateView(vSet,1,absPose);
```

Input Arguments

vSet — Image view set

`imageviewset` object

Image view set, specified as an `imageviewset` object.

viewId — View identifier

integer

Point cloud view identifier, specified as a unique integer.

absPose — Absolute pose

rigid3d object

Absolute pose, specified as a rigid3d object.

ptCloud — Point cloud

pointCloud object

Point cloud, specified as a pointCloud object.

viewTable — New view or set of views

two-column table | three-column table

New view or set of views, specified as a two- or three- column table. The table must contain the columns ViewId and AbsolutePose, and an optional column, Points.

Column	Description
ViewID	View identifier for the view, specified as a unique integer
AbsolutePose	Absolute pose of the view, specified as a rigid3d object.
Points	A pointCloud.

Name-Value Pair Arguments

Specify optional comma-separated pairs of Name, Value arguments. Name is the argument name and Value is the corresponding value. Name must appear inside quotes. You can specify several name and value pair arguments in any order as Name1, Value1, . . . , NameN, ValueN.

Example: 'Points', detectSURFFeatures(rgb2gray(i))

Features — Feature vectors M -by- N matrix | binaryFeatures object

Feature vectors, specified as the comma-separated pair consisting of 'Features' and an M -by- N matrix of M feature vectors or as a binaryFeatures object.

Points — Image points M -by-2 matrix | M -element feature point array

Image points, specified as the comma-separated pair consisting of 'Points' and an M -by-2 matrix of coordinates in the format $[x,y]$ or an M -element feature point array. For more details, see “Point Feature Types”.

Output Arguments**vSet — View set with updated view**

imageviewset object

View set with updated view, returned as an `imageviewset` object.

See Also

Functions

`detectSURFFeatures` | `detectMinEigenFeatures` | `detectHarrisFeatures` |
`detectMSERFeatures` | `detectFASTFeatures` | `detectBRISKFeatures` | `matchFeatures` |
`bundleAdjustment` | `triangulateMultiview`

Objects

`rigid3d` | `imageviewset`

Introduced in R2020a

deleteView

Delete view from view set

Syntax

```
vSet = deleteView(vSet,viewId)
```

Description

`vSet = deleteView(vSet,viewId)` deletes the view specified by `viewId` from the view set, `vSet`.

Examples

Delete View from Image View Set

Create an empty image view set.

```
vSet = imageviewset;
```

Detect interest points in an image.

```
imageDir = fullfile(toolboxdir('vision'),'visiondata','structureFromMotion');  
I = imread(fullfile(imageDir,'image1.jpg'));  
points = detectSURFFeatures(im2gray(I));
```

Add a view to the image view set.

```
vSet = addView(vSet,1,'Points',points);
```

Delete the view

```
vSet = deleteView(vSet,1);
```

Input Arguments

vSet — Image view set

imageviewset object

Image view set, specified as an `imageviewset` object.

viewId — View identifier

positive integer

View identifier, specified as an integer. View identifiers are unique to a specific view.

Output Arguments

vSet — View set with deleted views

imageviewset object

View set with deleted views, returned as an imageviewset object.

See Also

Objects

imageviewset

Introduced in R2020a

hasView

Check if view is in view set

Syntax

```
tf = hasView(vSet,viewId)
```

Description

`tf = hasView(vSet,viewId)` returns 1 (true), if the view specified by `viewId` is in the view set, `vSet`. The function returns 0 (false), if the view is not in `vSet`.

Examples

Check If View Is in Image View Set

Create an empty image view set.

```
vSet = imageviewset;
```

Detect interest points in an image.

```
imageDir = fullfile(toolboxdir('vision'),'visiondata','structureFromMotion');
I = imread(fullfile(imageDir, 'image1.jpg'));
points = detectSURFFeatures(im2gray(I));
```

Add a view with ID 1 to the image view set.

```
vSet = addView(vSet,1,'Points',points);
```

Check if a view with ID 1 is in the view set.

```
hasView(vSet,1)
```

```
ans = logical
      1
```

Check if a view with ID 2 is in the view set.

```
hasView(vSet,2)
```

```
ans = logical
      0
```

Input Arguments

vSet — Image view set

imageviewset object

Image view set, specified as an `imageviewset` object.

viewId – View identifier

positive integer

View identifier, specified as an integer. View identifiers are unique to a specific view.

Output Arguments**tf – True or false result**

1 | 0

True or false result indicating if view is in view set `vSet`, returned as a 1 or 0 data type `logical`.

See Also**Objects**

`imageviewset`

Introduced in R2020a

addConnection

Add connection between views in view set

Syntax

```
vSet = addConnection(vSet,viewId1,viewId2)
vSet = addConnection(vSet,viewId1,viewId2,relPose)
vSet = addConnection(vSet,viewId1,viewId2,relPose,infoMat)
vSet = addConnection( ___, 'Matches', featureMatches)
```

Description

`vSet = addConnection(vSet,viewId1,viewId2)` adds a connection between views `viewId1` and `viewId2` to the view set, `vSet`.

`vSet = addConnection(vSet,viewId1,viewId2,relPose)` specifies the relative pose of `viewId2` with respect to `viewId1`.

`vSet = addConnection(vSet,viewId1,viewId2,relPose,infoMat)` specifies the information matrix associated with the connection.

`vSet = addConnection(___, 'Matches', featureMatches)` specifies the indices of matched points between two views in addition to any of the input argument combinations in previous syntaxes.

Examples

Add Connection to Image View Set

Create an empty image view set.

```
vSet = imageviewset;
```

Read two images into the workspace.

```
imageDir = fullfile(toolboxdir('vision'),'visiondata', ...
    'structureFromMotion');
I1 = im2gray(imread(fullfile(imageDir,'image1.jpg')));
I2 = im2gray(imread(fullfile(imageDir,'image2.jpg')));
```

Detect interest points in each image.

```
points1 = detectSURFFeatures(I1);
points2 = detectSURFFeatures(I2);
```

Extract feature descriptors from the interest points.

```
[features1,validPoints1] = extractFeatures(I1,points1);
[features2,validPoints2] = extractFeatures(I2,points2);
```

Add the features and points for the two images to the image view set.

```
vSet = addView(vSet,1,'Features',features1,'Points',validPoints1);  
vSet = addView(vSet,2,'Features',features2,'Points',validPoints2);
```

Match the features between the two images.

```
indexPairs = matchFeatures(features1,features2);
```

Store the matched features as a connection in the image view set.

```
vSet = addConnection(vSet,1,2,'Matches',indexPairs);
```

Input Arguments

vSet — Image view set

imageviewset object

Image view set, specified as an imageviewset object.

viewId1 — View identifier 1

positive integer

View identifier 1, specified as an integer. View identifiers are unique to a specific view.

viewId2 — View identifier 2

positive integer

View identifier 2, specified as an integer. View identifiers are unique to a specific view.

relPose — Relative pose

rigid3d object | affine3d object

Relative pose of viewId2 with respect to viewId1, specified as a rigid3d or an affine3d object.

infoMat — Information matrix

6-by-6 numeric matrix

Information matrix associated with the connection, specified as a 6-by-6 numeric matrix.

featureMatches — Indices of matched points between two views

M -by-2 matrix

Indices of matched points between two views, specified as an M -by-2 matrix.

Output Arguments

vSet — View set with added connections

imageviewset object

View set with added connections between views, returned as an imageviewset object.

See Also

Functions

[detectSURFFeatures](#) | [detectMinEigenFeatures](#) | [detectHarrisFeatures](#) | [detectMSERFeatures](#) | [detectFASTFeatures](#) | [detectBRISKFeatures](#) | [matchFeatures](#) | [bundleAdjustment](#) | [triangulateMultiview](#)

Objects

[rigid3d](#) | [imageviewset](#)

Introduced in R2020a

updateConnection

Update connection between views in a view set

Syntax

```
vSet = updateConnection(vSet,viewId1,viewId2,relPose)
vSet = updateConnection(vSet,viewId1,viewId2,relPose,infoMat)
vSet = addConnection( ____, 'Matches', featureMatches)
```

Description

`vSet = updateConnection(vSet,viewId1,viewId2,relPose)` updates the connection between views `viewId1` and `viewId2` with the relative pose specified by `relPose`.

`vSet = updateConnection(vSet,viewId1,viewId2,relPose,infoMat)` specifies the information matrix associated with the connection.

`vSet = addConnection(____, 'Matches', featureMatches)` specifies the indices of matched points between two views in addition to any of the input argument combinations in previous syntaxes.

Examples

Update Connection in Image View Set

Create an empty image view set.

```
vSet = imageviewset;
```

Read two images into the workspace.

```
imageDir= fullfile(toolboxdir('vision'),'visiondata','structureFromMotion');
I1 = rgb2gray(imread(fullfile(imageDir,'image1.jpg')));
I2 = rgb2gray(imread(fullfile(imageDir,'image2.jpg')));
```

Detect interest points in each image.

```
points1 = detectSURFFeatures(I1);
points2 = detectSURFFeatures(I2);
```

Extract feature descriptors from the interest points.

```
[features1,validPoints1] = extractFeatures(I1,points1);
[features2,validPoints2] = extractFeatures(I2,points2);
```

Add features and the points for the two images to the image view set.

```
vSet = addView(vSet,1,'Features',features1,'Points',validPoints1);
vSet = addView(vSet,2,'Features',features2,'Points',validPoints2);
```

Match the features between the two images. Then, store the matched features as a connection in the image view set.

```
indexPairs = matchFeatures(features1,features2);
vSet = addConnection(vSet,1,2,'Matches',indexPairs);
```

Create a relative pose between the views. Then,update the connection in the image view set.

```
theta = 30; % degrees
rot = [ cosd(theta) sind(theta) 0; ...
        -sind(theta) cosd(theta) 0; ...
        0 0 1];

trans = [2 3 4];
tform = rigid3d(rot,trans);
vSet = updateConnection(vSet,1,2,tform);
```

Input Arguments

vSet — Image view set

imageviewset object

Image view set, specified as an imageviewset object.

viewId1 — View identifier 1

positive integer

View identifier 1, specified as an integer. View identifiers are unique to a specific view.

viewId2 — View identifier 2

positive integer

View identifier 2, specified as an integer. View identifiers are unique to a specific view.

relPose — Relative pose

rigid3d object | affine3d object

Relative pose of viewId2 with respect to viewId1, specified as a rigid3d or an affine3d object.

infoMat — Information matrix

6-by-6 numeric matrix

Information matrix associated with the connection, specified as a 6-by-6 numeric matrix.

featureMatches — Indices of matched points between two views

M -by-2 matrix

Indices of matched points between two views, specified as an M -by-2 matrix.

Output Arguments

vSet — View set with updated connections

imageviewset object

View set with updated connections, returned as an imageviewset object.

See Also

Functions

[detectSURFFeatures](#) | [detectMinEigenFeatures](#) | [detectHarrisFeatures](#) | [detectMSERFeatures](#) | [detectFASTFeatures](#) | [detectBRISKFeatures](#) | [matchFeatures](#) | [bundleAdjustment](#) | [triangulateMultiview](#)

Objects

[rigid3d](#) | [imageviewset](#)

Introduced in R2020a

deleteConnection

Delete a connection between views in view set

Syntax

```
vSet = deleteConnection(vSet,viewId1,viewId2)
```

Description

`vSet = deleteConnection(vSet,viewId1,viewId2)` deletes the connection between views `viewId1` and `viewId2` in the view set, `vSet`.

Examples

Delete Connection Between Views in Image View Set

Create an empty image view set.

```
vSet = imageviewset;
```

Read two images into the workspace.

```
imageDir = fullfile(toolboxdir('vision'),'visiondata','structureFromMotion');
I1 = im2gray(imread(fullfile(imageDir,'image1.jpg')));
I2 = im2gray(imread(fullfile(imageDir,'image2.jpg')));
```

Detect interest points in each image.

```
points1 = detectSURFFeatures(I1);
points2 = detectSURFFeatures(I2);
```

Extract feature descriptors from the interest points.

```
[features1,validPoints1] = extractFeatures(I1,points1);
[features2,validPoints2] = extractFeatures(I2,points2);
```

Add the features and points for the two images to the image view set.

```
vSet = addView(vSet,1,'Features',features1,'Points',validPoints1);
vSet = addView(vSet,2,'Features',features2,'Points',validPoints2);
```

Match the features between the two images. Then, store the matches features as a connection in the image view set.

```
indexPairs = matchFeatures(features1,features2);
vSet = addConnection(vSet,1,2,'Matches',indexPairs);
```

Delete the connection between the two views.

```
vSet = deleteConnection(vSet,1,2);
```

Input Arguments

vSet — Image view set

`imageviewset` object

Image view set, specified as an `imageviewset` object.

viewId1 — View identifier 1

positive integer

View identifier 1, specified as an integer. View identifiers are unique to a specific view.

viewId2 — View identifier 2

positive integer

View identifier 2, specified as an integer. View identifiers are unique to a specific view.

Output Arguments

vSet — View set with deleted connections

`imageviewset` object

View set with deleted connections, returned as an `imageviewset` object.

See Also

Objects

`imageviewset`

Introduced in R2020a

hasConnection

Check if connection between two views is in view set

Syntax

```
tf = hasConnection(vSet,viewId1,viewId2)
```

Description

`tf = hasConnection(vSet,viewId1,viewId2)` returns 1 (true), if the connection between views `viewId1` and `viewId2` is in the view set, `vSet`. The function returns 0 (false), if the connection does not exist in `vSet`.

Examples

Check For Connection Between Views in View Set

Create an empty image view set.

```
vSet = imageviewset;
```

Add two views to the image view set.

```
vSet = addView(vSet,1);
vSet = addView(vSet,2);
```

Add a connection to the image view set.

```
vSet = addConnection(vSet,1,2);
```

Check if the connection between views is in the view set.

```
tf = hasConnection(vSet,1,2)
```

```
tf = logical
    1
```

Input Arguments

vSet — Image view set

imageviewset object

Image view set, specified as an imageviewset object.

viewId1 — View identifier 1

positive integer

View identifier 1, specified as an integer. View identifiers are unique to a specific view.

viewId2 — View identifier 2

positive integer

View identifier 2, specified as an integer. View identifiers are unique to a specific view.

Output Arguments**tf — True or false result**

1 | 0

True or false result indicating if view is in view set vSet, returned as a 1 or 0 data type `logical`.

See Also**Objects**

imageviewset

Introduced in R2020a

connectedViews

Return connected views

Syntax

```
viewTable = connectedViews(vSet,viewId)
viewTable = connectedViews(vSet,viewId,minNumMatches)
```

Description

`viewTable = connectedViews(vSet,viewId)` returns a table of views from `vSet` that are connected to the view specified by `viewId`.

`viewTable = connectedViews(vSet,viewId,minNumMatches)` also specifies the minimum number of matched feature points in a connection for the view to be counted as a connected view.

Examples

Get Connected Views in View Set

Create an empty imageviewset object.

```
vSet = imageviewset;
```

Add views to the image view set.

```
vSet = addView(vSet, 1);
vSet = addView(vSet, 2);
vSet = addView(vSet, 3);
vSet = addView(vSet, 4);
```

Connect views in the image view set.

```
vSet = addConnection(vSet,1,2);
vSet = addConnection(vSet,2,3);
vSet = addConnection(vSet,2,4);
```

Get the connected views for the view with ID 2.

```
viewTable = connectedViews(vSet,2)
```

```
viewTable=3x4 table
```

ViewId	AbsolutePose	Features	Points
1	1x1 rigid3d	{0x0 double}	{0x0 double}
3	1x1 rigid3d	{0x0 double}	{0x0 double}
4	1x1 rigid3d	{0x0 double}	{0x0 double}

Input Arguments

vSet — Image view set

imageviewset object

Image view set, specified as an imageviewset object.

viewId — View identifier

positive integer

View identifier, specified as an integer. View identifiers are unique to a specific view.

minNumMatches — Minimum number of matched feature points

positive integer

Minimum number of matched feature points in a connection for the view to be counted as a connected view, specified as a positive integer.

Output Arguments

viewTable — One or more views

two-column table | three-column table

One or more views, returned as a three-column table. The table must contain the columns as described in this table.

Column	Description
ViewID	View identifier, specified as an integer. View identifiers are unique to a specific view.
AbsolutePose	Absolute pose of the view, specified as a rigid3d object.
Points	Point cloud for the view, specified as a pointCloud object.

See Also

Objects

imageviewset | rigid3d

Introduced in R2020a

poses

Absolute poses associated with views in view set

Syntax

```
sensorPoses = poses(vSet)
```

Description

`sensorPoses = poses(vSet)` returns a table of absolute poses associated with the views contained in the view set, `vSet`.

Examples

Retrieve Absolute Poses From Image View Set

Load images into the workspace.

```
imageDir = fullfile(toolboxdir('vision'),'visiondata','structureFromMotion');
images = imageDatastore(imageDir);
```

Compute features for the first image.

```
I = im2gray(readimage(images,1));
pointsPrev = detectSURFFeatures(I);
[featuresPrev,pointsPrev] = extractFeatures(I,pointsPrev);
```

Create an image view set and add the extracted feature points to the image view set.

```
vSet = imageviewset;
vSet = addView(vSet,1,'Points',pointsPrev);
```

Compute features and matches for the rest of the images.

```
for i = 2:numel(images.Files)
    I = im2gray(readimage(images,i));
    points = detectSURFFeatures(I);
    [features,points] = extractFeatures(I,points);
    vSet = addView(vSet,i,'Features',features,'Points',points);
    pairsIdx = matchFeatures(featuresPrev,features);
    vSet = addConnection(vSet,i-1,i,'Matches',pairsIdx);
    featuresPrev = features;
end
```

Get the absolute poses.

```
sensorPoses = poses(vSet)
```

```
sensorPoses=5×2 table
    ViewId    AbsolutePose
    _____    _____
```

```
1      1x1 rigid3d
2      1x1 rigid3d
3      1x1 rigid3d
4      1x1 rigid3d
5      1x1 rigid3d
```

Input Arguments

vSet — Image view set

imageviewset object

Image view set, specified as an `imageviewset` object.

Output Arguments

sensorPoses — Absolute poses

two-column table

Absolute poses, returned as a two-column table. The table contains columns as described in this table.

Column	Description
ViewID	View identifier, returned as a positive integer. View identifiers are unique to a specific view.
AbsolutePose	Absolute pose of the view, specified as a <code>rigid3d</code> object.

See Also

Objects

imageviewset | rigid3d

Introduced in R2020a

optimizePoses

Optimize absolute poses using relative pose constraints

Syntax

```
vSetOptim = optimizePoses(vSet)
[vSetOptim,poseScale] = optimizePoses(vSet)
vSetOptim = optimizePoses(vSet, minNumMatches)
vSetOptim = optimizePoses( ____,Name,Value)
```

Description

`vSetOptim = optimizePoses(vSet)` returns an image view set whose absolute poses are optimized. `vSetOptim` and `vSet` are `imageviewset` objects.

The `optimizePoses` function performs pose graph optimization on the absolute poses for the `Views` in the view set using the relative pose constraints established by the `Connections` property. You can use `optimizePoses` to correct drift in odometry after detecting loop closures.

`[vSetOptim,poseScale] = optimizePoses(vSet)` also returns the scales associated with the optimized absolute poses. This output applies only when the `RelativePose` of at least one connection is represented as an `affine3d` object.

`vSetOptim = optimizePoses(vSet, minNumMatches)` additionally specifies the minimum number of matched feature points in a connection in order for the connection to be included in optimization.

`vSetOptim = optimizePoses(____,Name,Value)` uses additional options specified by one or more `Name,Value` pair arguments.

Examples

Create and Optimize Poses Using Image View Set

Create a view set.

```
vSet = imageviewset;
```

Add four nodes and specify absolute poses.

```
absPoses = repelem(rigid3d, 4, 1);

absPoses(1).Translation = [ 0  0 0];
absPoses(2).Translation = [ 1  0 0];
absPoses(3).Translation = [ 2  0 0];
absPoses(4).Translation = [ 0.1 0 0];

vSet = addView(vSet, 1, absPoses(1));
vSet = addView(vSet, 2, absPoses(2));
```

```
vSet = addView(vSet, 3, absPoses(3));  
vSet = addView(vSet, 4, absPoses(4));
```

Define 4 edges, 3 odometry and 1 loop closure.

```
relPoses = repelem(rigid3d, 4, 1);
```

```
relPoses(1).Translation = [ 1  0 0];  
relPoses(2).Translation = [ 1  0 0];  
relPoses(3).Translation = [-1.9 0 0];  
relPoses(4).Translation = [ 0.2 0 0];
```

```
vSet = addConnection(vSet, 1, 2, relPoses(1)); % odometry  
vSet = addConnection(vSet, 2, 3, relPoses(2)); % odometry  
vSet = addConnection(vSet, 3, 4, relPoses(3)); % odometry  
vSet = addConnection(vSet, 4, 1, relPoses(4)); % loop closure
```

Optimize view set.

```
vSetOptim = optimizePoses(vSet);
```

Display original and optimized locations.

```
disp('Original absolute translations:')
```

```
Original absolute translations:
```

```
disp(vertcat(vSet.Views.AbsolutePose.Translation))
```

```
      0      0      0  
1.0000      0      0  
2.0000      0      0  
0.1000      0      0
```

```
disp('Optimized absolute translations:')
```

```
Optimized absolute translations:
```

```
disp(vertcat(vSetOptim.Views.AbsolutePose.Translation))
```

```
      0      0      0  
0.9250      0      0  
1.8500      0      0  
-0.1250      0      0
```

Input Arguments

vSet — Image view set

imageviewset object

Image view set, specified as an imageviewset object.

minNumMatches — Minimum number of connections

positive integer

Minimum number of connections, specified as a positive integer. Set `minNumMatches` to the minimum number of matched feature points in a connection for the connection to be included in optimization.

Name-Value Pair Arguments

Specify optional comma-separated pairs of `Name`, `Value` arguments. `Name` is the argument name and `Value` is the corresponding value. `Name` must appear inside quotes. You can specify several name and value pair arguments in any order as `Name1, Value1, . . . , NameN, ValueN`.

Example: `'MaxIterations',300`

MaxIterations — Maximum number of iterations

300 (default) | positive integer

Maximum number of iterations before optimization is terminated, specified as the comma-separated pair consisting of `'MaxIterations'` and a positive integer. Increase this value for more accurate results. Decrease this value for faster results.

Tolerance — Tolerance of the optimization cost function

1e-8 (default) | positive scalar

Tolerance of the optimization cost function between two iterations, specified as the comma-separated pair consisting of `'Tolerance'` and a positive scalar. Optimization is terminated when the cost function changes by less than the `Tolerance` value between two iterations.

Verbose — Display progress information

false (default) | true

Display progress information, specified as the comma-separated pair consisting of `Verbose` and a logical scalar. Set `'Verbose'` to `true` to display progress information.

Output Arguments

vSetOptim — Optimized absolute poses

imageviewset object

Image view set that contains optimized absolute poses, returned as an `imageviewset` object.

poseScale — Scales of optimized absolute poses

vector of positive values

Scales of optimized absolute poses, returned as a vector of positive values. This output applies only when the `RelativePose` of the pairwise “Connections” on page 2-0 property, of at least one connection is represented as an `affine3d` object.

Tips

- To update a view set with optimized poses, use the `updateView` object function.
- The `optimizePoses` object function holds the first view fixed.

Algorithms

The `optimizePoses` function uses the Levenberg Marquardt optimization algorithm with sparse Cholesky factorization from the general (hyper) graph optimization (g2o) library, (1 on page 2-212).

References

- [1] Kuemmerle, R., G. Grisetti, H. Strasdat, K. Konolige, and W. Burgard. "g2o: A General Framework for Graph Optimization IEEE International Conference on Robotics and Automation". *Proceedings of the IEEE International Conference on Robotics and Automation, ICRA, 2011.*

See Also

Functions

`createPoseGraph`

Objects

`imageviewset`

Introduced in R2020a

createPoseGraph

Create pose graph

Syntax

```
G = createPoseGraph(vSet)
```

Description

`G = createPoseGraph(vSet)` returns a pose graph derived from the views and connections in the view set, `vSet`.

You can use the pose graph for inspection, modification, visualization, and pose graph optimization.

Examples

Create Pose Graph from Image View Set

Create an empty image view set.

```
vSet = imageviewset;
```

Define three relative poses.

```
relPoses = repelem(rigid3d,3,1);
relPoses(1).Translation = [3 0 0];
relPoses(2).Translation = [5 0 0];
relPoses(3).Translation = [2 0 0]
```

```
relPoses =
  3x1 rigid3d array with properties:
```

```
    Dimensionality
    T
    Rotation
    Translation
```

Accumulate absolute poses.

```
absPoses = repelem(rigid3d,4,1);
absPoses(2).T = relPoses(1).T*absPoses(1).T;
absPoses(3).T = relPoses(2).T*absPoses(2).T;
absPoses(4).T = relPoses(3).T*absPoses(3).T;
```

Add four views to the image view set.

```
vSet = addView(vSet,1,absPoses(1));
vSet = addView(vSet,2,absPoses(2));
vSet = addView(vSet,3,absPoses(3));
vSet = addView(vSet,4,absPoses(4));
```

Add three connections to the image view set.

```
vSet = addConnection(vSet,1,2,relPoses(1));  
vSet = addConnection(vSet,2,3,relPoses(2));  
vSet = addConnection(vSet,3,4,relPoses(3));
```

Add a loop closure connection to the image view set.

```
relPoses(4).Translation = [9 0 0];  
vSet = addConnection(vSet,4,1,relPoses(4));
```

Create a pose graph.

```
G = createPoseGraph(vSet);
```

Input Arguments

vSet – View set

imageviewset object

View set, specified as an imageviewset object.

Output Arguments

G – Pose graph

digraph object

Pose graph, returned as a digraph object. The nodes in the object correspond to views, and the edges in the object correspond to connections.

The EndNodes of the Edges in the G digraph correspond to indices into the Views table, (not ViewIds).

Tips

- The EndNodes of the Edges in the G digraph correspond to indices into the Views table, (not ViewIds).
- Use “Directed and Undirected Graphs” to inspect, modify, or visualize the pose graph.
- Use the optimizePoseGraph function to optimize the pose graph. Use of this function requires the Navigation Toolbox.

See Also

Functions

digraph | optimizePoses | optimizePoseGraph

Objects

imageviewset

Introduced in R2020a

findView

Find views associated with view identifiers

Syntax

```
views = findView(vSet,viewIds)
```

Description

`views = findView(vSet,viewIds)` finds the views associated with the specified view `viewIds` and returns the view attributes.

Examples

Find View Corresponding to View ID

Create an empty image view set.

```
vSet = imageviewset;
```

Add two images.

```
imageDir = fullfile(toolboxdir('vision'),'visiondata', ...
    'structureFromMotion');
I1 = rgb2gray(imread(fullfile(imageDir,'image1.jpg')));
I2 = rgb2gray(imread(fullfile(imageDir,'image2.jpg')));
```

Detect interest points in the two images

```
points1 = detectSURFFeatures(I1);
points2 = detectSURFFeatures(I2);
```

Extract features descriptors from the detected points.

```
[features1,validPoints1] = extractFeatures(I1,points1);
[features2,validPoints2] = extractFeatures(I2,points2);
```

Add the points to the imageviewset object.

```
vSet = addView(vSet,1,'Features',features1,'Points',validPoints1);
vSet = addView(vSet,2,'Features',features2,'Points',validPoints2);
```

Find the view that corresponds to `viewID` equal to 1.

```
view = findView(vSet,1)
```

```
view=1x4 table
    ViewId  AbsolutePose  Features  Points
    _____  _____  _____  _____
         1      1x1 rigid3d  {574x64 single}  {574x1 SURFPoints}
```

Check the feature points that correspond to viewID equal to 1.

```
view.Points{:}
```

```
ans =  
  574x1 SURFPoints array with properties:  
  
      Scale: [574x1 single]  
 SignOfLaplacian: [574x1 int8]  
 Orientation: [574x1 single]  
 Location: [574x2 single]  
 Metric: [574x1 single]  
 Count: 574
```

Input Arguments

vSet — Image view set

imageviewset object

Image view set, specified as an `imageviewset` object.

viewIds — View identifier

M-element vector

View identifiers, specified as an *M*-element vector of integers. Each view identifier is unique to a specific view.

Output Arguments

views — View attributes

four-column table

View attributes, returned as a four-column table. The table contains the columns `ViewId`, `AbsolutePose`, `Features`, and `Points` attribute descriptions.

See Also

Objects

imageviewset

Introduced in R2021b

findConnection

Find connections associated with view identifiers

Syntax

```
conn = findConnection(vSet,viewIds1,viewIds2)
```

Description

`conn = findConnection(vSet,viewIds1,viewIds2)` finds the connections between the specified view identifiers `viewIds1` and `viewIds2` and returns the connection attributes `conn`.

Examples

Find Connection Between Two Image View Sets

Create an empty imageviewset object.

```
vSet = imageviewset;
```

Add three views to the view set.

```
viewId1 = 10;
viewId2 = 5;
viewId3 = 2;
vSet = addView(vSet,viewId1);
vSet = addView(vSet,viewId2);
vSet = addView(vSet,viewId3);
```

Add a connection between viewId1 and viewId2.

```
relPose1 = rigid3d(eye(3),[0 0 1]);
vSet = addConnection(vSet,viewId1,viewId2,relPose1);
```

Add a connection between viewId2 and viewId3.

```
relPose2 = rigid3d(eye(3),[0 0 2]);
vSet = addConnection(vSet,viewId2,viewId3,relPose2);
```

Find the connection between viewId1 and viewId2.

```
conn = findConnection(vSet,viewId1,viewId2)
```

```
conn=1x5 table
   ViewId1   ViewId2   RelativePose   InformationMatrix   Matches
   _____   _____   _____   _____   _____
          10          5   {1x1 rigid3d}   {6x6 double}   {0x2 uint32}
```

Check the relative pose between viewId1 and viewId2.

```
conn.RelativePose{:}  
ans =  
  rigid3d with properties:  
    Rotation: [3x3 double]  
    Translation: [0 0 1]
```

Input Arguments

vSet — Image view set

imageviewset object

Image view set, specified as an imageviewset object.

viewIds1 — Initial view identifiers

M-element vector

Initial view identifiers, specified as an *M*-element vector of integers. Each view identifier is unique to a specific view.

viewIds2 — Connected view identifiers

M-element vector

Connected view identifiers, specified as an *M*-element vector of integers. Each view identifier is unique to a specific view.

Output Arguments

conn — Connection attributes

five-column table

Connection attributes, returned as a five-column table. The table contains the columns ViewId1, ViewId2, RelativePose, InformationMatrix, and Matches.

See Also

Objects

imageviewset

Introduced in R2021b

findTracks

Find matched points across multiple views

Syntax

```
tracks = findTracks(vSet)
tracks = findTracks(vSet,viewIds)
tracks = findTracks( ___, 'MinTrackLength', trackLength)
```

Description

`tracks = findTracks(vSet)` finds and returns point tracks across multiple views in the view set, `vSet`. Each track contains 2-D projections of the same 3-D world point.

`tracks = findTracks(vSet,viewIds)` finds point tracks across a subset of views specified by `viewIds`.

`tracks = findTracks(___, 'MinTrackLength', trackLength)` specifies the minimum length of the tracks.

Examples

Find Point Tracks Across Sequence Of Images

Load images

```
imageDir = fullfile(toolboxdir('vision'),'visiondata','structureFromMotion');
images = imageDatastore(imageDir);
```

Compute features for the first image.

```
I = rgb2gray(readimage(images,1));
pointsPrev = detectSURFFeatures(I);
[featuresPrev, pointsPrev] = extractFeatures(I,pointsPrev);
```

Create an image view set object and add feature points of first image.

```
vSet = imageviewset;
vSet = addView(vSet,1,'Points',pointsPrev);
```

Compute features and matches for the rest of the images and add to the image view set.

```
for i = 2:numel(images.Files)
    I = rgb2gray(readimage(images,i));
    points = detectSURFFeatures(I);
    [features, points] = extractFeatures(I,points);
    vSet = addView(vSet, i, 'Features', features, 'Points', points);
    pairsIdx = matchFeatures(featuresPrev, features);
    vSet = addConnection(vSet, i-1, i, 'Matches', pairsIdx);
    featuresPrev = features;
end
```

Find point tracks across the sequence of images.

```
tracks = findTracks(vSet);
```

Input Arguments

vSet — Image view set

imageviewset object

Image view set, specified as an imageviewset object.

viewIds — View identifiers

vector of integers

View identifiers, specified as a vector of positive integers. View identifiers are unique to a specific view.

trackLength — Minimum length of the tracks

positive integer equal to or greater than 2

Minimum length of the tracks, specified as a positive integer equal to or greater than 2.

Output Arguments

tracks — Point tracks

pointTrack object

Point tracks across multiple views, returned as a pointTrack object.

See Also

Functions

detectSURFFeatures | detectMinEigenFeatures | detectHarrisFeatures |
detectMSERFeatures | detectFASTFeatures | detectBRISKFeatures | matchFeatures |
bundleAdjustment | triangulateMultiview

Objects

imageviewset | pointTrack

Introduced in R2020a

plot

Plot view set views and connections

Syntax

```
plot(vSet)
h = plot(vSet)
plot(vSet,Name,Value)
```

Description

`plot(vSet)` plots the views and connections in the view set, `vSet`.

`h = plot(vSet)` returns a graph plot, `h`

`plot(vSet,Name,Value)` specifies options using one or more name-value pair arguments.

Examples

Plot View Set View Identifiers

Create an empty image view set.

```
vSet = imageviewset;
```

Define three relative poses.

```
relPoses = repelem(rigid3d,3,1);
relPoses(1).Translation = [3 0 0];
relPoses(2).Translation = [5 0 0];
relPoses(3).Translation = [2 0 0];
```

Calculate and add absolute poses.

```
absPoses = repelem(rigid3d,4,1);
absPoses(2).T = relPoses(1).T*absPoses(1).T;
absPoses(3).T = relPoses(2).T*absPoses(2).T;
absPoses(4).T = relPoses(3).T*absPoses(3).T;
```

Add four views to the image view set.

```
vSet = addView(vSet,1,absPoses(1));
vSet = addView(vSet,2,absPoses(2));
vSet = addView(vSet,3,absPoses(3));
vSet = addView(vSet,4,absPoses(4));
```

Add connections between the added views.

```
vSet = addConnection(vSet,1,2,relPoses(1));
vSet = addConnection(vSet,2,3,relPoses(2));
vSet = addConnection(vSet,3,4,relPoses(3));
```

Plot the view set with view identifiers.

```
plot(vSet, 'ShowViewIds', 'on')
```

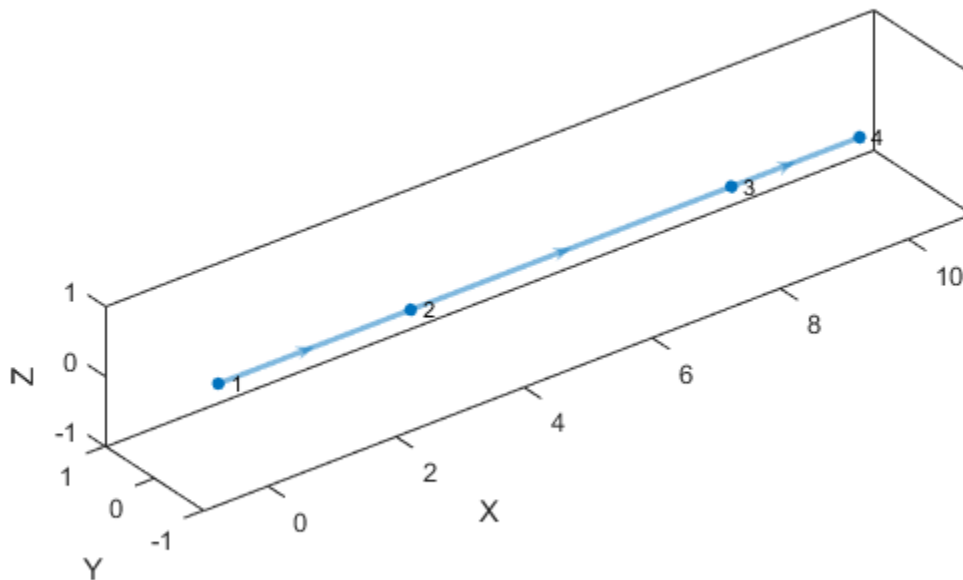

Input Arguments

vSet — Image view set

pcviewset object

Image view set, specified as a `imageviewset` object.

Name-Value Pair Arguments

Specify optional comma-separated pairs of `Name`, `Value` arguments. `Name` is the argument name and `Value` is the corresponding value. `Name` must appear inside quotes. You can specify several name and value pair arguments in any order as `Name1`, `Value1`, ..., `NameN`, `ValueN`.

Example: `'ShowViewIds', off`

Parent — Axes on which to plot view set

Axes object (default)

Axes on which to plot view set, specified as the comma-separated pair consisting of `'Parent'` and an Axes object. To create an Axes object, use the `axes` function.

ShowViewIds — Display of view identifiers`'off'` (default) | `'on'`

Display of view identifiers, specified as the comma-separated pair consisting of `'ShowViewIds'` and `'on'` or `'off'`.

Output Arguments**h — Graph plot**`GraphPlot` object

Graph plot, returned as a `GraphPlot` object. You can use the `GraphPlot` object functions and properties to inspect and adjust the plotted graph.

See Also**Functions**`axes` | `GraphPlot`**Objects**`imageviewset` | `pcviewset`**Introduced in R2020a**

ssdObjectDetector

Detect objects using SSD deep learning detector

Description

The `ssdObjectDetector` detects objects from an image, using a single shot detector (SSD) object detector. To detect objects in an image, pass the trained detector to the `detect` function.

Creation

Create an `ssdObjectDetector` detector object by calling the `trainSSDObjectDetector` function with training data (requires Deep Learning Toolbox).

```
detector = trainSSDObjectDetector(trainingData,...)
```

To detect objects in an image, pass the `detector` to the `detect` function.

Properties

ModelName — Name of classification model

character vector | string scalar

This property is read-only.

Name of the classification model, specified as a character vector or string scalar. By default, the name is set to the heading of the second column of the `trainingData` table specified in the `trainSSDObjectDetector` function. You can modify this name after creating your `ssdObjectDetector` object.

Network — Trained SSD multibox object detection network

DAGNetwork object

This property is read-only.

Trained SSD multibox object detection network, specified as a `DAGNetwork` object. This object stores the layers that define the convolutional neural network used within the SSD detector.

AnchorBoxes — Size of anchor boxes

P -by-1 cell array

This property is read-only.

Size of anchor boxes, specified as a P -by-1 cell array for P number of feature extraction layers used for object detection in the SSD network. Each element of the array contains an M -by-2 matrix of anchor box sizes, in the format `[height width]`. Each cell can contain a different number of anchor boxes. This value is set during training.

ClassNames — Object class names

cell array

This property is read-only.

Names of the object classes that the SSD detector was trained to find, specified as a cell array. This property is set by the `trainingData` input argument for the `trainSSDObjectDetector` function.

Object Functions

`detect` Detect objects using SSD multibox object detector

Examples

Detect Vehicles Using SSD Object Detector

Load a pretrained single shot detector (SSD) object to detect vehicles in an image. The detector is trained with images of cars on a highway scene.

```
vehicleDetector = load('ssdVehicleDetector.mat','detector');  
detector = vehicleDetector.detector;
```

Read a test image into the workspace.

```
I = imread('highway.png');
```

Display the test image.

```
imshow(I);
```



Run the pretrained SSD object detector by using the `detect` function. The output contains the bounding boxes, scores, and the labels for vehicles detected in the image. The labels are derived from the `ClassNames` property of the detector.

```
[bboxes,scores,labels] = detect(detector,I)
```

```
bboxes = 2x4
    139    78    96    81
     99    67   165   146

scores = 2x1 single column vector
    0.8349
    0.6302

labels = 2x1 categorical
    vehicle
    vehicle
```

Annotate the image with the detection results.

```
if ~isempty(bboxes)
    detectedI = insertObjectAnnotation(I,'rectangle',bboxes,cellstr(labels));
else
    detectedI = insertText(I,[10 10],'No Detections');
end

figure
imshow(detectedI)
```

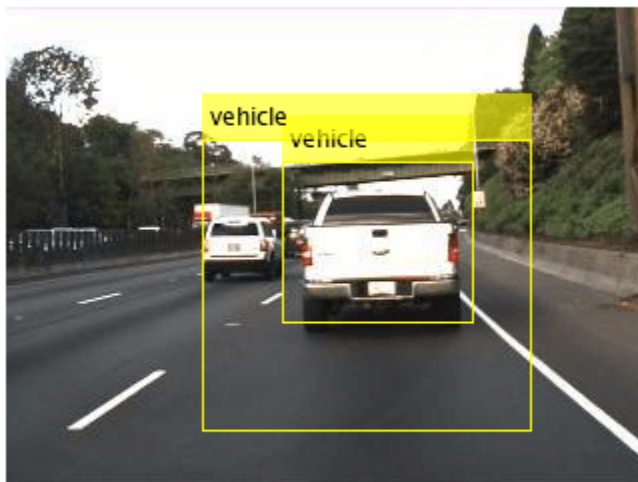

Extended Capabilities

C/C++ Code Generation

Generate C and C++ code using MATLAB® Coder™.

Usage notes and limitations:

- Only the `detect` method of the `ssdObjectDetector` is supported for code generation.
- The `roi` argument to the `detect` method must be a codegen constant (`coder.const()`) and a 1x4 vector.
- Only the `Threshold`, `SelectStrongest`, `MinSize`, `MaxSize`, and `MiniBatchSize` Name-Value pairs are supported. All Name-Value pairs must be compile-time constants.
- The channel and batch size of the input image must be fixed size.
- The `labels` output is returned as a categorical array.
- In the generated code, the input is rescaled to the size of the input layer of the network. But the bounding box that the `detect` method returns is in reference to the original input size.

GPU Code Generation

Generate CUDA® code for NVIDIA® GPUs using GPU Coder™.

Usage notes and limitations:

For code generation,

- Only the `detect` method of the `ssdObjectDetector` is supported for code generation.
- The `roi` argument to the `detect` method must be a codegen constant (`coder.const()`) and a 1x4 vector.
- Only the `Threshold`, `SelectStrongest`, `MinSize`, `MaxSize`, and `MiniBatchSize` Name-Value pairs are supported.
- The channel and batch size of the input image must be fixed size.
- The `labels` output is returned as a categorical array.

See Also

Apps

[Image Labeler](#) | [Video Labeler](#)

Objects

[DAGNetwork](#)

Functions

[ssdLayers](#) | [trainSSDObjectDetector](#) | [trainYOLOv2ObjectDetector](#) | [trainFasterRCNNObjectDetector](#) | [trainACFObjectDetector](#) | [trainNetwork](#) | [selectStrongestBboxMulticlass](#) | [anchorBoxLayer](#) | [focalLossLayer](#)

Topics

[“Object Detection Using SSD Deep Learning”](#)

[“Create SSD Object Detection Network”](#)

[“Estimate Anchor Boxes From Training Data”](#)

[“Code Generation for Object Detection by Using Single Shot Multibox Detector”](#)

[“Getting Started with SSD Multibox Detection”](#)

[“Datastores for Deep Learning” \(Deep Learning Toolbox\)](#)

Introduced in R2020a

detect

Detect objects using SSD multibox object detector

Syntax

```
bboxes = detect(detector,I)
[bboxes,scores] = detect(detector,I)
[ ____,labels] = detect(detector,I)
[ ____ ] = detect( ____,roi)

detectionResults = detect(detector,ds)

[ ____ ] = detect( ____,Name,Value)
```

Description

`bboxes = detect(detector,I)` detects objects within a single image or an array of images, `I`, using a single shot multibox detector (SSD). The locations of objects detected are returned as a set of bounding boxes.

When using this function, use of a CUDA enabled NVIDIA GPU is highly recommended. The GPU reduces computation time significantly. Usage of the GPU requires Parallel Computing Toolbox. For information about the supported compute capabilities, see “GPU Support by Release” (Parallel Computing Toolbox).

`[bboxes,scores] = detect(detector,I)` also returns the detection scores for each bounding box.

`[____,labels] = detect(detector,I)` also returns a categorical array of labels assigned to the bounding boxes, using either of the preceding syntaxes. The labels used for object classes are defined during training using the `trainSSDObjectDetector` function.

`[____] = detect(____,roi)` detects objects within the rectangular search region specified by `roi`.

`detectionResults = detect(detector,ds)` detects objects within the series of images returned by the `read` function of the input datastore.

`[____] = detect(____,Name,Value)` specifies options using one or more `Name,Value` pair arguments. For example, `detect(detector,I,'Threshold',0.75)` sets the detection score threshold to 0.75. Any detections with a lower score are removed.

Examples

Detect Vehicles Using SSD Object Detector

Load a pretrained single shot detector (SSD) object to detect vehicles in an image. The detector is trained with images of cars on a highway scene.

```
vehicleDetector = load('ssdVehicleDetector.mat','detector');  
detector = vehicleDetector.detector;
```

Read a test image into the workspace.

```
I = imread('highway.png');
```

Display the test image.

```
imshow(I);
```



Run the pretrained SSD object detector by using the `detect` function. The output contains the bounding boxes, scores, and the labels for vehicles detected in the image. The labels are derived from the `ClassNames` property of the detector.

```
[bboxes,scores,labels] = detect(detector,I)
```

```
bboxes = 2x4
```

```
    139    78    96    81  
     99    67   165   146
```

```
scores = 2x1 single column vector
```

```
    0.8349  
    0.6302
```

```
labels = 2x1 categorical
```

```
    vehicle  
    vehicle
```

Annotate the image with the detection results.

```

if ~isempty(bboxes)
    detectedI = insertObjectAnnotation(I, 'rectangle', bboxes, cellstr(labels));
else
    detectedI = insertText(I, [10 10], 'No Detections');
end

figure
imshow(detectedI)

```

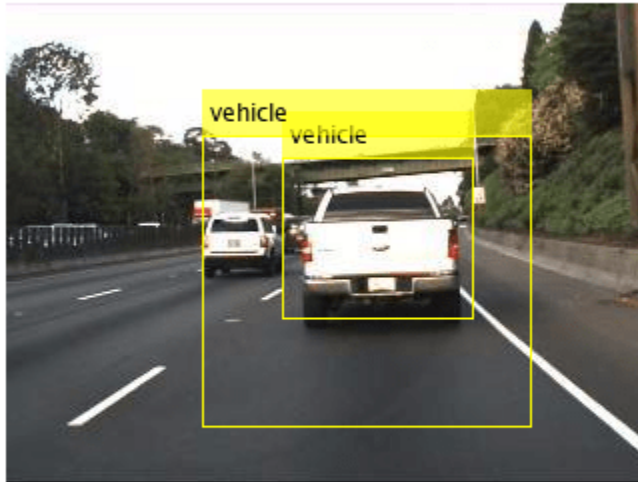

Input Arguments

detector — SSD object detector

ssdObjectDetector object

SSD object detector, specified as an `ssdObjectDetector` object. To create this object, call the `trainSSDObjectDetector` function with training data as input.

I — Input image

H-by-*W*-by-*C*-by-*B* numeric array of images

Input image, specified as an *H*-by-*W*-by-*C*-by-*B* numeric array of images. Images must be real, nonsparse, grayscale or RGB image.

- *H*: Height
- *W*: Width
- *C*: The channel size in each image must be equal to the network's input channel size. For example, for grayscale images, *C* must be equal to 1. For RGB color images, it must be equal to 3.
- *B*: The number of images in the array.

The detector is sensitive to the range of the input image. Therefore, ensure that the input image range is similar to the range of the images used to train the detector. For example, if the detector was

trained on `uint8` images, rescale this input image to the range `[0, 255]` by using the `im2uint8` or `rescale` function. The size of this input image should be comparable to the sizes of the images used in training. If these sizes are very different, the detector has difficulty detecting objects because the scale of the objects in the input image differs from the scale of the objects the detector was trained to identify. Consider whether you used the `SmallestImageDimension` property during training to modify the size of training images.

Data Types: `uint8` | `uint16` | `int16` | `double` | `single` | `logical`

ds — Datastore

`datastore` object

Datastore, specified as a datastore object containing a collection of images. Each image must be a grayscale, RGB, or multichannel image. The function processes only the first column of the datastore, which must contain images and must be cell arrays or tables with multiple columns.

roi — Search region of interest

`[x y width height]` vector

Search region of interest, specified as an `[x y width height]` vector. The vector specifies the upper left corner and size of a region in pixels.

Name-Value Pair Arguments

Specify optional comma-separated pairs of `Name`, `Value` arguments. `Name` is the argument name and `Value` is the corresponding value. `Name` must appear inside quotes. You can specify several name and value pair arguments in any order as `Name1, Value1, ..., NameN, ValueN`.

Example: `'SelectStrongest', true`

Threshold — Detection threshold

`0.5` (default) | scalar

Detection threshold, specified as a scalar in the range `[0, 1]`. Detections that have scores less than this threshold value are removed. To reduce false positives, increase this value.

SelectStrongest — Select strongest bounding box

`true` (default) | `false`

Select the strongest bounding box for each detected object, specified as the comma-separated pair consisting of `'SelectStrongest'` and either `true` or `false`.

- `true` — Return the strongest bounding box per object. To select these boxes, `detect` calls the `selectStrongestBboxMulticlass` function, which uses nonmaximal suppression to eliminate overlapping bounding boxes based on their confidence scores.

For example:

```
selectStrongestBboxMulticlass(bbox, scores, ...
    'RatioType', 'Union', ...
    'OverlapThreshold', 0.5);
```

- `false` — Return all detected bounding boxes. You can then create your own custom operation to eliminate overlapping bounding boxes.

MaxSize — Maximum region size

`size(I)` (default) | `[height width]` vector

Maximum region size that contains a detected object, specified as the comma-separated pair consisting of 'MaxSize' and a [*height width*] vector. Units are in pixels.

To reduce computation time, set this value to the known maximum region size for the objects being detected in the image. By default, 'MaxSize' is set to the height and width of the input image, I.

MinSize — Minimum region size

[1 1] (default) | [*height width*] vector

Minimum region size that contains a detected object, specified as the comma-separated pair consisting of 'MinSize', and [*height width*] vector. Units are in pixels.

To reduce computation time, set this value to the known minimum region size for the objects being detected in the image. By default, 'MinSize' is set to [1 1].

MiniBatchSize — Minimum batch size

128 (default) | scalar

Minimum batch size, specified as the comma-separated pair consisting of 'MiniBatchSize' and a scalar value. Use the MiniBatchSize to process a large collection of images. Images are grouped into minibatches and processed as a batch to improve computation efficiency. Increase the minibatch size to decrease processing time. Decrease the size to use less memory.

ExecutionEnvironment — Hardware resource

'auto' (default) | 'gpu' | 'cpu'

Hardware resource on which to run the detector, specified as the comma-separated pair consisting of 'ExecutionEnvironment' and 'auto', 'gpu', or 'cpu'.

- 'auto' — Use a GPU if it is available. Otherwise, use the CPU.
- 'gpu' — Use the GPU. To use a GPU, you must have Parallel Computing Toolbox and a CUDA enabled NVIDIA GPU. If a suitable GPU is not available, the function returns an error. For information about the supported compute capabilities, see “GPU Support by Release” (Parallel Computing Toolbox).
- 'cpu' — Use the CPU.

Output Arguments**bboxes — Location of objects detected**

M-by-4 matrix | *B*-by-1 cell array

Location of objects detected within the input image or images, returned as an *M*-by-4 matrix or a *B*-by-1 cell array. *M* is the number of bounding boxes in an image, and *B* is the number of *M*-by-4 matrices when the input contains an array of images.

Each row of **bboxes** contains a four-element vector of the form [*x y width height*]. This vector specifies the upper left corner and size of that corresponding bounding box in pixels.

scores — Detection scores

M-by-1 vector | *B*-by-1 cell array

Detection confidence scores, returned as an *M*-by-1 vector or a *B*-by-1 cell array. *M* is the number of bounding boxes in an image, and *B* is the number of *M*-by-1 vectors when the input contains an array of images. A higher score indicates higher confidence in the detection.

Labels — Labels for bounding boxes

M-by-1 categorical array | *B*-by-1 cell array

Labels for bounding boxes, returned as an *M*-by-1 categorical array or a *B*-by-1 cell array. *M* is the number of labels in an image, and *B* is the number of *M*-by-1 categorical arrays when the input contains an array of images. You define the class names used to label the objects when you train the input detector.

detectionResults — Detection results

3-column table

Detection results, returned as a 3-column table with variable names, *Boxes*, *Scores*, and *Labels*. The *Boxes* column contains *M*-by-4 matrices, of *M* bounding boxes for the objects found in the image. Each row contains a bounding box as a 4-element vector in the format [*x*,*y*,*width*,*height*]. The format specifies the upper-left corner location and size in pixels of the bounding box in the corresponding image.

See Also

Apps

[Image Labeler](#) | [Video Labeler](#)

Objects

[fasterRCNNObjectDetector](#) | [boxLabelDatastore](#)

Functions

[ssdLayers](#) | [trainSSDObjectDetector](#) | [trainYOLOv2ObjectDetector](#) | [trainFasterRCNNObjectDetector](#) | [selectStrongestBboxMulticlass](#) | [evaluateDetectionMissRate](#) | [evaluateDetectionPrecision](#) | [focalLossLayer](#) | [anchorBoxLayer](#) | [ssdMergeLayer](#)

Topics

[“Object Detection Using SSD Deep Learning”](#)
[“Create SSD Object Detection Network”](#)
[“Estimate Anchor Boxes From Training Data”](#)
[“Code Generation for Object Detection by Using Single Shot Multibox Detector”](#)
[“Getting Started with SSD Multibox Detection”](#)
[“Datastores for Deep Learning”](#) (Deep Learning Toolbox)

Introduced in R2020a

boxLabelDatastore

Datastore for bounding box label data

Description

The `boxLabelDatastore` object creates a datastore for bounding box label data. Use this object to read labeled bounding box data for object detection.

To read bounding box label data from a `boxLabelDatastore` object, use the `read` function. This object function returns a cell array with either two or three columns. You can create a datastore that combines the `boxLabelDatastore` object with an `ImageDatastore` object using the `combine` object function. Use the combined datastore to train object detectors using the training functions such as `trainYOLOv2ObjectDetector` and `trainFasterRCNNObjectDetector`. You can access and manage data in the datastore using object functions. To modify the `ReadSize` property, you can use dot notation.

Creation

Syntax

```
blds = boxLabelDatastore(tbl1,...,tbln)
blds = boxLabelDatastore(tbl1,...,tbln,bSet)
```

Description

`blds = boxLabelDatastore(tbl1,...,tbln)` creates a `boxLabelDatastore` object from one or more tables containing labeled bounding box data.

`blds = boxLabelDatastore(tbl1,...,tbln,bSet)` creates a `boxLabelDatastore` object from a `bigimage` data by using the resolution level, block size, and block positions specified by the block locations in `bSet`.

Input Arguments

tbl1, ..., tbln — Labeled bounding box data (as separate arguments)

table with one or more columns

Labeled bounding box data, specified as a table with one or more columns. Each table corresponds to a set of labels. The bounding boxes can be axis-aligned rectangles, rotated rectangles, or cuboids. The table below describes the format of the bounding boxes.

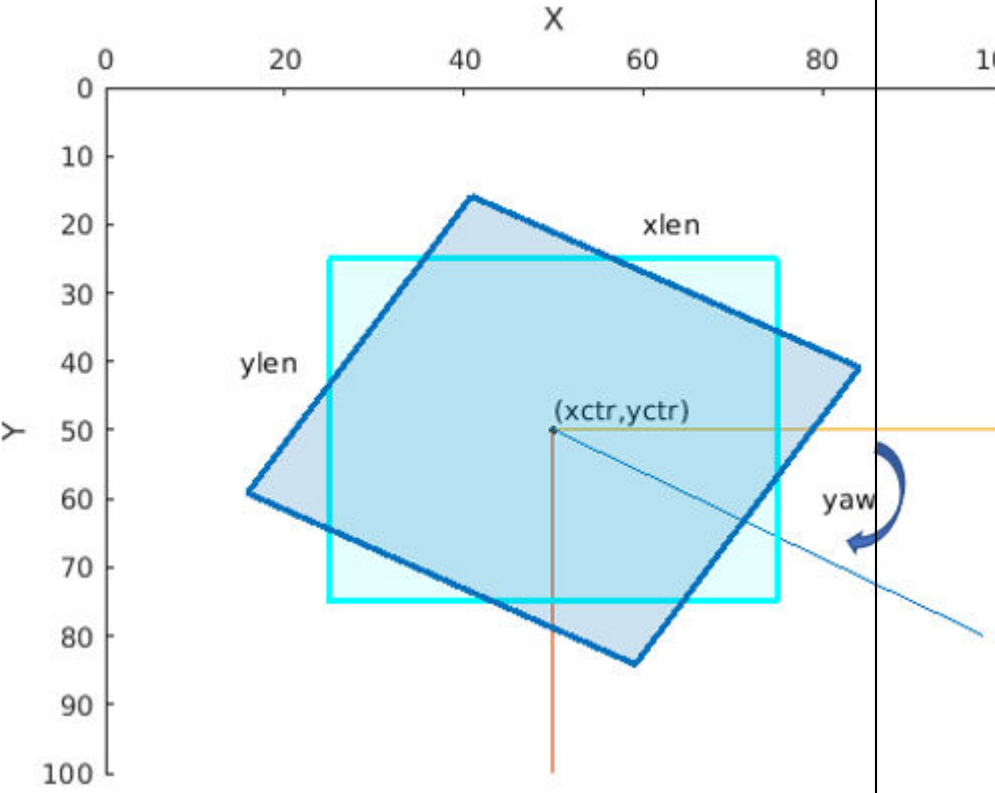
Bounding Box	Description
Axis-aligned rectangle	<p>Defined in pixel coordinates as an M-by-4 numeric matrix with rows of the form $[x\ y\ w\ h]$, where:</p> <ul style="list-style-type: none"> M is the number of axis-aligned rectangles. x and y specify the upper-left corner of the rectangle. w specifies the width of the rectangle, which is its length along the x-axis. h specifies the height of the rectangle, which is its length along the y-axis.
Rotated rectangle	<p>Defined in spatial coordinates as an M-by-5 numeric matrix with rows of the form $[xctr\ yctr\ xlen\ ylen\ yaw]$, where:</p> <ul style="list-style-type: none"> M is the number of rotated rectangles. $xctr$ and $yctr$ specify the center of the rectangle. $xlen$ specifies the width of the rectangle, which is its length along the x-axis before rotation. $ylen$ specifies the height of the rectangle, which is its length along the y-axis before rotation. yaw specifies the rotation angle in degrees. The rotation is clockwise-positive around the center of the bounding box. 

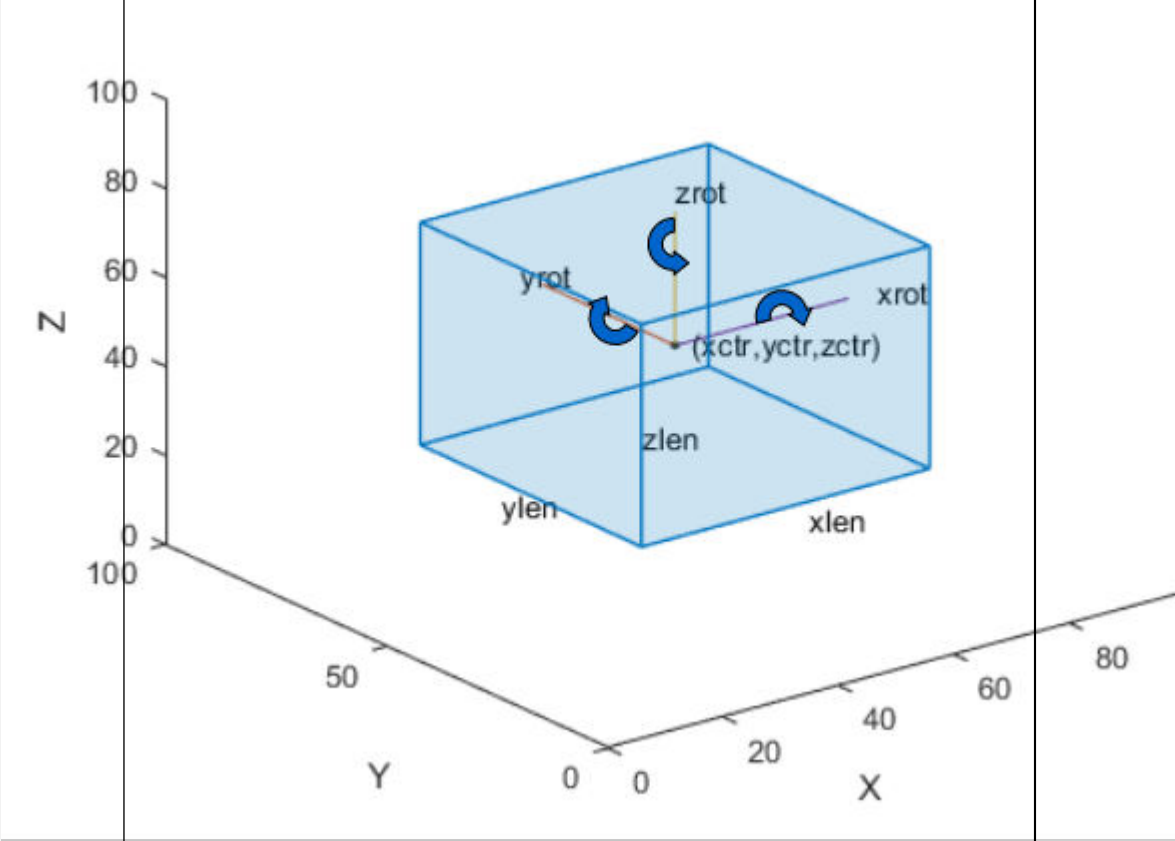
Bounding Box	Description
Cuboid	<p>Defined in spatial coordinates as an M-by-9 numeric matrix with rows of the form $[xctr\ yctr\ zctr\ xlen\ ylen\ zlen\ xrot\ yrot\ zrot]$, where:</p> <ul style="list-style-type: none"> • M is the number of cuboids. • $xctr$, $yctr$, and $zctr$ specify the center of the cuboid. • $xlen$, $ylen$, and $zlen$ specify the length of the cuboid along the x-axis, y-axis, and z-axis, respectively, before rotation. • $xrot$, $yrot$, and $zrot$ specify the rotation angles of the cuboid around the x-axis, y-axis, and z-axis, respectively. The $xrot$, $yrot$, and $zrot$ rotation angles are in degrees about the cuboid center. Each rotation is clockwise-positive with respect to the positive direction of the associated spatial axis. The function computes rotation matrices assuming ZYX order Euler angles $[xrot\ yrot\ zrot]$. <p>The figure shows how these values determine the position of a cuboid.</p> 

- A table with one or more columns:

All columns contain bounding boxes. Each column must be a cell vector containing M -by- N matrices. M is the number of images and N represents a single object class, such as *stopSign*, *carRear*, or *carFront*.

	1 stopSign	2 carRear	3 carFront
1	6x4 double	4x4 double	7x4 double
2	10x4 double	[561,304,763,194]	8x4 double
3	7x4 double	[733,913,716,32;926,343,203,762]	[513,492,927,625]
4	[428,1007,309,718]	7x4 double	6x4 double
5	3x4 double	4x4 double	5x4 double
6	9x4 double	6x4 double	[11,59,55,253;922,856,601,892]
7	5x4 double	4x4 double	5x4 double

- A table with two columns.

The first column contains bounding boxes. The second column must be a cell vector that contains the label names corresponding to each bounding box. Each element in the cell vector must be an M -by-1 categorical or string vector, where M represents the number of labels.

	1 Boxes	2 Labels
1	30x4 double	30x1 string
2	24x4 double	24x1 string
3	23x4 double	23x1 string
4	28x4 double	28x1 string
5	20x4 double	20x1 string
6	25x4 double	25x1 string
7	5x4 double	5x1 string

To create a ground truth table, use the **Image Labeler** or **Video Labeler** app. To create a table of training data from the generated ground truth, use the `objectDetectorTrainingData` function.

Data Types: table

bSet — Block locations

blockLocationSet object

Block locations, specified as a blockLocationSet object. You can create this object by using the `balanceBoxLabels` function.

Properties

LabelData — Labeled bounding box data

N -by-2 cell array

This property is read-only.

Labeled bounding box data, specified as an N -by-2 cell matrix of N images. The first column must be a cell vector that contains bounding boxes. Each element in the cell contains a vector representing either an axis-aligned rectangle, rotated rectangle, or a cuboid. The second column must be a cell vector that contains the label names corresponding to each bounding box. An M -by-1 categorical vector represents each label name.

Bounding Box Descriptions

Bounding Box	Cell Vector	Format
Axis-aligned rectangle	M -by-4 for M bounding boxes	$[x,y,width,height]$
Rotated rectangle	M -by-5 for M bounding boxes	$[xcenter,ycenter,width,height,yaw]$
Cuboid	M -by-9 for M bounding boxes	$[xcenter,ycenter,zcenter,width,height,depth,rx,ry,rz]$

ReadSize — Maximum number of rows of label data

1 (default) | positive integer

Maximum number of rows of label data to read in each call to the read function, specified as a positive integer.

Object Functions

combine	Combine data from multiple datastores
countEachLabel	Count occurrence of pixel or box labels
hasdata	Determine if data is available to read from datastore
numpartitions	Number of partitions for a datastore
partition	Partition a label datastore
preview	Read first row of data in datastore
progress	Percentage of data read from a datastore
read	Read data from a datastore
readall	Read all data in datastore
reset	Reset datastore to initial state
shuffle	Return shuffled version of datastore
subset	Create subset of datastore or file-set
transform	Transform datastore
isPartitionable	Determine whether datastore is partitionable
isShuffleable	Determine whether datastore is shuffleable

Examples

Estimate Anchor Boxes for YOLO v2 Object Detection Network

This example shows how to estimate anchor boxes using a table containing the training data. The first column contains the training images and the remaining columns contain the labeled bounding boxes.

```
data = load('vehicleTrainingData.mat');
trainingData = data.vehicleTrainingData;
```

Create a boxLabelDatastore object using the labeled bounding boxes from the training data.

```
blds = boxLabelDatastore(trainingData(:,2:end));
```

Estimate the anchor boxes using the boxLabelDatastore object.

```
numAnchors = 5;
anchorBoxes = estimateAnchorBoxes(blds,numAnchors);
```

Specify the image size.

```
inputImageSize = [128,228,3];
```

Specify the number of classes to detect.

```
numClasses = 1;
```

Use a pretrained ResNet-50 network as a base network for the YOLO v2 network.

```
network = resnet50();
```

Specify the network layer to use for feature extraction. You can use the `analyzeNetwork` function to see all the layer names in a network.

```
featureLayer = 'activation_49_relu';
```

Create the YOLO v2 object detection network.

```
lgraph = yolov2Layers(inputImageSize,numClasses,anchorBoxes,network, featureLayer)
```

```
lgraph =
```

```
  LayerGraph with properties:
```

```
    Layers: [182x1 nnet.cnn.layer.Layer]
 Connections: [197x2 table]
  InputNames: {'input_1'}
 OutputNames: {'yolov2OutputLayer'}
```

Visualize the network using the network analyzer.

```
analyzeNetwork(lgraph)
```

Combine Box Label Datastore and Image Label Datastore

Load a table of vehicle class training data that contains bounding boxes with labels.

```
data = load('vehicleTrainingData.mat');
trainingData = data.vehicleTrainingData;
```

Add the fullpath to the local vehicle data folder.

```
dataDir = fullfile(toolboxdir('vision'),'visiondata');
trainingData.imageFilename = fullfile(dataDir,trainingData.imageFilename);
```

Create an `imageDatastore` object using the file names in the table.

```
imds = imageDatastore(trainingData.imageFilename);
```

Create a `boxLabelDatastore` object using the table with label data.

```
blds = boxLabelDatastore(trainingData(:,2:end));
```

Combine the `imageDatastore` and `boxLabelDatastore` objects.

```
cds = combine(imds,blds);
```

Read the data for training. Use the `read` object function to return images, bounding boxes, and labels.

```
read(cds)

ans=1x3 cell array
    {128x228x3 uint8}    {[126 78 20 16]}    {[vehicle]}
```

Combine Multiple Class Ground Truth Data

Load a table of vehicle class training data that contains bounding boxes with labels.

```
load('vehicleTrainingData.mat');
```

Load a table of stop signs and cars class training data that contains bounding boxes with labels.

```
load('stopSignsAndCars.mat');
```

Create ground truth tables from the training data.

```
vehiclesTbl = vehicleTrainingData(:,2:end);
stopSignsTbl = stopSignsAndCars(:,2:end);
```

Create a `boxLabelDatastore` object using two tables: one with vehicle label data and the other with the stop signs and cars label data.

```
blds = boxLabelDatastore(vehiclesTbl,stopSignsTbl);
```

Create an `imageDatastore` object using the file names in the training data tables.

```
dataDir = fullfile(toolboxdir('vision'),'visiondata');
vehicleFiles = fullfile(dataDir,vehicleTrainingData.imageFilename);
stopSignFiles = fullfile(dataDir,stopSignsAndCars.imageFilename);
imds = imageDatastore([vehicleFiles;stopSignFiles]);
```

Combine the `imageDatastore` and `boxLabelDatastore` objects.

```
cds = combine(imds,blds);
```

Read the data for training. Use the `read` object function to return images, bounding boxes, and labels.

```
read(cds)

ans=1x3 cell array
    {128x228x3 uint8}    {[126 78 20 16]}    {[vehicle]}
```

See Also

Apps

Image Labeler | Video Labeler

Functions

estimateAnchorBoxes | analyzeNetwork | yolov2Layers | balanceBoxLabels

Objects

imageDatastore | blockLocationSet | bigimage

Topics

“Datastores for Deep Learning” (Deep Learning Toolbox)

“Deep Learning in MATLAB” (Deep Learning Toolbox)

“Training Data for Object Detection and Semantic Segmentation”

Introduced in R2019b

pixelLabelImageDatastore

Datastore for semantic segmentation networks

Description

Use `pixelLabelImageDatastore` to create a datastore for training a semantic segmentation network using deep learning.

Creation

Syntax

```
pximds = pixelLabelImageDatastore(gTruth)
pximds = pixelLabelImageDatastore(imds,pxds)
pximds = pixelLabelImageDatastore( ___,Name,Value)
```

Description

`pximds = pixelLabelImageDatastore(gTruth)` returns a datastore for training a semantic segmentation network based on the input `groundTruth` object or array of `groundTruth` objects. Use the output `pixelLabelImageDatastore` object with the Deep Learning Toolbox function `trainNetwork` to train convolutional neural networks for semantic segmentation.

`pximds = pixelLabelImageDatastore(imds,pxds)` returns a datastore based on the input image datastore and the pixel label datastore objects. `imds` is an `ImageDatastore` object that represents the training input to the network. `pxds` is a `PixelLabelDatastore` object that represents the required network output.

`pximds = pixelLabelImageDatastore(___,Name,Value)` additionally uses name-value pairs to set the `DispatchInBackground` and `OutputSizeMode` properties. For 2-D data, you can also use name-value pairs to specify the `ColorPreprocessing`, `DataAugmentation`, and `OutputSize` augmentation properties. You can specify multiple name-value pairs. Enclose each property name in quotes.

For example, `pixelLabelImageDatastore(gTruth, 'PatchesPerImage',40)` creates a pixel label image datastore that randomly generates 40 patches from each ground truth object in `gTruth`.

Input Arguments

gTruth — Ground truth data

`groundTruth` object | array of `groundTruth` objects

Ground truth data, specified as a `groundTruth` object or as an array of `groundTruth` objects. Each `groundTruth` object contains information about the data source, the list of label definitions, and all marked labels for a set of ground truth labels.

imds — Collection of images

`ImageDatastore` object

Collection of images, specified as an `ImageDatastore` object.

pxds — Collection of pixel labeled images

`PixelLabelDatastore` object

Collection of pixel labeled images, specified as a `PixelLabelDatastore` object. The object contains the pixel labeled images for each image contained in the `imds` input object.

Properties

Images — Image file names

character vector | cell array of character vectors

This property is read-only.

Image file names used as the source for ground truth images, specified as a character vector or a cell array of character vectors.

PixelLabelData — Pixel label file names

character | cell array of characters

This property is read-only.

Pixel label data file names used as the source for ground truth label images, specified as a character or a cell array of characters.

ClassNames — Class names

cell array of character vectors

This property is read-only.

Class names, specified as a cell array of character vectors.

ColorPreprocessing — Color channel preprocessing

'none' (default) | 'gray2rgb' | 'rgb2gray'

Color channel preprocessing for 2-D data, specified as 'none', 'gray2rgb', or 'rgb2gray'. Use this property when you need the image data created by the data source must be only color or grayscale, but the training set includes both. Suppose you need to train a network that expects color images but some of your training images are grayscale. Set `ColorPreprocessing` to 'gray2rgb' to replicate the color channels of the grayscale images in the input image set. Using the 'gray2rgb' option creates M -by- N -by-3 output images.

The `ColorPreprocessing` property is not supported for 3-D data. To perform color channel preprocessing of 3-D data, use the `transform` function.

DataAugmentation — Preprocessing applied to input images

'none' (default) | `imageDataAugmenter` object

Preprocessing applied to input images, specified as an `imageDataAugmenter` object or 'none'. When `DataAugmentation` is 'none', no preprocessing is applied to input images. Training data can be augmented in real-time during training.

The `DataAugmentation` property is not supported for 3-D data. To preprocess 3-D data, use the `transform` function.

DispatchInBackground — Dispatch observations in background`false` (default) | `true`

Dispatch observations in the background during training, prediction, and classification, specified as `false` or `true`. To use background dispatching, you must have Parallel Computing Toolbox. If `DispatchInBackground` is `true` and you have Parallel Computing Toolbox, then `pixelLabelImageDatastore` asynchronously reads patches, adds noise, and queues patch pairs.

MiniBatchSize — Number of observations in each batch

positive integer

Number of observations that are returned in each batch. The default value is equal to the `ReadSize` of image datastore `imds`. You can change the value of `MiniBatchSize` only after you create the datastore. For training, prediction, or classification, the `MiniBatchSize` property is set to the mini-batch size defined in `trainingOptions`.

NumObservations — Total number of observations in the datastore

positive integer

This property is read-only.

Total number of observations in the denoising image datastore. The number of observations is the length of one training epoch.

OutputSize — Size of output images`[]` (default) | vector of two positive integers

This property is read-only.

Size of output images, specified as a vector of two positive integers. The first element specifies the number of rows in the output images, and the second element specifies the number of columns. When you specify `OutputSize`, image sizes are adjusted as necessary. By default, this property is empty, which means that the images are not adjusted.

The `OutputSize` property is not supported for 3-D data. To set the output size of 3-D data, use the `transform` function.

OutputSizeMode — Method used to resize output images`'resize'` (default) | `'centercrop'` | `'randcrop'`

Method used to resize output images, specified as one of the following. This property applies only when you set `OutputSize` to a value other than `[]`.

- `'resize'` — Scale the image to fit the output size. For more information, see `imresize`.
- `'centercrop'` — Take a crop from the center of the training image. The crop has the same size as the output size.
- `'randcrop'` — Take a random crop from the training image. The random crop has the same size as the output size.

Data Types: `char` | `string`

Object Functions

`combine` Combine data from multiple datastores

countEachLabel	Count occurrence of pixel or box labels
hasdata	Determine if data is available to read
partitionByIndex	Partition pixelLabelImageDatastore according to indices
preview	Preview subset of data in datastore
read	Read data from a datastore
readall	Read all data in datastore
readByIndex	Read data specified by index from pixelLabelImageDatastore
reset	Reset datastore to initial state
shuffle	Return shuffled version of datastore
transform	Transform datastore

Examples

Train A Semantic Segmentation Network

Load the training data.

```
dataSetDir = fullfile(toolboxdir('vision'),'visiondata','triangleImages');
imageDir = fullfile(dataSetDir,'trainingImages');
labelDir = fullfile(dataSetDir,'trainingLabels');
```

Create an image datastore for the images.

```
imds = imageDatastore(imageDir);
```

Create a pixelLabelDatastore for the ground truth pixel labels.

```
classNames = ["triangle","background"];
labelIDs = [255 0];
pxds = pixelLabelDatastore(labelDir,classNames,labelIDs);
```

Visualize training images and ground truth pixel labels.

```
I = read(imds);
C = read(pxds);

I = imresize(I,5);
L = imresize(uint8(C{1}),5);
imshowpair(I,L,'montage')
```



Create a semantic segmentation network. This network uses a simple semantic segmentation network based on a downsampling and upsampling design.

```
numFilters = 64;
filterSize = 3;
numClasses = 2;
layers = [
    imageInputLayer([32 32 1])
    convolution2dLayer(filterSize,numFilters,'Padding',1)
    reluLayer()
    maxPooling2dLayer(2,'Stride',2)
    convolution2dLayer(filterSize,numFilters,'Padding',1)
    reluLayer()
    transposedConv2dLayer(4,numFilters,'Stride',2,'Cropping',1);
    convolution2dLayer(1,numClasses);
    softmaxLayer()
    pixelClassificationLayer()
];
```

Setup training options.

```
opts = trainingOptions('sgdm', ...
    'InitialLearnRate',1e-3, ...
    'MaxEpochs',100, ...
    'MiniBatchSize',64);
```

Combine the image and pixel label datastore for training.

```
trainingData = combine(imds,pxds);
```

Train the network.

```
net = trainNetwork(trainingData, layers, opts);
```

Training on single CPU.

Initializing input data normalization.

Epoch	Iteration	Time Elapsed (hh:mm:ss)	Mini-batch Accuracy	Mini-batch Loss	Base Learning Rate

1	1	00:00:00	58.11%	1.3458	0.0010
17	50	00:00:12	97.30%	0.0924	0.0010
34	100	00:00:24	98.09%	0.0575	0.0010
50	150	00:00:37	98.56%	0.0424	0.0010
67	200	00:00:49	98.48%	0.0435	0.0010
84	250	00:01:02	98.66%	0.0363	0.0010
100	300	00:01:14	98.90%	0.0310	0.0010

Training finished: Reached final iteration.

Read and display a test image.

```
testImage = imread('triangleTest.jpg');  
imshow(testImage)
```

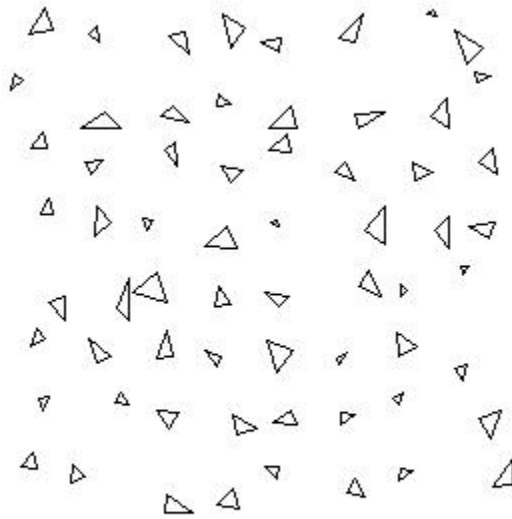

Segment the test image and display the results.

```
C = semanticseg(testImage,net);  
B = labeloverlay(testImage,C);  
imshow(B)
```

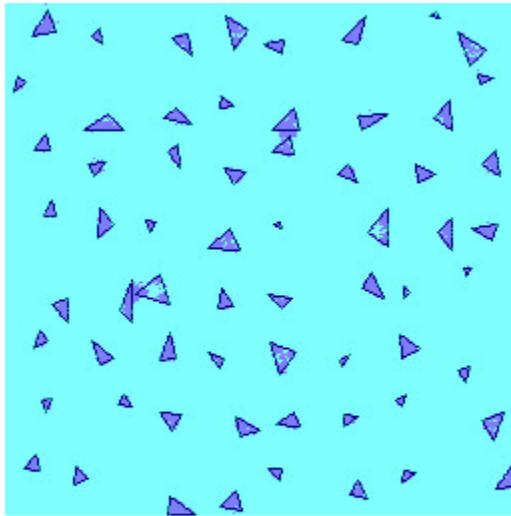

Augment Data While Training

Configure a pixel label image datastore to augment data while training.

Load training images and pixel labels.

```
dataSetDir = fullfile(toolboxdir('vision'),'visiondata','triangleImages');  
imageDir = fullfile(dataSetDir,'trainingImages');  
labelDir = fullfile(dataSetDir,'trainingLabels');
```

Create an `imageDatastore` object to hold the training images.

```
imds = imageDatastore(imageDir);
```

Define the class names and their associated label IDs.

```
classNames = ["triangle","background"];  
labelIDs = [255 0];
```

Create a `pixelLabelDatastore` object to hold the ground truth pixel labels for the training images.

```
pxds = pixelLabelDatastore(labelDir, classNames, labelIDs);
```

Create an `imageDataAugmenter` object to randomly rotate and mirror image data.

```
augmenter = imageDataAugmenter('RandRotation',[-10 10],'RandXReflection',true)  
augmenter =  
    imageDataAugmenter with properties:
```

```

        FillValue: 0
    RandXReflection: 1
    RandYReflection: 0
        RandRotation: [-10 10]
            RandScale: [1 1]
            RandXScale: [1 1]
            RandYScale: [1 1]
            RandXShear: [0 0]
            RandYShear: [0 0]
    RandXTranslation: [0 0]
    RandYTranslation: [0 0]

```

Create a `pixelLabelImageDatastore` object to train the network with augmented data.

```
plimds = pixelLabelImageDatastore(imds,pxds,'DataAugmentation',augmenter)
```

```
plimds =
    pixelLabelImageDatastore with properties:
```

```

        Images: {200x1 cell}
    PixelLabelData: {200x1 cell}
        ClassNames: {2x1 cell}
    DataAugmentation: [1x1 imageDataAugmenter]
    ColorPreprocessing: 'none'
        OutputSize: []
    OutputSizeMode: 'resize'
        MiniBatchSize: 1
    NumObservations: 200
    DispatchInBackground: 0

```

Semantic Segmentation Using Dilated Convolutions

Train a semantic segmentation network using dilated convolutions.

A semantic segmentation network classifies every pixel in an image, resulting in an image that is segmented by class. Applications for semantic segmentation include road segmentation for autonomous driving and cancer cell segmentation for medical diagnosis. To learn more, see “Getting Started with Semantic Segmentation Using Deep Learning”.

Semantic segmentation networks like DeepLab [1] make extensive use of dilated convolutions (also known as atrous convolutions) because they can increase the receptive field of the layer (the area of the input which the layers can see) without increasing the number of parameters or computations.

Load Training Data

The example uses a simple dataset of 32-by-32 triangle images for illustration purposes. The dataset includes accompanying pixel label ground truth data. Load the training data using an `imageDatastore` and a `pixelLabelDatastore`.

```

dataFolder = fullfile(toolboxdir('vision'),'visiondata','triangleImages');
imageFolderTrain = fullfile(dataFolder,'trainingImages');
labelFolderTrain = fullfile(dataFolder,'trainingLabels');

```

Create an `imageDatastore` for the images.

```
imdsTrain = imageDatastore(imageFolderTrain);
```

Create a `pixelLabelDatastore` for the ground truth pixel labels.

```
classNames = ["triangle" "background"];
labels = [255 0];
pxdsTrain = pixelLabelDatastore(labelFolderTrain,classNames,labels)
```

```
pxdsTrain =
  PixelLabelDatastore with properties:
        Files: {200x1 cell}
   ClassNames: {2x1 cell}
      ReadSize: 1
      ReadFcn: @readDatastoreImage
AlternateFileSystemRoots: {}
```

Create Semantic Segmentation Network

This example uses a simple semantic segmentation network based on dilated convolutions.

Create a data source for training data and get the pixel counts for each label.

```
ds = combine(imdsTrain,pxdsTrain);
tbl = countEachLabel(pxdsTrain)
```

```
tbl=2x3 table
      Name          PixelCount  ImagePixelCount
-----
{'triangle' }      10326        2.048e+05
{'background'}  1.9447e+05   2.048e+05
```

The majority of pixel labels are for background. This class imbalance biases the learning process in favor of the dominant class. To fix this, use class weighting to balance the classes. You can use several methods to compute class weights. One common method is inverse frequency weighting where the class weights are the inverse of the class frequencies. This method increases the weight given to under represented classes. Calculate the class weights using inverse frequency weighting.

```
numberPixels = sum(tbl.PixelCount);
frequency = tbl.PixelCount / numberPixels;
classWeights = 1 ./ frequency;
```

Create a network for pixel classification by using an image input layer with an input size corresponding to the size of the input images. Next, specify three blocks of convolution, batch normalization, and ReLU layers. For each convolutional layer, specify 32 3-by-3 filters with increasing dilation factors and pad the inputs so they are the same size as the outputs by setting the 'Padding' option to 'same'. To classify the pixels, include a convolutional layer with K 1-by-1 convolutions, where K is the number of classes, followed by a softmax layer and a `pixelClassificationLayer` with the inverse class weights.

```
inputSize = [32 32 1];
filterSize = 3;
numFilters = 32;
```

```

numClasses = numel(classNames);

layers = [
    imageInputLayer(inputSize)

    convolution2dLayer(filterSize,numFilters,'DilationFactor',1,'Padding','same')
    batchNormalizationLayer
    reluLayer

    convolution2dLayer(filterSize,numFilters,'DilationFactor',2,'Padding','same')
    batchNormalizationLayer
    reluLayer

    convolution2dLayer(filterSize,numFilters,'DilationFactor',4,'Padding','same')
    batchNormalizationLayer
    reluLayer

    convolution2dLayer(1,numClasses)
    softmaxLayer
    pixelClassificationLayer('Classes',classNames,'ClassWeights',classWeights)];

```

Train Network

Specify the training options.

```

options = trainingOptions('sgdm', ...
    'MaxEpochs', 100, ...
    'MiniBatchSize', 64, ...
    'InitialLearnRate', 1e-3);

```

Train the network using `trainNetwork`.

```
net = trainNetwork(ds, layers, options);
```

Training on single CPU.

Initializing input data normalization.

Epoch	Iteration	Time Elapsed (hh:mm:ss)	Mini-batch Accuracy	Mini-batch Loss	Base Learning Rate
1	1	00:00:01	91.62%	1.6825	0.0010
17	50	00:00:25	88.56%	0.2393	0.0010
34	100	00:00:49	92.08%	0.1672	0.0010
50	150	00:01:14	93.17%	0.1472	0.0010
67	200	00:01:42	94.15%	0.1313	0.0010
84	250	00:02:14	94.47%	0.1167	0.0010
100	300	00:02:38	95.04%	0.1100	0.0010

Training finished: Max epochs completed.

Test Network

Load the test data. Create an `imageDatastore` for the images. Create a `pixelLabelDatastore` for the ground truth pixel labels.

```

imageFolderTest = fullfile(dataFolder,'testImages');
imdsTest = imageDatastore(imageFolderTest);
labelFolderTest = fullfile(dataFolder,'testLabels');
pxdsTest = pixelLabelDatastore(labelFolderTest,classNames,labels);

```

Make predictions using the test data and trained network.

```
pxdsPred = semanticseg(imdsTest,net,'MiniBatchSize',32,'WriteLocation',tempdir);
```

```
Running semantic segmentation network
```

```
-----
```

```
* Processed 100 images.
```

Evaluate the prediction accuracy using `evaluateSemanticSegmentation`.

```
metrics = evaluateSemanticSegmentation(pxdsPred,pxdsTest);
```

```
Evaluating semantic segmentation results
```

```
-----
```

```
* Selected metrics: global accuracy, class accuracy, IoU, weighted IoU, BF score.
```

```
* Processed 100 images.
```

```
* Finalizing... Done.
```

```
* Data set metrics:
```

<u>GlobalAccuracy</u>	<u>MeanAccuracy</u>	<u>MeanIoU</u>	<u>WeightedIoU</u>	<u>MeanBFScore</u>
0.95237	0.97352	0.72081	0.92889	0.46416

For more information on evaluating semantic segmentation networks, see `evaluateSemanticSegmentation`.

Segment New Image

Read and display the test image `triangleTest.jpg`.

```
imgTest = imread('triangleTest.jpg');  
figure  
imshow(imgTest)
```

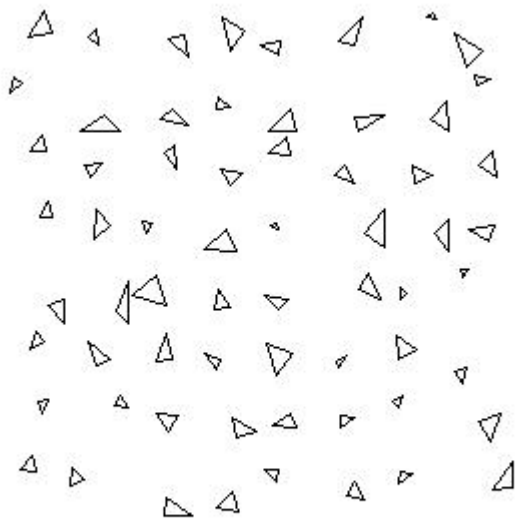

Segment the test image using `semanticseg` and display the results using `labeloverlay`.

```
C = semanticseg(imgTest,net);
B = labeloverlay(imgTest,C);
figure
imshow(B)
```

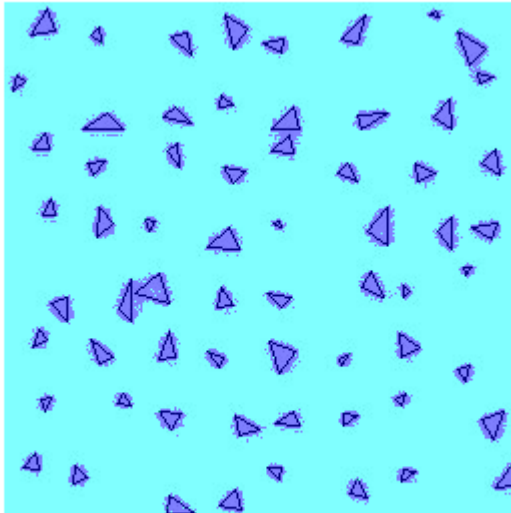

Tips

- The `pixelLabelDatastore` `pxds` and the `imageDatastore` `imds` store files that are located in a folder in lexicographical order. For example, if you have twelve files named 'file1.jpg', 'file2.jpg', ..., 'file11.jpg', and 'file12.jpg', then the files are stored in this order:

```
'file1.jpg'
'file10.jpg'
'file11.jpg'
'file12.jpg'
'file2.jpg'
'file3.jpg'
...
'file9.jpg'
```

Files that are stored in a cell array are read in the same order as they are stored.

If the order of files in `pxds` and `imds` are not the same, then you may encounter a mismatch when you read a ground truth image and corresponding label data using a `pixelLabelImageDatastore`. If this occurs, then rename the pixel label files so that they have the correct order. For example, rename 'file1.jpg', ..., 'file9.jpg' to 'file01.jpg', ..., 'file09.jpg'.

- To extract semantic segmentation data from a `groundTruth` object generated by the **Video Labeler**, use the `pixelLabelTrainingData` function.

See Also

Functions

trainNetwork

Objects

groundTruth | ImageDatastore | pixelLabelDatastore | pixelLabelTrainingData

Topics

“Getting Started with Semantic Segmentation Using Deep Learning”

“Datastores for Deep Learning” (Deep Learning Toolbox)

“Deep Learning in MATLAB” (Deep Learning Toolbox)

Introduced in R2018a

partitionByIndex

Partition pixelLabelImageDatastore according to indices

Syntax

```
pximds2 = partitionByIndex(pximds,ind)
```

Description

`pximds2 = partitionByIndex(pximds,ind)` partitions a subset of observations in a pixel label image datastore, `pximds`, into a new datastore, `pximds2`. The desired observations are specified by indices, `ind`.

Input Arguments

pximds — Pixel label image datastore

pixelLabelImageDatastore

Pixel label image datastore, specified as a pixelLabelImageDatastore object.

ind — Indices

vector of positive integers

Indices of observations, specified as a vector of positive integers.

Output Arguments

pximds2 — Output datastore

pixelLabelImageDatastore object

Output datastore, returned as a pixelLabelImageDatastore object containing a subset of files from `pximds`.

See Also

pixelLabelImageDatastore | readall | read | readByIndex

Introduced in R2018a

readByIndex

Read data specified by index from `pixelLabelImageDatastore`

Syntax

```
data = readByIndex(pximds,ind)
[data,info] = readByIndex(pximds,ind)
```

Description

`data = readByIndex(pximds,ind)` returns a subset of observations from a pixel label image datastore, `pximds`. The desired observations are specified by indices, `ind`.

`[data,info] = readByIndex(pximds,ind)` also returns information about the observations, including metadata, in `info`.

Input Arguments

pximds — Pixel label image datastore

`pixelLabelImageDatastore`

Pixel label image datastore, specified as a `pixelLabelImageDatastore` object.

ind — Indices

vector of positive integers

Indices of observations, specified as a vector of positive integers.

Output Arguments

data — Observations from datastore

table

Observations from the datastore, returned as a table with `length(ind)` number of rows.

info — Information about read data

structure array

Information about read data, returned as a structure array. The structure array can contain the following fields.

Field Name	Description
Filename	Filename is a fully resolved path containing the path string, name of the file, and file extension.
FileSize	Total file size, in bytes. For MAT-files, FileSize is the total number of key-value pairs in the file.

See Also

`pixelLabelImageDatastore` | `partitionByIndex` | `readall` | `read`

Introduced in R2018a

anchorBoxLayer

Create anchor box layer for object detection

Description

An anchor box layer stores anchor boxes for a feature map used in object detection networks.

Creation

Syntax

```
layer = anchorBoxLayer(anchorBoxes)
layer = anchorBoxLayer(anchorBoxes, Name, Value)
```

Description

`layer = anchorBoxLayer(anchorBoxes)` creates an anchor box layer, specifying the size of the anchor boxes by using `anchorBoxes`. The `anchorBoxes` input sets the `AnchorBoxes` property.

`layer = anchorBoxLayer(anchorBoxes, Name, Value)` set properties of the anchor box layer by using one or more name-value pair arguments. Enclose each property name in quotes.

For example, `anchorBoxLayer(anchorBoxes, 'Name', 'anchorboxlayer')` creates an anchor box layer with the name "anchorboxlayer" from anchor boxes specified by `anchorBoxes`.

Properties

AnchorBoxes — Size of anchor boxes

M-by-2 matrix

Size of anchor boxes, specified as an *M*-by-2 matrix of *M* anchor boxes. Each row of the matrix is of the form [*height width*].

Name — Layer name

' ' (default) | character vector | string scalar

Layer name, specified as a character vector or a string scalar. For `Layer` array input, the `trainNetwork`, `assembleNetwork`, `layerGraph`, and `dlnetwork` functions automatically assign names to layers with `Name` set to ' '.

Data Types: `char` | `string`

Examples

Create Anchor Box Layer

Specify the size of four anchor boxes.

```
anchorBoxes = [50 50; 100 100; 50 100; 100 50];
```

Create an anchor box layer named "anchorboxlayer" and display the results.

```
layer = anchorBoxLayer(anchorBoxes, 'Name', 'anchorboxlayer')
```

```
layer =  
    AnchorBoxLayer with properties:
```

```
        Name: 'anchorboxlayer'
```

```
    Hyperparameters
```

```
        AnchorBoxes: [4x2 double]
```

Extended Capabilities

GPU Code Generation

Generate CUDA® code for NVIDIA® GPUs using GPU Coder™.

To generate CUDA or C++ code by using GPU Coder™, you must first construct and train a deep neural network. Once the network is trained and evaluated, you can configure the code generator to generate code and deploy the convolutional neural network on platforms that use NVIDIA or ARM® GPU processors. For more information, see “Deep Learning with GPU Coder” (GPU Coder).

For this layer, you can generate code that takes advantage of the NVIDIA CUDA deep neural network library (cuDNN), NVIDIA TensorRT high performance inference library, or the ARM Compute Library for Mali GPU.

See Also

[trainNetwork](#) | [trainSSDObjectDetector](#)

Topics

[“Getting Started with Object Detection Using Deep Learning”](#)

[“Getting Started with SSD Multibox Detection”](#)

[“Anchor Boxes for Object Detection”](#)

[“List of Deep Learning Layers”](#) (Deep Learning Toolbox)

[“Deep Learning in MATLAB”](#) (Deep Learning Toolbox)

[“Specify Layers of Convolutional Neural Network”](#) (Deep Learning Toolbox)

Introduced in R2020a

dicePixelClassificationLayer

Create pixel classification layer using generalized Dice loss for semantic segmentation

Description

A Dice pixel classification layer provides a categorical label for each image pixel or voxel using generalized Dice loss.

The layer uses generalized Dice loss to alleviate the problem of class imbalance in semantic segmentation problems. Generalized Dice loss controls the contribution that each class makes to the loss by weighting classes by the inverse size of the expected region.

Creation

Syntax

```
layer = dicePixelClassificationLayer  
layer = dicePixelClassificationLayer(Name, Value)
```

Description

`layer = dicePixelClassificationLayer` creates a Dice pixel classification output layer for semantic image segmentation networks. The layer outputs the categorical label for each image pixel or voxel processed by a CNN. The layer automatically ignores undefined pixel labels during training.

`layer = dicePixelClassificationLayer(Name, Value)` returns a Dice pixel classification output layer using `Name, Value` pair arguments to set the optional `Classes` and `Name` properties. You can specify multiple name-value pairs. Enclose each property name in quotes.

For example, `dicePixelClassificationLayer('Name', 'pixclass')` creates a Dice pixel classification layer with the name `'pixclass'`.

Properties

Classes — Classes of the output layer

'auto' (default) | categorical vector | string array | cell array of character vectors

Classes of the output layer, specified as a categorical vector, string array, cell array of character vectors, or 'auto'. If `Classes` is 'auto', then the software automatically sets the classes at training time. If you specify the string array or cell array of character vectors `str`, then the software sets the classes of the output layer to `categorical(str, str)`.

Data Types: `char` | `categorical` | `string` | `cell`

OutputSize — Output size

'auto' (default)

This property is read-only.

The output size of the layer. The value is 'auto' prior to training, and is specified as a numeric value at training time.

LossFunction — Loss function

'generalizedDiceLoss' (default)

This property is read-only.

Loss function used for training, specified as 'generalizedDiceLoss'.

Name — Layer name

'' (default) | character vector | string scalar

Layer name, specified as a character vector or a string scalar. For Layer array input, the `trainNetwork`, `assembleNetwork`, `layerGraph`, and `dlnetwork` functions automatically assign names to layers with Name set to ''.

Data Types: char | string

NumInputs — Number of inputs

1 (default)

This property is read-only.

Number of inputs of the layer. This layer accepts a single input only.

Data Types: double

InputNames — Input names

{'in'} (default)

This property is read-only.

Input names of the layer. This layer accepts a single input only.

Data Types: cell

Examples

Create 2-D Semantic Segmentation Network with Dice Pixel Classification Layer

Predict the categorical label of every pixel in an input image using a generalized Dice loss function.

```
layers = [
    imageInputLayer([480 640 3])
    convolution2dLayer(3,16,'Stride',2,'Padding',1)
    reluLayer
    transposedConv2dLayer(2,4,'Stride',2)
    softmaxLayer
    dicePixelClassificationLayer
]
```

```
layers =
    6x1 Layer array with layers:
```

```
    1 '' Image Input
```

```
    480x640x3 images with 'zerocenter' normalization
```

2	''	Convolution	16 3x3 convolutions with stride [2 2] and padding
3	''	ReLU	ReLU
4	''	Transposed Convolution	4 2x2 transposed convolutions with stride [2 2]
5	''	Softmax	softmax
6	''	Dice Pixel Classification Layer	Generalized Dice loss

More About

Dice Loss

The Dice loss function is based on the Sørensen-Dice similarity coefficient for measuring overlap between two segmented images.

The generalized Dice loss function L used by `dicePixelClassificationLayer` for the loss between one image Y and the corresponding ground truth T is given by:

$$L = 1 - \frac{2 \sum_{k=1}^K w_k \sum_{m=1}^M Y_{km} T_{km}}{\sum_{k=1}^K w_k \sum_{m=1}^M Y_{km}^2 + T_{km}^2}$$

K is the number of classes, M is the number of elements along the first two dimensions of Y , and w_k is a class specific weighting factor that controls the contribution each class makes to the loss. This weighting helps counter the influence of larger regions on the Dice score, making it easier for the network to learn how to segment smaller regions. w_k is typically the inverse area of the expected region:

$$w_k = \frac{1}{\left(\sum_{m=1}^M T_{km}\right)^2}$$

There are several variations of generalized Dice Loss functions [1], [2]. The function used in `dicePixelClassificationLayer` has squared terms to ensure that the derivative is 0 when the prediction matches the ground truth [3].

References

- [1] Crum, William R., Oscar Camara, and Derek LG Hill. "Generalized overlap measures for evaluation and validation in medical image analysis." *IEEE Transactions on Medical Imaging*. 25.11, 2006, pp. 1451-1461.
- [2] Sudre, Carole H., et al. "Generalised Dice overlap as a deep learning loss function for highly unbalanced segmentations." *Deep Learning in Medical Image Analysis and Multimodal Learning for Clinical Decision Support*. Springer, Cham, 2017, pp. 240-248.
- [3] Milletari, Fausto, Nassir Navab, and Seyed-Ahmad Ahmadi. "V-Net: Fully Convolutional Neural Networks for Volumetric Medical Image Segmentation". *Fourth International Conference on 3D Vision (3DV)*. Stanford, CA, 2016: pp. 565-571.

Extended Capabilities

GPU Code Generation

Generate CUDA® code for NVIDIA® GPUs using GPU Coder™.

To generate CUDA or C++ code by using GPU Coder, you must first construct and train a deep neural network. Once the network is trained and evaluated, you can configure the code generator to generate code and deploy the convolutional neural network on platforms that use NVIDIA or ARM GPU processors. For more information, see “Deep Learning with GPU Coder” (GPU Coder).

For this layer, you can generate code that takes advantage of the NVIDIA CUDA deep neural network library (cuDNN), NVIDIA TensorRT high performance inference library, or the ARM Compute Library for Mali GPU.

See Also

[trainNetwork](#) | [semanticseg](#) | [pixelLabelImageDatastore](#) | [pixelLabelDatastore](#) | [fcnLayers](#) | [segnetLayers](#) | [pixelClassificationLayer](#)

Topics

“3-D Brain Tumor Segmentation Using Deep Learning”

“Getting Started with Semantic Segmentation Using Deep Learning”

“List of Deep Learning Layers” (Deep Learning Toolbox)

“Deep Learning in MATLAB” (Deep Learning Toolbox)

“Specify Layers of Convolutional Neural Network” (Deep Learning Toolbox)

Introduced in R2019b

focalLossLayer

Create focal loss layer using focal loss function

Description

A focal loss layer predicts object classes using focal loss. Add the focal loss layer to train an object detection, semantic segmentation, or a classification network when imbalance exists between foreground and background classes. To compensate for class imbalance, the focal loss function multiplies the cross entropy function with a modulating factor that increases the sensitivity of the network to misclassified observations.

Creation

Syntax

```
layer = focalLossLayer  
layer = focalLossLayer(Name, Value)
```

Description

`layer = focalLossLayer` creates a focal loss layer for deep learning networks. For information on how to use focal loss layer in an object detection network, see “Create SSD Object Detection Network”.

`layer = focalLossLayer(Name, Value)` sets properties of the focal loss layer by using one or more name-value pair arguments. Enclose each property name in quotes.

For example, `focalLossLayer('Name', 'focalloss')` creates a focal loss layer with the name 'focalloss' and the specified balancing and focusing parameters.

Properties

Alpha — Balancing parameter

0.25 (default) | positive real number

Balancing parameter of the focal loss function, specified as a positive real number. The Alpha value scales the loss function linearly and is typically set to 0.25. If you decrease Alpha, increase Gamma.

Gamma — Focusing parameter

2.0 (default) | positive real number

Focusing parameter of the focal loss function, specified as a positive real number. Increasing the value of Gamma increases the sensitivity of the network to misclassified observations.

Classes — Object classes to detect

'auto' (default) | string vector | categorical vector | cell array of character vectors

Object classes that the network is trained to detect, specified as a string vector, categorical vector, cell array of character vectors, or 'auto'. When you set `Classes` to 'auto', the classes are automatically set at training time. When you specify a string vector or cell array of character vectors, then the elements of `Classes` are sorted according to the output of the `categories` function.

Data Types: string | categorical | cell | char

Name — Layer name

' ' (default) | character vector | string scalar

Layer name, specified as a character vector or a string scalar. For `Layer` array input, the `trainNetwork`, `assembleNetwork`, `layerGraph`, and `dlnetwork` functions automatically assign names to layers with `Name` set to ' '.

Data Types: char | string

Examples

Create Focal Loss Layer

Specify class names.

```
classes = ["Vehicle", "Background"];
```

Specify the balancing parameter, and focusing parameter of the focal loss function. Create a focal loss layer named "focallosslayer" for the two classes, displaying results.

```
layer = focalLossLayer('Classes', classes, 'Name', 'focallosslayer')
```

```
layer =
  FocalLossLayer with properties:
      Name: 'focallosslayer'

  Hyperparameters
      Gamma: 2
      Alpha: 0.2500
      Classes: [2x1 categorical]
      LossFunction: 'focalLoss'
```

Create 2-D Semantic Segmentation Network with Focal Loss Layer

Create a DeepLab v3+ network based on ResNet-18.

```
imageSize = [480 640 3];
numClasses = 5;
network = 'resnet18';
lgraph = deeplabv3plusLayers(imageSize, numClasses, network, 'DownsamplingFactor', 16)
```

```
lgraph =
  LayerGraph with properties:
      Layers: [100x1 nnet.cnn.layer.Layer]
```

```
Connections: [113x2 table]
InputNames: {'data'}
OutputNames: {'classification'}
```

Display the output layer of the network. The output layer of the DeepLab v3+ network is a `Pixel Classification Layer` that uses cross-entropy loss to predict the categorical label for every pixel in an input 2-D image.

```
lgraph.Layers(end)
```

```
ans =
  PixelClassificationLayer with properties:
      Name: 'classification'
      Classes: 'auto'
      ClassWeights: 'none'
      OutputSize: 'auto'

  Hyperparameters
      LossFunction: 'crossentropyex'
```

Replace the output `Pixel Classification Layer` with the `Focal Loss Layer` to handle imbalanced classes in data.

```
layer = focalLossLayer("Name","focalloss");
lgraph = replaceLayer(lgraph,"classification",layer);
```

Display the network.

```
analyzeNetwork(lgraph);
```

Create 3-D Semantic Segmentation Network with Focal Loss Layer

Create a 3-D U-Net network for semantic segmentation by using `UNET3DLayers` function. Set the encoder-decoder depth to 2 and specify the number of output channels for the first convolution layer as 16.

```
imageSize = [128 128 128 3];
numClasses = 5;
lgraph = unet3dLayers(imageSize,numClasses,'EncoderDepth',2,...
                    'NumFirstEncoderFilters',16);
figure
plot(lgraph)
```

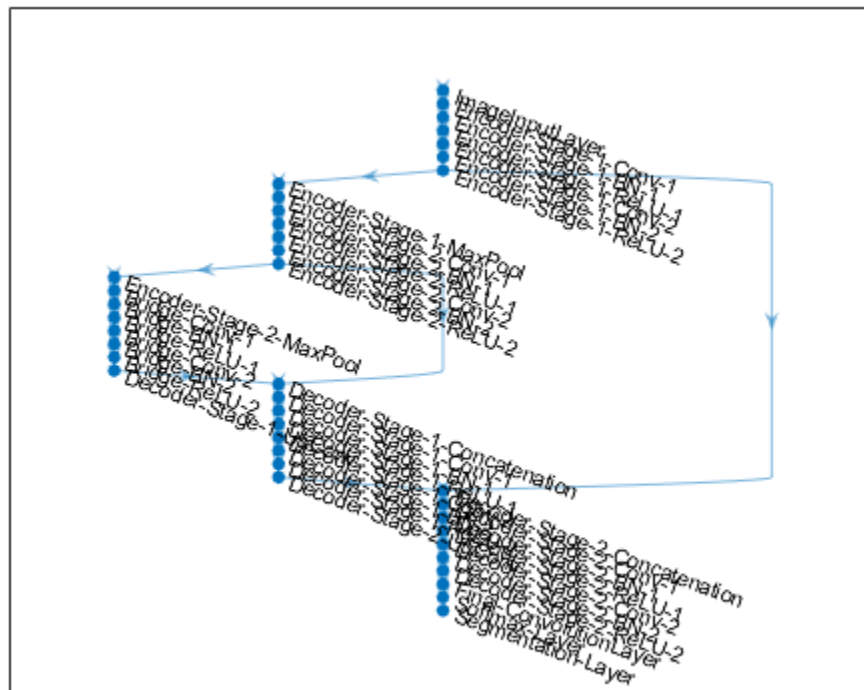

Create a focal loss layer and replace the Segmentation-Layer in the network with the focal loss layer. The layer predicts the categorical label for every voxel in an input 3-D volume.

```
layer = focalLossLayer("Name", "focalloss");
lgraph = replaceLayer(lgraph, "Segmentation-Layer", layer)
```

```
lgraph =
  LayerGraph with properties:
    Layers: [40x1 nnet.cnn.layer.Layer]
    Connections: [41x2 table]
    InputNames: {'ImageInputLayer'}
    OutputNames: {'focalloss'}
```

Display the network.

```
analyzeNetwork(lgraph);
```

More About

Focal Loss

The focal loss function is based on cross-entropy loss. Focal loss compensates for class imbalance by using a modulating factor that emphasizes hard negatives during training.

The focal loss function, L , used by the `focalLossLayer` object for the loss between one image Y and the corresponding ground truth T is given by:

$$L = -\frac{1}{M} \sum_{m=1}^M \sum_{k=1}^K T_{mk} \alpha (1 - Y_{mk})^\gamma \ln(Y_{mk})$$

K is the number of classes. M is the number of observations, which is typically the number of elements along the first two dimensions of Y multiplied by the number of anchor boxes. The function used by the `focalLossLayer` object ensures that the input to the natural logarithm is greater than 0.

References

- [1] Lin, Tsung-Yi, Priya Goyal, Ross Girshick, Kaiming He, and Piotr Dollar. "Focal Loss for Dense Object Detection." In *2017 IEEE® International Conference on Computer Vision (ICCV), 2999-3007*. Venice: IEEE, 2017. <https://doi.org/10.1109/ICCV.2017.324>.

Extended Capabilities

GPU Code Generation

Generate CUDA® code for NVIDIA® GPUs using GPU Coder™.

To generate CUDA or C++ code by using GPU Coder, you must first construct and train a deep neural network. Once the network is trained and evaluated, you can configure the code generator to generate code and deploy the convolutional neural network on platforms that use NVIDIA or ARM GPU processors. For more information, see "Deep Learning with GPU Coder" (GPU Coder).

For this layer, you can generate code that takes advantage of the NVIDIA CUDA deep neural network library (cuDNN), NVIDIA TensorRT high performance inference library, or the ARM Compute Library for Mali GPU.

See Also

`trainNetwork` | `trainSSDObjectDetector` | `focalCrossEntropy`

Topics

"Getting Started with Object Detection Using Deep Learning"

"Getting Started with SSD Multibox Detection"

"List of Deep Learning Layers" (Deep Learning Toolbox)

"Deep Learning in MATLAB" (Deep Learning Toolbox)

"Specify Layers of Convolutional Neural Network" (Deep Learning Toolbox)

Introduced in R2020a

pixelClassificationLayer

Create pixel classification layer for semantic segmentation

Description

A pixel classification layer provides a categorical label for each image pixel or voxel.

Creation

Syntax

```
layer = pixelClassificationLayer
layer = pixelClassificationLayer(Name,Value)
```

Description

`layer = pixelClassificationLayer` creates a pixel classification output layer for semantic image segmentation networks. The layer outputs the categorical label for each image pixel or voxel processed by a CNN. The layer automatically ignores undefined pixel labels during training.

`layer = pixelClassificationLayer(Name,Value)` returns a pixel classification output layer using `Name,Value` pair arguments to set the optional `Classes`, `ClassWeights`, and `Name` properties by using name-value pairs. You can specify multiple name-value pairs. Enclose each property name in quotes.

For example, `pixelClassificationLayer('Name','pixclass')` creates a pixel classification layer with the name 'pixclass'.

Properties

Classes — Classes of the output layer

'auto' (default) | categorical vector | string array | cell array of character vectors

Classes of the output layer, specified as a categorical vector, string array, cell array of character vectors, or 'auto'. If `Classes` is 'auto', then the software automatically sets the classes at training time. If you specify the string array or cell array of character vectors `str`, then the software sets the classes of the output layer to `categorical(str,str)`.

Data Types: `char` | `categorical` | `string` | `cell`

ClassWeights — Class weights

'none' (default) | vector of real scalar

Class weights, specified as 'none' or as a vector of real scalar. The elements of the vector correspond to the classes in `Classes`. If you specify `ClassWeights`, then you must specify `Classes`.

Use class weighting to balance classes when there are underrepresented classes in the training data.

OutputSize — Output size`'auto'` (default)

This property is read-only.

The output size of the layer. The value is `'auto'` prior to training, and is specified as a numeric value at training time.

LossFunction — Loss function`'crossentropyex'` (default)

This property is read-only.

Loss function used for training, specified as `'crossentropyex'`.

Name — Layer name`''` (default) | character vector | string scalar

Layer name, specified as a character vector or a string scalar. For Layer array input, the `trainNetwork`, `assembleNetwork`, `layerGraph`, and `dlnetwork` functions automatically assign names to layers with Name set to `''`.

Data Types: `char` | `string`

NumInputs — Number of inputs`1` (default)

This property is read-only.

Number of inputs of the layer. This layer accepts a single input only.

Data Types: `double`

InputNames — Input names`{'in'}` (default)

This property is read-only.

Input names of the layer. This layer accepts a single input only.

Data Types: `cell`

Examples

Use Pixel Classification Layer to Create Semantic Segmentation Network

Predict the categorical label of every pixel in an input image.

```
layers = [  
    imageInputLayer([32 32 3])  
    convolution2dLayer(3,16,'Stride',2,'Padding',1)  
    reluLayer  
    transposedConv2dLayer(3,1,'Stride',2,'Cropping',1)  
    softmaxLayer  
    pixelClassificationLayer  
]
```

```

layers =
    6x1 Layer array with layers:

    1 '' Image Input          32x32x3 images with 'zerocenter' normalization
    2 '' Convolution         16 3x3 convolutions with stride [2 2] and padding [1
    3 '' ReLU                 ReLU
    4 '' Transposed Convolution 1 3x3 transposed convolutions with stride [2 2] and
    5 '' Softmax              softmax
    6 '' Pixel Classification Layer Cross-entropy loss

```

Use Weighting to Balance Classes in Training Data

Balance classes using inverse class frequency weighting when some classes are underrepresented in the training data. First, count class frequencies over the training data using `pixelLabelDatastore`. Then, set the 'ClassWeights' in `pixelClassificationLayer` to the computed inverse class frequencies.

Set the location of image and pixel label data.

```

dataDir = fullfile(toolboxdir('vision'),'visiondata');
imDir = fullfile(dataDir,'building');
pxDir = fullfile(dataDir,'buildingPixelLabels');

```

Create a pixel label image datastore using the ground truth images in `imds` and the pixel labeled images in `pxds`.

```

imds = imageDatastore(imDir);
classNames = ["sky" "grass" "building" "sidewalk"];
pixelLabelID = [1 2 3 4];
pxds = pixelLabelDatastore(pxDir,classNames,pixelLabelID);

```

Tabulate class distribution in dataset.

```
tbl = countEachLabel(pxds)
```

```
tbl=4x3 table
      Name      PixelCount      ImagePixelCount
      _____  _____  _____
      {'sky'     }      3.1485e+05      1.536e+06
      {'grass'   }      1.5979e+05      1.536e+06
      {'building'}      1.0312e+06      1.536e+06
      {'sidewalk'}      25313          9.216e+05
```

Calculate inverse frequency class weights.

```

totalNumberOfPixels = sum(tbl.PixelCount);
frequency = tbl.PixelCount / totalNumberOfPixels;
inverseFrequency = 1./frequency

```

```
inverseFrequency = 4x1
```

```

4.8632
9.5827
1.4848

```

```
60.4900
```

Set 'ClassWeights' to the inverse class frequencies.

```
layer = pixelClassificationLayer(...  
    'Classes',tbl.Name,'ClassWeights',inverseFrequency)  
  
layer =  
PixelClassificationLayer with properties:  
  
    Name: ''  
    Classes: [sky    grass    building    sidewalk]  
    ClassWeights: [4x1 double]  
    OutputSize: 'auto'  
  
Hyperparameters  
    LossFunction: 'crossentropyex'
```

Extended Capabilities

GPU Code Generation

Generate CUDA® code for NVIDIA® GPUs using GPU Coder™.

To generate CUDA or C++ code by using GPU Coder, you must first construct and train a deep neural network. Once the network is trained and evaluated, you can configure the code generator to generate code and deploy the convolutional neural network on platforms that use NVIDIA or ARM GPU processors. For more information, see “Deep Learning with GPU Coder” (GPU Coder).

For this layer, you can generate code that takes advantage of the NVIDIA CUDA deep neural network library (cuDNN), NVIDIA TensorRT high performance inference library, or the ARM Compute Library for Mali GPU.

See Also

Objects

[layerGraph](#) | [DAGNetwork](#) | [dicePixelClassificationLayer](#)

Functions

[fcnLayers](#) | [segnetLayers](#) | [UNETLayers](#) | [trainNetwork](#) | [semanticseg](#) | [deeplabv3plusLayers](#) | [evaluateSemanticSegmentation](#)

Topics

“Getting Started with Semantic Segmentation Using Deep Learning”

“Deep Learning in MATLAB” (Deep Learning Toolbox)

“Specify Layers of Convolutional Neural Network” (Deep Learning Toolbox)

Introduced in R2017b

rcnnBoxRegressionLayer

Box regression layer for Fast and Faster R-CNN

Description

A box regression layer refines bounding box locations by using a smooth L1 loss function. Use this layer to create a Fast or Faster R-CNN object detection network.

Creation

Syntax

```
layer = rcnnBoxRegressionLayer  
layer = rcnnBoxRegressionLayer('Name',Name)
```

Description

`layer = rcnnBoxRegressionLayer` creates a box regression layer for a Fast or Faster R-CNN object detection network.

`layer = rcnnBoxRegressionLayer('Name',Name)` creates a box regression layer and sets the optional `Name` property.

Properties

Name — Layer name

' ' (default) | character vector | string scalar

Layer name, specified as a character vector or a string scalar. For `Layer` array input, the `trainNetwork`, `assembleNetwork`, `layerGraph`, and `dlnetwork` functions automatically assign names to layers with `Name` set to ' '.

Data Types: `char` | `string`

NumInputs — Number of inputs

1 (default)

This property is read-only.

Number of inputs of the layer. This layer accepts a single input only.

Data Types: `double`

InputNames — Input names

{'in'} (default)

This property is read-only.

Input names of the layer. This layer accepts a single input only.

Data Types: cell

Examples

Create R-CNN Box Regression Layer

Create an R-CNN box regression layer with the name 'rcnn_box_reg'.

```
rcnnBoxRegression = rcnnBoxRegressionLayer('Name','rcnn_box_reg');
```

Extended Capabilities

GPU Code Generation

Generate CUDA® code for NVIDIA® GPUs using GPU Coder™.

To generate CUDA or C++ code by using GPU Coder, you must first construct and train a deep neural network. Once the network is trained and evaluated, you can configure the code generator to generate code and deploy the convolutional neural network on platforms that use NVIDIA or ARM GPU processors. For more information, see “Deep Learning with GPU Coder” (GPU Coder).

For this layer, you can generate code that takes advantage of the NVIDIA CUDA deep neural network library (cuDNN), NVIDIA TensorRT high performance inference library, or the ARM Compute Library for Mali GPU.

See Also

[trainFasterRCNNObjectDetector](#) | [trainFastRCNNObjectDetector](#) | [regressionLayer](#)

Topics

“Create Fast R-CNN Object Detection Network”

“Create Faster R-CNN Object Detection Network”

“Getting Started with R-CNN, Fast R-CNN, and Faster R-CNN”

“Deep Learning in MATLAB” (Deep Learning Toolbox)

“List of Deep Learning Layers” (Deep Learning Toolbox)

Introduced in R2018b

regionProposalLayer

Region proposal layer for Faster R-CNN

Description

A region proposal layer outputs bounding boxes around potential objects in an image as part of the region proposal network (RPN) within Faster R-CNN. These outputs are further refined by additional layers within Faster R-CNN to produce the final object detection results.

There are two inputs to this layer:

- 'scores' — The classification scores produced by the RPN classification branch
- 'boxDeltas' — The bounding box deltas produced by the RPN regression branch

Use the input names when connecting or disconnecting the region proposal layer to other layers using `connectLayers` or `disconnectLayers` (requires Deep Learning Toolbox).

Creation

Syntax

```
layer = regionProposalLayer(anchorBoxes)
layer = regionProposalLayer(anchorBoxes, 'Name', Name)
```

Description

`layer = regionProposalLayer(anchorBoxes)` creates a region proposal layer for building Faster R-CNN object detection networks, and sets the `AnchorBoxes` property.

`layer = regionProposalLayer(anchorBoxes, 'Name', Name)` creates a region proposal layer and sets the optional `Name` property.

Properties

AnchorBoxes — Anchor boxes

M-by-2 matrix

Anchor boxes, specified as an *M*-by-2 matrix defining the [*height width*] of *M* anchor boxes.

Anchor boxes are predefined bounding box templates of fixed size. The size of each anchor box is typically determined based on a priori knowledge of the scale and aspect ratio of objects in the training dataset. An RPN network is trained to predict the translation and rescaling needed to align the anchor boxes with the ground truth bounding boxes. [1]

Name — Layer name

' ' (default) | character vector | string scalar

Layer name, specified as a character vector or a string scalar. For Layer array input, the `trainNetwork`, `assembleNetwork`, `layerGraph`, and `dlnetwork` functions automatically assign names to layers with `Name` set to ''.

Data Types: `char` | `string`

NumInputs — Number of inputs

2 (default)

Number of inputs of the layer. This layer has two inputs.

Data Types: `double`

InputNames — Input names

{'scores' 'boxDeltas'} (default)

Input names of the layer. This layer has two inputs, named 'scores' and 'boxDeltas'.

Data Types: `cell`

NumOutputs — Number of outputs

1 (default)

This property is read-only.

Number of outputs of the layer. This layer has a single output only.

Data Types: `double`

OutputNames — Output names

{'out'} (default)

This property is read-only.

Output names of the layer. This layer has a single output only.

Data Types: `cell`

Examples

Create Region Proposal Layer

Define three square anchor boxes for the region proposal layer.

```
anchorBoxes = [  
    16 16  
    64 64  
    128 128  
    ];
```

Create a region proposal layer with the name 'region_proposal'.

```
regionProposal = regionProposalLayer(anchorBoxes, 'Name', 'region_proposal');
```

References

- [1] Ren, S., K. He, R. Girshick, and J. Sun. "Faster R-CNN: Towards Real-Time Object Detection with Region Proposal Networks." *Advances in Neural Information Processing Systems*. Vol. 28, 2015.

See Also

`trainFasterRCNNObjectDetector` | `layerGraph` | `connectLayers` | `removeLayers`

Topics

"Create Faster R-CNN Object Detection Network"

"Getting Started with R-CNN, Fast R-CNN, and Faster R-CNN"

"Deep Learning in MATLAB" (Deep Learning Toolbox)

"List of Deep Learning Layers" (Deep Learning Toolbox)

Introduced in R2018b

roiAlignLayer

Non-quantized ROI pooling layer for Mask-CNN

Description

An ROI align layer outputs fixed size feature maps for every rectangular ROI within an input feature map. Use this layer to create a Mask R-CNN network.

Given an input feature map of size $[H W C N]$, where C is the number of channels and N is the number of observations, the output feature map size is $[h w C \text{sum}(M)]$, where h and w are the specified output size. M is a vector of length N and $M(i)$ is the number of ROIs associated with the i -th input feature map.

There are two inputs to this layer:

- 'in' — The input feature map
- 'roi' — A list of ROIs to pool

Use the input names when connecting or disconnecting the ROI align layer to other layers using `connectLayers` or `disconnectLayers` (requires Deep Learning Toolbox).

Creation

Syntax

```
layer = roiAlignLayer(outputSize)  
layer = roiAlignLayer(outputSize,Name,Value)
```

Description

`layer = roiAlignLayer(outputSize)` creates an ROI align layer with pooled output size `outputSize`. The `outputSize` input sets the `OutputSize` property.

`layer = roiAlignLayer(outputSize,Name,Value)` set properties of the ROI align layer by using one or more name-value pair arguments. Enclose each property name in quotes.

For example, `roiAlignLayer([7 7], 'Name', 'roialignlayer')` creates an ROI align layer with a pooled output size of 7-by-7 pixels and name 'roialignlayer'.

Properties

OutputSize — Pooled output size

vector of two positive integers

Pooled output size, specified as a vector of two positive integers $[h w]$, where h is the height and w is the width.

Data Types: double

ROIScale — Scale of input feature map to input image

1 (default) | positive number

Scale of the input feature map to the input image, specified as a positive number.

Data Types: double

SamplingRatio — Number of samples in each pooled bin

'auto' (default) | row vector of two positive integers

Number of samples in each pooled bin, specified as 'auto' or a row vector of two positive integers. The two elements are the number of vertical and horizontal samples, respectively.

If you do not specify the sampling ratio, then the number of vertical samples has the default value `ceil(roiHeight/outputHeight)`. Likewise, the number of horizontal samples has the default value `ceil(roiWidth/outputWidth)`.

Data Types: double | char

Name — Layer name

' ' (default) | character vector | string scalar

Layer name, specified as a character vector or a string scalar. For Layer array input, the `trainNetwork`, `assembleNetwork`, `layerGraph`, and `dlnetwork` functions automatically assign names to layers with Name set to ' '.

Data Types: char | string

NumInputs — Number of inputs

2 (default)

Number of inputs of the layer. This layer accepts two inputs.

Data Types: double

InputNames — Input names

{'in' 'roi'} (default)

Input names of the layer.

Data Types: cell

NumOutputs — Number of outputs

1 (default)

This property is read-only.

Number of outputs of the layer. This layer has a single output only.

Data Types: double

OutputNames — Output names

{'out'} (default)

This property is read-only.

Output names of the layer. This layer has a single output only.

Data Types: cell

Examples

Create ROI Align Layer

Specify the pooled output size.

```
outputSize = [7 7];
```

Create an ROI align layer named 'roialign'.

```
layer = roiAlignLayer(outputSize, 'Name', 'roialign')
```

```
layer =  
    ROIAlignLayer with properties:
```

```
        Name: 'roialign'  
    NumInputs: 2  
    InputNames: {'in' 'roi'}  
    OutputSize: [7 7]
```

```
Hyperparameters
```

```
    ROIScale: 1  
    SamplingRatio: 'auto'
```

More About

ROI Align Layer

An ROI align layer outputs fixed size feature maps for every rectangular ROI within an input feature map. The layer first partitions an ROI into fixed sized bins of size `OutputSize` without quantizing the grid points. Each bin is further sampled at `SamplingRatio` locations. The value at each sampled point is inferred using bilinear interpolation. The average of the sampled values is returned as the output value of each pooled bin.

See Also

[roiMaxPooling2dLayer](#) | [trainFastRCNNObjectDetector](#) | [trainFasterRCNNObjectDetector](#)

Topics

“Getting Started with Object Detection Using Deep Learning”
“Getting Started with R-CNN, Fast R-CNN, and Faster R-CNN”
“Deep Learning in MATLAB” (Deep Learning Toolbox)
“List of Deep Learning Layers” (Deep Learning Toolbox)

Introduced in R2020b

roiInputLayer

ROI input layer for Fast R-CNN

Description

An ROI input layer inputs images to a Fast R-CNN object detection network.

Creation

Syntax

```
layer = roiInputLayer  
layer = roiInputLayer('Name',Name)
```

Description

`layer = roiInputLayer` creates an ROI input layer.

`layer = roiInputLayer('Name',Name)` creates an ROI input layer and sets the optional `Name` property.

Properties

Name — Layer name

`''` (default) | character vector | string scalar

Layer name, specified as a character vector or a string scalar. For Layer array input, the `trainNetwork`, `assembleNetwork`, `layerGraph`, and `dlnetwork` functions automatically assign names to layers with `Name` set to `''`.

Data Types: `char` | `string`

NumOutputs — Number of outputs

1 (default)

This property is read-only.

Number of outputs of the layer. This layer has a single output only.

Data Types: `double`

OutputNames — Output names

`{'out'}` (default)

This property is read-only.

Output names of the layer. This layer has a single output only.

Data Types: `cell`

Examples

Connect ROI Input Layer to ROI Max Pooling Layer

Create an ROI input layer.

```
roiInput = roiInputLayer('Name','roi_input');
```

Create an ROI max pooling layer with output size [4 4].

```
outputSize = [4 4];  
roiPool = roiMaxPooling2dLayer(outputSize,'Name','roi_pool');
```

Add the layers to a LayerGraph.

```
lgraph = layerGraph;  
lgraph = addLayers(lgraph,roiInput);  
lgraph = addLayers(lgraph,roiPool);
```

Specify that the output of the ROI input layer is the 'roi' input of the ROI max pooling layer.

```
lgraph = connectLayers(lgraph,'roi_input','roi_pool/roi');  
plot(lgraph)
```

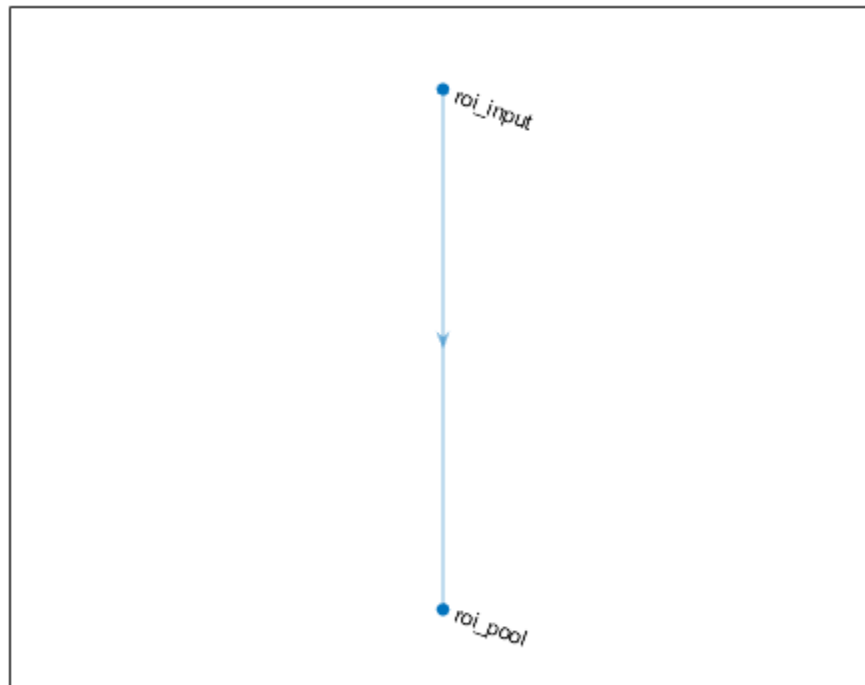

See Also

[trainFastRCNNObjectDetector](#) | [roiMaxPooling2dLayer](#) | [imageInputLayer](#)

Topics

[“Create Fast R-CNN Object Detection Network”](#)

[“Getting Started with R-CNN, Fast R-CNN, and Faster R-CNN”](#)

[“Deep Learning in MATLAB”](#) (Deep Learning Toolbox)

[“List of Deep Learning Layers”](#) (Deep Learning Toolbox)

Introduced in R2018b

roiMaxPooling2dLayer

Neural network layer used to output fixed-size feature maps for rectangular ROIs

Description

An ROI max pooling layer outputs fixed size feature maps for every rectangular ROI within the input feature map. Use this layer to create a Fast or Faster R-CNN object detection network.

Given an input feature map of size $[H W C N]$, where C is the number of channels and N is the number of observations, the output feature map size is $[height width C \sum(M)]$, where $height$ and $width$ are the output size. M is a vector of length N and $M(i)$ is the number of ROIs associated with the i -th input feature map.

There are two inputs to this layer:

- 'in' — The input feature map that will be cropped
- 'roi' — A list of ROIs to pool

Use the input names when connecting or disconnecting the ROI max pooling layer to other layers using `connectLayers` or `disconnectLayers` (requires Deep Learning Toolbox).

Creation

Syntax

```
layer = roiMaxPooling2dLayer(outputSize)
layer = roiMaxPooling2dLayer(outputSize, 'Name', Name)
```

Description

`layer = roiMaxPooling2dLayer(outputSize)` creates a max pooling layer for ROIs and sets the `OutputSize` property.

`layer = roiMaxPooling2dLayer(outputSize, 'Name', Name)` creates a max pooling layer for ROIs and sets the optional `Name` property. To create a network containing an ROI max pooling layer, you must specify a layer name.

Properties

OutputSize — Pooled output size

two-element vector of positive integers

Pooled output size, specified as a two-element vector of positive integers of the form $[height width]$.

Name — Layer name

' ' (default) | character vector | string scalar

Layer name, specified as a character vector or a string scalar. For Layer array input, the `trainNetwork`, `assembleNetwork`, `layerGraph`, and `dlnetwork` functions automatically assign names to layers with `Name` set to ''.

Data Types: `char` | `string`

NumInputs — Number of inputs

2 (default)

Number of inputs of the layer. This layer has two inputs.

Data Types: `double`

InputNames — Input names

{'in' 'roi'} (default)

Input names of the layer. This layer has two inputs, named 'in' and 'roi'.

Data Types: `cell`

NumOutputs — Number of outputs

1 (default)

This property is read-only.

Number of outputs of the layer. This layer has a single output only.

Data Types: `double`

OutputNames — Output names

{'out'} (default)

This property is read-only.

Output names of the layer. This layer has a single output only.

Data Types: `cell`

Examples

Connect ROI Input Layer to ROI Max Pooling Layer

Create an ROI input layer.

```
roiInput = roiInputLayer('Name','roi_input');
```

Create an ROI max pooling layer with output size [4 4].

```
outputSize = [4 4];
roiPool = roiMaxPooling2dLayer(outputSize,'Name','roi_pool');
```

Add the layers to a LayerGraph.

```
lgraph = layerGraph;
lgraph = addLayers(lgraph,roiInput);
lgraph = addLayers(lgraph,roiPool);
```

Specify that the output of the ROI input layer is the ' roi ' input of the ROI max pooling layer.

```
lgraph = connectLayers(lgraph, 'roi_input', 'roi_pool/roi');  
plot(lgraph)
```

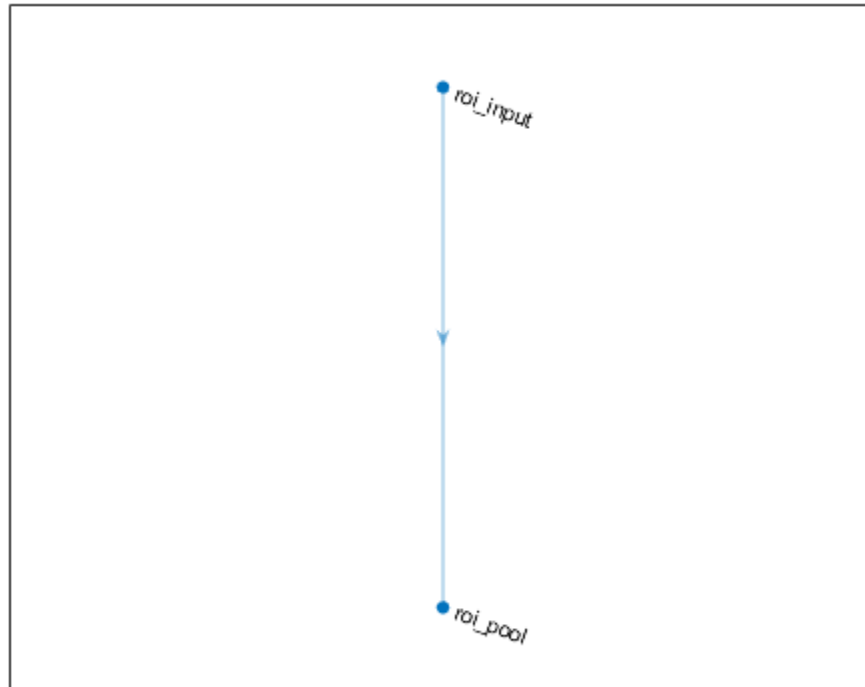

See Also

[trainFastRCNNObjectDetector](#) | [trainFasterRCNNObjectDetector](#) | [roiInputLayer](#) | [maxPooling2dLayer](#) | [layerGraph](#) | [connectLayers](#) | [removeLayers](#)

Topics

“Create Fast R-CNN Object Detection Network”
“Create Faster R-CNN Object Detection Network”
“Getting Started with R-CNN, Fast R-CNN, and Faster R-CNN”
“Deep Learning in MATLAB” (Deep Learning Toolbox)
“List of Deep Learning Layers” (Deep Learning Toolbox)

Introduced in R2018b

rpnClassificationLayer

Classification layer for region proposal networks (RPNs)

Description

A region proposal network (RPN) classification layer classifies image regions as either *object* or *background* by using a cross entropy loss function. Use this layer to create a Faster R-CNN object detection network.

Creation

Syntax

```
layer = rpnClassificationLayer
layer = rpnClassificationLayer('Name',Name)
```

Description

`layer = rpnClassificationLayer` creates a two-class classification layer for a Faster R-CNN object detection network.

`layer = rpnClassificationLayer('Name',Name)` creates a two-class classification layer and sets the optional Name property.

Properties

Name — Layer name

' ' (default) | character vector | string scalar

Layer name, specified as a character vector or a string scalar. For Layer array input, the `trainNetwork`, `assembleNetwork`, `layerGraph`, and `dlnetwork` functions automatically assign names to layers with Name set to ' '.

Data Types: `char` | `string`

NumInputs — Number of inputs

1 (default)

This property is read-only.

Number of inputs of the layer. This layer accepts a single input only.

Data Types: `double`

InputNames — Input names

{'in'} (default)

This property is read-only.

Input names of the layer. This layer accepts a single input only.

Data Types: cell

Examples

Create Classification Branch of RPN

Create an RPN softmax layer with the name 'rpn_softmax'.

```
rpnSoftmax = rpnSoftmaxLayer('Name','rpn_softmax')
```

```
rpnSoftmax =
  RPNSoftmaxLayer with properties:
```

```
    Name: 'rpn_softmax'
```

Create an RPN classification layer with the name 'rpn_cls'.

```
rpnClassification = rpnClassificationLayer('Name','rpn_cls')
```

```
rpnClassification =
  RPNClassificationLayer with properties:
```

```
    Name: 'rpn_cls'
```

Add the RPN softmax and RPN classification layers to a Layer array, to form the classification branch of an RPN.

```
numAnchors = 3;
rpnClassLayers = [
    convolution2dLayer(1,numAnchors*2,'Name','conv1x1_box_cls')
    rpnSoftmax
    rpnClassification
]
```

```
rpnClassLayers =
  3x1 Layer array with layers:
```

1	'conv1x1_box_cls'	Convolution	6 1x1 convolutions with stride [1 1] and
2	'rpn_softmax'	RPN Softmax	rpn softmax
3	'rpn_cls'	RPN Classification Output	cross-entropy loss with 'object' and 'ba

See Also

[trainFasterRCNNObjectDetector](#) | [classificationLayer](#) | [rpnSoftmaxLayer](#)

Topics

“Create Faster R-CNN Object Detection Network”

“Getting Started with R-CNN, Fast R-CNN, and Faster R-CNN”

“Deep Learning in MATLAB” (Deep Learning Toolbox)

“List of Deep Learning Layers” (Deep Learning Toolbox)

Introduced in R2018b

rpnSoftmaxLayer

Softmax layer for region proposal network (RPN)

Description

A region proposal network (RPN) softmax layer applies a softmax activation function to the input. Use this layer to create a Faster R-CNN object detection network.

Creation

Syntax

```
layer = rpnSoftmaxLayer  
layer = rpnSoftmaxLayer('Name',Name)
```

Description

`layer = rpnSoftmaxLayer` creates a softmax layer for a Faster R-CNN object detection network.

`layer = rpnSoftmaxLayer('Name',Name)` creates a softmax layer and sets the optional `Name` property.

Properties

Name — Layer name

' ' (default) | character vector | string scalar

Layer name, specified as a character vector or a string scalar. For `Layer` array input, the `trainNetwork`, `assembleNetwork`, `layerGraph`, and `dlnetwork` functions automatically assign names to layers with `Name` set to ' '.

Data Types: `char` | `string`

NumInputs — Number of inputs

1 (default)

This property is read-only.

Number of inputs of the layer. This layer accepts a single input only.

Data Types: `double`

InputNames — Input names

{'in'} (default)

This property is read-only.

Input names of the layer. This layer accepts a single input only.

Data Types: cell

NumOutputs — Number of outputs

1 (default)

This property is read-only.

Number of outputs of the layer. This layer has a single output only.

Data Types: double

OutputNames — Output names

{ 'out' } (default)

This property is read-only.

Output names of the layer. This layer has a single output only.

Data Types: cell

Examples

Create Classification Branch of RPN

Create an RPN softmax layer with the name 'rpn_softmax'.

```
rpnSoftmax = rpnSoftmaxLayer('Name', 'rpn_softmax')
```

```
rpnSoftmax =  
  RPNSoftmaxLayer with properties:
```

```
  Name: 'rpn_softmax'
```

Create an RPN classification layer with the name 'rpn_cls'.

```
rpnClassification = rpnClassificationLayer('Name', 'rpn_cls')
```

```
rpnClassification =  
  RPNClassificationLayer with properties:
```

```
  Name: 'rpn_cls'
```

Add the RPN softmax and RPN classification layers to a Layer array, to form the classification branch of an RPN.

```
numAnchors = 3;  
rpnClassLayers = [  
  convolution2dLayer(1, numAnchors*2, 'Name', 'conv1x1_box_cls')  
  rpnSoftmax  
  rpnClassification  
]
```

```
rpnClassLayers =  
  3x1 Layer array with layers:
```

1	'conv1x1_box_cls'	Convolution	6 1x1 convolutions with stride [1 1] and
2	'rpn_softmax'	RPN Softmax	rpn softmax
3	'rpn_cls'	RPN Classification Output	cross-entropy loss with 'object' and 'background'

See Also

[trainFasterRCNNObjectDetector](#) | [rpnClassificationLayer](#) | [softmaxLayer](#)

Topics

[“Create Faster R-CNN Object Detection Network”](#)

[“Getting Started with R-CNN, Fast R-CNN, and Faster R-CNN”](#)

[“Deep Learning in MATLAB”](#) (Deep Learning Toolbox)

[“List of Deep Learning Layers”](#) (Deep Learning Toolbox)

Introduced in R2018b

ssdMergeLayer

Create SSD merge layer for object detection

Description

An SSD merge layer merges the outputs of feature maps for subsequent regression and classification loss computation. Use the merged feature maps to compute focal loss for classification and smooth L1 loss for regression.

Creation

Syntax

```
layer = ssdMergeLayer(NumChannels,NumInputs)
layer = ssdMergeLayer(NumChannels,NumInputs, 'Name', Name)
```

Description

`layer = ssdMergeLayer(NumChannels,NumInputs)` creates an SSD merge layer, specifying the `NumChannels` and `NumInputs` properties as the number of feature map channels and number of inputs to merge, respectively.

`layer = ssdMergeLayer(NumChannels,NumInputs, 'Name', Name)` creates an SSD merge layer and sets the optional `Name` property using a name-value pair. Enclose the property name in single quotes.

For example, `ssdMergeLayer(4,6, 'Name', 'sm1')` creates an SSD merge layer with the name 'sm1' that merges four dimensions and six feature maps.

Properties

NumChannels — Number of feature map channels

positive integer

Number of feature map channels per anchor box, specified as a positive integer. For regression problems, `NumChannels` is 4 (for x, y, w, and h). For classification problems, `NumChannels` equals the number of classes that are being detected plus one for the background class.

NumInputs — Number of inputs to merge

positive integer

Number of inputs to merge, specified as a positive integer.

Name — Layer name

' ' (default) | character vector | string scalar

Layer name, specified as a character vector or a string scalar. For `Layer` array input, the `trainNetwork`, `assembleNetwork`, `layerGraph`, and `dlnetwork` functions automatically assign names to layers with `Name` set to `''`.

Data Types: `char` | `string`

Examples

Create SSD Merge Layer for Regression

Specify the number of feature map channels per anchor box. Regression merges four channels.

```
numChannels = 4;
```

Specify the number of inputs to merge.

```
numInputs = 6;
```

Create an SSD merge layer named `regressionMergeLayer`.

```
layer = ssdMergeLayer(numChannels,numInputs,'Name','regressionMergeLayer')
```

```
layer =  
  SSDMergeLayer with properties:  
      Name: 'regressionMergeLayer'  
  NumChannels: 4  
  NumInputs: 6
```

Setup SSD Merge Layer For Classification

Specify the number of classes, e.g. person and vehicle.

```
numClasses = 2
```

```
numClasses = 2
```

Specify the number of inputs.

```
numInputs = 6
```

```
numInputs = 6
```

Create an SSD merge layer for classification. The number of channels equals the number of classes + 1 for the background class.

```
numChannels = numClasses + 1;  
clsMergeLayer = ssdMergeLayer(numChannels, numInputs,'Name','clsMergeLayer')
```

```
clsMergeLayer =  
  SSDMergeLayer with properties:  
      Name: 'clsMergeLayer'
```

```
NumChannels: 3  
NumInputs: 6
```

Extended Capabilities

GPU Code Generation

Generate CUDA® code for NVIDIA® GPUs using GPU Coder™.

To generate CUDA or C++ code by using GPU Coder, you must first construct and train a deep neural network. Once the network is trained and evaluated, you can configure the code generator to generate code and deploy the convolutional neural network on platforms that use NVIDIA or ARM GPU processors. For more information, see “Deep Learning with GPU Coder” (GPU Coder).

For this layer, you can generate code that takes advantage of the NVIDIA CUDA deep neural network library (cuDNN), or the NVIDIA TensorRT high performance inference library.

See Also

`trainNetwork` | `trainSSDObjectDetector`

Topics

“Getting Started with Object Detection Using Deep Learning”

“Getting Started with SSD Multibox Detection”

“List of Deep Learning Layers” (Deep Learning Toolbox)

“Deep Learning in MATLAB” (Deep Learning Toolbox)

“Specify Layers of Convolutional Neural Network” (Deep Learning Toolbox)

Introduced in R2020a

yolov2OutputLayer

Create output layer for YOLO v2 object detection network

Description

The `yolov2OutputLayer` function creates a `YOLOv2OutputLayer` object, which represents the output layer for you only look once version 2 (YOLO v2) object detection network. The output layer provides the refined bounding box locations of the target objects.

Creation

Syntax

```
layer = yolov2OutputLayer(anchorBoxes)
layer = yolov2OutputLayer(anchorBoxes, Name, Value)
```

Description

`layer = yolov2OutputLayer(anchorBoxes)` creates a `YOLOv2OutputLayer` object, `layer`, which represents the output layer for YOLO v2 object detection network. The layer outputs the refined bounding box locations that are predicted using a predefined set of anchor boxes specified at the input.

`layer = yolov2OutputLayer(anchorBoxes, Name, Value)` sets the additional properties using name-value pairs and the input from the preceding syntax. Enclose each property name in single quotes. For example, `yolov2OutputLayer('Name', 'yolo_Out')` creates an output layer with the name 'yolo_Out'.

Input Arguments

anchorBoxes — Set of anchor boxes

M-by-2 matrix

Set of anchor boxes, specified as an *M*-by-2 matrix, where each row is of the form [*height width*]. The matrix defines the height and the width of *M* number of anchor boxes. This input sets the `AnchorBoxes` property of the output layer. You can use the clustering approach for estimating anchor boxes from the training data. For more information, see “Estimate Anchor Boxes From Training Data”.

Data Types: `single` | `double` | `int8` | `int16` | `int32` | `int64` | `uint8` | `uint16` | `uint32` | `uint64`

Properties

Name — Layer name

`''` (default) | character vector | string scalar

Layer name, specified as a character vector or a string scalar. For Layer array input, the `trainNetwork`, `assembleNetwork`, `layerGraph`, and `dlnetwork` functions automatically assign names to layers with `Name` set to ''.

Data Types: `char` | `string`

LossFunction — Loss function

'mean-squared-error' (default)

This property is read-only.

Loss function, set as 'mean-squared-error'. For more information about the loss function, see “Loss Function for Bounding Box Refinement” on page 2-299.

AnchorBoxes — Set of anchor boxes

M-by-2 matrix

This property is read-only.

Set of anchor boxes used for training, specified as a *M*-by-2 matrix defining the width and the height of *M* number of anchor boxes. This property is set by the input `anchorBoxes`.

Data Types: `single` | `double` | `int8` | `int16` | `int32` | `int64` | `uint8` | `uint16` | `uint32` | `uint64`

LossFactors — Weights in the loss function

[5 1 1 1] (default) | 1-by-4 vector

This property is read-only.

Weights in the loss function, specified as a 1-by-4 vector of form $[K_1 K_2 K_3 K_4]$. Weights increase the stability of the network model by penalizing incorrect bounding box predictions and false classifications. For more information about the weights in loss the function, see “Loss Function for Bounding Box Refinement” on page 2-299.

Data Types: `single` | `double` | `int8` | `int16` | `int32` | `int64` | `uint8` | `uint16` | `uint32` | `uint64`

Classes — Classes of the output layer

'auto' (default) | categorical vector | string array | cell array of character vectors

Classes of the output layer, specified as a categorical vector, string array, cell array of character vectors, or 'auto'. Use this name-value pair to specify the names of the object classes in the input training data.

If the value is set to 'auto', then the software automatically sets the classes at training time. If you specify the string array or cell array of character vectors `str`, then the software sets the classes of the output layer to `categorical(str)`. The default value is 'auto'.

Data Types: `char` | `string` | `cell` | `categorical`

NumInputs — Number of inputs

1 (default)

This property is read-only.

Number of inputs of the layer. This layer accepts a single input only.

Data Types: `double`

InputNames — Input names`{'in'} (default)`

This property is read-only.

Input names of the layer. This layer accepts a single input only.

Data Types: `cell`

Examples**Create YOLO v2 Output Layer**

Create a YOLO v2 output layer with two anchor boxes.

Define the height and the width of the anchor boxes.

```
anchorBoxes = [16 16;32 32];
```

Specify the names of the object classes in the training data.

```
classNames = {'Vehicle','Person'};
```

Generate a YOLO v2 output layer with the name "yolo_Out".

```
layer = yolov2OutputLayer(anchorBoxes,'Name','yolo_Out','Classes',classNames);
```

Inspect the properties of the YOLO v2 output layer.

```
layer
```

```
layer =  
  YOLOv2OutputLayer with properties:  
      Name: 'yolo_Out'  
  
  Hyperparameters  
      Classes: [2x1 categorical]  
      LossFunction: 'mean-squared-error'  
      AnchorBoxes: [2x2 double]  
      LossFactors: [5 1 1 1]
```

You can read the values for `Classes` property by using dot notation `layer.Classes`. The function stores the class names as a categorical array.

```
layer.Classes
```

```
ans = 2x1 categorical  
  Vehicle  
  Person
```

More About

Loss Function for Bounding Box Refinement

During training, the output layer of YOLO v2 network predicts refined bounding box locations by optimizing the mean squared error loss between predicted bounding boxes and the ground truth. The loss function is defined as

$$\begin{aligned}
 & K_1 \sum_{i=0}^{S^2} \sum_{j=0}^B 1_{ij}^{obj} [(x_i - \hat{x}_i)^2 + (y_i - \hat{y}_i)^2] \\
 & + K_1 \sum_{i=0}^{S^2} \sum_{j=0}^B 1_{ij}^{obj} [(\sqrt{w_i} - \sqrt{\hat{w}_i})^2 + (\sqrt{h_i} - \sqrt{\hat{h}_i})^2] \\
 & + K_2 \sum_{i=0}^{S^2} \sum_{j=0}^B 1_{ij}^{obj} (C_i - \hat{C}_i)^2 \\
 & + K_3 \sum_{i=0}^{S^2} \sum_{j=0}^B 1_{ij}^{noobj} (C_i - \hat{C}_i)^2 \\
 & + K_4 \sum_{i=0}^{S^2} 1_i^{obj} \sum_{c \in \text{classes}} (p_i(c) - \hat{p}_i(c))^2
 \end{aligned}$$

where:

- S is the number of grid cells
- B is the number of bounding boxes in each grid cell.
- 1_{ij}^{obj} is 1 if the j th bounding box in grid cell i is responsible for detecting the object. Otherwise it is set to 0. A grid cell i is responsible for detecting the object, if the overlap between the ground truth and a bounding box in that grid cell is greater than or equal to 0.6.
- 1_{ij}^{noobj} is 1 if the j th bounding box in grid cell i does not contain any object. Otherwise it is set to 0.
- 1_i^{obj} is 1 if an object is detected in grid cell i . Otherwise it is set to 0.
- $K_1, K_2, K_3,$ and K_4 are the weights. To adjust the weights, modify the `LossFactors` property.

The loss function can be split into three parts:

- Localization loss

The first and second terms in the loss function comprise the localization loss. It measures error between the predicted bounding box and the ground truth. The parameters for computing the localization loss include the position, size of the predicted bounding box, and the ground truth. The parameters are defined as follows.

- (x_i, y_i) , is the center of the j th bounding box relative to grid cell i .
- (\hat{x}_i, \hat{y}_i) , is the center of the ground truth relative to grid cell i .
- w_i and h_i is the width and the height of the j th bounding box in grid cell i , respectively. The size of the predicted bounding box is specified relative to the input image size.

- \widehat{w}_i and \widehat{h}_i is the width and the height of the ground truth in grid cell i , respectively.
- K_1 is the weight for localization loss. Increase this value to increase the weightage for bounding box prediction errors.
- Confidence loss

The third and fourth terms in the loss function comprise the confidence loss. The third term measures the objectness (confidence score) error when an object is detected in the j th bounding box of grid cell i . The fourth term measures the objectness error when no object is detected in the j th bounding box of grid cell i . The parameters for computing the confidence loss are defined as follows.

- C_i is the confidence score of the j th bounding box in grid cell i .
- \hat{C}_i is the confidence score of the ground truth in grid cell i .
- K_2 is the weight for objectness error, when an object is detected in the predicted bounding box. You can adjust the value of K_2 to weigh confidence scores from grid cells that contain objects.
- K_3 is the weight for objectness error, when an object is not detected in the predicted bounding box. You can adjust the value of K_3 to weigh confidence scores from grid cells that do not contain objects.

The confidence loss can cause the training to diverge when the number of grid cells that do not contain objects is more than the number of grid cells that contain objects. To remedy this, increase the value for K_2 and decrease the value for K_3 .

- Classification loss

The fifth term in the loss function comprises the classification loss. For example, suppose that an object is detected in the predicted bounding box contained in grid cell i . Then, the classification loss measures the squared error between the class conditional probabilities for each class in grid cell i . The parameters for computing the classification loss are defined as follows.

- $p_i(c)$ is the estimated conditional class probability for object class c in grid cell i .
- $\hat{p}_i(c)$ is the actual conditional class probability for object class c in grid cell i .
- K_4 is the weight for classification error when an object is detected in the grid cell. Increase this value to increase the weightage for classification loss.

Tips

To improve prediction accuracy, you can:

- Train the network with more number of images. You can expand the training dataset through data augmentation. For information on how to apply data augmentation for training dataset, see “Preprocess Images for Deep Learning” (Deep Learning Toolbox).
- Perform multiscale training by using the `trainYOLOv2ObjectDetector` function. To do so, specify the 'TrainingImageSize' argument of `trainYOLOv2ObjectDetector` function for training the network.
- Choose anchor boxes appropriate to the dataset for training the network. You can use the `estimateAnchorBoxes` function to compute anchor boxes directly from the training data.

References

- [1] Joseph. R, S. K. Divvala, R. B. Girshick, and F. Ali. "You Only Look Once: Unified, Real-Time Object Detection." In *Proceedings of the IEEE Conference on Computer Vision and Pattern Recognition (CVPR)*, pp. 779–788. Las Vegas, NV: CVPR, 2016.
- [2] Joseph. R and F. Ali. "YOLO 9000: Better, Faster, Stronger." In *Proceedings of the IEEE Conference on Computer Vision and Pattern Recognition (CVPR)*, pp. 6517–6525. Honolulu, HI: CVPR, 2017.

Extended Capabilities

GPU Code Generation

Generate CUDA® code for NVIDIA® GPUs using GPU Coder™.

To generate CUDA or C++ code by using GPU Coder, you must first construct and train a deep neural network. Once the network is trained and evaluated, you can configure the code generator to generate code and deploy the convolutional neural network on platforms that use NVIDIA or ARM GPU processors. For more information, see “Deep Learning with GPU Coder” (GPU Coder).

For this layer, you can generate code that takes advantage of the NVIDIA CUDA deep neural network library (cuDNN), NVIDIA TensorRT high performance inference library, or the ARM Compute Library for Mali GPU.

See Also

[yolov2Layers](#) | [spaceToDepthLayer](#) | [yolov2ObjectDetector](#) | [trainYOLOv2ObjectDetector](#)

Topics

“Create YOLO v2 Object Detection Network”
“Object Detection Using YOLO v2 Deep Learning”
“Estimate Anchor Boxes From Training Data”
“Code Generation for Object Detection by Using YOLO v2”
“Getting Started with YOLO v2”
“Anchor Boxes for Object Detection”

Introduced in R2019a

yolov2ReorgLayer

(Not recommended) Create reorganization layer for YOLO v2 object detection network

Note function is not recommended. Use `spaceToDepthLayer` instead.

Description

The `yolov2ReorgLayer` function creates a `YOLOv2ReorgLayer` object, which represents the reorganization layer for you only look once version 2 (YOLO v2) object detection network. The reorganization layer reorganizes the high-resolution feature maps from a lower layer by stacking adjacent features into different channels. The output of reorganization layer is fed to the depth concatenation layer. The depth concatenation layer concatenates the reorganized high-resolution features with the low-resolution features from a higher layer.

Creation

Syntax

```
layer = yolov2ReorgLayer(stride)
layer = yolov2ReorgLayer(stride, 'Name', layerName)
```

Description

`layer = yolov2ReorgLayer(stride)` creates the reorganization layer for YOLO v2 object detection network. The layer reorganizes the dimension of the input feature maps according to the step size specified in `stride`. For details on creating a YOLO v2 network with reorganization layer, see “Design a YOLO v2 Detection Network with a Reorg Layer”.

`layer = yolov2ReorgLayer(stride, 'Name', layerName)` sets the `Name` property using a name-value pair. Enclose the property name in single quotes. For example, `yolov2ReorgLayer('Name', 'yolo_Reorg')` creates reorganization layer with the name 'yolo_Reorg'.

Input Arguments

stride — Step size for traversing input

vector of two positive integers

Step size for traversing the input vertically and horizontally, specified as a 2-element vector of positive integers in form `[a b]`. `a` is the vertical step size and `b` is the horizontal step size.

Data Types: `single` | `double` | `int8` | `int16` | `int32` | `int64` | `uint8` | `uint16` | `uint32` | `uint64`

layerName — Name of reorganization layer

character vector | string scalar

Name of reorganization layer, specified as a character vector or string scalar. This input argument sets the Name property of the layer. If you do not specify the name, then the function automatically sets Name to ''.

Data Types: char | string

Properties

Name — Layer name

'' (default) | character vector

Layer name, specified as a character vector. To include a layer in a layer graph, you must specify a nonempty unique layer name. If you train a series network with the layer and Name is set to '', then the software automatically assigns a name to the layer at training time.

Data Types: char

NumInputs — Number of inputs

1 (default)

This property is read-only.

Number of inputs of the layer. This layer accepts a single input only.

Data Types: double

InputNames — Input names

{'in'} (default)

This property is read-only.

Input names of the layer. This layer accepts a single input only.

Data Types: cell

NumOutputs — Number of outputs

1 (default)

This property is read-only.

Number of outputs of the layer. This layer has a single output only.

Data Types: double

OutputNames — Output names

{'out'} (default)

This property is read-only.

Output names of the layer. This layer has a single output only.

Data Types: cell

Examples

Create YOLO v2 Reorganization Layer

Specify the step size for reorganising the dimension of input feature map.

```
stride = [2 2];
```

Create a YOLO v2 reorganization layer with the specified step size and the name as "yolo_Reorg".

```
layer = yolov2ReorgLayer(stride, 'Name', 'yolo_Reorg');
```

Inspect the properties of the YOLO v2 reorganization layer.

```
layer
```

```
layer =  
  YOLOv2ReorgLayer with properties:  
    Name: 'yolo_Reorg'  
    Hyperparameters  
      Stride: [2 2]
```

Tips

- You can find the desired value of `stride` using:

$$stride = \text{floor}\left(\frac{\text{size of input feature map to reorganization layer}}{\text{size of output feature map from higher layer}}\right)$$

Algorithms

The reorganization layer improves the performance of the YOLO v2 object detection network by facilitating feature concatenation from different layers. It reorganizes the dimension of a lower layer feature map so that it can be concatenated with the higher layer feature map.

Consider an input feature map of size $[H W C]$, where:

- H is the height of the feature map.
- W is the width of the feature map.
- C is the number of channels.

The reorganization layer chooses feature map values from locations based on the step sizes in `stride` and adds those feature values to the third dimension C . The size of the reorganized feature map from the reorganization layer is

$$[\text{floor}(H/\text{stride}(1)) \text{ floor}(W/\text{stride}(2)) C \times \text{stride}(1) \times \text{stride}(2)].$$

For feature concatenation, the height and width of the reorganized feature map must match with the height and width of the higher layer feature map.

Compatibility Considerations

yolov2ReorgLayer function will be removed

Not recommended starting in R2020b

The YOLOv2ReorgLayer function will be removed in a future release. Use spaceToDepthLayer instead.

References

- [1] Joseph. R, S. K. Divvala, R. B. Girshick, and F. Ali. "You Only Look Once: Unified, Real-Time Object Detection." In *Proceedings of the IEEE Conference on Computer Vision and Pattern Recognition (CVPR)*, pp. 779–788. Las Vegas, NV: CVPR, 2016.
- [2] Joseph. R and F. Ali. "YOLO 9000: Better, Faster, Stronger." In *Proceedings of the IEEE Conference on Computer Vision and Pattern Recognition (CVPR)*, pp. 6517–6525. Honolulu, HI: CVPR, 2017.

Extended Capabilities

GPU Code Generation

Generate CUDA® code for NVIDIA® GPUs using GPU Coder™.

To generate CUDA or C++ code by using GPU Coder, you must first construct and train a deep neural network. Once the network is trained and evaluated, you can configure the code generator to generate code and deploy the convolutional neural network on platforms that use NVIDIA or ARM GPU processors. For more information, see “Deep Learning with GPU Coder” (GPU Coder).

For this layer, you can generate code that takes advantage of the NVIDIA CUDA deep neural network library (cuDNN), NVIDIA TensorRT high performance inference library, or the ARM Compute Library for Mali GPU.

GPU Arrays

Accelerate code by running on a graphics processing unit (GPU) using Parallel Computing Toolbox™.

This function fully supports GPU arrays. For more information, see “Run MATLAB Functions on a GPU” (Parallel Computing Toolbox).

See Also

yolov2Layers | yolov2OutputLayer | yolov2TransformLayer | yolov2ObjectDetector | trainYOLOv2ObjectDetector

Topics

- “Create YOLO v2 Object Detection Network”
- “Object Detection Using YOLO v2 Deep Learning”
- “Estimate Anchor Boxes From Training Data”
- “Code Generation for Object Detection by Using YOLO v2”
- “Getting Started with YOLO v2”
- “Anchor Boxes for Object Detection”

Introduced in R2019a

yolov2TransformLayer

Create transform layer for YOLO v2 object detection network

Description

The `yolov2TransformLayer` function creates a `YOLOv2TransformLayer` object, which represents the transform layer for you only look once version 2 (YOLO v2) object detection network. The transform layer in YOLO v2 object detection network improves the stability of the network by constraining the location predictions. The transform layer extracts activations of the last convolutional layer and transforms the bounding box predictions to fall within the bounds of the ground truth.

Creation

Syntax

```
layer = yolov2TransformLayer(numAnchorBoxes)
layer = yolov2TransformLayer(numAnchorBoxes, Name, Value)
```

Description

`layer = yolov2TransformLayer(numAnchorBoxes)` creates the transform layer for YOLO v2 object detection network.

`layer = yolov2TransformLayer(numAnchorBoxes, Name, Value)` sets the `Name` property using a name-value pair. Enclose the property name in single quotes. For example, `yolov2TransformLayer('Name', 'yolo_Transform')` creates a transform layer with the name 'yolo_Transform'.

Input Arguments

numAnchorBoxes — Number of anchor boxes

positive integer

Number of anchor boxes used for training, specified as a positive integer. This input sets the `NumAnchorBoxes` property of the transform layer.

Data Types: `single` | `double` | `int8` | `int16` | `int32` | `int64` | `uint8` | `uint16` | `uint32` | `uint64`

Properties

Name — Layer name

`''` (default) | character vector | string scalar

Layer name, specified as a character vector or a string scalar. For `Layer` array input, the `trainNetwork`, `assembleNetwork`, `layerGraph`, and `dlnetwork` functions automatically assign names to layers with `Name` set to `''`.

Data Types: char | string

NumAnchorBoxes — Number of anchor boxes

positive integer

This property is read-only.

Number of anchor boxes used for training, specified as a positive integer. This property is set by the input numAnchorBoxes.

NumInputs — Number of inputs

1 (default)

This property is read-only.

Number of inputs of the layer. This layer accepts a single input only.

Data Types: double

InputNames — Input names

{ 'in' } (default)

This property is read-only.

Input names of the layer. This layer accepts a single input only.

Data Types: cell

NumOutputs — Number of outputs

1 (default)

This property is read-only.

Number of outputs of the layer. This layer has a single output only.

Data Types: double

OutputNames — Output names

{ 'out' } (default)

This property is read-only.

Output names of the layer. This layer has a single output only.

Data Types: cell

Examples

Create YOLO v2 Transform Layer

Specify the number of anchor boxes.

```
numAnchorBoxes = 5;
```

Create a YOLO v2 transform layer with the name "yolo_Transform".

```
layer = yolov2TransformLayer(numAnchorBoxes, 'Name', 'yolo_Transform');
```

Inspect the properties of the YOLO v2 transform layer.

```
layer
```

```
layer =  
  YOLOv2TransformLayer with properties:  
  
      Name: 'yolo_Transform'  
  
  Hyperparameters  
    NumAnchorBoxes: 5
```

References

- [1] Joseph. R, S. K. Divvala, R. B. Girshick, and F. Ali. "You Only Look Once: Unified, Real-Time Object Detection." In *Proceedings of the IEEE Conference on Computer Vision and Pattern Recognition (CVPR)*, pp. 779–788. Las Vegas, NV: CVPR, 2016.
- [2] Joseph. R and F. Ali. "YOLO 9000: Better, Faster, Stronger." In *Proceedings of the IEEE Conference on Computer Vision and Pattern Recognition (CVPR)*, pp. 6517–6525. Honolulu, HI: CVPR, 2017.

Extended Capabilities

GPU Code Generation

Generate CUDA® code for NVIDIA® GPUs using GPU Coder™.

To generate CUDA or C++ code by using GPU Coder, you must first construct and train a deep neural network. Once the network is trained and evaluated, you can configure the code generator to generate code and deploy the convolutional neural network on platforms that use NVIDIA or ARM GPU processors. For more information, see “Deep Learning with GPU Coder” (GPU Coder).

For this layer, you can generate code that takes advantage of the NVIDIA CUDA deep neural network library (cuDNN), NVIDIA TensorRT high performance inference library, or the ARM Compute Library for Mali GPU.

GPU Arrays

Accelerate code by running on a graphics processing unit (GPU) using Parallel Computing Toolbox™.

This function fully supports GPU arrays. For more information, see “Run MATLAB Functions on a GPU” (Parallel Computing Toolbox).

See Also

[yolov2Layers](#) | [yolov2OutputLayer](#) | [spaceToDepthLayer](#) | [yolov2ObjectDetector](#) | [trainYOLOv2ObjectDetector](#)

Topics

- “Create YOLO v2 Object Detection Network”
- “Object Detection Using YOLO v2 Deep Learning”
- “Estimate Anchor Boxes From Training Data”
- “Code Generation for Object Detection by Using YOLO v2”

“Getting Started with YOLO v2”
“Anchor Boxes for Object Detection”

Introduced in R2019a

pixelLabelDatastore

Datastore for pixel label data

Description

You can use a `PixelLabelDatastore` object to read pixel label data for semantic segmentation.

To read pixel label data from a `PixelLabelDatastore`, use the `read` function. This function returns a categorical array that contains a categorical label assigned to every (i,j) pixel location or (i,j,k) voxel location.

Creation

Create a `PixelLabelDatastore` object using the `pixelLabelDatastore` function described here. Once the object is created, you can use functions that access and manage the data. You can use dot notation to modify the `ReadSize` and `ReadFcn` properties.

Syntax

```
pxds = pixelLabelDatastore(gTruth)
pxds = pixelLabelDatastore(location,classNames,pixelLabelIDs)
pxds = pixelLabelDatastore(___,Name,Value)
```

Description

`pxds = pixelLabelDatastore(gTruth)` creates a `PixelLabelDatastore` object from a `groundTruth` object or an array of `groundTruth` objects.

`pxds = pixelLabelDatastore(location,classNames,pixelLabelIDs)` creates a `PixelLabelDatastore` object from image files that store pixel label data, in the folder or files specified by `location`. The function creates the object using pixel IDs that map image pixel label values to class names.

`pxds = pixelLabelDatastore(___,Name,Value)` creates a `PixelLabelDatastore` object using name-value pair arguments to set one or both of the `ReadSize` or `AlternateFileSystemRoots` properties. For image file input, you can also use name-value pair arguments to set the `ReadFcn` property or to specify options on page 2-312 about files to include in the datastore. You can specify multiple name-value pairs. Enclose each property name in quotes.

For example,
`pixelLabelDatastore(loc,names,ids,'ReadSize',8,'FileExtensions','png')` creates a pixel label datastore that includes only PNG images and that reads eight images during each call to the `read` function.

Input Arguments

gTruth — Ground truth data

`groundTruth` object | array of `groundTruth` objects

Ground truth data, specified as a `groundTruth` object or as an array of `groundTruth` objects. Each `groundTruth` object contains information about the data source, the list of label definitions, and all marked labels for a set of ground truth labels.

location — Folder or image file names

character vector | cell array of character vectors | string array

Folder or image file names, specified as a character vector, string array, or cell array of character vectors. Images must contain `uint8` data.

location	Description
character vector, string array	Name of a folder. Files within subfolders of the specified folder are not automatically included in the datastore. The datastore includes only images with supported file formats and ignores any other format. See a list of supported file formats by using the <code>imformats</code> function.
cell array of character vectors	File names of multiple images.

`pixelLabelDatastore` expands the file names and stores the full file paths in the `Files` property.

You can use the wildcard character (*) when specifying `location`. This character indicates that all matching files or all files in the matching folders are included in the datastore.

If the files are not in the current folder, then you must include the full or relative path.

If the files are not available locally, then the full path of the files or folders must be an internationalized resource identifier (IRI), such as `hdfs://hostname:portnumber/path_to_file`. For information on using a datastore with Amazon S3™ and HDFS™, see “Work with Remote Data”.

Example: 'file1.jpg'

Example: '../dir/data/file1.png'

Example: {'C:\dir\data\file1.tif', 'C:\dir\data\file2.tif'}

Example: 'C:\dir\data*.jpg'

Data Types: char | cell

classNames — Class names

cell array of character vectors | cell array of strings

Class names, specified as a cell array of strings or character vectors. `pixelLabelDatastore` converts the names to a cell array and stores the names in the `ClassNames` property.

Example: ["sky" "grass" "building" "sidewalk"]

pixelLabelIDs — IDs to relate pixel labels to class names

vector | m -by-3 matrix | cell array of column vectors | cell array of m -by-3 matrices

IDs to map pixel labels to `ClassNames`, specified as a vector, an m -by-3 matrix, a cell array of column vectors, or a cell array of m -by-3 matrices. Values must be integers in the range [0, 255]. m -by-3 matrices are only supported for RGB images.

Format	Description
vector	The length of the vector must equal the number of class names. Values must be unique.
m -by-3 matrix	m corresponds to the number of class names. Each row contains a 3-element vector representing the RGB pixel value to associate with each class name. Vectors must be unique. Use this format for pixel label data stored as RGB images.
cell array of column vectors cell array of m -by-3 matrices	Use a cell array to map multiple pixel label IDs to one class name.

Name-Value Pair Arguments

Specify optional comma-separated pairs of `Name`, `Value` arguments. `Name` is the argument name and `Value` is the corresponding value. `Name` must appear inside quotes. You can specify several name and value pair arguments in any order as `Name1, Value1, ..., NameN, ValueN`.

Example: `'IncludeSubfolders', true`

IncludeSubfolders — Include subfolders

`false` (default) | `true`

Include subfolders, specified as the comma-separated pair consisting of `'IncludeSubfolders'` and `false` (0), or `true` (1). Specify `true` to include all files and subfolders within each folder or `false` to include only the files within each folder.

The `IncludeSubfolders` argument is not supported when you specify ground truth data `gTruth`.

FileExtensions — File extensions

character vector | cell array of character vectors | string scalar | string array

File extensions of files to include in the datastore, specified as the comma-separated pair consisting of `'FileExtensions'` and a character vector, cell array of character vectors, string scalar, or string array. By default, the datastore includes files with all extensions supported by the `imformats` function.

The `FileExtensions` argument is not supported when you specify ground truth data `gTruth`.

Example: `["png" "gif" "bmp"]`

Properties

Files — Files included in datastore

character vector | cell array of character vectors

This property is read-only.

Files included in the datastore, specified as a character vector or cell array of character vectors. Each character vector is a full path to a file. When you create a `PixelLabelDatastore` object, use the `location` argument to set this property.

ClassNames — Class names

cell array of character vectors

This property is read-only.

Class names, specified as a cell array of character vectors.

ReadSize — Maximum number of image files

1 (default) | positive integer

Maximum number of image files to read in each call to the `read` function, specified as a positive integer.

AlternateFileSystemRoots — Alternate file system root paths

string vector | cell array

Alternate file system root paths, specified as the name-value argument consisting of "AlternateFileSystemRoots" and a string vector or a cell array. Use "AlternateFileSystemRoots" when you create a datastore on a local machine, but need to access and process the data on another machine (possibly of a different operating system). Also, when processing data using the Parallel Computing Toolbox and the MATLAB Parallel Server™, and the data is stored on your local machines with a copy of the data available on different platform cloud or cluster machines, you must use "AlternateFileSystemRoots" to associate the root paths.

- To associate a set of root paths that are equivalent to one another, specify "AlternateFileSystemRoots" as a string vector. For example,

```
["Z:\datasets", "/mynetwork/datasets"]
```
- To associate multiple sets of root paths that are equivalent for the datastore, specify "AlternateFileSystemRoots" as a cell array containing multiple rows where each row represents a set of equivalent root paths. Specify each row in the cell array as either a string vector or a cell array of character vectors. For example:

- Specify "AlternateFileSystemRoots" as a cell array of string vectors.

```
{"Z:\datasets", "/mynetwork/datasets"};...
{"Y:\datasets", "/mynetwork2/datasets", "S:\datasets"}}
```

- Alternatively, specify "AlternateFileSystemRoots" as a cell array of cell array of character vectors.

```
{{'Z:\datasets', '/mynetwork/datasets'};...
{'Y:\datasets', '/mynetwork2/datasets', 'S:\datasets'}}
```

The value of "AlternateFileSystemRoots" must satisfy these conditions:

- Contains one or more rows, where each row specifies a set of equivalent root paths.
- Each row specifies multiple root paths and each root path must contain at least two characters.
- Root paths are unique and are not subfolders of one another.
- Contains at least one root path entry that points to the location of the files.

For more information, see "Set Up Datastore for Processing on Different Machines or Clusters".

Example: ["Z:\datasets", "/mynetwork/datasets"]

Data Types: string | cell

ReadFcn — Function that reads pixel labeled image data

@readDatastoreImage (default) | function handle

Function that reads pixel labeled image data, specified as a function handle. The custom read function must take an image file name as input, and then output the corresponding pixel labeled data as a categorical matrix, logical matrix, or numeric matrix of data type `uint8`. For example, if `customreader` is the specified function to read the image data, then it must have a signature similar to the following:

```
function C = customreader(filename)
...
end
```

If the read function has more than one output argument, then only the first one is used. The rest are ignored.

The `ReadFcn` property is not supported when you specify ground truth data `gTruth`.

Example: @customreader

Object Functions

<code>combine</code>	Combine data from multiple datastores
<code>countEachLabel</code>	Count occurrence of pixel or box labels
<code>hasdata</code>	Determine if data is available to read from datastore
<code>numpartitions</code>	Number of partitions for a datastore
<code>partition</code>	Partition a label datastore
<code>preview</code>	Read first row of data in datastore
<code>read</code>	Read data from a datastore
<code>readall</code>	Read all data in datastore
<code>readimage</code>	Read specified pixel label data file
<code>reset</code>	Reset datastore to initial state
<code>shuffle</code>	Return shuffled version of datastore
<code>transform</code>	Transform datastore
<code>subset</code>	Create subset of datastore or file-set
<code>isPartitionable</code>	Determine whether datastore is partitionable
<code>isShuffleable</code>	Determine whether datastore is shuffleable

Examples**Read and Display Pixel Label Data**

Overlay pixel label data on an image.

Set the location of the image and pixel label data.

```
dataDir = fullfile(toolboxdir('vision'),'visiondata');
imDir = fullfile(dataDir,'building');
pxDir = fullfile(dataDir,'buildingPixelLabels');
```

Create an image datastore.

```
imds = imageDatastore(imDir);
```

Create a pixel label datastore.

```
classNames = ["sky" "grass" "building" "sidewalk"];  
pixelLabelID = [1 2 3 4];  
pxds = pixelLabelDatastore(pxDir,classNames,pixelLabelID);
```

Read the image and pixel label data. `read(pxds)` returns a categorical matrix, `C`. The element `C(i,j)` in the matrix is the categorical label assigned to the pixel at the location `l(i,j)`.

```
I = read(imds);  
C = read(pxds);
```

Display the label categories in `C`.

```
categories(C{1})
```

```
ans = 4x1 cell  
    {'sky'    }  
    {'grass'  }  
    {'building'}  
    {'sidewalk'}
```

Overlay and display the pixel label data onto the image.

```
B = labeloverlay(I,C{1});  
figure  
imshow(B)
```



Read and Display 3-D Pixel Label Data

Specify the location of 3-D volume and pixel label data. This data is a labeled 3-D MRI scan of a brain.

```
dataDir = fullfile(toolboxdir('images'),'imdata');  
imDir = fullfile(dataDir,'BrainMRILabeled','images');  
pxDir = fullfile(dataDir,'BrainMRILabeled','labels');
```

Specify a custom ReadFcn. This example specifies a function called `samplePXDSMatReader` (defined at the end of the example) that read 3-D image data from `.MAT` image files.

```
matReader = @samplePXDSMatReader;
```

Create an image datastore.

```
imds = imageDatastore(imDir,'FileExtensions','.mat','ReadFcn',matReader);
```

Create a pixel label datastore.

```

classNames = ["edema", "nonEnhancingTumor", "enhancingTumour"];
pixelLabelID = [1 2 3];
pxds = pixelLabelDatastore(pxDir, classNames, pixelLabelID, 'FileExtensions', '.mat', 'ReadFcn', matRea

```

Read volume and pixel label data. L is a categorical matrix, where $L(i, j, k)$ is the categorical label assigned to $V(i, j, k)$.

```

V = read(imds);
L = read(pxds);

```

Display the label categories.

```

categories(L{1})

```

```

ans = 3x1 cell
      {'edema'           }
      {'nonEnhancingTumor'}
      {'enhancingTumour' }

```

Visualize result using `labelvolshow`.

```

h = labelvolshow(L{1}, V);

```

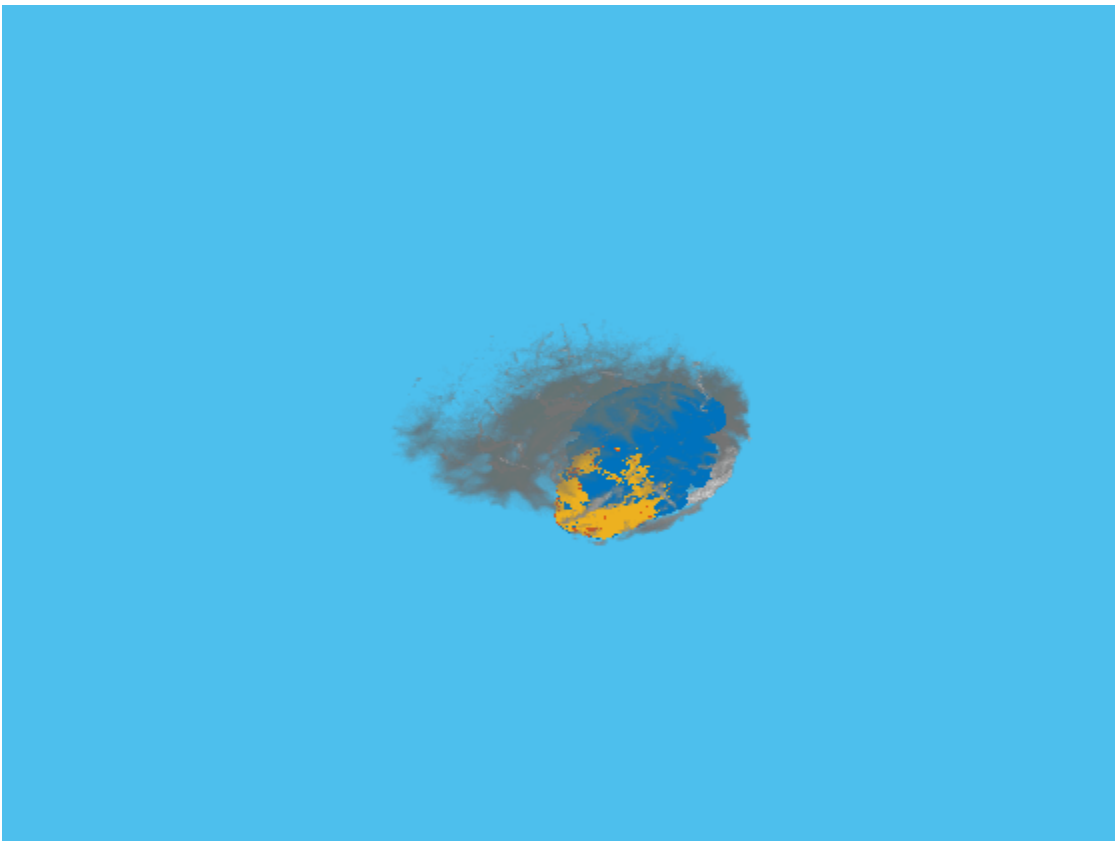

This example defines a helper function, `samplePXDSMatReader`, to read the 3-D image data from the image files. This function loads a .MAT file and returns the first variable saved in that file.

```

function data = samplePXDSMatReader(filename)
    inp = load(filename);

```

```
f = fields(inp);  
data = inp.(f{1});  
end
```

Tips

- A `pixelLabelDatastore` stores files in lexicographical order. For example, if you have twelve files named 'file1.jpg', 'file2.jpg', ..., 'file11.jpg', and 'file12.jpg', then the files are stored in this order:

```
'file1.jpg'  
'file10.jpg'  
'file11.jpg'  
'file12.jpg'  
'file2.jpg'  
'file3.jpg'  
...  
'file9.jpg'
```

In contrast, an `imageDatastore` stores files in the order they are added to the datastore. If you simultaneously read a ground truth image and pixel label data, then you may encounter a mismatch between the images and the labels. If this occurs, then rename the pixel label files so that they have the correct order. For example, rename 'file1.jpg', ..., 'file9.jpg' to 'file01.jpg', ..., 'file09.jpg'.

- To extract semantic segmentation data from a `groundTruth` object generated by the **Video Labeler** app, use the `pixelLabelTrainingData` function.

See Also

Apps

[Image Labeler](#) | [Video Labeler](#)

Functions

[evaluateSemanticSegmentation](#) | [semanticseg](#)

Objects

[ImageDatastore](#) | [groundTruth](#) | [semanticSegmentationMetrics](#) | [pixelLabelImageDatastore](#) | [randomPatchExtractionDatastore](#)

Topics

[“3-D Brain Tumor Segmentation Using Deep Learning”](#)
[“3-D Brain Tumor Segmentation Using Deep Learning”](#)
[“Getting Started with Semantic Segmentation Using Deep Learning”](#)
[“Datastores for Deep Learning” \(Deep Learning Toolbox\)](#)
[“Deep Learning in MATLAB” \(Deep Learning Toolbox\)](#)
[“Training Data for Object Detection and Semantic Segmentation”](#)

Introduced in R2017b

KAZEPoints

Object for storing KAZE interest points

Description

This object provides the ability to pass data between the `detectKAZEFeatures` and `extractFeatures` functions. You can also use this object to manipulate and plot the data returned by these functions. Use the object to fill points interactively, where you might want to mix a non-KAZE interest point detector with a KAZE descriptor.

Creation

Syntax

```
points = KAZEPoints(location)
points = KAZEPoints(location,Name,Value)
```

Description

`points = KAZEPoints(location)` constructs a `KAZEPoints` object from an M -by-2 array $[x\ y]$ of location coordinates.

The scalar `KAZEPoints` object contains many points. Therefore `numel(KAZEPoints)` always returns 1. This value can be different than the result of `length(KAZEPoints)`, which returns the true number of points contained in the object.

`points = KAZEPoints(location,Name,Value)` sets properties using one or more name-value pairs. Enclose each property name in quotes. For example, `points = KAZEPoints('Metric',0.0)`

Input Arguments

location — Location coordinates

M -by-2 array

Location of points, specified as an M -by-2 array of $[x\ y]$ coordinates.

Properties

Location — Location of keypoints

`[]` (default) | M -by-2 matrix

This property is read-only.

Location of keypoints, specified as an M -by-2 matrix. Each row is of the form $[x\ y]$ and represents the location of a keypoint. M is the number of keypoints. You cannot set this property, use the `location` input argument instead.

Count — Number of keypoints

0 (default) | nonnegative integer

This property is read-only.

Number of keypoints held by the object, specified as a nonnegative integer.

Scale — Scale

1.6 (default) | scalar | vector

Scale, specified as a scalar. The scale sets the size at which the interest points are detected.

Metric — Strength of response

0.0 (default) | numeric value | vector

Strength of response for the detected points, specified as a numeric value. The KAZE algorithm uses a determinant of an approximated Hessian.

Orientation — Orientation

0.0 (default) | radians

Orientation of the detected feature, specified as an angle in radians. The angle is measured from the x-axis with the origin set by the `location` input. The `extractFeatures` function sets this property. Do not set it manually.

Object Functions

<code>isempty</code>	Determine if points object is empty
<code>length</code>	Number of stored points
<code>plot</code>	Plot points
<code>selectStrongest</code>	Select points with strongest metrics
<code>size</code>	Return size of points object
<code>selectUniform</code>	Select uniformly distributed subset of feature points

Examples**Detect KAZE Features**

Detect KAZE features and display 10 strongest points.

Read an image.

```
I = imread('cameraman.tif');
```

Detect KAZE features in the image.

```
points = detectKAZEFeatures(I);
```

Select the 10 strongest points.

```
strongest = selectStrongest(points,10);
```

Display the selected points.

```
imshow(I);
hold on;
```

Display the location and scale. The size of the circles displayed relate to the scale.

```
plot(strongest);
hold on;
```



Display the [x y] coordinates for the strongest points in the MATLAB Command Window.

```
strongest.Location
```

```
ans = 10x2 single matrix
```

```
138.5041    95.8063
139.9253    95.8802
111.8975    48.2950
106.4036   174.1800
 44.3964   106.4899
122.0368    65.9064
116.2702   138.2877
123.6542    64.7193
104.2719    76.5821
140.6228    97.9271
```

Detect KAZE Features and Display Specific Points

Detect KAZE features and display set the specific KAZE points you want to plot.

Read an image.

```
I = imread('cameraman.tif');
```

Detect KAZE features in the image.

```
points = detectKAZEFeatures(I);
```

Select and display the last 5 points detected.

```
imshow(I);  
hold on;  
plot(points(end-4:end));  
hold off;
```



Extended Capabilities

C/C++ Code Generation

Generate C and C++ code using MATLAB® Coder™.

Usage notes and limitations:

- To index locations with this object, use the syntax: `points.Location(idx, :)`, for `points` object. See `visionRecoverFromCodeGeneration_kernel.m`, which is used in the “Introduction to Code Generation with Feature Matching and Registration” example.

See Also

`detectKAZEFeatures` | `detectBRISKFeatures` | `detectMSERFeatures` | `detectFASTFeatures` | `detectMinEigenFeatures` | `detectHarrisFeatures` | `extractFeatures` | `matchFeatures` | `detectSURFFeatures` | `MSERRegions` | `SURFPoints` | `cornerPoints` | `BRISKPoints`

Introduced in R2017b

binaryFeatures

Object for storing binary feature vectors

Description

This object provides the ability to pass data between the `extractFeatures` and `matchFeatures` functions. It can also be used to manipulate and plot the data returned by `extractFeatures`.

Creation

Syntax

```
features= binaryFeatures(featureVectors)
```

Description

`features= binaryFeatures(featureVectors)` constructs a `binaryFeatures` object from the M -by- N input matrix, `featureVectors`. This matrix contains M feature vectors stored in N `uint8` containers.

Input Arguments

featureVectors — Input feature vectors

M-by-*N* matrix

Input feature vectors, specified as an M -by- N input matrix. This matrix contains M binary feature vectors stored in N `uint8` containers.

Read-only Properties

Features — Feature vectors

M-by-*N* matrix

Input feature vectors, saved as an M -by- N input matrix. This matrix contains M binary feature vectors stored in N `uint8` containers.

NumBits — Number of bits per feature

integer

Number of bits per feature, saved as an integer. `NumBits` equals the number of `uint8` feature vector containers times 8.

NumFeatures — Number of feature vectors

integer

Number of feature vectors contained in the `binaryFeatures` object, saved as a positive integer.

Examples

Match Two Sets of Binary Feature Vectors

Input feature vectors.

```
features1 = binaryFeatures(uint8([1 8 7 2; 8 1 7 2]));  
features2 = binaryFeatures(uint8([8 1 7 2; 1 8 7 2]));
```

Match the vectors using the Hamming distance.

```
[indexPairs matchMetric] = matchFeatures(features1, features2)
```

indexPairs = 2x2 uint32 matrix

```
1 2  
2 1
```

matchMetric = 2x1 single column vector

```
0  
0
```

Extended Capabilities

C/C++ Code Generation

Generate C and C++ code using MATLAB® Coder™.

See Also

[extractFeatures](#) | [extractHOGFeatures](#) | [matchFeatures](#)

Introduced in R2013a

cameraIntrinsics

Object for storing intrinsic camera parameters

Description

Store information about a camera's intrinsic calibration parameters, including the lens distortion parameters.

Creation

Syntax

```
intrinsics = cameraIntrinsics(focalLength,principalPoint,imageSize)
intrinsics = cameraIntrinsics( ____,Name,Value)
```

Description

`intrinsics = cameraIntrinsics(focalLength,principalPoint,imageSize)` returns a camera intrinsics object that contains the focal length specified as $[fx,fy]$, and the camera's principal point specified as $[cx,cy]$. See `cameraParameters` for more details.

`intrinsics = cameraIntrinsics(____,Name,Value)` uses additional options specified by one or name-value pairs. Enclose each property name in quotes. For example, `intrinsics = cameraIntrinsics('RadialDistortion',[0,0])`

Input Arguments

focalLength — Camera focal length

two-element vector

Camera focal length, specified as a two-element vector, $[fx,fy]$.

$$f_x = F \times sx$$

$$f_y = F \times sy$$

- F is the focal length in world units, typically millimeters
- $[sx, sy]$ are the number of pixels per world unit in the x and y direction respectively
- fx and fy are in pixels

principalPoint — Optical center of camera

two-element vector

Optical center of camera, specified as a two-element vector, $[cx,cy]$, in pixels.

imageSize — Image size produced by the camera

two-element vector

Image size produced by the camera, specified as a two-element vector, $[mrows,ncols]$.

Properties

RadialDistortion — Radial lens distortion

$[0,0]$ (default) | two-element vector | three-element vector

Radial lens distortion, specified as the comma-separated pair consisting of `RadialDistortion` and a two-element vector, $[k1,k2]$, or a three-element vector, $[k1,k2,k3]$. $k1,k2$, and $k3$ are radial distortion coefficients. Radial distortion occurs when light rays bend more near the edges of a lens than they do at its optical center. The smaller the lens, the greater the distortion.

Radial distortion occurs when light rays bend more near the edges of a lens than they do at its optical center. The smaller the lens, the greater the distortion.

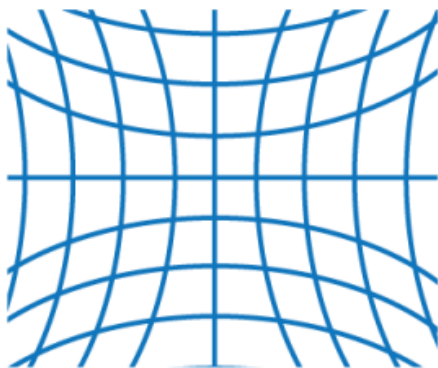

negative radial distortion
"pincushion"

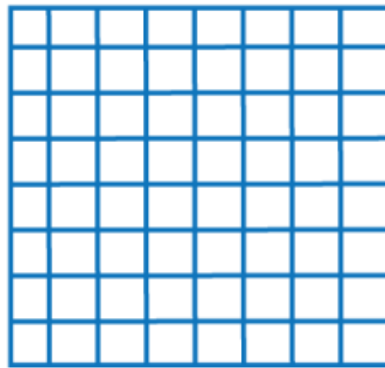

no distortion



positive radial distortion
"barrel"

The `cameraParameters` object calculates the radial distorted location of a point. You can denote the distorted points as $(x_{\text{distorted}}, y_{\text{distorted}})$, as follows:

$$x_{\text{distorted}} = x(1 + k_1*r^2 + k_2*r^4 + k_3*r^6) \quad (2-1)$$

$$y_{\text{distorted}} = y(1 + k_1*r^2 + k_2*r^4 + k_3*r^6) \quad (2-2)$$

x, y = undistorted pixel locations

k_1, k_2 , and k_3 = radial distortion coefficients of the lens

$$r^2 = x^2 + y^2$$

Typically, two coefficients are sufficient. For severe distortion, you can include k_3 . The undistorted pixel locations appear in normalized image coordinates, with the origin at the optical center. The coordinates are expressed in world units.

TangentialDistortion — Tangential distortion coefficients

$[0,0]$ (default) | two-element vector

Tangential distortion coefficients, specified as the comma-separated pair consisting of 'TangentialDistortion' and a 2-element vector, $[p_1,p_2]$. Tangential distortion occurs when the lens and the image plane are not parallel.

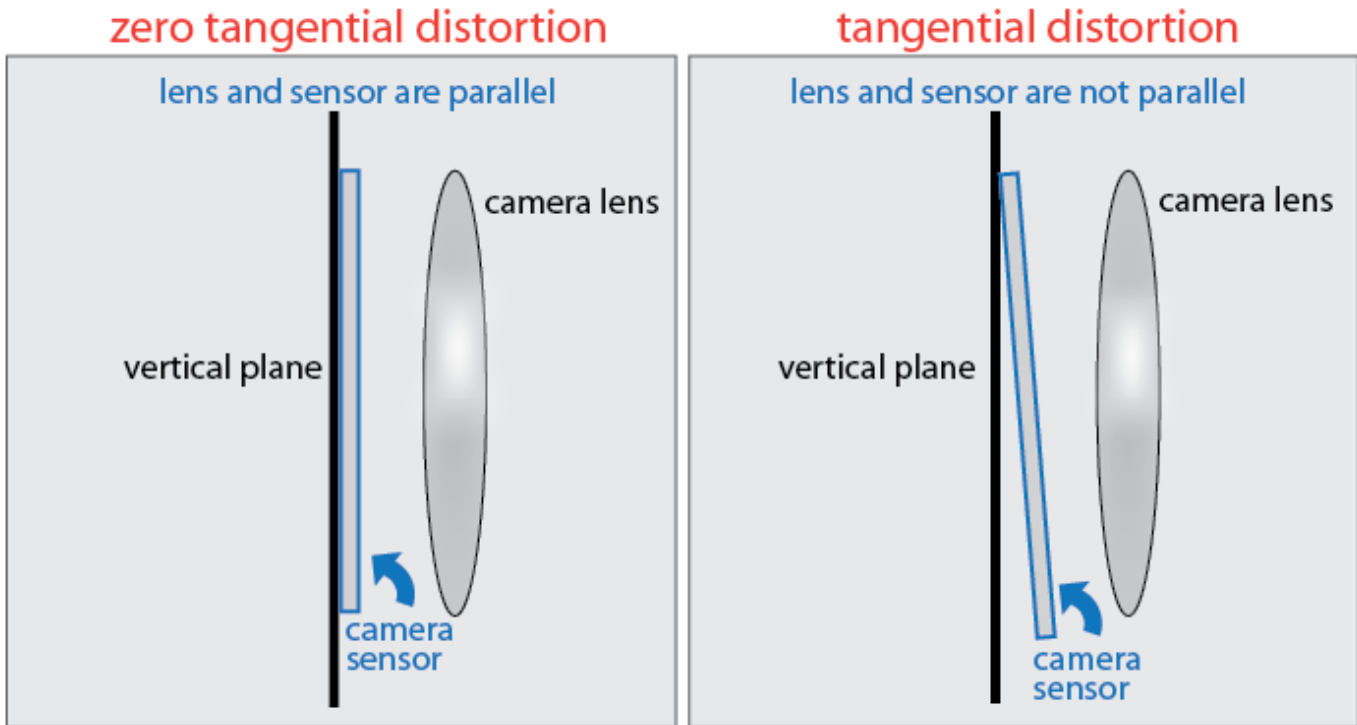

The camera parameters object calculates the tangential distorted location of a point. You can denote the distorted points as $(x_{\text{distorted}}, y_{\text{distorted}})$, as follows:

$$x_{\text{distorted}} = x + [2 * p_1 * x * y + p_2 * (r^2 + 2 * x^2)] \quad (2-3)$$

$$y_{\text{distorted}} = y + [p_1 * (r^2 + 2 * y^2) + 2 * p_2 * x * y] \quad (2-4)$$

x, y = undistorted pixel locations

p_1 and p_2 = tangential distortion coefficients of the lens

$$r^2 = x^2 + y^2$$

The undistorted pixel locations appear in normalized image coordinates, with the origin at the optical center. The coordinates are expressed in world units.

Skew — Camera axes skew

0 (default) | angle

Camera axes skew, specified as the comma-separated pair consisting of 'skew' and an angle. If the x and the y axes are exactly perpendicular, then the skew must be 0.

FocalLength — Focal length

2-element vector

This property is read-only.

Focal length in x and y , stored as a 2-element vector $[fx, fy]$ in pixels.

$$fx = F * sx$$

$$fy = F * sy$$

F is the focal length in world units, typically in millimeters, and $[sx, sy]$ are the number of pixels per world unit in the x and y direction respectively. Thus, fx and fy are in pixels.

The focal length F influences the angle of view and thus affects the area of the scene that appears focused in an image. For a fixed subject distance:

- A short focal length offers a wide angle of view allowing to capture large area of the scene under focus. It emphasizes both the subject and the scene background.
- A long focal length offers a narrow angle of view, thus reducing the area of the scene under focus. It emphasizes more on the subject and restricts the amount of background from being captured.

PrincipalPoint — Optical center of camera

two-element vector

This property is read-only.

Optical center of camera, stored as a two-element vector $[c_x, c_y]$ in pixels. The vector contains the coordinates of the optical center of the camera.

ImageSize — Image size produced by the camera

two-element vector

This property is read-only.

Image size produced by the camera, stored as a two-element vector, $[mrows, ncols]$.

IntrinsicMatrix — Projection matrix

3-by-3 identity matrix (default) | 3-by-3 intrinsic matrix

This property is read-only.

Projection matrix, stored as the comma-separated pair consisting of 'IntrinsicMatrix' and a 3-by-3 matrix. For the matrix format, the object uses the following format:

$$\begin{bmatrix} f_x & 0 & 0 \\ s & f_y & 0 \\ c_x & c_y & 1 \end{bmatrix}$$

The coordinates $[c_x, c_y]$ represent the optical center (the principal point), in pixels. When the x and y axis are exactly perpendicular, the skew parameter, s , equals θ .

$$f_x = F * s_x$$

$$f_y = F * s_y$$

F , is the focal length in world units, typically expressed in millimeters.

$[s_x, s_y]$ are the number of pixels per world unit in the x and y direction respectively.

f_x and f_y are expressed in pixels.

Examples

Create an Object Containing Fundamental Camera Parameters

Define camera parameters without lens distortion or skew.

Specify the focal length and principal point in pixels.

```
focalLength = [800, 800];  
principalPoint = [320, 240];  
imageSize = [480, 640];
```

Create a camera intrinsics object.

```
intrinsics = cameraIntrinsics(focalLength,principalPoint,imageSize)
```

```
intrinsics =  
  cameraIntrinsics with properties:  
  
    FocalLength: [800 800]  
   PrincipalPoint: [320 240]  
     ImageSize: [480 640]  
  RadialDistortion: [0 0]  
TangentialDistortion: [0 0]  
           Skew: 0  
  IntrinsicMatrix: [3x3 double]
```

Extended Capabilities

C/C++ Code Generation

Generate C and C++ code using MATLAB® Coder™.

See Also

Apps

[Camera Calibrator](#) | [Stereo Camera Calibrator](#)

Objects

[cameraParameters](#)

Functions

[undistortImage](#)

Topics

[“Using the Single Camera Calibrator App”](#)

[“Import Camera Intrinsic Parameters from ROS”](#)

Introduced in R2017a

pcplayer

Visualize streaming 3-D point cloud data

Description

Visualize 3-D point cloud data streams from devices such as Microsoft Kinect®.

To improve performance, `pcplayer` automatically downsamples the rendered point cloud during interaction with the figure. The downsampling occurs only for rendering the point cloud and does not affect the saved points.

You can set the default center of rotation for the point cloud viewer to rotate around the axes center or around a point. Set the default behavior from the “Computer Vision Toolbox Preferences”.

Creation

Syntax

```
player = pcplayer(xlimits,ylimits,zlimits)
player = pcplayer(xlimits,ylimits,zlimits,Name,Value)
```

Description

`player = pcplayer(xlimits,ylimits,zlimits)` returns a player with `xlimits`, `ylimits`, and `zlimits` set for the axes limits.

`player = pcplayer(xlimits,ylimits,zlimits,Name,Value)` returns a player with additional properties specified by one or more `Name,Value` pair arguments.

Input Arguments

xlimits — Range of x-axis coordinates

1-by-2 vector

Range of x-axis coordinates, specified as a 1-by-2 vector in the format `[min max]`. `pcplayer` does not display data outside these limits.

ylimits — Range of y-axis coordinates

1-by-2 vector

Range of y-axis coordinates, specified as a 1-by-2 vector in the format `[min max]`. `pcplayer` does not display data outside these limits.

zlimits — Range of z-axis coordinates

1-by-2 vector

Range of z-axis coordinates, specified as a 1-by-2 vector in the format `[min max]`. `pcplayer` does not display data outside these limits.

Name-Value Pair Arguments

Specify optional comma-separated pairs of `Name`, `Value` arguments. `Name` is the argument name and `Value` is the corresponding value. `Name` must appear inside quotes. You can specify several name and value pair arguments in any order as `Name1, Value1, ..., NameN, ValueN`.

Example: `'VerticalAxisDir', 'Up'`.

MarkerSize — Diameter of marker

6 (default) | positive scalar

Diameter of marker, specified as a positive scalar. The value specifies the approximate diameter of the point marker. MATLAB graphics defines the unit as points. A marker size larger than six can reduce the rendering performance.

BackgroundColor — Background color

[0 0 0] (black) (default) | RGB triplet | hexadecimal color code | character vector

Background color, specified as an RGB triplet, hexadecimal color code, or a character vector that specifies a long or short color name.

VerticalAxis — Vertical axis

'Z' (default) | 'X' | 'Y'

Vertical axis, specified as 'X', 'Y', or 'Z'. When you reload a saved figure, any action on the figure resets the vertical axis to the z-axis.

VerticalAxisDir — Vertical axis direction

'Up' (default) | 'Down'

Vertical axis direction, specified as 'Up' or 'Down'. When you reload a saved figure, any action on the figure resets the direction to the up direction.

Parent — Axes on which to display the visualization

axes graphics object

Axes on which to display the visualization, specified as an Axes object. To create an Axes object, use the `axes` function. To display the visualization in a new figure, leave 'Parent' unspecified.

Properties**Axes — Player axes handle**

axes graphics object

Player axes handle, specified as an axes graphics object.

Usage**Color and Data Point Values in Figure**

To view point data or modify color display values, hover over the axes toolbar and select one of the following options.

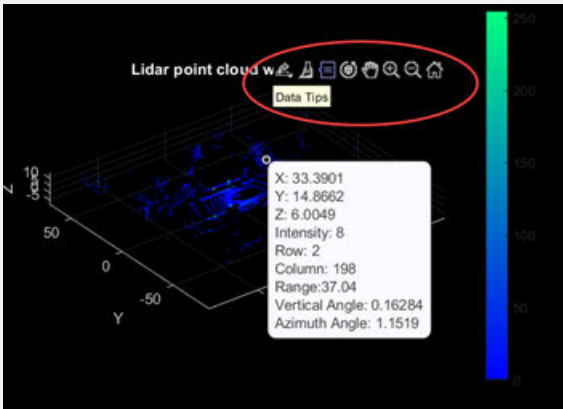
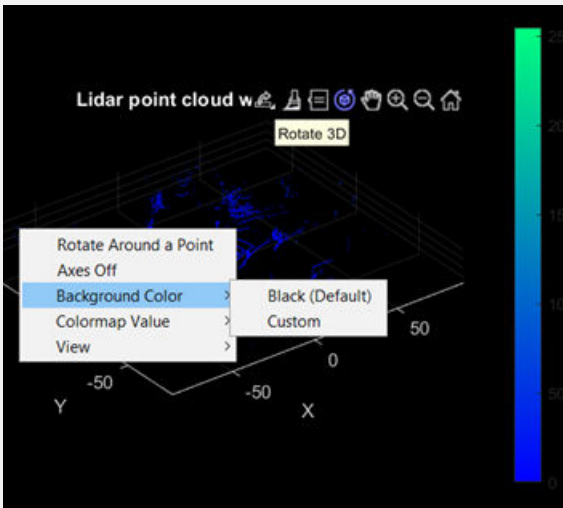
Feature	Description						
Datatip	<p>Click Data Tips to view the data point values for any point in the point cloud figure. For a normal point cloud, the Data Tips displays the x,y,z values. Additional data properties for the depth image and lidar are:</p> <table border="1" data-bbox="602 415 1476 583"> <thead> <tr> <th data-bbox="602 415 1036 457">Point Cloud Data</th> <th data-bbox="1040 415 1476 457">Data Value Properties</th> </tr> </thead> <tbody> <tr> <td data-bbox="602 464 1036 506">Depth image (RGB-D sensor)</td> <td data-bbox="1040 464 1476 506">Color, row, column</td> </tr> <tr> <td data-bbox="602 512 1036 583">Lidar</td> <td data-bbox="1040 512 1476 583">Intensity, range, azimuth angle, elevation angle, row, column</td> </tr> </tbody> </table> 	Point Cloud Data	Data Value Properties	Depth image (RGB-D sensor)	Color, row, column	Lidar	Intensity, range, azimuth angle, elevation angle, row, column
Point Cloud Data	Data Value Properties						
Depth image (RGB-D sensor)	Color, row, column						
Lidar	Intensity, range, azimuth angle, elevation angle, row, column						
Background color	<p>Click Rotate and then right-click in the figure for background options.</p> 						

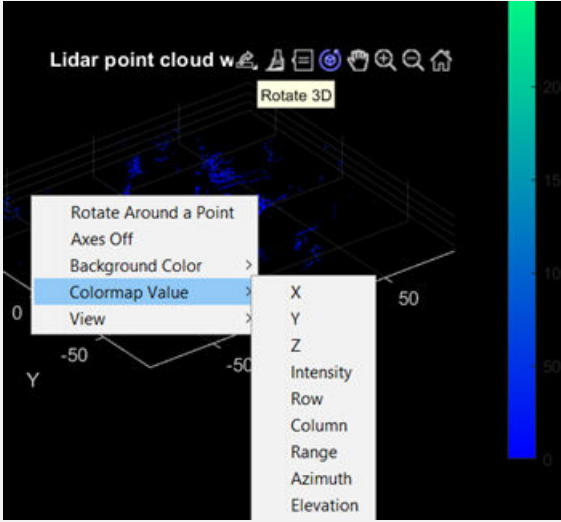
Feature	Description
Colormap value	<p>Click Rotate and then right-click in the figure for colormap options. You can modify colormap values for the coordinate and range values available, depending on the type of point cloud displayed.</p> 
View	<p>Click Rotate to change the viewing angle of the point cloud figure to the XZ, ZX, YZ, ZY, XY, or the YX plane. Click Restore View to reset the viewing angle.</p> 

OpenGL Option

pcplayer supports the 'opengl' option for the Renderer figure property only.

Object Functions

hide Hide player figure
 isOpen Visible or hidden status for player
 show Show player
 view Display point cloud

Examples

Terminate a Point Cloud Processing Loop

Create the player and add data.

```
player = pcplayer([0 1],[0 1],[0 1]);
```

Display continuous player figure. Use the `isOpen` function to check if player figure window is open.

```
while isOpen(player)
    ptCloud = pointCloud(rand(1000,3,'single'));
    view(player,ptCloud);
end
```

Terminate while-loop by closing pcplayer figure window.

See Also

`showShape` | `pcshow` | `pcshowpair` | `pcwrite` | `pcread` | `pcmerge` | `plot3` | `pcdownsample` | `pcfitplane` | `planeModel` | `pcdenoise` | `pcregistericp` | `scatter3` | `pointCloud`

Topics

“Choose Function to Visualize Detected Objects”

Introduced in R2015b

view

Display point cloud

Syntax

```
view(player,ptCloud)
view(player,xyzPoints)
view(player,xyzPoints,color)
view(player,xyzPoints,colorMap)
```

Description

`view(player,ptCloud)` displays a point cloud in the `pcplayer` figure window, `player`. The points, locations, and colors are stored in the `ptCloud` object.

`view(player,xyzPoints)` displays the points of a point cloud at the locations specified by the `xyzPoints` matrix. The color of each point is determined by the `z` value.

`view(player,xyzPoints,color)` displays a point cloud with colors specified by `color`.

`view(player,xyzPoints,colorMap)` displays a point cloud with colors specified by `colorMap`.

Examples

View Rotating 3-D Point Cloud

Load point cloud.

```
ptCloud = pcread('teapot.ply');
```

Define a rotation matrix and 3-D transform.

```
x = pi/180;
R = [ cos(x) sin(x) 0 0
      -sin(x) cos(x) 0 0
           0      0  1 0
           0      0  0 1];
```

```
tform = affine3d(R);
```

Compute `x_``y_` limits that ensure that the rotated teapot is not clipped.

```
lower = min([ptCloud.XLimits ptCloud.YLimits]);
upper = max([ptCloud.XLimits ptCloud.YLimits]);
```

```
xlimits = [lower upper];
ylimits = [lower upper];
zlimits = ptCloud.ZLimits;
```

Create the player and customize player axis labels.

```
player = pcplayer(xlimits,ylimits,zlimits);  
  
xlabel(player.Axes,'X (m)');  
ylabel(player.Axes,'Y (m)');  
zlabel(player.Axes,'Z (m)');
```

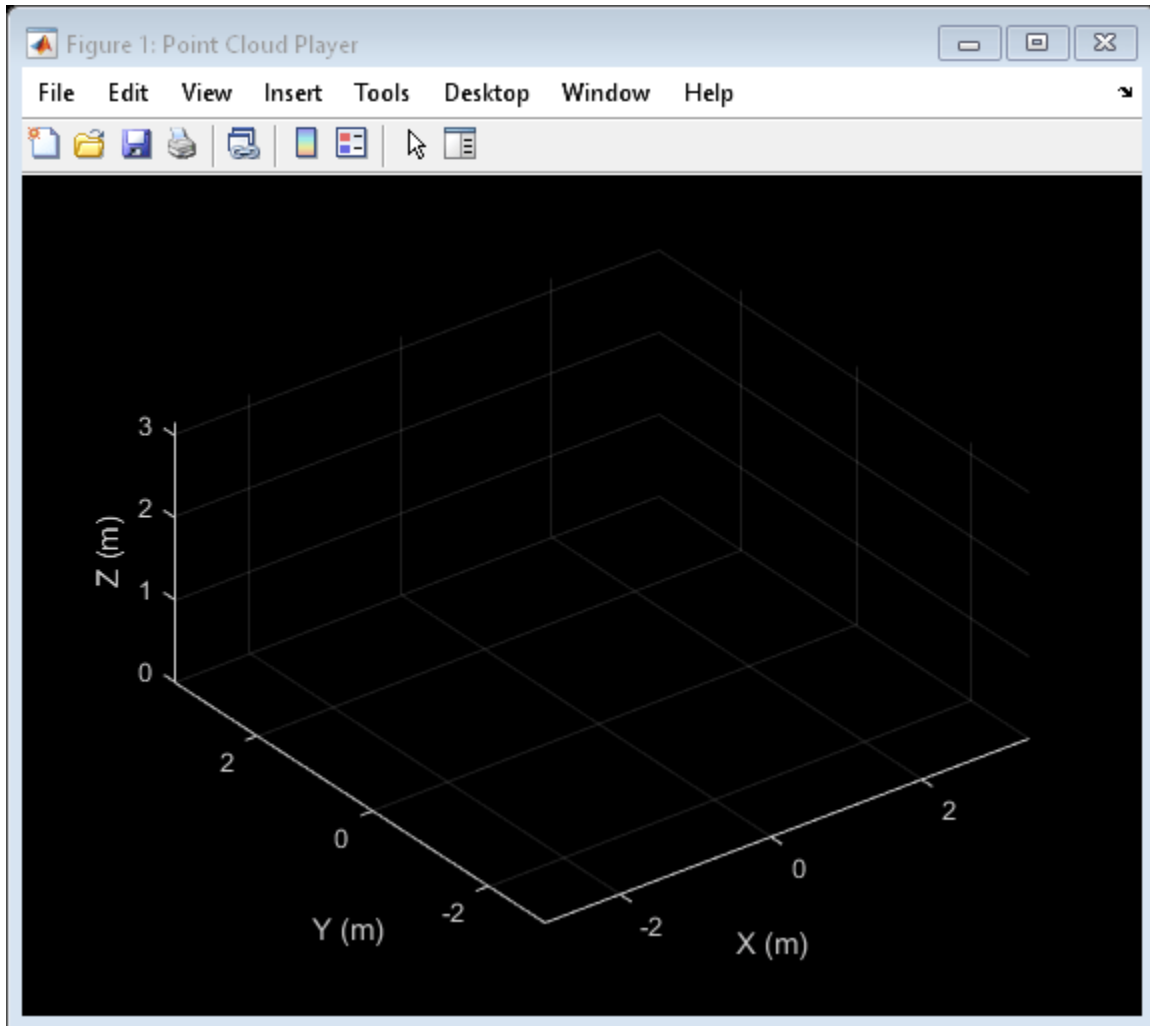

Rotate the teapot around the z-axis.

```
for i = 1:360  
    ptCloud = pctransform(ptCloud,tform);  
    view(player,ptCloud);  
end
```

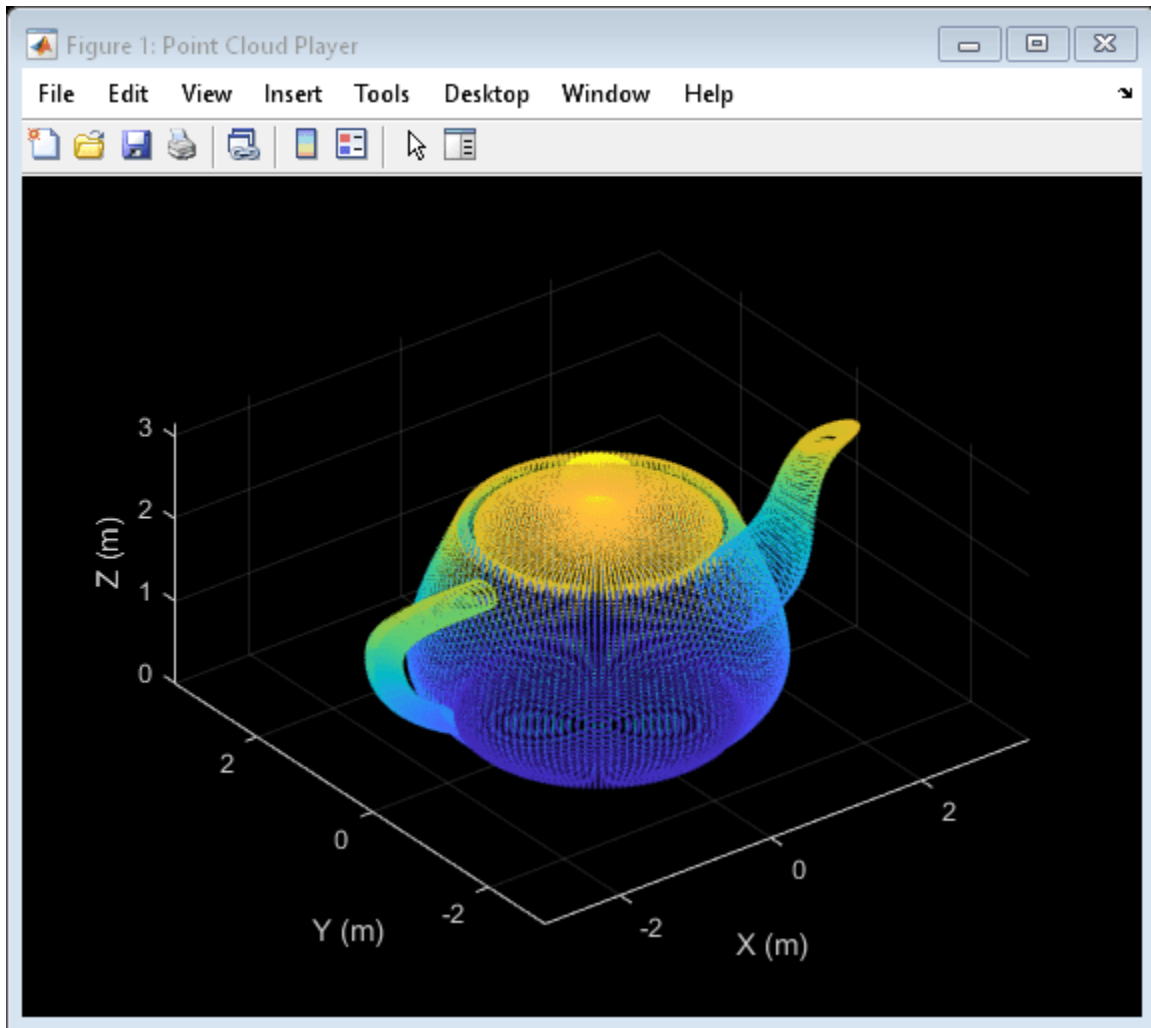

Input Arguments

ptCloud — Point cloud

pointCloud object

Point cloud, specified as a `pointCloud` object. The object contains the locations, intensities, and RGB colors to render the point cloud.

Point Cloud Property	Color Rendering Result
Location only	Maps the z-value to a color value in the current color map.
Location and Intensity	Maps the intensity to a color value in the current color map.
Location and Color	Use provided color.
Location, Intensity, and Color	Use provided color.

player – Player

pcplayer object

Player for visualizing 3-D point cloud data streams, specified as a pcplayer object.

xyzPoints – Point cloud x, y, and z locations M -by-3 numeric matrix | M -by- N -by-3 numeric matrix

Point cloud x , y , and z locations, specified as either an M -by-3 or an M -by- N -by-3 numeric matrix. The M -by- N -by-3 numeric matrix is commonly referred to as an organized point cloud. The xyzPoints numeric matrix contains M or M -by- N $[x,y,z]$ points. The z values in the numeric matrix, which generally correspond to depth or elevation, determine the color of each point.

color – Color for points in the point cloud1-by-3 RGB vector | short name of color | long name of color | M -by-3 matrix | M -by- N -by-3 matrix

Color for points in the point cloud, specified as a 1-by-3- RGB vector, an M -by-3 matrix, an M -by- N -by-3 matrix, a short color name, or a long color name. For details on color names, see the Color Value on page 2-340 table.

You can specify the same color for all points or a different color for each point. When you set color to single or double, the RGB values range between $[0, 1]$. When you set color to uint8, the values range between $[0, 255]$.

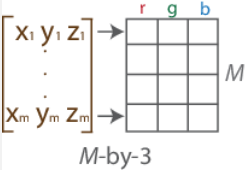
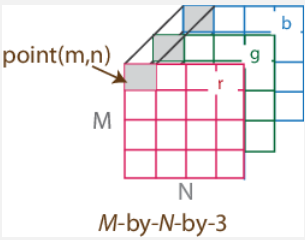
Points Input	Color Selection	Valid Values of C	
xyzPoints	Same color for all points	1-by-3 RGB vector, or a color name or short name, listed in the Color Value on page 2-340 table.	 <p>1-by-3</p>
	Different color for each point	M -by-3 matrix or M -by- N -by-3 matrix containing RGB values for each point.	 

colorMap – Point cloud color map for points M -by-1 vector | M -by- N matrix

Point cloud color map for points, specified as one of:

- M -by-1 vector

- M -by- N matrix

Points Input	Color Selection	Valid Values of C
xyzPoints	Different color for each point	<p>Vector or M-by-N matrix. The matrix must contain values that are linearly mapped to a color listed in the current colormap.</p>

More About

Color Value

Color Name	Short Name	RGB Triplet	Appearance
'red'	'r'	[1 0 0]	
'green'	'g'	[0 1 0]	
'blue'	'b'	[0 0 1]	
'cyan'	'c'	[0 1 1]	
'magenta'	'm'	[1 0 1]	
'yellow'	'y'	[1 1 0]	
'black'	'k'	[0 0 0]	
'white'	'w'	[1 1 1]	

Introduced in R2015b

pointTrack

Object for storing matching points from multiple views

Description

Creation

```
track = pointTrack(viewIDs,points)
```

Description

`track = pointTrack(viewIDs,points)` returns an object that stores matching 2-D points from multiple views. You can also create this point track object using the `findTracks` object function of the `imageviewset` object.

Input Arguments

viewIDs — View IDs of image poses

M-element vector

View IDs of image poses, specified as an *M*-element vector of scalar integers.

points — 2-D points that match across multiple image views

M-by-2 matrix

2-D points that match across multiple image views, specified as an *M*-by-2 matrix of (*x*,*y*) point coordinates. You can use the `matchFeatures` function to find these points, and then save them using this object.

Output Arguments

track — Point track object

`pointTrack` object

Point track object, returned as a `pointTrack` object. You can use this object to store matching 2-D points from multiple views. You can also create this point track object using the `findTracks` object function of the `imageviewset` object.

Examples

Create a Point Track Object

Save (*x*, *y*) points and view IDs.

```
points = [10,20;11,21;12,22];  
viewIDs = [1 2 3];
```

Create a `pointTrack` object to save points and IDs. The matched 2-D image points correspond to the same 3-D world point. Separate `pointTrack` objects are needed to track different 3-D world points across views.

```
track = pointTrack(viewIDs,points);
```

See Also

Functions

`triangulateMultiview` | `matchFeatures` | `bundleAdjustment` | `findTracks`

Objects

`imageviewset` | `vision.PointTracker`

Topics

“3-D Point Cloud Registration and Stitching”
“Coordinate Systems”

Introduced in R2016a

vision.PointTracker

Package: vision

Track points in video using Kanade-Lucas-Tomasi (KLT) algorithm

Description

The point tracker object tracks a set of points using the Kanade-Lucas-Tomasi (KLT), feature-tracking algorithm. You can use the point tracker for video stabilization, camera motion estimation, and object tracking. It works particularly well for tracking objects that do not change shape and for those that exhibit visual texture. The point tracker is often used for short-term tracking as part of a larger tracking framework.

As the point tracker algorithm progresses over time, points can be lost due to lighting variation, out of plane rotation, or articulated motion. To track an object over a long period of time, you may need to reacquire points periodically.

To track a set of points:

- 1 Create the `vision.PointTracker` object and set its properties.
- 2 Call the object with arguments, as if it were a function.

To learn more about how System objects work, see [What Are System Objects?](#)

Creation

Syntax

```
pointTracker = vision.PointTracker
pointTracker = vision.PointTracker(Name,Value)
```

Description

`pointTracker = vision.PointTracker` returns a point tracker object that tracks a set of points in a video.

`pointTracker = vision.PointTracker(Name,Value)` sets properties using one or more name-value pairs. Enclose each property name in quotes. For example, `pointTracker = vision.PointTracker('NumPyramidLevels',3)`

Initialize Tracking Process:

To initialize the tracking process, you must use `initialize` to specify the initial locations of the points and the initial video frame.

`initialize(pointTracker,points,I)` initializes points to track and sets the initial video frame. The initial locations `points`, must be an M -by-2 array of $[x\ y]$ coordinates. The initial video frame, `I`, must be a 2-D grayscale or RGB image and must be the same size and data type as the video frames passed to the `step` method.

The `detectFASTFeatures`, `detectSURFFeatures`, `detectHarrisFeatures`, and `detectMinEigenFeatures` functions are few of the many ways to obtain the initial points for tracking.

Properties

Unless otherwise indicated, properties are *nontunable*, which means you cannot change their values after calling the object. Objects lock when you call them, and the `release` function unlocks them.

If a property is *tunable*, you can change its value at any time.

For more information on changing property values, see *System Design in MATLAB Using System Objects*.

NumPyramidLevels — Number of pyramid levels

integer (default) | 3

Number of pyramid levels, specified as integer. The point tracker implementation of the KLT algorithm uses image pyramids. The tracker generates an image pyramid, where each level is reduced in resolution by a factor of two compared to the previous level. Selecting a pyramid level greater than 1, enables the algorithm to track the points at multiple levels of resolution, starting at the lowest level. Increasing the number of pyramid levels allows the algorithm to handle larger displacements of points between frames. However, computation cost also increases. Recommended values are between 1 and 4.

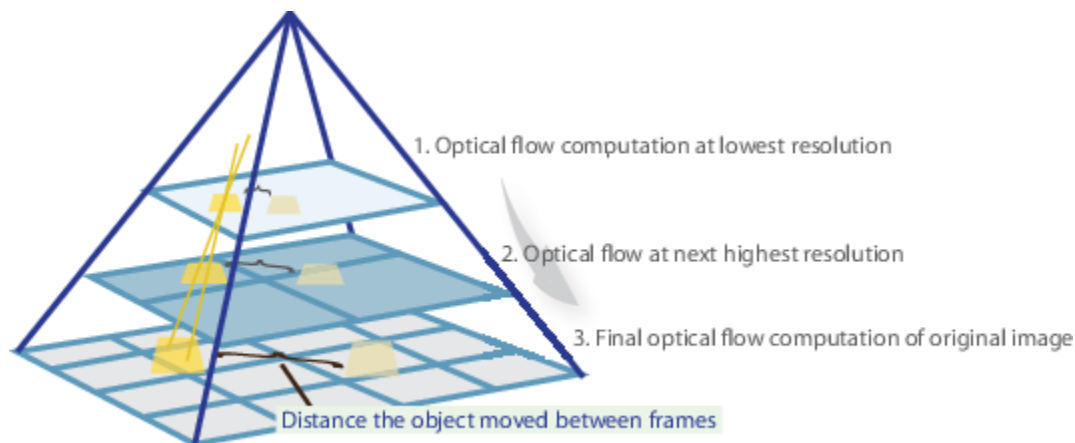

Each pyramid level is formed by down-sampling the previous level by a factor of two in width and height. The point tracker begins tracking each point in the lowest resolution level, and continues tracking until convergence. The object propagates the result of that level to the next level as the initial guess of the point locations. In this way, the tracking is refined with each level, up to the original image. Using the pyramid levels allows the point tracker to handle large pixel motions, which can comprise distances greater than the neighborhood size.

MaxBidirectionalError — Forward-backward error threshold

inf (default) | scalar

Forward-backward error threshold, specified as a scalar. If you set the value to less than `inf`, the tracker tracks each point from the previous to the current frame. It then tracks the same points back

to the previous frame. The object calculates the bidirectional error. This value is the distance in pixels from the original location of the points to the final location after the backward tracking. The corresponding points are considered invalid when the error is greater than the value set for this property. Recommended values are between 0 and 3 pixels.

Using the bidirectional error is an effective way to eliminate points that could not be reliably tracked. However, the bidirectional error requires additional computation. When you set the `MaxBidirectionalError` property to `inf`, the object does not compute the bidirectional error.

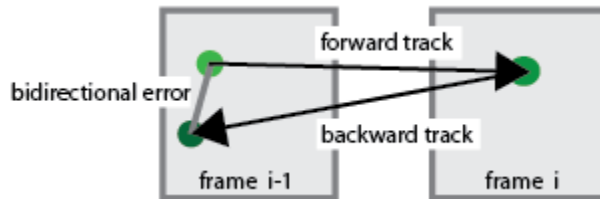

BlockSize – Size of neighborhood

[31 31] (default) | two-element vector

Size of neighborhood around each point being tracked, specified as a two-element vector, [*height*, *width*]. The *height* and *width* must be odd integers. This neighborhood defines the area for the spatial gradient matrix computation. The minimum value for `BlockSize` is [5 5]. Increasing the size of the neighborhood, increases the computation time.

MaxIterations – Maximum number of search iterations

30 (default) | integer

Maximum number of search iterations for each point, specified as an integer. The KLT algorithm performs an iterative search for the new location of each point until convergence. Typically, the algorithm converges within 10 iterations. This property sets the limit on the number of search iterations. Recommended values are between 10 and 50.

Usage

Syntax

```
[points,point_validity] = pointTracker(I)
[points,point_validity,scores] = pointTracker(I)
setPoints(pointTracker,points)
setPoints(pointTracker,points,point_validity)
```

Description

`[points,point_validity] = pointTracker(I)` tracks the points in the input frame, `I`.

`[points,point_validity,scores] = pointTracker(I)` additionally returns the confidence score for each point.

`setPoints(pointTracker,points)` sets the points for tracking. The function sets the `M`-by-2 `points` array of [*x y*] coordinates with the points to track. You can use this function if the points need to be redetected because too many of them have been lost during tracking.

`setPoints(pointTracker, points, point_validity)` additionally lets you mark points as either valid or invalid. The input logical vector `point_validity` of length M , contains the true or false value corresponding to the validity of the point to be tracked. The length M corresponds to the number of points. A false value indicates an invalid point that should not be tracked. For example, you can use this function with the `estimateGeometricTransform` function to determine the transformation between the point locations in the previous and current frames. You can mark the outliers as invalid.

Input Arguments

I — Video frame

grayscale | truecolor (RGB)

Video frame, specified as grayscale or truecolor (RGB).

Output Arguments

points — Tracked points

M -by-2 array

Tracked points, returned as an M -by-2 array of $[x, y]$ coordinates that correspond to the new locations of the points in the input frame, `I`.

point_validity — Reliability of track

M -by-1 logical array

Reliability of track for each point, returned as an M -by-1 logical array. A point can be invalid for several reasons. The point can become invalid if it falls outside of the image. Also, it can become invalid if the spatial gradient matrix computed in its neighborhood is singular. If the bidirectional error is greater than the `MaxBidirectionalError` threshold, this condition can also make the point invalid.

score — Confidence score

M -by-1 array

Confidence score between 0 and 1, returned as an M -by-1 array. The values correspond to the degree of similarity between the neighborhood around the previous location and new location of each point. These values are computed as a function of the sum of squared differences between the previous and new neighborhoods. The greatest tracking confidence corresponds to a perfect match score of 1.

Object Functions

To use an object function, specify the System object™ as the first input argument. For example, to release system resources of a System object named `obj`, use this syntax:

```
release(obj)
```

Specific to vision.PointTracker

`initialize` Initialize video frame and points to track

Common to All System Objects

`step` Run System object algorithm

release Release resources and allow changes to System object property values and input characteristics
reset Reset internal states of System object

Examples

Track a Face in Scene

Create System objects for reading and displaying video and for drawing a bounding box of the object.

```
videoReader = VideoReader('visionface.avi');  
videoPlayer = vision.VideoPlayer('Position', [100, 100, 680, 520]);
```

Read the first video frame, which contains the object, define the region.

```
objectFrame = readFrame(videoReader);  
objectRegion = [264, 122, 93, 93];
```

As an alternative, you can use the following commands to select the object region using a mouse. The object must occupy the majority of the region:

```
figure; imshow(objectFrame);
```

```
objectRegion=round(getPosition(imrect))
```

Show initial frame with a red bounding box.

```
objectImage = insertShape(objectFrame, 'Rectangle', objectRegion, 'Color', 'red');  
figure;  
imshow(objectImage);  
title('Red box shows object region');
```

Red box shows object region



Detect interest points in the object region.

```
points = detectMinEigenFeatures(im2gray(objectFrame), 'ROI', objectRegion);
```

Display the detected points.

```
pointImage = insertMarker(objectFrame, points.Location, '+', 'Color', 'white');  
figure;  
imshow(pointImage);  
title('Detected interest points');
```

Detected interest points



Create a tracker object.

```
tracker = vision.PointTracker('MaxBidirectionalError',1);
```

Initialize the tracker.

```
initialize(tracker,points.Location,objectFrame);
```

Read, track, display points, and results in each video frame.

```
while hasFrame(videoReader)  
    frame = readFrame(videoReader);  
    [points,validity] = tracker(frame);  
    out = insertMarker(frame,points(validity, :),'+');  
    videoPlayer(out);  
end
```

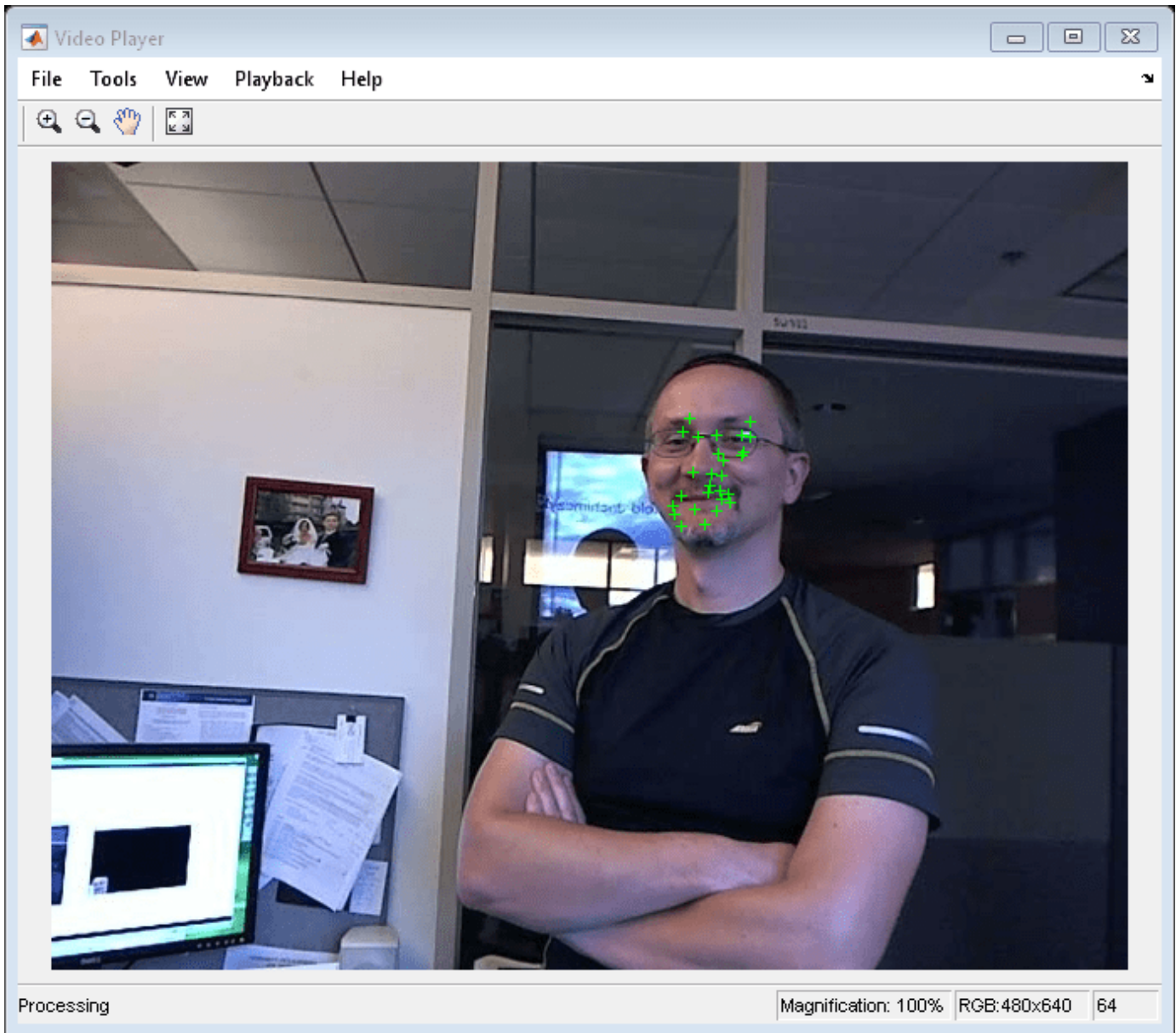

Release the video player.

```
release(videoPlayer);
```

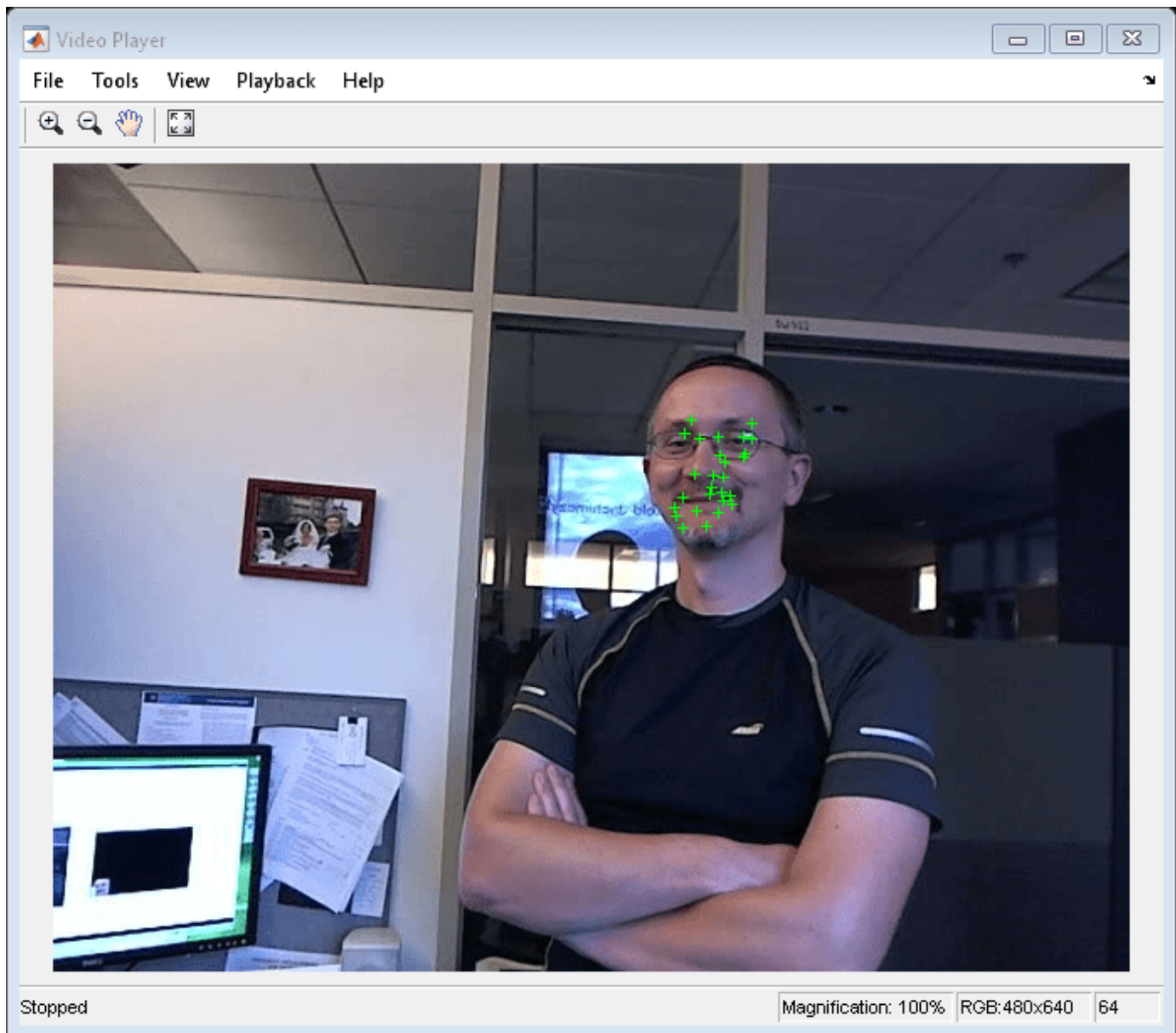

References

- [1] Lucas, Bruce D. and Takeo Kanade. "An Iterative Image Registration Technique with an Application to Stereo Vision," *Proceedings of the 7th International Joint Conference on Artificial Intelligence*, April, 1981, pp. 674-679.
- [2] Tomasi, Carlo and Takeo Kanade. *Detection and Tracking of Point Features*, Computer Science Department, Carnegie Mellon University, April, 1991.
- [3] Shi, Jianbo and Carlo Tomasi. "Good Features to Track," *IEEE Conference on Computer Vision and Pattern Recognition*, 1994, pp. 593-600.

[4] Kalal, Zdenek, Krystian Mikolajczyk, and Jiri Matas. "Forward-Backward Error: Automatic Detection of Tracking Failures," *Proceedings of the 20th International Conference on Pattern Recognition*, 2010, pages 2756-2759, 2010.

Extended Capabilities

C/C++ Code Generation

Generate C and C++ code using MATLAB® Coder™.

Usage notes and limitations:

- Generates portable C code using a C++ compiler that links to OpenCV (Version 3.4.0) libraries. See "Portable C Code Generation for Functions That Use OpenCV Library".
- See "System Objects in MATLAB Code Generation" (MATLAB Coder).

See Also

`insertMarker` | `vision.HistogramBasedTracker` | `detectSURFFeatures` | `detectHarrisFeatures` | `detectMinEigenFeatures` | `estimateGeometricTransform` | `imrect`

Topics

"Face Detection and Tracking Using CAMShift"

"Face Detection and Tracking Using the KLT Algorithm"

"Face Detection and Tracking Using Live Video Acquisition"

"Detect and Track Face"

External Websites

Object Recognition and Tracking for Augmented Reality

Detect and Track Multiple Faces in a Live Video Stream

Introduced in R2012b

viewSet

(To be removed) Object for managing data for structure-from-motion and visual odometry

Note The `viewSet` object will be removed in a future release. Use the `imageviewset` object instead. For more information, see “Compatibility Considerations”.

Description

A `viewSet` object stores views and connections between views. A view includes feature points and an absolute camera pose. A connection between two views includes point correspondences and the relative camera pose between them. Once you populate a `viewSet` object, you can use it to find point tracks across multiple views and retrieve the camera poses to be used by the `triangulateMultiview` and `bundleAdjustment` functions.

Creation

Syntax

```
vSet = viewSet
```

Description

`vSet = viewSet` creates an empty `viewSet` object. You can add views and connections using the `addView` and `addConnection` object functions.

Properties

NumViews — Number of views

integer

This property is read-only.

Number of views, stored as an integer.

Views — View attributes

four-column table

This property is read-only.

View attributes, stored as a four-column table. The table contains columns for `ViewID`, `Points`, `Orientation`, and `Location`. Use the `poses` method to obtain the IDs, orientation, and location for the points.

	1 ViewId	2 Points	3 Orientation	4 Location
1	1	574x2 single	[]	[]
2	2	503x2 single	[]	[]
3	3	540x2 single	[]	[]
4	4	472x2 single	[]	[]
5	5	421x2 single	[]	[]
6				
7				

Connections — Pairwise connections between views

five-column table

This property is read-only.

Pairwise connections between views, stored as a five-column table. The columns are ViewID1, ViewID2, Matches, RelativeOrientation, and RelativeLocation. The number of entries in the table represent the number of connections. Each index in the Matches column represents a connection between the two views indicated by the view IDs.

	1 ViewId1	2 ViewId2	3 Matches	4 RelativeOrientation	5 RelativeLocation
1	1	2	229x2 uint32	[]	[]
2	2	3	262x2 uint32	[]	[]
3	3	4	203x2 uint32	[]	[]
4	4	5	155x2 uint32	[]	[]
5					
6					
7					

Object Functions

addConnection	(To be removed) Add connection between two views
addView	(To be removed) Add new view to view set object
deleteConnection	(To be removed) Delete connection between two views from view set object
deleteView	(To be removed) Delete existing view from view set object
findTracks	(To be removed) Find matched points across multiple views
hasConnection	(To be removed) Check if connection exists between two views

hasView	(To be removed) Check if view exists
poses	(To be removed) Returns camera poses associated to views
updateConnection	(To be removed) Modify connection between two views in view set object
updateView	(To be removed) Modify existing view in view set object

Examples

Find Point Tracks Across Sequence of Images

Load images.

```
imageDir = fullfile(toolboxdir('vision'),'visiondata','structureFromMotion');
images = imageSet(imageDir);
```

Compute features for the first image.

```
I = rgb2gray(read(images, 1));
pointsPrev = detectSURFFeatures(I);
[featuresPrev,pointsPrev] = extractFeatures(I,pointsPrev);
```

Create a viewSet object.

```
vSet = viewSet;
vSet = addView(vSet,1,'Points',pointsPrev);
```

Compute features and matches for the rest of the images.

```
for i = 2:images.Count
    I = rgb2gray(read(images,i));
    points = detectSURFFeatures(I);
    [features, points] = extractFeatures(I,points);
    vSet = addView(vSet,i,'Points',points);
    pairsIdx = matchFeatures(featuresPrev,features);
    vSet = addConnection(vSet,i-1,i,'Matches',pairsIdx);
    featuresPrev = features;
end
```

Find point tracks.

```
tracks = findTracks(vSet);
```

Compatibility Considerations

viewSet object will be removed

Not recommended starting in R2020a

The `viewSet` object will be removed in a future release. Manage views and pairwise connections between views of data using the `imageviewset` object instead. The `imageviewset` object adds additional support for simultaneous localization and mapping (SLAM) data,

data used in structure-from-motion, visual odometry, and simultaneous localization and mapping (SLAM) data. View attributes can be feature descriptors, feature points, or absolute camera poses. Pairwise connections between views can be point matches, relative camera poses, or an information matrix.

See Also

[detectSURFFeatures](#) | [detectHarrisFeatures](#) | [detectMinEigenFeatures](#) | [detectFASTFeatures](#) | [detectBRISKFeatures](#) | [detectMSERFeatures](#) | [matchFeatures](#) | [bundleAdjustment](#) | [triangulateMultiview](#) | [table](#) | [pointTrack](#)

Topics

[“Structure From Motion From Multiple Views”](#)
[“Structure From Motion From Two Views”](#)
[“Code Generation for Depth Estimation From Stereo Video”](#)
[“Using the Single Camera Calibrator App”](#)
[“Structure from Motion Overview”](#)

Introduced in R2016a

addView

(To be removed) Add new view to view set object

Note The `viewSet` object and its `addView` function will be removed in a future release. Use the `imageviewset` object and its `addView` function instead. For more information, see “Compatibility Considerations”.

Syntax

```
vSet = addView(vSet,viewId)
vSet = addView(vSet,viewId,Name,Value)
```

Description

`vSet = addView(vSet,viewId)` adds the view specified by `viewID` to the specified `viewSet` object.

`vSet = addView(vSet,viewId,Name,Value)` specifies additional options using one or more name-value pair arguments.

Examples

Add View to View Set Object

Create an empty `viewSet` object.

```
vSet = viewSet;
```

Detect interest points in the image.

```
imageDir = fullfile(toolboxdir('vision'),'visiondata','structureFromMotion');
I = imread(fullfile(imageDir,'image1.jpg'));
points = detectSURFFeatures(im2gray(I));
```

Add the points to the object.

```
vSet = addView(vSet,1,'Points',points,'Orientation',eye(3),'Location',[0,0,0]);
```

Input Arguments

vSet — View set object

`viewSet` object

`viewSet` object.

viewId — Camera pose view ID

integer

Camera pose view ID in the `viewSet` object, specified as an integer.

Name-Value Pair Arguments

Specify optional comma-separated pairs of `Name`, `Value` arguments. `Name` is the argument name and `Value` is the corresponding value. `Name` must appear inside quotes. You can specify several name and value pair arguments in any order as `Name1, Value1, ..., NameN, ValueN`.

Example: `'Location', '[0,0,0]'`

Points – Image points

M-by-2 matrix | points object

Image points, specified as the comma-separated pair consisting of `'Points'` and an *M*-by-2 matrix of `[x,y]` coordinates or any points object.

Orientation – Absolute orientation of the camera

3-by-3 matrix

Absolute orientation of the camera, specified as the comma-separated pair consisting of `'Orientation'` and a 3-by-3 matrix.

Location – Absolute location of the camera

three-element vector

Absolute location of the camera, specified as the comma-separated pair consisting of `'Location'` and a three-element vector.

Output Arguments

vSet – View set object

`viewSet` object

`viewSet` object containing the added view specified by `viewId`.

Compatibility Considerations

addView function of viewSet object will be removed

Not recommended starting in R2020a

The `viewSet` object and its `addView` function will be removed in a future release. Instead, manage views and pairwise connections between views of data using use the `imageviewset` object. Add views to the `imageviewset` object using its `addView` function.

See Also

`addView` | `imageviewset`

Introduced in R2016a

updateView

(To be removed) Modify existing view in view set object

Note The `viewSet` object and its `updateView` function will be removed in a future release. Use the `imageviewset` object and its `updateView` function instead. For more information, see “Compatibility Considerations”.

Syntax

```
vSet = updateView(vSet,viewId)
vSet = updateView(vSet,viewId,Name,Value)
vSet = updateView(vSet,views)
```

Description

`vSet = updateView(vSet,viewId)` modifies the view specified by `viewId` in the specified `viewSet` object, `vSet`.

`vSet = updateView(vSet,viewId,Name,Value)` specifies additional options using one or more name-value pair arguments.

`vSet = updateView(vSet,views)` modifies a view or a set of views specified by the view table.

Examples

Update View in View Set Object

Create an empty `viewSet` object.

```
vSet = viewSet;
```

Detect interest points in the image.

```
imageDir = fullfile(toolboxdir('vision'),'visiondata','structureFromMotion');
I = imread(fullfile(imageDir,'image1.jpg'));
points = detectSURFFeatures(rgb2gray(I));
```

Add the points to the object.

```
vSet = addView(vSet,1,'Points',points);
```

Update the view to specify the camera pose.

```
vSet = updateView(vSet, 1,'Orientation',eye(3),'Location',[0,0,0]);
```

Input Arguments

vSet — View set object

viewSet object

viewSet object.

viewId — Camera pose view ID

integer

Camera pose view ID in the viewSet object, specified as an integer.

views — Camera views

table

Camera views, specified as a table. The table must contain a column named ViewID, and one or more columns named Points, Orientation, or Location.

Name-Value Pair Arguments

Specify optional comma-separated pairs of Name, Value arguments. Name is the argument name and Value is the corresponding value. Name must appear inside quotes. You can specify several name and value pair arguments in any order as Name1, Value1, ..., NameN, ValueN.

Example: Location, '[0,0,0]'

Points — Image points

M-by-2 matrix | points object

Image points, specified as the comma-separated pair consisting of 'Points' and an M-by-2 matrix of [x,y] coordinates or any points object.

Orientation — Orientation of the second camera relative to the first camera

3-by-3 matrix

Orientation of the second camera relative to the first camera, specified as the comma-separated pair consisting of 'Orientation' and a 3-by-3 matrix that represents the [x,y,z] orientation of the second camera.

Location — Location of the second camera relative to the first camera

three-element vector

Location of the second camera relative to the first camera, specified as the comma-separated pair consisting of 'Location' and a three-element vector that represents the [x,y,z] location of the second camera in the first camera's coordinate system.

Output Arguments

vSet — View set object

viewSet object

viewSet object containing the modified view specified by viewId.

Compatibility Considerations

updateView function of viewSet object will be removed

Not recommended starting in R2020a

The `viewSet` object and its `updateView` function will be removed in a future release. Instead, manage views and pairwise connections between views of data using use the `imageviewset` object. Update connections between views of the `imageviewset` object using its `updateView` function.

See Also

`imageviewset` | `updateView`

Introduced in R2016a

deleteView

(To be removed) Delete existing view from view set object

Note The `viewSet` object and its `deleteView` function will be removed in a future release. Use the `imageviewset` object and its `deleteView` function instead. For more information, see “Compatibility Considerations”.

Syntax

```
vSet = deleteView(vSet,viewId)
```

Description

`vSet = deleteView(vSet,viewId)` deletes an existing view or a set of views from the specified `viewSet` object,`vSet`.

Examples

Delete a View from View Set Object

Create an empty `viewSet` object.

```
vSet = viewSet;
```

Detect interest points in the image.

```
imageDir = fullfile(toolboxdir('vision'),'visiondata','structureFromMotion');  
I = imread(fullfile(imageDir,'image1.jpg'));  
points = detectSURFFeatures(im2gray(I));
```

Add a view.

```
vSet = addView(vSet,1,'Points',points);
```

Delete the view.

```
vSet = deleteView(vSet,1);
```

Input Arguments

vSet — View set object

`viewSet` object

A `viewSet` object.

viewId — View IDs

integer scalar | vector

View IDs, specified as an integer scalar for a single view, or as a vector of integers for a set of views.

Output Arguments

vSet — View set object

viewSet object

viewSet object.

Compatibility Considerations

deleteView function of viewSet object will be removed

Not recommended starting in R2020a

The viewSet object and its deleteView function will be removed in a future release. Instead, manage views and pairwise connections between views of data using use the imageviewset object. Delete views from the imageviewset object using its deleteView function.

See Also

imageviewset | deleteView

Introduced in R2016a

hasView

(To be removed) Check if view exists

Note The `viewSet` object and its `hasView` function will be removed in a future release. Use the `imageviewset` object and its `hasView` function instead. For more information, see “Compatibility Considerations”.

Syntax

```
tf = hasView(vSet,viewId)
```

Description

`tf = hasView(vSet,viewId)` returns 1 if the view specified by `viewID` exists and 0 if it does not exist.

Examples

Check If View Exists

Create an empty `viewSet` object.

```
vSet = viewSet;
```

Detect interest points in the image.

```
imageDir = fullfile(toolboxdir('vision'),'visiondata','structureFromMotion');  
I = imread(fullfile(imageDir,'image1.jpg'));  
points = detectSURFFeatures(im2gray(I));
```

Add a new view.

```
vSet = addView(vSet, 1,'Points',points);
```

Confirm that the view with ID 1 exists.

```
tf = hasView(vSet,1);
```

Input Arguments

vSet — View set object

`viewSet` object

`viewSet` object.

viewId — View ID

integer

View ID in the `viewSet` object, specified as an integer.

Output Arguments

tf — Validity of view connection

logical

Validity of view connection, returned as a logical 1 or 0.

Compatibility Considerations

hasView function of viewSet object will be removed

Not recommended starting in R2020a

The `viewSet` object and its `hasView` function will be removed in a future release. Instead, manage views and pairwise connections between views of data using use the `imageviewset` object. Check if a view exists in the `imageviewset` object using its `hasView` function.

See Also

`imageviewset` | `hasView`

Introduced in R2016a

addConnection

(To be removed) Add connection between two views

Note The `viewSet` object and its `addConnection` function will be removed in a future release. Use the `imageviewset` object and its `addConnection` function instead. For more information, see “Compatibility Considerations”.

Syntax

```
vSet = addConnection(vSet,viewId1,viewId2)
vSet = addConnection(vSet,viewId1,viewId2,Name,Value)
```

Description

`vSet = addConnection(vSet,viewId1,viewId2)` adds a connection between two views in the specified `viewSet` object, `vSet`.

`vSet = addConnection(vSet,viewId1,viewId2,Name,Value)` specifies additional options using one or more name-value pair arguments.

Examples

Add Connection Between Two Views

Create an empty `viewSet` object.

```
vSet = viewSet;
```

Read a pair of images.

```
imageDir = fullfile(toolboxdir('vision'),'visiondata','structureFromMotion');
I1 = im2gray(imread(fullfile(imageDir,'image1.jpg')));
I2 = im2gray(imread(fullfile(imageDir,'image2.jpg')));
```

Detect interest points in the two images.

```
points1 = detectSURFFeatures(I1);
points2 = detectSURFFeatures(I2);
```

Add the points to the `viewSet` object.

```
vSet = addView(vSet,1,'Points',points1);
vSet = addView(vSet,2,'Points',points2);
```

Extract feature descriptors from both images.

```
features1 = extractFeatures(I1,points1);
features2 = extractFeatures(I2,points2);
```

Match features and store the matches.

```
indexPairs = matchFeatures(features1, features2);
```

Add the connection between the two views.

```
vSet = addConnection(vSet, 1, 2, 'Matches', indexPairs);
```

Input Arguments

vSet — View set object

viewSet object

viewSet object.

viewId1 — View ID 1

integer

View ID 1 in the viewSet object, specified as an integer.

viewId2 — View ID 2

integer

View ID 2 in the viewSet object, specified as an integer.

Name-Value Pair Arguments

Specify optional comma-separated pairs of **Name**, **Value** arguments. **Name** is the argument name and **Value** is the corresponding value. **Name** must appear inside quotes. You can specify several name and value pair arguments in any order as **Name1**, **Value1**, ..., **NameN**, **ValueN**.

Example: 'Location', '[0,0,0]'

Matches — Indices of matched points between two views

M-by-2 matrix

Indices of matched points between two views, specified as the comma-separated pair consisting of 'Matches' and an *M*-by-2 matrix.

Orientation — Orientation of the second camera relative to the first camera

3-by-3 matrix

Orientation of the second camera relative to the first camera, specified as the comma-separated pair consisting of 'Orientation' and a 3-by-3 matrix that represents the $[x,y,z]$ orientation of the second camera.

Location — Location of the second camera relative to the first camera

three-element vector

Location of the second camera relative to the first camera, specified as the comma-separated pair consisting of 'Location' and a three-element vector that represents the $[x,y,z]$ location of the second camera in the first camera's coordinate system.

Output Arguments

vSet — View set object

viewSet object

viewSet object.

Compatibility Considerations

addConnection function of viewSet object will be removed

Not recommended starting in R2020a

The viewSet object and its addConnection function will be removed in a future release. Instead, manage views and pairwise connections between views of data using use the imageviewset object. Add connections to the imageviewset object using its addConnection function.

See Also

addConnection | imageviewset

Introduced in R2016a

updateConnection

(To be removed) Modify connection between two views in view set object

Note The `viewSet` object and its `updateConnection` function will be removed in a future release. Use the `imageviewset` object and its `updateConnection` function instead. For more information, see “Compatibility Considerations”.

Syntax

```
vSet = updateConnection(vSet,viewId1,viewId2)
vSet = updateConnection(vSet,viewId1,viewId2,Name,Value)
```

Description

`vSet = updateConnection(vSet,viewId1,viewId2)` modifies a connection between two views in the specified view set object, `vSet`.

`vSet = updateConnection(vSet,viewId1,viewId2,Name,Value)` specifies additional options using one or more name-value pair arguments. Unspecified arguments have default values.

Examples

Update Connection Between Two Views in View Set Object

Create an empty `viewSet` object.

```
vSet = viewSet;
```

Read a pair of images.

```
imageDir = fullfile(toolboxdir('vision'),'visiondata','structureFromMotion');
I1 = rgb2gray(imread(fullfile(imageDir,'image1.jpg')));
I2 = rgb2gray(imread(fullfile(imageDir,'image2.jpg')));
```

Detect interest points in the two images.

```
points1 = detectSURFFeatures(I1);
points2 = detectSURFFeatures(I2);
```

Add the points to the `viewSet` object.

```
vSet = addView(vSet, 1,'Points',points1);
vSet = addView(vSet, 2,'Points',points2);
```

Extract feature descriptors.

```
features1 = extractFeatures(I1,points1);
features2 = extractFeatures(I2,points2);
```

Match features and store the matches.

```
indexPairs = matchFeatures(features1, features2);  
vSet = addConnection(vSet,1,2,'Matches',indexPairs);
```

Update the connection to store a relative pose between the views.

```
vSet = updateConnection(vSet,1,2,'Orientation', eye(3), 'Location', [1 0 0]);
```

Input Arguments

vSet — View set object

viewSet object

viewSet object.

viewId1 — View ID 1

integer

View ID 1 in the viewSet object, specified as an integer.

viewId2 — View ID 2

integer

View ID 2 in the viewSet object, specified as an integer.

Name-Value Pair Arguments

Specify optional comma-separated pairs of **Name**, **Value** arguments. **Name** is the argument name and **Value** is the corresponding value. **Name** must appear inside quotes. You can specify several name and value pair arguments in any order as **Name1**, **Value1**, ..., **NameN**, **ValueN**.

Example: 'Location', '[0,0,0]'

Matches — Indices of matched points between two views

M-by-2 matrix

Indices of matched points between two views, specified as the comma-separated pair consisting of 'Matches' and an *M*-by-2 matrix.

Orientation — Orientation of the second camera relative to the first camera

3-by-3 matrix

Orientation of the second camera relative to the first camera, specified as the comma-separated pair consisting of 'Orientation' and a 3-by-3 matrix that represents the $[x,y,z]$ orientation of the second camera.

Location — Location of the second camera relative to the first camera

three-element vector

Location of the second camera relative to the first camera, specified as the comma-separated pair consisting of 'Location' and a three-element vector that represents the $[x,y,z]$ location of the second camera in the first camera's coordinate system.

Output Arguments

vSet — View set object

viewSet object

viewSet object containing the modified connection.

Compatibility Considerations

updateConnection function of viewSet object will be removed

Not recommended starting in R2020a

The viewSet object and its updateConnection function will be removed in a future release. Instead, manage views and pairwise connections between views of data using use the imageviewset object. Update connections between views of the imageviewset object using its updateConnection function.

See Also

imageviewset | updateConnection

Introduced in R2016a

deleteConnection

(To be removed) Delete connection between two views from view set object

Note The `viewSet` object and its `deleteConnection` function will be removed in a future release. Use the `imageviewset` object and its `deleteConnection` function instead. For more information, see “Compatibility Considerations”.

Syntax

```
vSet = deleteConnection(vSet,viewId1,viewId2)
```

Description

`vSet = deleteConnection(vSet,viewId1,viewId2)` deletes a connection between two views in the specified `viewSet` object, `vSet`.

Examples

Delete a Connection Between Two Views In View Set Object

Create an empty `viewSet` object.

```
vSet = viewSet;
```

Read a pair of images.

```
imageDir = fullfile(toolboxdir('vision'),'visiondata','structureFromMotion');  
I1 = im2gray(imread(fullfile(imageDir,'image1.jpg')));  
I2 = im2gray(imread(fullfile(imageDir,'image2.jpg')));
```

Detect interest points in the two images.

```
points1 = detectSURFFeatures(I1);  
points2 = detectSURFFeatures(I2);
```

Add the points to the `viewSet` object.

```
vSet = addView(vSet,1,'Points',points1);  
vSet = addView(vSet,2,'Points',points2);
```

Extract feature descriptors.

```
features1 = extractFeatures(I1,points1);  
features2 = extractFeatures(I2,points2);
```

Match features and store the matches.

```
indexPairs = matchFeatures(features1, features2);  
vSet = addConnection(vSet,1,2,'Matches',indexPairs);
```

Delete the connection between the views.

```
vSet = deleteConnection(vSet,1,2);
```

Input Arguments

vSet – View set object

viewSet object

viewSet object.

viewId1 – View ID 1

integer

View ID 1 in the viewSet object, specified as an integer.

viewId2 – View ID 2

integer

View ID 2 in the viewSet object, specified as an integer.

Output Arguments

vSet – View set object

viewSet object

viewSet object.

Compatibility Considerations

deleteConnection function of viewSet object will be removed

Not recommended starting in R2020a

The viewSet object and its deleteConnection function will be removed in a future release. Instead, manage views and pairwise connections between views of data using use the imageviewset object. Delete connections from the imageviewset object using its deleteConnection function.

See Also

imageviewset | deleteConnection

Introduced in R2016a

hasConnection

(To be removed) Check if connection exists between two views

Note The `viewSet` object and its `hasConnection` function will be removed in a future release. Use the `imageViewset` object and its `hasConnection` function instead. For more information, see “Compatibility Considerations”.

Syntax

```
tf = hasConnection(vSet,viewId1,viewId2)
```

Description

`tf = hasConnection(vSet,viewId1,viewId2)` returns true if both views exist and have a connection.

Examples

Check Whether a Connection Exists Between Two Views

Create an empty `viewSet` object.

```
vSet = viewSet;
```

Add a pair of views.

```
vSet = addView(vSet,1);  
vSet = addView(vSet,2);
```

Add a connection.

```
vSet = addConnection(vSet,1,2);
```

Confirm that the connection exists.

```
tf = hasConnection(vSet,1,2);
```

Input Arguments

vSet — View set object

`viewSet` object

`viewSet` object.

viewId1 — View ID 1

integer

View ID 1 in the `viewSet` object, specified as an integer.

viewId2 – View ID 2

integer

View ID 2 in the `viewSet` object, specified as an integer.

Output Arguments**tf – Validity of view connection**

logical

Validity of view connection, returned as a logical 1 or 0.

Compatibility Considerations**hasConnection function of viewSet object will be removed***Not recommended starting in R2020a*

The `viewSet` object and its `hasConnection` function will be removed in a future release. Instead, manage views and pairwise connections between views of data using use the `imageviewset` object. Check if a connection between views exists in the `imageviewset` object using its `hasConnection` function.

See Also`imageviewset` | `hasConnection`**Introduced in R2016a**

findTracks

(To be removed) Find matched points across multiple views

Note The `viewSet` object and its `findTracks` function will be removed in a future release. Use the `imageviewset` object and its `findTracks` function instead. For more information, see “Compatibility Considerations”.

Syntax

```
tracks = findTracks(vSet)
tracks = findTracks(vSet,viewIds)
```

Description

`tracks = findTracks(vSet)` finds point tracks across multiple views.

`tracks = findTracks(vSet,viewIds)` finds point tracks across a subset of views.

Examples

Find Point Tracks Across Sequence of Images

Load images.

```
imageDir = fullfile(toolboxdir('vision'),'visiondata','structureFromMotion');
images = imageSet(imageDir);
```

Compute features for the first image.

```
I = rgb2gray(read(images, 1));
pointsPrev = detectSURFFeatures(I);
[featuresPrev,pointsPrev] = extractFeatures(I,pointsPrev);
```

Create a `viewSet` object.

```
vSet = viewSet;
vSet = addView(vSet,1,'Points',pointsPrev);
```

Compute features and matches for the rest of the images.

```
for i = 2:images.Count
    I = rgb2gray(read(images,i));
    points = detectSURFFeatures(I);
    [features, points] = extractFeatures(I,points);
    vSet = addView(vSet,i,'Points',points);
    pairsIdx = matchFeatures(featuresPrev,features);
    vSet = addConnection(vSet,i-1,i,'Matches',pairsIdx);
    featuresPrev = features;
end
```

Find point tracks.

```
tracks = findTracks(vSet);
```

Input Arguments

vSet — View set object

viewSet object

viewSet object.

viewIds — Subset of views

vector of integers

Subset of views in the viewSet object, specified as a vector of integers.

Output Arguments

tracks — Point track objects

array of pointTrack objects

Point track objects, returned as an array of pointTrack objects. Each track contains 2-D projections of the same 3-D world point.

Compatibility Considerations

findTracks function of viewSet object will be removed

Not recommended starting in R2020a

The viewSet object and its findTracks function will be removed in a future release. Instead, manage views and pairwise connections between views of data using use the imageviewset object. Finds point track across views of the imageviewset object using its findTracks function.

See Also

imageviewset | findTracks

Introduced in R2016a

poses

(To be removed) Returns camera poses associated to views

Note The `viewSet` object and its `poses` function will be removed in a future release. Use the `imageViewset` object and its `poses` function instead. For more information, see “Compatibility Considerations”.

Syntax

```
cameraPoses = poses(vSet)
cameraPoses = poses(vSet,viewIds)
```

Description

`cameraPoses = poses(vSet)` returns the camera poses that correspond to the views contained in the input `viewSet` object, `vSet`.

`cameraPoses = poses(vSet,viewIds)` returns the camera poses that correspond to a subset of views specified by the vector `viewIds`.

Examples

Retrieve Camera Poses from View Set Object

Create an empty `viewSet` object.

```
vSet = viewSet;
```

Add views to the object.

```
vSet = addView(vSet,1,'Orientation',eye(3),'Location',[0,0,0]);
vSet = addView(vSet,2,'Orientation',eye(3),'Location',[1,0,0]);
```

Retrieve the absolute camera poses.

```
camPoses = poses(vSet);
```

Input Arguments

vSet – View set object

`viewSet` object

`viewSet` object.

viewIds – View IDs

integer scalar | vector

View IDs, specified as an integer scalar for a single view, or as a vector of integers for a set of views.

Output Arguments

cameraPoses — Camera pose information

three-column table

Camera pose information, returned as a three-column table. The table contains columns for `ViewId`, `Orientation`, and `Location`. The view IDs correspond to the IDs in the `viewSet` object. The orientations are specified as 3-by-3 rotation matrices and locations are specified as three-element vectors. You can pass the `cameraPoses` table to the `triangulateMultiview` and the `bundleAdjustment` functions.

Compatibility Considerations

poses function of viewSet object will be removed

Not recommended starting in R2020a

The `viewSet` object and its `poses` function will be removed in a future release. Instead, manage views and pairwise connections between views of data using use the `imageviewset` object. Return camera poses associated with views of the `imageviewset` object using its `poses` function.

See Also

`triangulateMultiview` | `bundleAdjustment` | `imageviewset` | `poses`

Introduced in R2016a

acfObjectDetector

Detect objects using aggregate channel features

Description

The `acfObjectDetector` object detects objects from an image, using the aggregate channel features (ACF) object detector. To detect objects in an image, pass the trained detector to the `detect` function.

The ACF object detector recognizes specific objects in images, based on the training images and the object ground truth locations used with the `trainACFObjectDetector` function.

Creation

Create an `acfObjectDetector` object by calling the `trainACFObjectDetector` function with training data.

```
detector = trainACFObjectDetector(trainingData,...)
```

Syntax

```
detector = acfObjectDetector(detectorStruct.Classifier,  
detectorStruct.TrainingOptions)
```

Description

`detector = acfObjectDetector(detectorStruct.Classifier, detectorStruct.TrainingOptions)` creates an `acfObjectDetector` object that is identical to an existing `acfObjectDetector` object using the object properties `Classifier` and `TrainingOptions`, which are stored in the `detectorStruct` structure fields. Use this syntax to recreate an ACF object detector for code generation.

Input Arguments

detectorStruct.Classifier — Pretrained `acfObjectDetector` object classifier

structure field

Pretrained `acfObjectDetector` object classifier, specified as a structure field. To get the object property `Classifier`, convert the pretrained `acfObjectDetector` object to a `detectorStruct` structure by using the `toStruct` function. Then, use dot notation.

detectorStruct.TrainingOptions — Pretrained `acfObjectDetector` object training options

structure field

Pretrained `acfObjectDetector` object training options, specified as a structure field. To get the object property `TrainingOptions`, convert the pretrained `acfObjectDetector` object to a `detectorStruct` structure by using the `toStruct` function. Then, use dot notation.

Properties

ModelName — Name of classification model

character vector | string scalar

Name of the classification model, specified as a character vector or string scalar. By default, the name is set to the heading of the second column of the `trainingData` table specified in the `trainACFObjectDetector` function. You can modify this name after creating your `acfObjectDetector` object.

Example: 'stopSign'

ObjectTrainingSize — Size of training images

[height width] vector

This property is read-only.

Size of training images, specified as a [height width] vector.

Example: [100 100]

NumWeakLearners — Number of weak learners

integer

This property is read-only.

Number of weak learners used in the detector, specified as an integer. `NumWeakLearners` is less than or equal to the maximum number of weak learners for the last training stage. To restrict this maximum, you can use the 'MaxWeakLearners' name-value pair in the `trainACFObjectDetector` function.

Object Functions

`detect` Detect objects using ACF object detector

`toStruct` Convert a trained aggregate channel features (ACF) object detector into structure

Examples

Train Stop Sign Detector Using ACF Object Detector

Use the `trainACFObjectDetector` with training images to create an ACF object detector that can detect stop signs. Test the detector with a separate image.

Load the training data.

```
load('stopSignsAndCars.mat')
```

Select the ground truth for stop signs. These ground truth is the set of known locations of stop signs in the images.

```
stopSigns = stopSignsAndCars(:,1:2);
```

Add the full path to the image files.

```
stopSigns.imageFilename = fullfile(toolboxdir('vision'),...
    'visiondata',stopSigns.imageFilename);
```

Train the ACF detector. You can turn off the training progress output by specifying 'Verbose', false as a Name, Value pair.

```
acfDetector = trainACFObjectDetector(stopSigns, 'NegativeSamplesFactor', 2);
```

```
ACF Object Detector Training
The training will take 4 stages. The model size is 34x31.
Sample positive examples(~100% Completed)
Compute approximation coefficients...Completed.
Compute aggregated channel features...Completed.
-----
Stage 1:
Sample negative examples(~100% Completed)
Compute aggregated channel features...Completed.
Train classifier with 42 positive examples and 84 negative examples...Completed.
The trained classifier has 19 weak learners.
-----
Stage 2:
Sample negative examples(~100% Completed)
Found 84 new negative examples for training.
Compute aggregated channel features...Completed.
Train classifier with 42 positive examples and 84 negative examples...Completed.
The trained classifier has 20 weak learners.
-----
Stage 3:
Sample negative examples(~100% Completed)
Found 84 new negative examples for training.
Compute aggregated channel features...Completed.
Train classifier with 42 positive examples and 84 negative examples...Completed.
The trained classifier has 54 weak learners.
-----
Stage 4:
Sample negative examples(~100% Completed)
Found 84 new negative examples for training.
Compute aggregated channel features...Completed.
Train classifier with 42 positive examples and 84 negative examples...Completed.
The trained classifier has 61 weak learners.
-----
ACF object detector training is completed. Elapsed time is 20.1934 seconds.
```

Test the ACF detector on a test image.

```
img = imread('stopSignTest.jpg');
[bboxes,scores] = detect(acfDetector,img);
```

Display the detection results and insert the bounding boxes for objects into the image.

```
for i = 1:length(scores)
    annotation = sprintf('Confidence = %.1f',scores(i));
    img = insertObjectAnnotation(img, 'rectangle', bboxes(i,:), annotation);
end

figure
imshow(img)
```



Recreate ACF Object Detector for Code Generation

Load the ACF stop sign detector from the `stopSignDetector.mat` file, which is present in the current working folder as a supporting file.

```
stopSignDetector = load('stopSignDetectorACF.mat');
detector = stopSignDetector.detector
```

```
detector =
```

```
    acfObjectDetector with properties:
```

```
        ModelName: 'stopSign'
    ObjectTrainingSize: [34 31]
        NumWeakLearners: 61
```

Convert the detector into a structure by using the `toStruct` function.

```
detectorStruct = toStruct(detector);
```

To generate code, pass the structure to a MATLAB function. Then inside the MATLAB function, create an identical ACF stop sign detector using the existing detector properties.

```
detector1 = acfObjectDetector(detectorStruct.Classifier,detectorStruct.TrainingOptions)
```

```
detector1 =
```

acfObjectDetector with properties:

```
    ModelName: 'stopSign'  
ObjectTrainingSize: [34 31]  
    NumWeakLearners: 61
```

You can pass `detector1` to the `detect` function as an input to detect stop signs from images.

References

- [1] Dollar, P., R. Appel, S. Belongie, and P. Perona. "Fast Feature Pyramids for Object Detection." *Pattern Analysis and Machine Intelligence, IEEE Transactions*. Vol. 36, Issue 8, 2014, pp. 1532-1545.

Extended Capabilities

C/C++ Code Generation

Generate C and C++ code using MATLAB® Coder™.

Usage notes and limitations:

- Use the `toStruct` function to pass the `acfObjectDetector` object into generated code. For more information, see "Generate Code for Detecting Objects in Images by Using ACF Object Detector".

See Also

Apps

[Image Labeler](#) | [Video Labeler](#)

Functions

[trainACFObjectDetector](#) | [detectPeopleACF](#) | [trainCascadeObjectDetector](#) | [groundTruth](#)

Introduced in R2017a

rcnnObjectDetector

Detect objects using R-CNN deep learning detector

Description

The `rcnnObjectDetector` object detects objects from an image, using a R-CNN (regions with convolution neural networks) object detector. To detect objects in an image, pass the trained detector to the `detect` function. To classify image regions, pass the detector to the `classifyRegions` function.

Use of the `rcnnObjectDetector` requires Statistics and Machine Learning Toolbox™ and Deep Learning Toolbox.

When using the `detect` or `classifyRegions` functions with `rcnnObjectDetector`, use of a CUDA enabled NVIDIA GPU is highly recommended. The GPU reduces computation time significantly. Usage of the GPU requires Parallel Computing Toolbox. For information about the supported compute capabilities, see “GPU Support by Release” (Parallel Computing Toolbox).

Creation

Create a `rcnnObjectDetector` object by calling the `trainRCNNObjectDetector` function with training data (requires Deep Learning Toolbox).

```
detector = trainRCNNObjectDetector(trainingData,...)
```

Properties

Network — Series network object

SeriesNetwork | DAGNetwork

Series network object representing the convolutional neural network (CNN), specified as an `SeriesNetwork` or `DAGNetwork`. The object is used within the R-CNN detector.

RegionProposalFcn — Custom region proposal

function handle

Custom region proposal function handle, specified as a function name. A custom function `proposalFcn` must have the following functional form:

```
[bboxes,scores] = proposalFcn(I)
```

The input argument `I` is an image. The function must return rectangular bounding boxes in an M -by-4 array. Each row of `bboxes` contains a four-element vector, $[x,y,width,height]$, that specifies the upper-left corner and size of a bounding box in pixels. The function must also return a score for each bounding box in an M -by-1 vector. Higher scores indicate that the bounding box is more likely to contain an object.

ClassNames — Object class names

cell array

Object class names, specified as a cell array. The array contains the names of the object classes the R-CNN detector was trained to find.

BoxRegressionLayer — Bounding box regression layer

character vector

This property is read-only.

Bounding box regression layer name, specified as a character vector. This property is set during training using the `BoxRegressionLayer` argument of `trainRCNNObjectDetector`.

Object Functions

`detect` Detect objects using R-CNN deep learning detector
`classifyRegions` Classify objects in image regions using R-CNN object detector

Examples

Train R-CNN Stop Sign Detector

Load training data and network layers.

```
load('rcnnStopSigns.mat', 'stopSigns', 'layers')
```

Add the image directory to the MATLAB path.

```
imDir = fullfile(matlabroot, 'toolbox', 'vision', 'visiondata', ...
    'stopSignImages');
addpath(imDir);
```

Set network training options to use mini-batch size of 32 to reduce GPU memory usage. Lower the `InitialLearningRate` to reduce the rate at which network parameters are changed. This is beneficial when fine-tuning a pre-trained network and prevents the network from changing too rapidly.

```
options = trainingOptions('sgdm', ...
    'MiniBatchSize', 32, ...
    'InitialLearnRate', 1e-6, ...
    'MaxEpochs', 10);
```

Train the R-CNN detector. Training can take a few minutes to complete.

```
rcnn = trainRCNNObjectDetector(stopSigns, layers, options, 'NegativeOverlapRange', [0 0.3]);
```

```
*****
Training an R-CNN Object Detector for the following object classes:
```

```
* stopSign
```

```
Step 1 of 3: Extracting region proposals from 27 training images...done.
```

```
Step 2 of 3: Training a neural network to classify objects in training data...
```

```
=====
| Epoch      | Iteration  | Time Elapsed | Mini-batch | Mini-batch | Base Learning |
|            |            | (seconds)    | Loss       | Accuracy   | Rate          |
|            |            |              |            |            |              |
=====
```

3	50	9.27	0.2895	96.88%	0.000001
5	100	14.77	0.2443	93.75%	0.000001
8	150	20.29	0.0013	100.00%	0.000001
10	200	25.94	0.1524	96.88%	0.000001

Network training complete.

Step 3 of 3: Training bounding box regression models for each object class...100.00%...done.

R-CNN training complete.

Test the R-CNN detector on a test image.

```
img = imread('stopSignTest.jpg');
```

```
[bbox, score, label] = detect(rcnn, img, 'MiniBatchSize', 32);
```

Display strongest detection result.

```
[score, idx] = max(score);
```

```
bbox = bbox(idx, :);
```

```
annotation = sprintf('%s: (Confidence = %f)', label(idx), score);
```

```
detectedImg = insertObjectAnnotation(img, 'rectangle', bbox, annotation);
```

```
figure
```

```
imshow(detectedImg)
```



Remove the image directory from the path.

```
rmpath(imDir);
```

Resume Training an R-CNN Object Detector

Resume training an R-CNN object detector using additional data. To illustrate this procedure, half the ground truth data will be used to initially train the detector. Then, training is resumed using all the data.

Load training data and initialize training options.

```
load('rcnnStopSigns.mat', 'stopSigns', 'layers')

stopSigns.imageFilename = fullfile(toolboxdir('vision'),'visiondata', ...
    stopSigns.imageFilename);

options = trainingOptions('sgdm', ...
    'MiniBatchSize', 32, ...
    'InitialLearnRate', 1e-6, ...
    'MaxEpochs', 10, ...
    'Verbose', false);
```

Train the R-CNN detector with a portion of the ground truth.

```
rcnn = trainRCNNObjectDetector(stopSigns(1:10,:), layers, options, 'NegativeOverlapRange', [0 0.3]);
```

Get the trained network layers from the detector. When you pass in an array of network layers to `trainRCNNObjectDetector`, they are used as-is to continue training.

```
network = rcnn.Network;
layers = network.Layers;
```

Resume training using all the training data.

```
rcnnFinal = trainRCNNObjectDetector(stopSigns, layers, options);
```

Create a network for multiclass R-CNN object detection

Create an R-CNN object detector for two object classes: dogs and cats.

```
objectClasses = {'dogs', 'cats'};
```

The network must be able to classify both dogs, cats, and a "background" class in order to be trained using `trainRCNNObjectDetector`. In this example, a one is added to include the background.

```
numClassesPlusBackground = numel(objectClasses) + 1;
```

The final fully connected layer of a network defines the number of classes that the network can classify. Set the final fully connected layer to have an output size equal to the number of classes plus a background class.

```
layers = [ ...
    imageInputLayer([28 28 1])
```



```
convolution2dLayer(5,20)
fullyConnectedLayer(numClassesPlusBackground);
softmaxLayer()
classificationLayer()];
```

These network layers can now be used to train an R-CNN two-class object detector.

Use A Saved Network In R-CNN Object Detector

Create an R-CNN object detector and set it up to use a saved network checkpoint. A network checkpoint is saved every epoch during network training when the `trainingOptions` 'CheckpointPath' parameter is set. Network checkpoints are useful in case your training session terminates unexpectedly.

Load the stop sign training data.

```
load('rcnnStopSigns.mat','stopSigns','layers')
```

Add full path to image files.

```
stopSigns.imageFilename = fullfile(toolboxdir('vision'),'visiondata', ...
    stopSigns.imageFilename);
```

Set the 'CheckpointPath' using the `trainingOptions` function.

```
checkpointLocation = tempdir;
options = trainingOptions('sgdm','Verbose',false, ...
    'CheckpointPath',checkpointLocation);
```

Train the R-CNN object detector with a few images.

```
rcnn = trainRCNNObjectDetector(stopSigns(1:3,:),layers,options);
```

Load a saved network checkpoint.

```
wildcardFilePath = fullfile(checkpointLocation,'convnet_checkpoint_*.mat');
contents = dir(wildcardFilePath);
```

Load one of the checkpoint networks.

```
filepath = fullfile(contents(1).folder,contents(1).name);
checkpoint = load(filepath);
```

```
checkpoint.net
```

```
ans =
```

```
SeriesNetwork with properties:
```

```
Layers: [15x1 nnet.cnn.layer.Layer]
```

Create a new R-CNN object detector and set it up to use the saved network.

```
rcnnCheckPoint = rcnnObjectDetector();  
rcnnCheckPoint.RegionProposalFcn = @rcnnObjectDetector.proposeRegions;
```

Set the Network to the saved network checkpoint.

```
rcnnCheckPoint.Network = checkpoint.net
```

```
rcnnCheckPoint =
```

```
    rcnnObjectDetector with properties:
```

```
        Network: [1x1 SeriesNetwork]  
        ClassNames: {'stopSign' 'Background'}  
        RegionProposalFcn: @rcnnObjectDetector.proposeRegions
```

See Also

Apps

Image Labeler | **Video Labeler**

Functions

SeriesNetwork | **trainNetwork** | **trainRCNNObjectDetector** | **fastRCNNObjectDetector** | **fasterRCNNObjectDetector** | **vision.CascadeObjectDetector** | **selectStrongestBboxMulticlass**

Topics

“Image Category Classification Using Deep Learning”

“Getting Started with R-CNN, Fast R-CNN, and Faster R-CNN”

Introduced in R2016b

bagOfFeatures

Bag of visual words object

Description

You can construct a bag of visual words for use in image category classification, image retrieval, or loop closure detection in visual simultaneous localization and mapping (vSLAM).

Creation

Syntax

```
bag = bagOfFeatures(imds)
bag = bagOfFeatures(imds, 'CustomExtractor', extractorFcn)
bag = bagOfFeatures(imds, Name, Value)
```

Description

`bag = bagOfFeatures(imds)` returns a bag of features object. The `bag` output object is generated using samples from the `imds` input. By default, the visual vocabulary is created from SURF features extracted from images in `imds`.

`bag = bagOfFeatures(imds, 'CustomExtractor', extractorFcn)` returns a bag of features that uses a custom feature extractor function to extract features from images in `imds`. `extractorFcn` is a function handle to a custom feature extraction function.

`bag = bagOfFeatures(imds, Name, Value)` sets properties using one or more name-value pairs. Enclose each property name in quotes. For example, `bag = bagOfFeatures('Verbose', true)`

This object supports parallel computing using multiple MATLAB workers. Enable parallel computing from the “Computer Vision Toolbox Preferences” dialog box. To open Computer Vision Toolbox preferences, on the **Home** tab, in the **Environment** section, click **Preferences**. Then select Computer Vision Toolbox.

Input Arguments

imds — Images

ImageDatastore object

Images, specified as an ImageDatastore object. The `bagOfFeatures` extracts an equal number of strongest features from the images contained in the `imds` object. The number of strongest features is defined as:

$$\text{number of strongest features} = \min(\text{number of features found in each set}) \times \text{StrongestFraction}$$

The object obtains the `StrongestFraction` value from the `StrongestFeatures` property.

extractorFcn — Custom feature extractor function

function handle

Custom feature extractor function, specified as a function handle. This custom function extracts features to learn the visual vocabulary of the object.

The function, `extractorFcn`, must be specified as a function handle for a file:

```
extractorFcn = @exampleBagOfFeaturesExtractor;
bag = bagOfFeatures(imds, 'CustomExtractor', extractorFcn)
```

where `exampleBagOfFeaturesExtractor` is a MATLAB function. For example:

```
function [features, featureMetrics, location] = exampleBagOfFeaturesExtractor(img)
...

```

The function must be on the path or in the current working directory. The arguments are defined as:

Argument	Input/Output	Description
<code>img</code>	Input	<ul style="list-style-type: none"> Binary, grayscale, or truecolor image. The input image is from the image set that was originally passed into <code>bagOfFeatures</code>.
<code>features</code>	Output	<ul style="list-style-type: none"> A <code>binaryFeatures</code> object. An M-by-N numeric matrix of image features, where M is the number of features and N is the length of each feature vector. The feature length, N, must be greater than zero and be the same for all images processed during the <code>bagOfFeatures</code> creation process. If you cannot extract features from an image, supply an empty feature matrix and an empty feature metrics vector. Use the empty matrix and vector if, for example, you did not find any keypoints for feature extraction. Numeric, real, and nonsparse.
<code>featureMetrics</code>	Output	<ul style="list-style-type: none"> An M-by-1 vector of feature metrics indicating the strength of each feature vector. Used to apply the 'SelectStrongest' criteria in <code>bagOfFeatures</code> framework. Numeric, real, and nonsparse.
<code>location</code>	Output	<ul style="list-style-type: none"> An M-by-2 matrix of 1-based $[x\ y]$ values. The $[x\ y]$ values can be fractional. Numeric, real, and nonsparse.

For more details on the custom extractor function and its input and output requirements, see “Create a Custom Feature Extractor”.

You can open an example function file, and use it as a template by typing the following command at the MATLAB command-line:

```
edit('exampleBagOfFeaturesExtractor.m')
```

Properties

CustomExtractor — Custom extraction function

function handle

Custom feature extractor function, specified as a handle to a function. The custom feature extractor function extracts features used to learn the visual vocabulary for `bagOfFeatures`. You must specify 'CustomExtractor' and the function handle, `extractorFcn`, to a custom feature extraction function.

The function, `extractorFcn`, must be specified as a function handle for a file:

```
extractorFcn = @exampleBagOfFeaturesExtractor;
bag = bagOfFeatures(imds, 'CustomExtractor', extractorFcn)
```

where `exampleBagOfFeaturesExtractor` is a MATLAB function such as:

```
function [features, featureMetrics] = exampleBagOfFeaturesExtractor(img)
...

```

The function must be on the path or in the current working directory.

For more details on the custom extractor function and its input and output requirements, see “Create a Custom Feature Extractor”. You can open an example function file, and use it as a template by typing the following command at the MATLAB command-line:

```
edit('exampleBagOfFeaturesExtractor.m')
```

TreeProperties — Vocabulary tree properties

[1 500] (default) | two-element vector

Vocabulary tree properties, specified as a two-element vector in the form [*numLevels* *branchingFactor*]. *numLevels* is an integer that specifies the number of levels in the vocabulary tree. *branchingFactor* is an integer that specifies a factor to control the amount the vocabulary can grow at successive levels in the tree. The maximum number of visual words represented by the vocabulary tree is $branchingFactor^{numLevels}$. Typical values for *numLevels* is between 1 and 6. Typical values for *branchingFactor* is between 10 and 500. Use an empirical analysis to select optimal values.

Increase the branching factor to generate a larger vocabulary. Increasing the vocabulary improves classification and image retrieval accuracy, but will also increase the time to encode images. You can use a vocabulary tree with multiple levels to create vocabularies on the order of 10,000 visual words or more. A multilevel tree reduces the time required to encode images with large vocabularies, but will take longer to create. You can use a tree with one level for vocabularies that contain only 100 - 1000 visual words.

StrongestFeatures — Fraction of strongest features

0.8 (default) | [0, 1]

Fraction of strongest features, specified as the comma-separated pair consisting of 'StrongestFeatures' and a value in the range [0,1]. The value represents the fraction of strongest features to use from each label in the `imds` input.

Verbose — Enable progress display to screen

true (default) | false

Enable progress display to screen, specified as the comma-separated pair consisting of 'Verbose' and the logical `true` or `false`.

PointSelection — Selection method for picking point locations

'Grid' (default) | 'Detector'

Selection method for picking point locations for SURF feature extraction, specified as the comma-separated pair consisting of 'PointSelection' and either 'Grid' or 'Detector'. There are two stages for feature extraction. First, you select a method for picking the point locations, (SURF 'Detector' or 'Grid'), with the `PointSelection` property. The second stage extracts the features. The feature extraction uses a SURF extractor for both point selection methods.

When you set `PointSelection` to 'Detector', the feature points are selected using a speeded up robust feature (SURF) detector. Otherwise, the points are picked on a predefined grid with spacing defined by 'GridStep'. This property applies only when you are not specifying a custom extractor with the `CustomExtractor` property.

GridStep — Grid step size

[8 8] (default) | 1-by-2 [x y] vector

Grid step size in pixels, specified as the comma-separated pair consisting of 'GridStep' and an 1-by-2 [x y] vector. This property applies only when you set `PointSelection` to 'Grid' and you are not specifying a custom extractor with the `CustomExtractor` property. The steps in the x and y directions define the spacing of a uniform grid. Intersections of the grid lines define locations for feature extraction.

BlockWidth — Patch size to extract upright SURF descriptor

[32 64 96 128] (default) | 1-by-N vector

Patch size to extract upright SURF descriptor, specified as the comma-separated pair consisting of 'BlockWidth' and a 1-by-N vector of N block widths. This property applies only when you are not specifying a custom extractor with the `CustomExtractor` property. Each element of the vector corresponds to the size of a square block from which the function extracts upright SURF descriptors. Use multiple square sizes to extract multiscale features. All the square specified are used for each extraction points on the grid. This property only applies when you set `PointSelection` to 'Grid'. The block width corresponds to the scale of the feature. The minimum `BlockWidth` is 32 pixels.

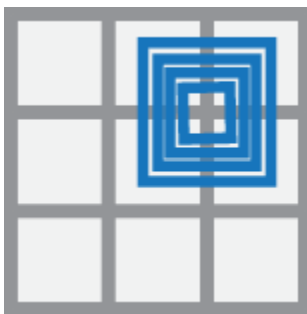

Upright — Orientation of SURF feature vector

`true` (default) | logical scalar

Orientation of SURF feature vector, specified as the comma-separated pair consisting of 'Upright' and a logical scalar. This property applies only when you are not specifying a custom extractor with the `CustomExtractor` property. Set this property to `true` when you do not need to estimate the

orientation of the SURF feature vectors. Set it to `false` when you need the image descriptors to capture rotation information.

Object Functions

`encode` Create histogram of visual word occurrences

Examples

Create a Bag of Visual Words

Load two image sets.

```
setDir = fullfile(toolboxdir('vision'),'visiondata','imageSets');
imgSets = imageSet(setDir,'recursive');
```

Pick the first two images from each image set to create training sets.

```
trainingSets = partition(imgSets,2);
```

Create the bag of features. This process can take a few minutes.

```
bag = bagOfFeatures(trainingSets,'Verbose',false);
```

Compute histogram of visual word occurrences for one of the images. Store the histogram as feature vector.

```
img = read(imgSets(1),1);
featureVector = encode(bag,img);
```

```
Encoding images using Bag-Of-Features.
```

```
-----
```

```
* Encoding an image...done.
```

Create a Bag of Features with a Custom Feature Extractor

Load an image set.

```
setDir = fullfile(toolboxdir('vision'),'visiondata','imageSets');
imds = imageDatastore(setDir,'IncludeSubfolders',true,'LabelSource',...
    'foldernames');
```

Specify a custom feature extractor.

```
extractor = @exampleBagOfFeaturesExtractor;
bag = bagOfFeatures(imds,'CustomExtractor',extractor)
```

```
Creating Bag-Of-Features.
```

```
-----
```

```
* Image category 1: books
```

```
* Image category 2: cups
```

```
* Extracting features using a custom feature extraction function: exampleBagOfFeaturesExtractor.
```

```
* Extracting features from 12 images...done. Extracted 230400 features.
```

```
* Keeping 80 percent of the strongest features from each category.

* Creating a 500 word visual vocabulary.
* Number of levels: 1
* Branching factor: 500
* Number of clustering steps: 1

* [Step 1/1] Clustering vocabulary level 1.
* Number of features      : 184320
* Number of clusters     : 500
* Initializing cluster centers...100.00%.
* Clustering...completed 31/100 iterations (~0.54 seconds/iteration)...converged in 31 iterations

* Finished creating Bag-Of-Features

bag =
  bagOfFeatures with properties:

    CustomExtractor: @exampleBagOfFeaturesExtractor
    NumVisualWords: 500
    TreeProperties: [1 500]
    StrongestFeatures: 0.8000
```

Extended Capabilities

Automatic Parallel Support

Accelerate code by automatically running computation in parallel using Parallel Computing Toolbox™.

To run in parallel, set 'UseParallel' to true or enable this by default using the Computer Vision Toolbox preferences.

For more information, see “Parallel Computing Toolbox Support”.

See Also

[imageDatastore](#) | [imageCategoryClassifier](#) | [trainImageCategoryClassifier](#)

Topics

“Monocular Visual Simultaneous Localization and Mapping”

“Image Category Classification Using Bag of Features”

“Image Classification with Bag of Visual Words”

“Create a Custom Feature Extractor”

Introduced in R2014b

encode

Create histogram of visual word occurrences

Syntax

```
featureVector = encode(bag,I)
[featureVector,words] = encode(bag,I)

featureVector= encode(bag,imds)
[featureVector,words] = encode(bag,imds)

[ ___ ] = encode( ___ ,Name,Value)
```

Description

`featureVector = encode(bag,I)` returns a feature vector that represents a histogram of visual word occurrences contained in the input image, `I`. The input `bag` contains the `bagOfFeatures` object.

`[featureVector,words] = encode(bag,I)` optionally returns the visual words as a `visualWords` object. The `visualWords` object stores the visual words that occur in `I` and stores the locations of those words.

`featureVector= encode(bag,imds)` returns a feature vector that represents a histogram of visual word occurrences contained in `imds`. The input `bag` contains the `bagOfFeatures` object.

`[featureVector,words] = encode(bag,imds)` optionally returns an array of `visualWords` occurrences in `imds`. The `visualWords` object stores the visual words that occur in `I` and stores the locations of those words.

`[___] = encode(___ ,Name,Value)` sets properties using one or more name-value pairs. Enclose each property name in quotes. For example, `encode('SparseOutput',false)`

This method supports parallel computing using multiple MATLAB workers. Enable parallel computing from the “Computer Vision Toolbox Preferences” dialog box. To open Computer Vision Toolbox preferences, on the **Home** tab, in the **Environment** section, click **Preferences**. Then select **Computer Vision Toolbox**.

Examples

Encode an Image into a Feature Vector

Load a set of image.

```
setDir = fullfile(toolboxdir('vision'),'visiondata','imageSets');
imds = imageDatastore(setDir,'IncludeSubfolders',true,'LabelSource',...
    'foldernames');
```

Pick the first two images from each label.

```
trainingSet = splitEachLabel(imds,2);
```

Create bag of features.

```
bag = bagOfFeatures(trainingSet);
```

```
Creating Bag-Of-Features.
```

```
-----
```

```
* Image category 1: books
```

```
* Image category 2: cups
```

```
* Selecting feature point locations using the Grid method.
```

```
* Extracting SURF features from the selected feature point locations.
```

```
** The GridStep is [8 8] and the BlockWidth is [32 64 96 128].
```

```
* Extracting features from 4 images...done. Extracted 76800 features.
```

```
* Keeping 80 percent of the strongest features from each category.
```

```
* Creating a 500 word visual vocabulary.
```

```
* Number of levels: 1
```

```
* Branching factor: 500
```

```
* Number of clustering steps: 1
```

```
* [Step 1/1] Clustering vocabulary level 1.
```

```
* Number of features      : 61440
```

```
* Number of clusters      : 500
```

```
* Initializing cluster centers...100.00%.
```

```
* Clustering...completed 24/100 iterations (~0.29 seconds/iteration)...converged in 24 iterations
```

```
* Finished creating Bag-Of-Features
```

Encode one of the images into a feature vector.

```
img = readimage(trainingSet,1);
```

```
featureVector = encode(bag,img);
```

```
Encoding images using Bag-Of-Features.
```

```
-----
```

```
* Encoding an image...done.
```

Input Arguments

bag — Bag of features

bagOfFeatures object

Bag of features, specified as a bagOfFeatures object.

I — Input image

grayscale image | truecolor image

Input image, I, specified as a grayscale or truecolor image.

imds — Images

ImageDatastore object

Images, specified as an ImageDatastore object.

Name-Value Pair Arguments

Example: 'SparseOutput',false

Normalization — Type of normalization

'L2' (default) | 'none'

Type of normalization applied to the feature vector, specified as the comma-separated pair consisting of 'Normalization' and either 'L2' or 'none'.

SparseOutput — Output sparsity

false (default) | true

Output sparsity, specified as the comma-separated pair consisting of 'SparseOutput' and as true or false. Set this property to true to return the visual word histograms in a sparse matrix. Setting this property to true reduces memory consumption for large visual vocabularies where the visual word histograms contain many zero elements.

Verbose — Enable progress display to screen

true (default) | false

Enable progress display to screen, specified as the comma-separated pair consisting of 'Verbose' and the logical true or false.

Output Arguments

featureVector — Histogram of visual word occurrences

1-by-bag.VocabularySize | M-by-bag.VocabularySize

Histogram of visual word occurrences, specified as M-by-bag.VocabularySize vector, where M is the total number of images in imds, numel(imds.Files).

words — Visual words object

visualWords object

Visual words object, returned as a visual words object or an array of visual words objects. The visualWords object stores the visual words that occur in the images and stores the locations of those words.

Extended Capabilities

Automatic Parallel Support

Accelerate code by automatically running computation in parallel using Parallel Computing Toolbox™.

To run in parallel, set 'UseParallel' to true or enable this by default using the Computer Vision Toolbox preferences.

For more information, see “Parallel Computing Toolbox Support”.

See Also

bagOfFeatures

Introduced in R2014b

imageCategoryClassifier

Predict image category

Description

The `imageCategoryClassifier` object contains a linear support vector machine (SVM) classifier trained to recognize an image category.

You must have a Statistics and Machine Learning Toolbox license to use this classifier. This classifier supports parallel computing using multiple MATLAB workers. Enable parallel computing using the “Computer Vision Toolbox Preferences” dialog. To open the Computer Vision Toolbox preferences, on the **Home** tab, in the **Environment** section, click **Preferences**. Select **Computer Vision System Toolbox**.

Creation

Use the `trainImageCategoryClassifier` function to create the `imageCategoryClassifier` object.

```
bag = bagOfFeatures(trainingSet);  
categoryClassifier = trainImageCategoryClassifier(trainingSet,bag);
```

Properties

Labels — Category labels

cell array

Category labels, specified as a cell array.

NumCategories — Number of trained categories

integer

Number of trained categories, stored as an integer value.

Object Functions

`evaluate` Evaluate image classifier on collection of image sets
`predict` Predict image category

Examples

Train, Evaluate, and Apply Image Category Classifier

Load two image categories.

```
setDir = fullfile(toolboxdir('vision'),'visiondata','imageSets');  
imds = imageDatastore(setDir,'IncludeSubfolders',true,'LabelSource',...  
    'foldernames');
```

Split the data set into a training and test data. Pick 30% of images from each set for the training data and the remainder 70% for the test data.

```
[trainingSet,testSet] = splitEachLabel(imds,0.3,'randomize');
```

Create bag of visual words.

```
bag = bagOfFeatures(trainingSet);
```

```
Creating Bag-Of-Features.
```

```
-----  
* Image category 1: books  
* Image category 2: cups  
* Selecting feature point locations using the Grid method.  
* Extracting SURF features from the selected feature point locations.  
** The GridStep is [8 8] and the BlockWidth is [32 64 96 128].  
  
* Extracting features from 4 images...done. Extracted 76800 features.  
  
* Keeping 80 percent of the strongest features from each category.  
  
* Creating a 500 word visual vocabulary.  
* Number of levels: 1  
* Branching factor: 500  
* Number of clustering steps: 1  
  
* [Step 1/1] Clustering vocabulary level 1.  
* Number of features      : 61440  
* Number of clusters      : 500  
* Initializing cluster centers...100.00%.  
* Clustering...completed 20/100 iterations (~0.18 seconds/iteration)...converged in 20 iterations.  
  
* Finished creating Bag-Of-Features
```

Train a classifier with the training sets.

```
categoryClassifier = trainImageCategoryClassifier(trainingSet,bag);
```

```
Training an image category classifier for 2 categories.
```

```
-----  
* Category 1: books  
* Category 2: cups  
  
* Encoding features for 4 images...done.  
  
* Finished training the category classifier. Use evaluate to test the classifier on a test set.
```

Evaluate the classifier using test images. Display the confusion matrix.

```
confMatrix = evaluate(categoryClassifier,testSet)
```

```
Evaluating image category classifier for 2 categories.
```

```
-----  
* Category 1: books  
* Category 2: cups  
  
* Evaluating 8 images...done.
```

```
* Finished evaluating all the test sets.
* The confusion matrix for this test set is:
```

```

          PREDICTED
KNOWN   | books  cups
-----|-----
books   | 0.75  0.25
cups    | 0.25  0.75

```

```
* Average Accuracy is 0.75.
```

```
confMatrix = 2x2
```

```

    0.7500    0.2500
    0.2500    0.7500

```

Find the average accuracy of the classification.

```
mean(diag(confMatrix))
```

```
ans = 0.7500
```

Apply the newly trained classifier to categorize new images.

```
img = imread(fullfile(setDir,'cups','bigMug.jpg'));
[labelIdx, score] = predict(categoryClassifier,img);
```

```
Encoding images using Bag-Of-Features.
```

```
-----
* Encoding an image...done.
```

Display the classification label.

```
categoryClassifier.Labels(labelIdx)
```

```
ans = 1x1 cell array
    {'cups'}
```

References

[1] Csurka, G., C. R. Dance, L. Fan, J. Willamowski, and C. Bray *Visual Categorization with Bag of Keypoints*, Workshop on Statistical Learning in Computer Vision, ECCV 1 (1-22), 1-2.

Extended Capabilities

Automatic Parallel Support

Accelerate code by automatically running computation in parallel using Parallel Computing Toolbox™.

To run in parallel, set 'UseParallel' to true or enable this by default using the Computer Vision Toolbox preferences.

For more information, see “Parallel Computing Toolbox Support”.

See Also

imageDatastore | bagOfFeatures | trainImageCategoryClassifier | fitcecoc

Topics

“Image Category Classification Using Bag of Features”

“Image Classification with Bag of Visual Words”

Introduced in R2014b

predict

Predict image category

Syntax

```
[labelIdx,score] = predict(categoryClassifier,I)
[labelIdx,score] = predict(categoryClassifier,imds)
[labelIdx,score] = predict( ___, 'Verbose',true)
```

Description

`[labelIdx,score] = predict(categoryClassifier,I)` returns the predicted label index and score for the input image.

`predict` supports parallel computing using multiple MATLAB workers. Enable parallel computing using the “Computer Vision Toolbox Preferences” dialog. To open Computer Vision Toolbox preferences, on the **Home** tab, in the **Environment** section, click **Preferences**. Select Computer Vision Toolbox.

`[labelIdx,score] = predict(categoryClassifier,imds)` returns the predicted label index and score for the images specified in `imds`.

`[labelIdx,score] = predict(___, 'Verbose',true)` also enables progress display to the screen. Set to `false` to turn it off.

Examples

Predict Category for Image

Load two image category sets.

```
setDir = fullfile(toolboxdir('vision'),'visiondata','imageSets');
imds = imageDatastore(setDir,'IncludeSubfolders',true,'LabelSource',...
    'folderNames');
```

Separate the two sets into training and test data. Pick 30% of images from each set for the training data and the remainder 70% for the test data.

```
[trainingSet,testSet] = splitEachLabel(imds,0.3,'randomize');
```

Create a bag of visual words.

```
bag = bagOfFeatures(trainingSet);
```

Creating Bag-Of-Features.

```
-----
* Image category 1: books
* Image category 2: cups
* Selecting feature point locations using the Grid method.
* Extracting SURF features from the selected feature point locations.
```

```
** The GridStep is [8 8] and the BlockWidth is [32 64 96 128].
* Extracting features from 4 images...done. Extracted 76800 features.
* Keeping 80 percent of the strongest features from each category.
* Creating a 500 word visual vocabulary.
* Number of levels: 1
* Branching factor: 500
* Number of clustering steps: 1

* [Step 1/1] Clustering vocabulary level 1.
* Number of features      : 61440
* Number of clusters     : 500
* Initializing cluster centers...100.00%.
* Clustering...completed 20/100 iterations (~0.27 seconds/iteration)...converged in 20 iterations

* Finished creating Bag-Of-Features
```

Train a classifier.

```
categoryClassifier = trainImageCategoryClassifier(trainingSet,bag);
```

Training an image category classifier for 2 categories.

```
-----
* Category 1: books
* Category 2: cups

* Encoding features for 4 images...done.

* Finished training the category classifier. Use evaluate to test the classifier on a test set.
```

Predict category label for one of the images in test set.

```
img = readimage(testSet,1);
[labelIdx, score] = predict(categoryClassifier,img);
```

Encoding images using Bag-Of-Features.

```
-----
* Encoding an image...done.
```

```
categoryClassifier.Labels(labelIdx)
```

```
ans = 1x1 cell array
    {'books'}
```

Input Arguments

I — Input image

M-by-*N*-by-3 truecolor image | *M*-by-*N* 2-D grayscale image

Input image, specified as either an *M*-by-*N*-by-3 truecolor image or an *M*-by-*N* 2-D grayscale image.

categoryClassifier — Image category classifier

imageCategoryClassifier object

Image category classifier, specified as an `imageCategoryClassifier` object.

imds — Images

`ImageDatastore` object

Images, specified as an `ImageDatastore` object.

Output Arguments

labelIdx — Predicted label index

M -by-1 vector | scalar

Predicted label index, returned as either an M -by-1 vector for M images or a scalar value for a single image. The `labelIdx` output value corresponds to the index of an image set used to train the bag of features. The prediction index corresponds to the class with the lowest average binary loss of the ECOC SVM classifier.

score — Prediction score

1-by- N vector | M -by- N matrix

Prediction score, specified as a 1-by- N vector or an M -by- N matrix. N represents the number of classes. M represents the number of images in the `imgSet` input object, `imgSet`. The score provides a negated average binary loss per class. Each class is a support vector machine (SVM) multiclass classifier that uses the error-correcting output codes (ECOC) approach.

Extended Capabilities

Automatic Parallel Support

Accelerate code by automatically running computation in parallel using Parallel Computing Toolbox™.

To run in parallel, set 'UseParallel' to true or enable this by default using the Computer Vision Toolbox preferences.

For more information, see “Parallel Computing Toolbox Support”.

See Also

`imageCategoryClassifier` | `evaluate`

Introduced in R2014b

evaluate

Evaluate image classifier on collection of image sets

Syntax

```
confMat = evaluate(categoryClassifier,imds)
[confMat,knownLabelIdx,predictedLabelIdx,score] = evaluate(
categoryClassifier,imds)
```

Description

`confMat = evaluate(categoryClassifier,imds)` returns a normalized confusion matrix, `confMat`.

`[confMat,knownLabelIdx,predictedLabelIdx,score] = evaluate(categoryClassifier,imds)` additionally returns the corresponding label indexes and score.

Examples

Train, Evaluate, and Apply Image Category Classifier

Load two image categories.

```
setDir = fullfile(toolboxdir('vision'),'visiondata','imageSets');
imds = imageDatastore(setDir,'IncludeSubfolders',true,'LabelSource',...
'foldernames');
```

Split the data set into a training and test data. Pick 30% of images from each set for the training data and the remainder 70% for the test data.

```
[trainingSet,testSet] = splitEachLabel(imds,0.3,'randomize');
```

Create bag of visual words.

```
bag = bagOfFeatures(trainingSet);
```

```
Creating Bag-Of-Features.
```

```
-----
* Image category 1: books
* Image category 2: cups
* Selecting feature point locations using the Grid method.
* Extracting SURF features from the selected feature point locations.
** The GridStep is [8 8] and the BlockWidth is [32 64 96 128].

* Extracting features from 4 images...done. Extracted 76800 features.

* Keeping 80 percent of the strongest features from each category.

* Creating a 500 word visual vocabulary.
* Number of levels: 1
* Branching factor: 500
```

```

* Number of clustering steps: 1
* [Step 1/1] Clustering vocabulary level 1.
* Number of features      : 61440
* Number of clusters     : 500
* Initializing cluster centers...100.00%.
* Clustering...completed 20/100 iterations (~0.18 seconds/iteration)...converged in 20 iterations.

* Finished creating Bag-Of-Features

```

Train a classifier with the training sets.

```
categoryClassifier = trainImageCategoryClassifier(trainingSet,bag);
```

```
Training an image category classifier for 2 categories.
-----
```

```

* Category 1: books
* Category 2: cups

* Encoding features for 4 images...done.

* Finished training the category classifier. Use evaluate to test the classifier on a test set.

```

Evaluate the classifier using test images. Display the confusion matrix.

```
confMatrix = evaluate(categoryClassifier,testSet)
```

```
Evaluating image category classifier for 2 categories.
-----
```

```

* Category 1: books
* Category 2: cups

* Evaluating 8 images...done.

* Finished evaluating all the test sets.

* The confusion matrix for this test set is:

```

KNOWN	PREDICTED	
	books	cups
books	0.75	0.25
cups	0.25	0.75

```
* Average Accuracy is 0.75.
```

```
confMatrix = 2x2
```

```

    0.7500    0.2500
    0.2500    0.7500

```

Find the average accuracy of the classification.

```
mean(diag(confMatrix))
```

```
ans = 0.7500
```

Apply the newly trained classifier to categorize new images.

```
img = imread(fullfile(setDir,'cups','bigMug.jpg'));  
[labelIdx, score] = predict(categoryClassifier,img);
```

```
Encoding images using Bag-Of-Features.  
-----
```

```
* Encoding an image...done.
```

Display the classification label.

```
categoryClassifier.Labels(labelIdx)
```

```
ans = 1x1 cell array  
      {'cups'}
```

Input Arguments

imds — Data store object of images

ImageDatastore object

Images, specified in an ImageDatastore object.

categoryClassifier — Image category classifier

imageCategoryClassifier object

Image category classifier, specified as an imageCategoryClassifier object.

Output Arguments

confMat — Confusion matrix

matrix

Confusion matrix, returned as a matrix. The row indices correspond to known labels and the columns correspond to the predicted labels.

knownLabelIdx — Label index for image set

M -by-1 vector | scalar

Label index for image set, returned as an M -by-1 vector for M images. The knownLabelIdx output value corresponds to the index of an image set used to train the bag of features.

predictedLabelIdx — Predicted label index

M -by-1 vector

Predicted label index, returned as an M -by-1 vector for M images. The predictedLabelIdx output value corresponds to the index of an image set used to train the bag of features. The predicted index corresponds to the class with the largest value in the score output.

score — Prediction score

M -by- N matrix

Prediction score, specified as an M -by- N matrix. N represents the number of classes. M represents the number of images in the imageSet input object, imgSet. The score provides a negated average

binary loss per class. Each class is a support vector machine (SVM) multiclass classifier that uses the error-correcting output codes (ECOC) approach.

See Also

`imageCategoryClassifier` | `predict`

Introduced in R2014b

intrinsicsEstimationErrors

Object for storing standard errors of estimated camera intrinsics and distortion coefficients

Description

The `intrinsicsEstimationErrors` object contains the standard errors of estimated camera intrinsics and distortion coefficients. You can access the intrinsics and distortion standard errors using the object properties. You can display the standard errors using the `displayErrors` object function.

Creation

Syntax

```
[params,imgsUsed,Errors] = estimateCameraParameters(imagePoints,worldPoints)
```

Description

`[params,imgsUsed,Errors] = estimateCameraParameters(imagePoints,worldPoints)` creates an `intrinsicsEstimationErrors` object by calling the `estimateCameraParameters` function with image points and world points. The function returns a `stereoCalibrationErrors` or `cameraCalibrationErrors` object as the third output argument, which contains the `intrinsicsEstimationErrors` as a read-only property.

Properties

SkewError — Standard error of camera axes skew estimate

scalar

This property is read-only.

Standard error of the camera axes skew estimate, specified as a scalar.

FocalLengthError — Standard error of focal length estimate

scalar

Standard error of the focal length estimate, specified as a scalar.

PrincipalPointError — Standard error of principal point estimate

scalar

This property is read-only.

Standard error of the principal point estimate, specified as a scalar.

RadialDistortionError — Standard error of radial distortion estimate

scalar

This property is read-only.

Standard error of the radial distortion estimate, specified as a scalar.

TangentialDistortionError — Standard error of tangential distortion estimate

scalar

This property is read-only.

Standard error of the tangential distortion estimate, specified as a scalar.

Examples

Display Intrinsic Errors

Create a set of calibration images.

```
images = imageDatastore(fullfile(toolboxdir("vision"), "visiondata", ...
    "calibration", "mono"));
```

Detect the calibration pattern.

```
[imagePoints, boardSize] = detectCheckerboardPoints(images.Files);
```

Generate the world coordinates of the corners of the squares. The units of the square are in millimeters.

```
squareSize = 29;
worldPoints = generateCheckerboardPoints(boardSize, squareSize);
```

Calibrate the camera.

```
I = readimage(images, 1);
imageSize = [size(I, 1) size(I, 2)];
[params, ~, errors] = estimateCameraParameters(imagePoints, worldPoints, ...
    ImageSize=imageSize);
```

Display the standard intrinsic errors.

```
displayErrors(errors.IntrinsicErrors, params);
```

```
Focal length (pixels): [ 714.1886 +/- 3.3219      710.3785 +/- 4.0579 ]
Principal point (pixels): [ 563.6481 +/- 5.3967      355.7252 +/- 3.3036 ]
Radial distortion: [ -0.3536 +/- 0.0091      0.1730 +/- 0.0488 ]
```

See Also

Apps

[Camera Calibrator](#) | [Stereo Camera Calibrator](#)

Objects

[cameraCalibrationErrors](#) | [stereoCalibrationErrors](#) | [extrinsicsEstimationErrors](#)

Topics

[“Using the Single Camera Calibrator App”](#)

“Using the Stereo Camera Calibrator App”
“Evaluating the Accuracy of Single Camera Calibration”

Introduced in R2013b

extrinsicsEstimationErrors

Object for storing standard errors of estimated camera intrinsics and distortion coefficients

Description

The `extrinsicsEstimationErrors` object contains the standard errors of estimated camera extrinsics. You can access the extrinsics standard errors using the object properties. You can display the standard errors using the `displayErrors` object function.

Creation

Syntax

```
[params,imgsUsed,Errors] = estimateCameraParameters(imagePoints,worldPoints)
```

Description

`[params,imgsUsed,Errors] = estimateCameraParameters(imagePoints,worldPoints)` creates an `extrinsicsEstimationErrors` object by calling the `estimateCameraParameters` function with image points and world points. The function returns a `stereoCalibrationErrors` or `cameraCalibrationErrors` object as the third argument, which contains the `extrinsicsEstimationErrors` as a read-only property.

Properties

RotationVectorsError — Standard error of the camera rotations estimate

scalar

This property is read-only.

Standard error of the camera rotations estimate, specified as a scalar.

TranslationVectorsError — Standard error of the camera translations estimate

scalar

Standard error of the camera translations estimate, specified as a scalar.

Examples

Display Extrinsic Errors

Create a set of calibration images.

```
images = imageDatastore(fullfile(toolboxdir("vision"),"visiondata", ...  
    "calibration","mono"));
```

Detect the calibration pattern.

```
[imagePoints,boardSize] = detectCheckerboardPoints(images.Files);
```

Generate the world coordinates of the corners of the squares. The units of the square are in millimeters.

```
squareSize = 29;
worldPoints = generateCheckerboardPoints(boardSize,squareSize);
```

Calibrate the camera.

```
I = readimage(images,1);
imageSize = [size(I,1),size(I,2)];
[params,~,errors] = estimateCameraParameters(imagePoints,worldPoints, ...
                                             ImageSize=imageSize);
```

Display the standard extrinsics errors.

```
displayErrors(errors.ExtrinsicsErrors,params);
```

Rotation vectors:

[-0.6096 +/- 0.0054	-0.1789 +/- 0.0073	-0.3835 +/- 0.002
[-0.7283 +/- 0.0050	-0.0996 +/- 0.0072	0.1964 +/- 0.002
[-0.6722 +/- 0.0051	-0.1444 +/- 0.0074	-0.1329 +/- 0.002
[-0.5836 +/- 0.0056	-0.2901 +/- 0.0074	-0.5622 +/- 0.002
[-0.3157 +/- 0.0065	-0.1441 +/- 0.0075	-0.1067 +/- 0.001
[-0.7581 +/- 0.0052	0.1947 +/- 0.0072	0.4324 +/- 0.003
[-0.7515 +/- 0.0051	0.0767 +/- 0.0072	0.2070 +/- 0.002
[-0.6223 +/- 0.0053	0.0231 +/- 0.0073	0.3663 +/- 0.002
[0.3443 +/- 0.0063	-0.2226 +/- 0.0073	-0.0437 +/- 0.001

Translation vectors (mm):

[-146.0517 +/- 6.0391	-26.8685 +/- 3.7318	797.9026 +/- 3.900
[-209.4358 +/- 6.9637	-59.4565 +/- 4.3578	921.8198 +/- 4.629
[-129.3825 +/- 7.0907	-44.1030 +/- 4.3751	937.6831 +/- 4.491
[-151.0049 +/- 6.6905	-27.3253 +/- 4.1339	884.2788 +/- 4.392
[-174.9500 +/- 6.7056	-24.3499 +/- 4.1606	886.4961 +/- 4.668
[-134.3097 +/- 7.8887	-103.4981 +/- 4.8925	1042.4553 +/- 4.818
[-173.9846 +/- 7.6891	-73.1691 +/- 4.7812	1017.2385 +/- 4.812
[-202.9448 +/- 7.4327	-87.9091 +/- 4.6482	983.6957 +/- 4.907
[-319.8862 +/- 6.3213	-119.8898 +/- 4.0922	829.4581 +/- 4.959

See Also

Apps

[Camera Calibrator](#) | [Stereo Camera Calibrator](#)

Objects

[cameraCalibrationErrors](#) | [stereoCalibrationErrors](#) | [intrinsicsEstimationErrors](#)

Functions

[estimateCameraParameters](#)

Topics

["Using the Single Camera Calibrator App"](#)

["Using the Stereo Camera Calibrator App"](#)

["Evaluating the Accuracy of Single Camera Calibration"](#)

Introduced in R2013b

BRISKPoints

Object for storing BRISK interest points

Description

This object provides the ability to pass data between the `detectBRISKFeatures` and `extractFeatures` functions. You can also use it to manipulate and plot the data returned by these functions. You can use the object to fill the points interactively in situations where you might want to mix a non-BRISK interest point detector with a BRISK descriptor.

Creation

Syntax

```
points = BRISKPoints(Location)
points = BRISKPoints(Location,Name,Value)
```

Description

`points = BRISKPoints(Location)` constructs a `BRISKPoints` object from an M -by-2 array of [x y] point coordinates, `Location`.

`points = BRISKPoints(Location,Name,Value)` sets properties using one or more name-value pairs. Enclose each property name in quotes. For example, `points = BRISKPoints('Metric',0.0)`

Input Arguments

Location — Point locations

M -by-2 array (default)

Point locations, specified as an M -by-2 array of [x y] point coordinates.

Properties

Count — Number of points

0 (default) | integer

Number of points held by the BRISK object, specified as a numeric value.

Location — Point locations

M -by-2 array (default)

Point locations, specified as an M -by-2 array of [x y] point coordinates.

Scale — Scale

12.0 (default) | scalar

Scale at which the feature is detected, specified as a value greater than or equal to 1.6.

Metric — Strength of detected feature

0.0 (default) | numeric scalar

Strength of detected feature, specified as a numeric value. The BRISK algorithm uses a determinant of an approximated Hessian.

Orientation — Orientation

0.0 (default) | angle in radians

Orientation of the detected feature, specified as an angle, in radians. The angle is measured counterclockwise from the X-axis with the origin specified by the `Location` property. Do not set this property manually. Use the call to `extractFeatures` to fill in this value. The `extractFeatures` function modifies the default value of 0.0. Using BRISK interest points to extract a non-BRISK descriptor, (e.g. SURF, FREAK, MSER, etc.), can alter `Orientation` values. The `Orientation` is mainly useful for visualization purposes.

Object Functions

<code>plot</code>	Plot points
<code>isempty</code>	Determine if points object is empty
<code>length</code>	Number of stored points
<code>selectStrongest</code>	Select points with strongest metrics
<code>size</code>	Return size of points object
<code>selectUniform</code>	Select uniformly distributed subset of feature points

Examples

Detect BRISK Features in an Image

Read an image and detect the BRISK interest points.

```
I = imread('cameraman.tif');
points = detectBRISKFeatures(I);
location = [100:228;100:228]';
points = BRISKPoints(location);
```

Select and plot the 10 strongest interest points.

```
strongest = points.selectStrongest(10);
imshow(I); hold on;
plot(strongest);
```



Display the [x y] coordinates.

```
strongest.Location
ans = 10x2 single matrix

100 100
101 101
102 102
103 103
104 104
105 105
106 106
107 107
108 108
109 109
```

Tips

Although `BRISKPoints` can hold many points, it is a scalar object. Therefore, `numel(BRISKPoints)` always returns 1. This value can differ from `length(BRISKPoints)`, which returns the true number of points held by the object.

References

- [1] Leutenegger, S., M. Chli, and R. Siegwart. *BRISK: Binary Robust Invariant Scalable Keypoints*, Proceedings of the IEEE International Conference on Computer Vision (ICCV) 2011.

Extended Capabilities

C/C++ Code Generation

Generate C and C++ code using MATLAB® Coder™.

Usage notes and limitations:

- To index locations with this object, use the syntax: `points.Location(idx,:)`, for `points` object. See `visionRecoverFromCodeGeneration_kernel.m`, which is used in the “Introduction to Code Generation with Feature Matching and Registration” example.

See Also

`detectBRISKFeatures` | `detectMSERFeatures` | `detectFASTFeatures` | `detectMinEigenFeatures` | `detectHarrisFeatures` | `extractFeatures` | `matchFeatures` | `detectSURFFeatures` | `MSERRegions` | `SURFPoints` | `cornerPoints` | `KAZEPoints` | `detectORBFeatures` | `ORBPoints`

Introduced in R2014a

imageSet

(Not recommended) Define collection of images

Note The `imageSet` object is not recommended. Instead, manage collections of image data using an `imageDatastore` object. For more information, see “Compatibility Considerations”.

Description

An `imageSet` object stores information about an image data set or a collection of image data sets. You can use this object to manage your image data. The object contains image descriptions, locations of images, and the number of images in your collection.

Creation

Syntax

```
imgSet = imageSet(imageLocation)
imgSetVector = imageSet(imgFolder,'recursive')
```

Description

`imgSet = imageSet(imageLocation)` creates an `imageSet` object.

`imgSetVector = imageSet(imgFolder,'recursive')` returns a vector of image sets found through a recursive search starting from `imgFolder`. The `imgSetVector` output is a 1-by-*NumFolders* vector of `imageSet` objects, where *NumFolders* is the number of folders that contain at least one image.

Input Arguments

imageLocation — Image file location

character vector | cell array

Image file location, specified as a character vector or a cell array. The vector must specify the folder name that contains the images. The image files name extensions must be supported by `imread`. The cell array must contain image locations.

Example: `{'imagePath1','imagePath2', ..., 'imagePathX'}`, where each *imagePath* represents the path to an image.

imgFolder — Start recursive image search folder

character vector

Start recursive image search folder, specified as a character vector. The function searches the folder structure recursively, starting from `imgFolder`.

Properties

Description — Information about image set

character vector

Information about the image set, specified as a character vector. When you create an image set by recursively searching folders or by specifying a single folder location, the `Description` property is set to the folder name. When you specify individual image files, the `Description` property is not set. You can set the property manually.

Data Types: `char`

Count — Number of images in image set

positive integer

Number of images in the image set, specified as a positive integer.

Data Types: `double` | `single`

ImageLocation — Image locations

cell array of character vectors

Image locations, specified as a cell array of character vectors.

Data Types: `cell`

Object Functions

`partition` (Not recommended) Divide image set into subsets
`read` (Not recommended) Read image at specified index
`select` (Not recommended) Select subset of images from image set

Examples

Create an Image Set From a Folder of Images

Read the folder of images.

```
imgFolder = fullfile(toolboxdir('vision'),'visiondata','stopSignImages');  
imgSet = imageSet(imgFolder);
```

Display the first image in the image set collection.

```
imshow(read(imgSet,1));
```



Create an Array of Image Sets from Multiple Folders

Identify the path to the image sets.

```
imgFolder = fullfile(matlabroot, 'toolbox', 'vision', ...  
    'visiondata', 'imageSets');
```

Recursively scan the entire image set folder.

```
imgSets = imageSet(imgFolder, 'recursive')
```

```
imgSets=1x2 object  
1x2 imageSet array with properties:
```

```
    Description  
    ImageLocation  
    Count
```

Display the names of the scanned folders.

```
{imgSets.Description}
```

```
ans = 1x2 cell  
    {'books'}    {'cups'}
```

Display 2nd image from the 'cups' folder.

```
imshow(read(imgSets(2),2));
```



Create an Image Set by Specifying Individual Images

Specify individual images.

As an alternative to the method below, you can pick the files manually using `imggetFile`: `imgFiles = imggetFile('MultiSelect',true);`

```
imgFiles = { fullfile(matlabroot,'toolbox','vision','visiondata','stopSignImages','image001.jpg')
             fullfile(matlabroot,'toolbox','vision','visiondata','stopSignImages','image002.jpg') }
```

Create image set.

```
imgSet = imageSet(imgFiles);
```

Compatibility Considerations

imageSet is not recommended

Not recommended starting in R2016b

`imageSet` is not recommended. Use `imageDatastore` instead, which offers more functionality. There are no plans to remove `imageSet`.

See Also

[imggetFile](#) | [imageCategoryClassifier](#) | [bagOfFeatures](#) | [trainImageCategoryClassifier](#)

Topics

“Image Category Classification Using Bag of Features”

Introduced in R2014b

partition

(Not recommended) Divide image set into subsets

Note The `partition` function of the `imageSet` object is not recommended. Instead, use the `imageDatastore` object and its `partition` function. For more information, see “Compatibility Considerations”.

Syntax

```
[set1,set2,...,setN] = partition(imgSet,groupSizes)
[set1,set2,...,setN] = partition(imgSet,groupPercentages)
[set1,set2,...,setN] = partition( ___,method)
```

Description

`[set1,set2,...,setN] = partition(imgSet,groupSizes)` partitions the input image set, `imgSet`, into subsets of size `groupSizes`.

`[set1,set2,...,setN] = partition(imgSet,groupPercentages)` partitions the input image set, `imgSet`, in terms of percentages.

`[set1,set2,...,setN] = partition(___,method)` additionally specifies a method, 'sequential' or 'randomized'.

Examples

Partition Image Set

Create an image set.

```
imgFolder = fullfile(matlabroot,'toolbox','vision','visiondata','stopSignImages');
imgSet = imageSet(imgFolder);
```

Divide the set into two groups: one with five images and the other with the remainder of the images from `imgSet`.

```
[setA1, setA2] = partition(imgSet,5);
```

Randomly partition the set into three groups: one with 20% of the images, the second group with 30%, and the third group with 50%.

```
[setB1, setB2, setB3] = partition(imgSet, [0.2, 0.3], 'randomized');
```

Input Arguments

`imgSet` — Image set

scalar `imageSet` object | array of `imageSet` objects

Image set, specified as a scalar `imageSet` object or an array of `imageSet` objects.

groupSizes — Group size

positive integer | vector of positive integers

Group size of images, specified as a positive integer or vector of positive integers. The number of output arguments must be between 1 and `length(groupSizes) + 1`.

Example: `[20 60]` returns 20 images in `set1`, 60 images in `set2`, and any remaining images in `set3`.

groupPercentages — Group size percentage

scalar

Group size of images by percentage.

Example: `[0.1 0.5]` returns 10% of images in `set1`, 50% in `set2`, and the remainder in `set3`.

method — Image selection method

'sequential' (default) | 'randomized'

Image selection method, specified as either `method` or `'randomized'`. When you set `method` to `'randomized'` the images are randomly selected to form the new sets. When you set `method` to `'sequential'` the images are selected sequentially.

Output Arguments**set1, set2, . . . , setN — Partitioned image sets**array of `imageSet` objects

Partitioned image sets, returned as an array of `imageSet` objects.

Compatibility Considerations**partition is not recommended***Not recommended starting in R2016b*

The `imageSet` object and its `partition` function are not recommended. Instead, manage collections of image data using an `imageDatastore` object, and partition data in the image datastore using the `partition` function. There are no plans to remove the `partition` function of the `imageSet` object.

See Also`imageDatastore` | `partition`**Introduced in R2014b**

read

(Not recommended) Read image at specified index

Note The `read` function of the `imageSet` object is not recommended. Instead, use an `imageDatastore` object and its `read` and `readimage` functions. For more information, see “Compatibility Considerations”.

Syntax

```
im = read(imgSet,idx)
```

Description

`im = read(imgSet,idx)` returns an image from the image set, `imgSet`, located at the index `idx`.

Examples

Display Image from an Image Set

Create an image set.

```
imgFolder = fullfile(matlabroot,'toolbox','vision','visiondata','stopSignImages');  
imgSet = imageSet(imgFolder);
```

Display the fourth image from the set.

```
imshow(read(imgSet, 4));
```



Input Arguments

imgSet — Image set

imageSet object

Image set, specified as an imageSet object.

idx — Image location index

positive integer

Image location index, specified as a positive integer.

Output Arguments

im — Image

numeric array

Image, returned as a numeric array.

Compatibility Considerations

read is not recommended

Not recommended starting in R2016b

The imageSet object and its read function are not recommended. Instead, manage collections of image data using an imageDatastore object, and read images from the image datastore using the

read and readimage functions. There are no plans to remove the read function of the imageSet object.

See Also

imageDatastore | read | readimage

Introduced in R2014b

select

(Not recommended) Select subset of images from image set

Note The `select` function of the `imageSet` object is not recommended. Instead, use an `imageDatastore` object and its `subset` function. For more information, see “Compatibility Considerations”.

Syntax

```
imgSetOut = select(imgSet,idx)
```

Description

`imgSetOut = select(imgSet,idx)` returns a subset of image set, `imgSet`, using the selection of images specified by the index `idx`.

Examples

Select Images Specified by an Index

Read images from a folder.

```
imgFolder = fullfile(matlabroot,'toolbox','vision','visiondata','stopSignImages');  
imgSet = imageSet(imgFolder);
```

Select images 2 and 4 from the image set.

```
imgSetOut = select(imgSet, [2, 4]);
```

Select every other image from the image set.

```
imgSetOut2 = select(imgSet, 1:2:imgSet.Count);
```

Input Arguments

imgSet — Image set

`imageSet` object

Image set, specified as an `imageSet` object.

idx — Image location index

scalar | vector of linear indices | vector of logical indices

Image location index, specified as a scalar, vector of linear indices, or a vector of logical indices. The function uses the `idx` index to select the subset of images.

Output Arguments

imgSetOut — Subset of input image set

imageSet object

Subset of the input image set, returned as an imageSet object.

Compatibility Considerations

select is not recommended

Not recommended starting in R2016b

The imageSet object and its select function are not recommended. Instead, manage collections of image data using an imageDatastore object, and select subsets of images from the image datastore using the subset function. There are no plans to remove the select function of the imageSet object.

See Also

imageDatastore | subset

Introduced in R2014b

invertedImageIndex

Search index that maps visual words to images

Description

An `invertedImageIndex` object is a search index that stores a visual word-to-image mapping. You can use this object with the `retrieveImages` function to search for an image.

Creation

Syntax

```
imageIndex = invertedImageIndex(bag)
imageIndex = invertedImageIndex(bag, 'SaveFeatureLocations', tf)
```

Description

`imageIndex = invertedImageIndex(bag)` returns a search index object that stores the visual word-to-image mapping based on the input bag of visual words, `bag`. The `bag` argument sets the `bagOfFeatures` property.

`imageIndex = invertedImageIndex(bag, 'SaveFeatureLocations', tf)` specifies whether or not to save the feature location data in `imageIndex`. To save image feature locations in the `imageIndex` object, specify the logical value `tf` as `true`. You can use location data to verify the spatial or geometric image search results. If you do not require feature locations, you can reduce memory consumption by specifying `tf` as `false`.

Properties

ImageLocation — Indexed image locations

cell array

Indexed image locations, specified as a cell array that contains the path and folder locations of images.

ImageWords — Visual words

M-element vector of `visualWords` objects

Visual words, specified as a *M*-element vector of `visualWords` objects. *M* is the number of indexed images in the `invertedImageIndex` object. Each `visualWords` object contains the `WordIndex`, `Location`, `VocabularySize`, and `Count` properties for the corresponding indexed image.

WordFrequency — Word occurrence

N-element column

Word occurrence, specified as an *N*-element column. The column contains the percentage of images in which each visual word occurs. These percentages are analogous to document frequency in text retrieval applications.

To reduce the search set, when looking for the most relevant images, you can suppress the most common words. You can also suppress rare words that you suspect come from outliers in the image set.

You can control how much the top and bottom end of the visual word distribution affects the search results by tuning the `WordFrequencyRange` property.

BagOfFeatures — Bag of visual words

`bagOfFeatures` object

Bag of visual words, specified as the `bagOfFeatures` object used to create the index.

MatchThreshold — Required similarity percentage for potential image match

`0.01` (default) | numeric value in range `[0,1]`

Required similarity percentage for potential image match, specified as a numeric value in the range `[0,1]`. To obtain more search results, lower this threshold.

WordFrequencyRange — Word frequency range

`[0.01 0.9]` (default) | two-element vector

Word frequency range, specified as a two-element vector of a lower and an upper percentage, [*lower upper*]. Percentages must be in the range `[0, 1]`, and the value of *lower* must be less than the value of *upper*. Use the word frequency range to ignore common words (the upper percentage range) or rare words (the lower percentage range) within the image index. These words often occur as repeated patterns or outliers, respectively, and can reduce search accuracy. To find potential values for this property, before you set this value, plot the sorted `WordFrequency` values.

ImageID — Indexed image identifiers

vector of integers

Indexed image identifiers, specified as a vector of integers that uniquely identify indexed images. For visual SLAM workflows, you can set the value of `ImageID` equal to the value of the `ViewID` of the `imageviewset` when adding images. Using the same identifier for `invertedImageIndex` and `imageviewset` eliminates the need to index the same image differently in each object.

Object Functions

<code>addImages</code>	Add new images to image index
<code>removeImages</code>	Remove images from image index
<code>addImageFeatures</code>	Add features of image to image index

Examples

Search ROI for Object

Define a set of images to search.

```
imageFiles = ...
    {'elephant.jpg', 'cameraman.tif', ...
     'peppers.png', 'saturn.png', ...
     'pears.png', 'stapleRemover.jpg', ...
     'football.jpg', 'mandi.tif', ...
     'kids.tif', 'liftingbody.png', ...
```

```
'office_5.jpg', 'gantrycrane.png', ...  
'moon.tif',    'circuit.tif', ...  
'tape.png',   'coins.png'};
```

```
imgSet = imageSet(imageFiles);
```

Learn the visual vocabulary of the image view set.

```
bag = bagOfFeatures(imgSet, 'PointSelection', 'Detector', ...  
    'VocabularySize', 1000);
```

Creating Bag-Of-Features.

```
* Image category 1: <undefined>
```

```
* Selecting feature point locations using the Detector method.
```

```
* Extracting SURF features from the selected feature point locations.
```

```
** detectSURFFeatures is used to detect key points for feature extraction.
```

```
* Extracting features from 16 images in image set 1...done. Extracted 3680 features.
```

```
* Keeping 80 percent of the strongest features from each category.
```

```
* Balancing the number of features across all image categories to improve clustering.
```

```
** Image category 1 has the least number of strongest features: 2944.
```

```
** Using the strongest 2944 features from each of the other image categories.
```

```
* Creating a 1000 word visual vocabulary.
```

```
* Number of levels: 1
```

```
* Branching factor: 1000
```

```
* Number of clustering steps: 1
```

```
* [Step 1/1] Clustering vocabulary level 1.
```

```
* Number of features      : 2944
```

```
* Number of clusters      : 1000
```

```
* Initializing cluster centers...100.00%.
```

```
* Clustering...completed 24/100 iterations (~0.06 seconds/iteration)...converged in 24 iterations
```

```
* Finished creating Bag-Of-Features
```

Create an image search index and add the image view set images.

```
imageIndex = invertedImageIndex(bag);
```

```
addImages(imageIndex, imgSet);
```

Encoding images using Bag-Of-Features.

```
* Image category 1: <undefined>
```

```
* Encoding 16 images from image set 1...done.
```

```
* Finished encoding images.
```

Specify a query image and an ROI in which to search for the target object, an elephant. You can also use the `imrect` function to select an ROI interactively. For example, `queryROI = getPosition(imrect)`.

```
queryImage = imread('clutteredDesk.jpg');  
queryROI = [130 175 330 365];
```



```
figure
imshow(queryImage)
rectangle('Position',queryROI,'EdgeColor','yellow')
```

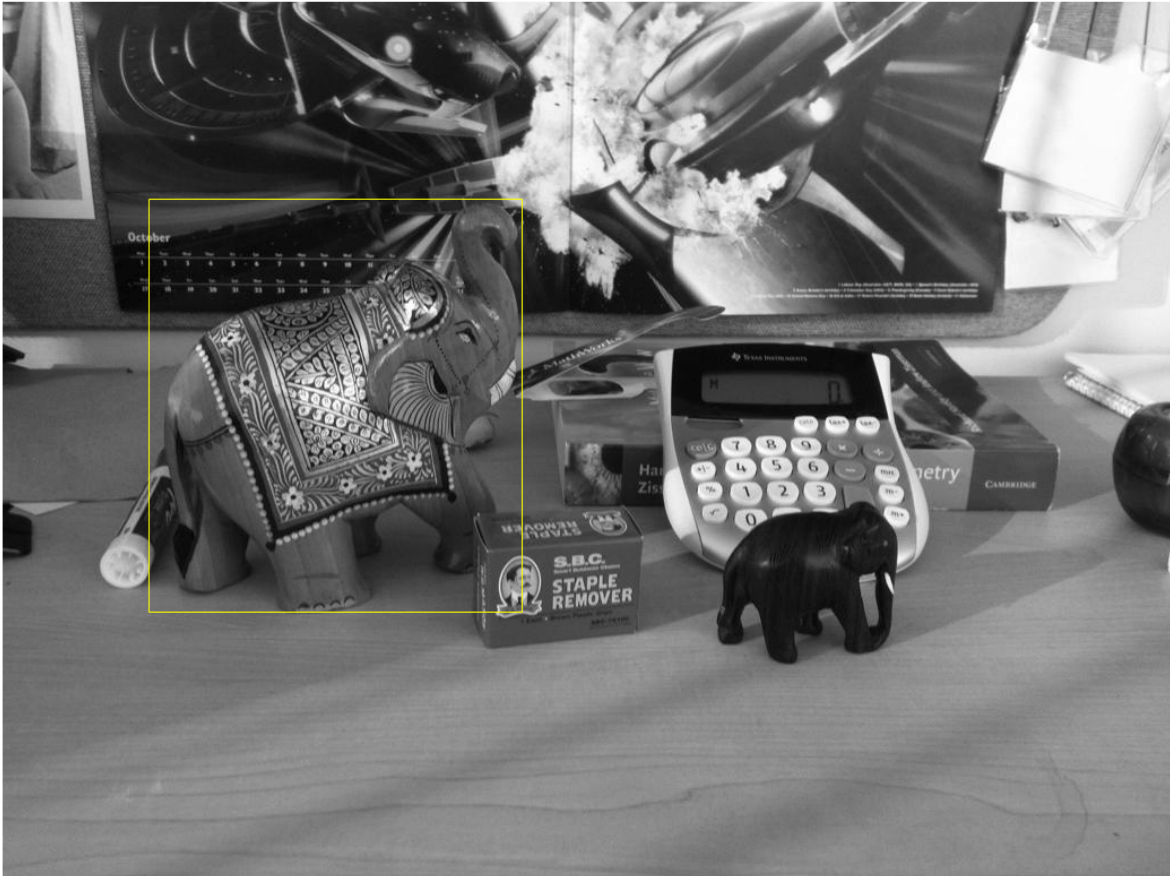

Find images that contain the object.

```
imageIDs = retrieveImages(queryImage,imageIndex,'ROI',queryROI)
```

```
imageIDs = 15x1 uint32 column vector
```

```
1
11
2
6
8
12
3
14
13
16
:
```

```
bestMatch = imageIDs(1);  
  
figure  
imshow(imageIndex.ImageLocation{bestMatch})
```



References

- [1] Sivic, J. and A. Zisserman. *Video Google: A text retrieval approach to object matching in videos*. ICCV (2003) pg 1470-1477.
- [2] Philbin, J., O. Chum, M. Isard, J. Sivic, and A. Zisserman. *Object retrieval with large vocabularies and fast spatial matching*. CVPR (2007).

See Also

[imageSet](#) | [bagOfFeatures](#) | [retrieveImages](#) | [evaluateImageRetrieval](#) | [indexImages](#)

Topics

“Image Retrieval Using Customized Bag of Features”
“Image Retrieval with Bag of Visual Words”

Introduced in R2015a

addImages

Add new images to image index

Syntax

```
addImages(imageIndex, imds)
addImages(imageIndex, I, imageId)
addImages( ____, Verbose=tf)
```

Description

`addImages(imageIndex, imds)` adds the images in `imds` to `imageIndex`.

`addImages(imageIndex, I, imageId)` adds an image, `I`, to `imageIndex`, specified by the image identifier `imageId`.

`addImages(____, Verbose=tf)` specifies whether or not to display progress information, in addition to any combination of input arguments from previous syntaxes. By default, the `addImages` function displays progress information. To hide the display, specify `tf` as `false`.

Examples

Add Image to Image Index

Define a set of images to search

```
imageFiles = ...
    {'elephant.jpg', 'cameraman.tif', ...
     'peppers.png', 'saturn.png', ...
     'pears.png',   'stapleRemover.jpg', ...
     'football.jpg', 'mandi.tif', ...
     'kids.tif',    'liftingbody.png', ...
     'office_5.jpg', 'gantrycrane.png', ...
     'moon.tif',    'circuit.tif', ...
     'tape.png',   'coins.png'};
```

```
imds = imageDatastore(imageFiles);
```

Learn the visual vocabulary of the image view set.

```
bag = bagOfFeatures(imds, 'PointSelection', 'Detector', ...
    'VocabularySize', 1000, 'Verbose', false);
```

Create an image search index.

```
imageIndex = invertedImageIndex(bag);
```

Add to the image view set images to the image search index.

```
addImages(imageIndex, imds);
```

```
Encoding images using Bag-Of-Features.  
-----
```

```
* Encoding 16 images...done.
```

Input Arguments

imageIndex — Image search index

`invertedImageIndex` object

Image search index, specified as an `invertedImageIndex` object.

imds — Images

`ImageDatastore` object

Images, specified as an `ImageDatastore` object. `imds` contains new images to add to an existing index. The function does not ignore duplicate images.

I — Input image

M -by- N -by-3 array | M -by- N 2-D matrix

Input image, specified as either an M -by- N -by-3 array, representing a truecolor image, or an M -by- N array, representing a 2-D grayscale image.

imageId — Indexed image identifier

positive integer

Indexed image identifier, specified as an positive integer.

Tips

- The `addImages` function supports parallel computing using multiple MATLAB workers. Enable parallel computing from the “Computer Vision Toolbox Preferences” dialog box. To open Computer Vision Toolbox preferences, on the **Home** tab, in the **Environment** section, select **Preferences**. Then select **Computer Vision Toolbox** .

See Also

`removeImages` | `addImageFeatures` | `invertedImageIndex`

Introduced in R2015a

removeImages

Remove images from image index

Syntax

```
removeImages(imageIndex, imageIds)
```

Description

`removeImages(imageIndex, imageIds)` removes the images from the `imageIndex` object that correspond to the `imageIds` input.

Examples

Remove Indexed Image

Create image set.

```
dataDir = fullfile(toolboxdir('vision'),'visiondata','imageSets','cups');  
imds = imageDatastore(dataDir);
```

Index the image set.

```
imageIndex = indexImages(imds)
```

```
Creating an inverted image index using Bag-Of-Features.  
-----
```

```
Creating Bag-Of-Features.  
-----
```

```
* Selecting feature point locations using the Detector method.  
* Extracting SURF features from the selected feature point locations.  
** detectSURFFeatures is used to detect key points for feature extraction.  
  
* Extracting features from 6 images...done. Extracted 1708 features.  
  
* Keeping 80 percent of the strongest features from each category.  
  
* Balancing the number of features across all image categories to improve clustering.  
** Image category 1 has the least number of strongest features: 1366.  
** Using the strongest 1366 features from each of the other image categories.  
  
* Creating a 1366 word visual vocabulary.  
* Number of levels: 1  
* Branching factor: 1366  
* Number of clustering steps: 1  
  
* [Step 1/1] Clustering vocabulary level 1.  
* Number of features      : 1366  
* Number of clusters     : 1366
```

```
* Initializing cluster centers...100.00%.
* Clustering...completed 1/100 iterations (~0.10 seconds/iteration)...converged in 1 iterations.

* Finished creating Bag-Of-Features
```

```
Encoding images using Bag-Of-Features.
-----
```

```
* Encoding 6 images...done.
Finished creating the image index.
```

```
imageIndex =
  invertedImageIndex with properties:

    ImageLocation: {6x1 cell}
    ImageWords: [6x1 vision.internal.visualWords]
    WordFrequency: [1x1366 double]
    BagOfFeatures: [1x1 bagOfFeatures]
    ImageID: [1 2 3 4 5 6]
    MatchThreshold: 0.0100
    WordFrequencyRange: [0.0100 0.9000]
```

```
imageIndex.ImageLocation
```

```
ans = 6x1 cell
    {'B:\matlab\toolbox\vision\visiondata\imageSets\cups\bigMug.jpg' }
    {'B:\matlab\toolbox\vision\visiondata\imageSets\cups\blueCup.jpg' }
    {'B:\matlab\toolbox\vision\visiondata\imageSets\cups\handMade.jpg' }
    {'B:\matlab\toolbox\vision\visiondata\imageSets\cups\holdingCup.jpg'}
    {'B:\matlab\toolbox\vision\visiondata\imageSets\cups\plaid.jpg' }
    {'B:\matlab\toolbox\vision\visiondata\imageSets\cups\plainWhite.jpg'}
```

```
Remove first and third image.
```

```
removeImages(imageIndex,[1 3]);
imageIndex.ImageLocation
```

```
ans = 4x1 cell
    {'B:\matlab\toolbox\vision\visiondata\imageSets\cups\blueCup.jpg' }
    {'B:\matlab\toolbox\vision\visiondata\imageSets\cups\holdingCup.jpg'}
    {'B:\matlab\toolbox\vision\visiondata\imageSets\cups\plaid.jpg' }
    {'B:\matlab\toolbox\vision\visiondata\imageSets\cups\plainWhite.jpg'}
```

Input Arguments

imageIndex — Image search index

`invertedImageIndex` object

Image search index, specified as an `invertedImageIndex` object.

imageIds — Image identifiers

vector of positive integers

Image identifiers, specified as a vector of positive integers. The image identifiers correspond to the identifiers in `imageIndex.ImageID`, where `ImageID` is a property of the `invertedImageIndex` object.

See Also

`addImages` | `addImageFeatures` | `invertedImageIndex`

Introduced in R2015a

addImageFeatures

Add features of image to image index

Syntax

```
addImageFeatures(imageIndex, features, imageId)
```

Description

`addImageFeatures(imageIndex, features, imageId)` adds the features features of an image to `imageIndex`, and assigns the features using the unique image identifier `imageId`.

Examples

Add Image Features of Image Image Index

Define a set of images.

```
imageFiles = ...
    {'elephant.jpg', 'cameraman.tif', ...
     'peppers.png', 'saturn.png', ...
     'pears.png', 'stapleRemover.jpg', ...
     'football.jpg', 'mandi.tif', ...
     'kids.tif', 'liftingbody.png', ...
     'office_5.jpg', 'gantrycrane.png', ...
     'moon.tif', 'circuit.tif', ...
     'tape.png'};
```

Create an image datastore containing the images.

```
imds = imageDatastore(imageFiles);
```

Learn the visual vocabulary of the images.

```
bag = bagOfFeatures(imds);
```

Creating Bag-Of-Features.

```
* Selecting feature point locations using the Grid method.
* Extracting SURF features from the selected feature point locations.
** The GridStep is [8 8] and the BlockWidth is [32 64 96 128].

* Extracting features from 15 images...done. Extracted 655092 features.

* Keeping 80 percent of the strongest features from each category.

* Creating a 500 word visual vocabulary.
* Number of levels: 1
* Branching factor: 500
* Number of clustering steps: 1
```

```
* [Step 1/1] Clustering vocabulary level 1.
* Number of features      : 524074
* Number of clusters     : 500
* Initializing cluster centers...100.00%.
* Clustering...completed 19/100 iterations (~1.20 seconds/iteration)...converged in 19 iterations
* Finished creating Bag-Of-Features
```

Create an image search index.

```
imageIndex = invertedImageIndex(bag, 'SaveFeatureLocations', false);
```

Load an image and extract features from it.

```
I = imread('coins.png');
```

Detect SURF points from the image.

```
points = detectSURFFeatures(I);
```

Extract image features from the SURF points.

```
features = extractFeatures(I, points);
```

Add the image features into the image index.

```
imageId = 1;
addImageFeatures(imageIndex, features, imageId)
```

Input Arguments

imageIndex — Image search index

`invertedImageIndex` object

Image search index, specified as an `invertedImageIndex` object.

features — Feature descriptors

M -by- N matrix | `binaryFeatures` object

Feature descriptors, specified as an M -by- N matrix or a `binaryFeatures` object. Each descriptor is of length N . To add image features to the image index using `addImageFeatures`, you must set the `SaveFeatureLocations` property of the `invertedImageIndex` object to `false`.

imageId — Indexed image identifier

positive integer

Indexed image identifier, specified as a positive integer.

See Also

`invertedImageIndex` | `removeImages` | `addImages`

Introduced in R2021b

cameraCalibrationErrors

Object for storing standard errors of estimated camera parameters

Description

cameraCalibrationErrors contains the standard errors of estimated camera parameters. You can access the intrinsics and extrinsics standard errors using the object properties. You can display the standard errors using the object's displayErrors object function.

Creation

Syntax

Description

Create an cameraCalibrationErrors object by calling the estimateCameraParameters function with image points and world points.

```
[params,imgsUsed,Errors] = estimateCameraParameters(imagePoints,worldPoints)
```

Properties

IntrinsicsErrors — Standard intrinsics error

intrinsicsEstimationErrors object

Standard error of the estimated intrinsics for a camera, specified as a intrinsicsEstimationErrors object.

ExtrinsicsErrors — Standard extrinsics error

extrinsicsEstimationErrors object

Standard error of the estimate rotations and translations for a camera relative to the calibration pattern, specified as a extrinsicsEstimationErrors object.

Object Functions

displayErrors Display standard errors of camera parameter estimates

ExamplesEstimate and Display Camera Calibration Standard Errors

Estimate and Display Camera Calibration Standard Errors

Create a set of calibration images.

```
images = imageDatastore(fullfile(toolboxdir('vision'),'visiondata', ...
    'calibration','mono'));
```

Detect the calibration pattern.

```
[imagePoints,boardSize] = detectCheckerboardPoints(images.Files);
```

Generate the world coordinates of the corners of the squares. The units of the square are in millimeters.

```
squareSize = 29;
worldPoints = generateCheckerboardPoints(boardSize,squareSize);
```

Calibrate the camera.

```
I = readimage(images,1);
imageSize = [size(I,1),size(I,2)];
[params,~,errors] = estimateCameraParameters(imagePoints,worldPoints, ...
      'ImageSize',imageSize);
```

Display the standard errors.

```
displayErrors(errors,params);
```

```
Standard Errors of Estimated Camera Parameters
```

```
-----
```

Intrinsics

```
-----
```

```
Focal length (pixels): [ 714.1886 +/- 3.3219      710.3785 +/- 4.0579 ]
Principal point (pixels):[ 563.6481 +/- 5.3967      355.7252 +/- 3.3036 ]
Radial distortion: [ -0.3536 +/- 0.0091      0.1730 +/- 0.0488 ]
```

Extrinsics

```
-----
```

Rotation vectors:

```
[ -0.6096 +/- 0.0054      -0.1789 +/- 0.0073      -0.3835 +/- 0.0024
 [ -0.7283 +/- 0.0050      -0.0996 +/- 0.0072      0.1964 +/- 0.0021
 [ -0.6722 +/- 0.0051      -0.1444 +/- 0.0074      -0.1329 +/- 0.0020
 [ -0.5836 +/- 0.0056      -0.2901 +/- 0.0074      -0.5622 +/- 0.0021
 [ -0.3157 +/- 0.0065      -0.1441 +/- 0.0075      -0.1067 +/- 0.0011
 [ -0.7581 +/- 0.0052      0.1947 +/- 0.0072      0.4324 +/- 0.0030
 [ -0.7515 +/- 0.0051      0.0767 +/- 0.0072      0.2070 +/- 0.0029
 [ -0.6223 +/- 0.0053      0.0231 +/- 0.0073      0.3663 +/- 0.0020
 [ 0.3443 +/- 0.0063      -0.2226 +/- 0.0073      -0.0437 +/- 0.0014
```

Translation vectors (mm):

```
[ -146.0517 +/- 6.0391      -26.8685 +/- 3.7318      797.9026 +/- 3.9002
 [ -209.4358 +/- 6.9637      -59.4565 +/- 4.3578      921.8198 +/- 4.6295
 [ -129.3825 +/- 7.0907      -44.1030 +/- 4.3751      937.6831 +/- 4.4911
 [ -151.0049 +/- 6.6905      -27.3253 +/- 4.1339      884.2788 +/- 4.3921
 [ -174.9500 +/- 6.7056      -24.3499 +/- 4.1606      886.4961 +/- 4.6680
 [ -134.3097 +/- 7.8887      -103.4981 +/- 4.8925      1042.4553 +/- 4.8184
 [ -173.9846 +/- 7.6891      -73.1691 +/- 4.7812      1017.2385 +/- 4.8120
 [ -202.9448 +/- 7.4327      -87.9091 +/- 4.6482      983.6957 +/- 4.9077
 [ -319.8862 +/- 6.3213      -119.8898 +/- 4.0922      829.4581 +/- 4.9591
```

Create a set of calibration images.

```
images = imageDatastore(fullfile(toolboxdir('vision'),'visiondata', ...
      'calibration','mono'));
```

Detect the calibration pattern.

```
[imagePoints,boardSize] = detectCheckerboardPoints(images.Files);
```

Generate the world coordinates of the corners of the squares. The units of the square are in millimeters.

```
squareSize = 29;
worldPoints = generateCheckerboardPoints(boardSize,squareSize);
```

Calibrate the camera.

```
I = readimage(images,1);
imageSize = [size(I,1),size(I,2)];
[params,~,errors] = estimateCameraParameters(imagePoints,worldPoints, ...
      'ImageSize',imageSize);
```

Display the standard errors.

```
displayErrors(errors,params);
```

Standard Errors of Estimated Camera Parameters

Intrinsics

```
-----
Focal length (pixels): [ 714.1886 +/- 3.3219      710.3785 +/- 4.0579 ]
Principal point (pixels):[ 563.6481 +/- 5.3967      355.7252 +/- 3.3036 ]
Radial distortion: [ -0.3536 +/- 0.0091      0.1730 +/- 0.0488 ]
```

Extrinsics

```
-----
Rotation vectors:
[ -0.6096 +/- 0.0054      -0.1789 +/- 0.0073      -0.3835 +/- 0.0024 ]
[ -0.7283 +/- 0.0050      -0.0996 +/- 0.0072      0.1964 +/- 0.0021 ]
[ -0.6722 +/- 0.0051      -0.1444 +/- 0.0074      -0.1329 +/- 0.0020 ]
[ -0.5836 +/- 0.0056      -0.2901 +/- 0.0074      -0.5622 +/- 0.0021 ]
[ -0.3157 +/- 0.0065      -0.1441 +/- 0.0075      -0.1067 +/- 0.0019 ]
[ -0.7581 +/- 0.0052      0.1947 +/- 0.0072      0.4324 +/- 0.0030 ]
[ -0.7515 +/- 0.0051      0.0767 +/- 0.0072      0.2070 +/- 0.0029 ]
[ -0.6223 +/- 0.0053      0.0231 +/- 0.0073      0.3663 +/- 0.0029 ]
[ 0.3443 +/- 0.0063      -0.2226 +/- 0.0073      -0.0437 +/- 0.0019 ]
```

Translation vectors (mm):

```
[ -146.0517 +/- 6.0391      -26.8685 +/- 3.7318      797.9026 +/- 3.9007 ]
[ -209.4358 +/- 6.9637      -59.4565 +/- 4.3578      921.8198 +/- 4.6291 ]
[ -129.3825 +/- 7.0907      -44.1030 +/- 4.3751      937.6831 +/- 4.4911 ]
[ -151.0049 +/- 6.6905      -27.3253 +/- 4.1339      884.2788 +/- 4.3921 ]
[ -174.9500 +/- 6.7056      -24.3499 +/- 4.1606      886.4961 +/- 4.6680 ]
[ -134.3097 +/- 7.8887      -103.4981 +/- 4.8925      1042.4553 +/- 4.8184 ]
[ -173.9846 +/- 7.6891      -73.1691 +/- 4.7812      1017.2385 +/- 4.8120 ]
[ -202.9448 +/- 7.4327      -87.9091 +/- 4.6482      983.6957 +/- 4.9071 ]
[ -319.8862 +/- 6.3213      -119.8898 +/- 4.0922      829.4581 +/- 4.9591 ]
```

See Also

Apps

Stereo Camera Calibrator | Camera Calibrator

Classes

cameraParameters | stereoParameters | stereoCalibrationErrors |
intrinsicEstimationErrors | extrinsicEstimationErrors

Functions

estimateCameraParameters | showReprojectionErrors | showExtrinsics |
undistortImage | undistortPoints | detectCheckerboardPoints |
generateCheckerboardPoints

Topics

“Evaluating the Accuracy of Single Camera Calibration”
“Using the Single Camera Calibrator App”

Introduced in R2014b

stereoCalibrationErrors

Object for storing standard errors of estimated stereo parameters

Description

The `stereoCalibrationErrors` object contains the standard errors of estimated stereo parameters. You can access the standard errors for stereo calibration using the object properties. You can display the standard errors using the `displayErrors` object function.

Creation

Syntax

```
[params,imgsUsed,Errors] = estimateCameraParameters(imagePoints,worldPoints)
```

Description

`[params,imgsUsed,Errors] = estimateCameraParameters(imagePoints,worldPoints)` creates a `stereoCalibrationErrors` object by calling the `estimateCameraParameters` function with image points and world points from a stereo camera. The function returns the `stereoCalibrationErrors` object as the third output argument. .

Properties

Camera1IntrinsicsErrors — Standard errors of for camera one estimated intrinsics

`intrinsicsEstimationErrors` object

Standard errors of for camera one estimated intrinsics and distortion coefficients, specified as an `intrinsicsEstimationErrors` object.

Camera1ExtrinsicsErrors — Standard errors of camera one estimated extrinsics

`extrinsicsEstimationErrors` object

Standard errors of camera one estimated extrinsics, specified as an `extrinsicsEstimationErrors` object.

Camera2IntrinsicsErrors — Standard errors of for camera two estimated intrinsics

`intrinsicsEstimationErrors` object

Standard errors of for camera two estimated intrinsics and distortion coefficients, specified as an `intrinsicsEstimationErrors` object.

RotationOfCamera2Error — Standard errors of the rotated vector of camera two relative to camera one

three-element vector

Standard errors of the rotated vector of camera two relative to camera one, specified as a three-element vector.

TranslationOfCamera2Error — Standard errors of the translation of camera two relative to camera one

three-element vector

Standard errors of the translation of camera two relative to camera one, specified as a three-element vector.

Object Functions

`displayErrors` Display standard errors of camera parameter estimates

Examples**Estimate and Display Stereo Calibration Standard Errors**

Specify two sets of calibration images.

```
imageDir = fullfile(toolboxdir("vision"),"visiondata", ...
    "calibration","stereo");
leftImages = imageDatastore(fullfile(imageDir,"left"));
rightImages = imageDatastore(fullfile(imageDir,"right"));
```

Detect the checkerboards.

```
[imagePoints,boardSize] = detectCheckerboardPoints( ...
    leftImages.Files,rightImages.Files);
```

Generate the world coordinates of the corners of the squares. Square size is in millimeters.

```
squareSize = 108;
worldPoints = generateCheckerboardPoints(boardSize,squareSize);
```

Calibrate the stereo camera system. Here, both cameras have the same resolution.

```
I = readimage(leftImages,1);
imageSize = [size(I,1) size(I,2)];
[params,~, errors] = estimateCameraParameters(imagePoints,worldPoints, ...
    ImageSize=imageSize);
```

Display standard stereo calibration errors.

```
displayErrors(errors,params);
```

```
Standard Errors of Estimated Stereo Camera Parameters
-----
```

```
Camera 1 Intrinsic
-----
```

```
Focal length (pixels): [ 1038.0286 +/- 0.6533    1037.9145 +/- 0.6389 ]
Principal point (pixels):[ 656.0841 +/- 0.3408    485.5485 +/- 0.2639 ]
Radial distortion:      [ -0.3617 +/- 0.0008         0.1866 +/- 0.0026 ]
```

```
Camera 1 Extrinsic
-----
```

```
Rotation vectors:
[ 0.1680 +/- 0.0007    -0.0271 +/- 0.0006    3.1125 +/- 0.000
```



```

[ 0.1995 +/- 0.0006    -0.0523 +/- 0.0005    -3.0991 +/- 0.0000
[ 0.4187 +/- 0.0005    -0.1061 +/- 0.0004    -3.1113 +/- 0.0000
[ 0.5239 +/- 0.0005    -0.0604 +/- 0.0004    -3.0552 +/- 0.0000
[ 0.6807 +/- 0.0006    -0.0306 +/- 0.0005    -3.0331 +/- 0.0000
[ 0.3513 +/- 0.0007    -0.0993 +/- 0.0006    -3.0334 +/- 0.0000
[ 0.0212 +/- 0.0007    -0.1179 +/- 0.0007    -3.0833 +/- 0.0000
[ -0.2765 +/- 0.0008    -0.0847 +/- 0.0007    -3.0943 +/- 0.0000
[ -0.4407 +/- 0.0007    -0.1119 +/- 0.0006    -3.0652 +/- 0.0000
[ -0.2537 +/- 0.0008    -0.1334 +/- 0.0007    -3.1039 +/- 0.0000

```

Translation vectors (mm):

```

[ 708.4192 +/- 0.4914    227.0500 +/- 0.4002    1492.8672 +/- 1.0120
[ 368.4408 +/- 0.5228    191.7200 +/- 0.4094    1589.9146 +/- 0.9980
[ 226.3710 +/- 0.5173    191.1429 +/- 0.4030    1578.4779 +/- 0.9570
[ 49.5377 +/- 0.5183     196.7495 +/- 0.4030    1580.5404 +/- 0.9490
[ -172.4001 +/- 0.7003   150.9910 +/- 0.5406    2119.3253 +/- 1.2530
[ 10.7777 +/- 0.6784     176.8785 +/- 0.5276    2066.8343 +/- 1.2900
[ 295.4840 +/- 0.6616    167.8675 +/- 0.5158    2010.7713 +/- 1.2730
[ 614.2338 +/- 0.6457    166.2016 +/- 0.5153    1968.1798 +/- 1.2720
[ 767.0156 +/- 0.6106    165.5372 +/- 0.4991    1868.3334 +/- 1.2390
[ 953.8133 +/- 0.7336    -14.7981 +/- 0.6039    2255.6170 +/- 1.5100

```

Camera 2 Intrinsic

```

Focal length (pixels): [ 1042.4817 +/- 0.6644    1042.2692 +/- 0.6534 ]
Principal point (pixels): [ 640.5972 +/- 0.3305    479.0652 +/- 0.2633 ]
Radial distortion: [ -0.3614 +/- 0.0007    0.1822 +/- 0.0022 ]

```

Position And Orientation of Camera 2 Relative to Camera 1

```

Rotation of camera 2: [ -0.0037 +/- 0.0002    0.0050 +/- 0.0004    -0.0002 +/- 0.0000
Translation of camera 2 (mm): [ -119.8720 +/- 0.0401    -0.4005 +/- 0.0414    -0.0258 +/- 0.0000

```

See Also

Apps

Stereo Camera Calibrator | **Camera Calibrator**

Classes

cameraParameters | stereoParameters | cameraCalibrationErrors |
intrinsicEstimationErrors | extrinsicEstimationErrors

Functions

estimateCameraParameters | showReprojectionErrors | showExtrinsic |
undistortImage | undistortPoints | detectCheckerboardPoints |
generateCheckerboardPoints

Topics

“Evaluating the Accuracy of Single Camera Calibration”
“Using the Single Camera Calibrator App”
“Using the Stereo Camera Calibrator App”

Introduced in R2014b

displayErrors

Display standard errors of camera parameter estimation

Syntax

```
displayErrors(estimationErrors, stereoParams)
```

Description

`displayErrors(estimationErrors, stereoParams)` displays stereo parameters and corresponding standard errors to the screen. The `estimationErrors` input must be a `stereoCalibrationErrors` object. The `stereoParams` input must be a `stereoParameters` object.

MSERRegions

Object for storing MSER regions

Description

This object describes MSER regions and corresponding ellipses that have the same second moments as the regions. It passes data between the `detectMSERFeatures` and `extractFeatures` functions. The object can also be used to manipulate and plot the data returned by these functions.

Creation

Syntax

```
regions = MSERRegions(pixellist)
```

Description

`regions = MSERRegions(pixellist)` constructs an MSER regions object, `regions` regions from the pixel list, `pixellist`.

Input Arguments

pixellist — Point coordinates for detected MSER regions

M-by-1 cell array

Point coordinates for detected MSER regions, specified as a *M*-by-1 cell array. Each cell contains a *P*-by-2 array of [x y] coordinates for the detected MSER regions, where *P* varies based on the number of pixels in a region.

Properties

Location — Locations of ellipses

M-by-2 array (default)

This property is read-only.

Locations of ellipses, stored as an *M*-by-2 array of [x y] coordinates. The ellipses that have the same second moments as the MSER regions.

Axes — Major and minor axis

two-element vector (default)

This property is read-only.

Major and minor axis, stored as a two-element vector, [majorAxis minorAxis]. This vector specifies the major and minor axis of the ellipse that have the same second moments as the MSER regions.

Orientation — Ellipse orientation

scalar in the range $-\pi/2$ to $+\pi/2$

This property is read-only.

Ellipse orientation, stored as a value in the range from $-\pi/2$ to $+\pi/2$ radians. This value represents the orientation of the ellipse as measured from the X-axis to the major axis of the ellipse. You can use this property for visualization purposes.

Count — Number of stored regions

0 (default) | integer

Number of stored regions, specified as an integer.

Object Functions

<code>isempty</code>	Determine if points object is empty
<code>length</code>	Number of stored points
<code>size</code>	Return size of points object
<code>plot</code>	Plot MSER regions

Examples**Detect MSER Features in an Image**

Load an image.

```
I = imread('cameraman.tif');
```

Detect and store regions.

```
regions = detectMSEFeatures(I);
```

Display the centroids and axes of detected regions.

```
imshow(I); hold on;  
plot(regions);
```



Display MSER Feature Regions from the MSERRegions Object

Detect and display the first 10 regions contained in the MSERRegions object.

Detect MSER features.

```
I = imread('cameraman.tif');  
regions = detectMSERFeatures(I);
```

Display the first 10 regions in the MSERRegions object.

```
imshow(I); hold on;  
plot(regions(1:10), 'showPixelList', true);
```

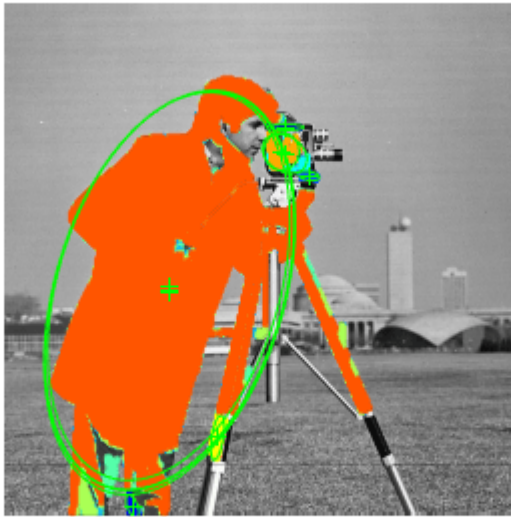

Combine MSER Region Detector with SURF Descriptors

Extract and display SURF descriptors at locations identified by MSER detector.

Read image.

```
I = imread('cameraman.tif');
```

Detect MSER features.

```
regionsObj = detectMSEFeatures(I);
```

Extract and display SURF descriptors.

```
[features, validPtsObj] = extractFeatures(I, regionsObj);  
imshow(I); hold on;  
plot(validPtsObj, 'showOrientation', true);
```



Tips

Although `MSERRegions` may hold many regions, it is a scalar object. Therefore, `numel(MSERRegions)` always returns 1. This value may differ from `length(MSERRegions)`, which returns the true number of regions held by the object.

References

- [1] Nister, D., and H. Stewenius, "Linear Time Maximally Stable Extremal Regions", *Lecture Notes in Computer Science*. 10th European Conference on Computer Vision, Marseille, France: 2008, no. 5303, pp. 183-196.
- [2] Matas, J., O. Chum, M. Urba, and T. Pajdla. "Robust wide baseline stereo from maximally stable extremal regions." *Proceedings of British Machine Vision Conference*, pages 384-396, 2002.

Extended Capabilities

C/C++ Code Generation

Generate C and C++ code using MATLAB® Coder™.

Usage notes and limitations:

- For code generation, you must specify both the `pixellist` cell array and the `length` of each array, as the second input. The object outputs, `regions.PixelList` as an array. The region sizes are defined in `regions.Lengths`.

See Also

`detectMSERFeatures` | `detectSURFFeatures` | `edge` | `extractFeatures` | `matchFeatures` | `SURFPoints` | `cornerPoints` | `BRISKPoints` | `KAZEPoints` | `ORBPoints`

Topics

“Find MSER Regions in an Image” on page 3-413

“Detect SURF Interest Points in a Grayscale Image” on page 3-425

“Automatically Detect and Recognize Text in Natural Images”

Introduced in R2012a

cornerPoints

Object for storing corner points

Description

This object stores information about feature points detected from a 2-D grayscale image.

Creation

Syntax

```
points = cornerPoints(location)
points = cornerPoints(location,Name,Value)
```

Description

`points = cornerPoints(location)` constructs a `cornerPoints` object from an M -by-2 array $[x\ y]$ of location coordinates.

`points = cornerPoints(location,Name,Value)` sets properties using one or more name-value pairs. Enclose each property name in quotes. For example, `points = cornerPoints('Metric',0.0)`

Input Arguments

location — Location coordinates

M -by-2 array

Location of points, specified as an M -by-2 array of $[x\ y]$ coordinates.

Properties

Location — Location of keypoints

`[]` (default) | M -by-2 matrix

This property is read-only.

Location of keypoints, specified as an M -by-2 matrix. Each row is of the form $[x\ y]$ and represents the location of a keypoint. M is the number of keypoints. You cannot set this property, use the `location` input argument instead.

Count — Number of points

0 (default) | integer

Number of points held by the corner points object, specified as a numeric value.

Metric — Strength of detected feature

0.0 (default) | numeric scalar

Strength of detected feature, specified as a numeric value. The algorithm uses a determinant of an approximated Hessian.

Object Functions

plot	Plot points
isempty	Determine if points object is empty
length	Number of stored points
selectStrongest	Select points with strongest metrics
size	Return size of points object
selectUniform	Select uniformly distributed subset of feature points
gather	Retrieve cornerPoints from the GPU

Examples

Plot Strongest Features from Detected Feature Points

Read an image.

```
I = imread('cameraman.tif');
```

Detect feature points.

```
points = detectHarrisFeatures(I);
```

Display the ten strongest points.

```
strongest = selectStrongest(points,10);  
imshow(I)  
hold on  
plot(strongest)
```



Display the (x,y) coordinates of the strongest points.

```
strongest.Location
```

```
ans = 10x2 single matrix
```

```
112.4516  208.4412
108.6510  228.1681
136.6969  114.7962
181.4160  205.9876
135.5823  123.4529
100.4951  174.3253
146.7581   94.7393
135.2899   92.6485
129.8439  110.0350
130.5716   91.0424
```

Create Corner Points Object and Display Points

Create a checkerboard image.

```
I = checkerboard(50,2,2);
```

Load the locations of corner points.

```
location = [51    51    51   100   100   100   151   151   151; ...
            50   100   150    50   101   150    50   100   150]';
```

Save the points in a cornerPoints object.

```
points = cornerPoints(location);
```

Display the points on the checkerboard.

```
imshow(I)
hold on
plot(points)
```

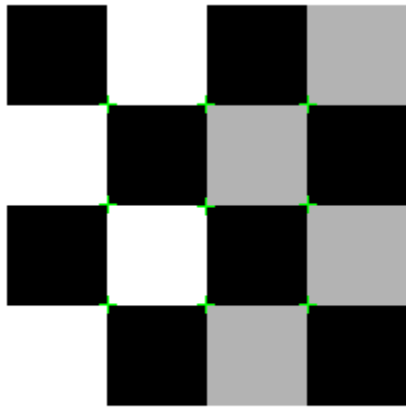

Tips

Although `cornerPoints` may hold many points, it is a scalar object. Therefore, `numel(cornerPoints)` always returns 1. This value may differ from `length(cornerPoints)`, which returns the true number of points held by the object.

Extended Capabilities

C/C++ Code Generation

Generate C and C++ code using MATLAB® Coder™.

Usage notes and limitations:

- To index locations with this object, use the syntax: `points.Location(idx, :)`, for `points` object. See `visionRecoverTransformCodeGeneration_kernel.m`, which is used in the “Introduction to Code Generation with Feature Matching and Registration” example.

See Also

`binaryFeatures` | `detectHarrisFeatures` | `detectFASTFeatures` | `detectMinEigenFeatures` | `detectBRISKFeatures` | `detectSURFFeatures` | `detectMSERFeatures` | `extractFeatures` | `extractHOGFeatures` | `matchFeatures` | `MSERRegions` | `detectORBFeatures` | `ORBPoints` | `SURFPoints` | `BRISKPoints` | `KAZEPoints`

Introduced in R2012a

SURFPoints

Object for storing SURF interest points

Description

This object provides the ability to pass data between the `detectSURFFeatures` and `extractFeatures` functions. It can also be used to manipulate and plot the data returned by these functions. You can use the object to fill the points interactively. You can use this approach in situations where you might want to mix a non-SURF interest point detector with a SURF descriptor.

Creation

Syntax

```
points = SURFPoints(location)
points = SURFPoints(location,Name,Value)
```

Description

`points = SURFPoints(location)` constructs a SURFPoints object from an M -by-2 array of $[x\ y]$ point coordinates.

`points = SURFPoints(location,Name,Value)` sets properties using one or more name-value pairs. Enclose each property name in quotes. For example, `points = SURFPoints('Metric',0.0)`

Input Arguments

location — Point coordinates

M -by-2 array of $[x\ y]$ point coordinates.

Point coordinates, specified as an M -by-2 array of form $[x\ y]$ coordinates. M denotes the number of points.

Properties

Count — Number of points

0 (default) | integer

Number of points held by the object, specified as a numeric value.

location — Point locations

M -by-2 array (default)

Point locations, specified as an M -by-2 array of $[x\ y]$ point coordinates.

Scale — Scale

12.0 (default) | scalar

Scale at which the feature is detected, specified as a value greater than or equal to 1.6.

Metric — Strength of detected feature

0.0 (default) | numeric scalar

Strength of detected feature, specified as a numeric value.

Orientation — Orientation

0.0 (default) | angle in radians

Orientation of the detected feature, specified as an angle, in radians. The angle is measured counter-clockwise from the X-axis with the origin specified by the `Location` property. Do not set this property manually. Rely instead, on the call to `extractFeatures` to fill in this value. The `extractFeatures` function modifies the default value of 0.0. The `Orientation` is mainly useful for visualization purposes.

SignOfLaplacian — Sign of Laplacian

0 (default) | -1 | 1

Sign of the Laplacian determined during the detection process, specified as -1, 0, or 1. You can use this parameter to accelerate the feature matching process.

Blobs with identical metric values but different signs of Laplacian can differ by their intensity values. For example, a white blob on a black background versus a black blob on a white background. You can use this parameter to quickly eliminate blobs that do not match.

For non-SURF detectors, this property is not relevant. For example, for corner features, you can simply use the default value of 0.

Object Functions

<code>plot</code>	Plot points
<code>isempty</code>	Determine if points object is empty
<code>length</code>	Number of stored points
<code>selectStrongest</code>	Select points with strongest metrics
<code>size</code>	Return size of points object
<code>selectUniform</code>	Select uniformly distributed subset of feature points

Examples

Detect SURF Features

Read in image.

```
I = imread('cameraman.tif');
```

Detect SURF features.

```
points = detectSURFFeatures(I);
```

Display location and scale for the 10 strongest points.

```
strongest = points.selectStrongest(10);  
imshow(I); hold on;  
plot(strongest);
```



Display [x y] coordinates for the 10 strongest points on command line.

```

strongest.Location
ans = 10x2 single matrix

139.7482    95.9542
107.4502   232.0347
116.6112   138.2446
105.5152   172.1816
113.6975    48.7220
104.4210    75.7348
111.3914   154.4597
106.2879   175.2709
131.1298    98.3900
124.2933    64.4942

```

Detect SURF Features and Display the Last 5 Points

Read in image.

```
I = imread('cameraman.tif');
```

Detect SURF feature.

```
points = detectSURFFeatures(I);
```

Display the last 5 points.

```
imshow(I); hold on;
plot(points(end-4:end));
```



Tips

Although `SURFPoints` may hold many points, it is a scalar object. Therefore, `numel(surfPoints)` always returns 1. This value may differ from `length(surfPoints)`, which returns the true number of points held by the object.

References

[1] Bay, H., A. Ess, T. Tuytelaars, and L. Van Gool. "SURF:Speeded Up Robust Features." *Computer Vision and Image Understanding (CVIU)*. Vol. 110, No. 3, pp. 346-359, 2008.

Extended Capabilities

C/C++ Code Generation

Generate C and C++ code using MATLAB® Coder™.

Usage notes and limitations:

- To index locations with this object, use the syntax: `points.Location(idx, :)`, for `points` object. See `visionRecoverTransformCodeGeneration_kernel.m`, which is used in the "Introduction to Code Generation with Feature Matching and Registration" example.

See Also

Objects

`SIFTPoints` | `MSERRegions` | `BRISKPoints` | `cornerPoints` | `ORBPoints` | `KAZEPoints`

Functions

detectSIFTFeatures | detectBRISKFeatures | detectFASTFeatures | detectKAZEFeatures
| detectORBFeatures | detectMinEigenFeatures | detectHarrisFeatures |
detectMSERFeatures | detectSURFFeatures | extractFeatures | matchFeatures

Topics

“Detect SURF Interest Points in a Grayscale Image” on page 3-425

“Display MSER Feature Regions from the MSERRegions Object” on page 2-457

“Find MSER Regions in an Image” on page 3-413

“Detect MSER Features in an Image” on page 2-456

Introduced in R2011b

ORBPoints

Object for storing ORB keypoints

Description

An `ORBPoints` object stores the Oriented FAST and rotated BRIEF (ORB) keypoints in an image. You can specify the keypoints and store them as an `ORBPoints` object. You can also use the `detectORBFeatures` function to detect the ORB keypoints in an image. The `detectORBFeatures` function stores the detected ORB keypoints as an `ORBPoints` object. Use “Object Functions” on page 2-471 to plot, select, and manipulate the detected ORB keypoints.

Creation

Syntax

```
points = ORBPoints
points = ORBPoints(location)
points = ORBPoints(location,Name,Value)
```

Description

`points = ORBPoints` creates an `ORBPoints` object with default property values.

`points = ORBPoints(location)` creates an `ORBPoints` object from a set of location coordinates specified by `location`. The `location` input sets the `Location` property.

`points = ORBPoints(location,Name,Value)` sets properties of the object using one or more name-value pair arguments. Enclose each property name in quotes. For example, `ORBPoints(location, 'Count', 15)` creates an `ORBPoints` object with `Count` property set to 15.

Properties

Location — Location of keypoints

`[]` (default) | *M*-by-2 matrix

This property is read-only.

Location of keypoints, specified as an *M*-by-2 matrix. Each row is of the form `[x y]` and represents the location of a keypoint. *M* is the number of keypoints. You cannot set this property as a name-value pair. Use the `location` input argument.

Metric — Strength of keypoints

`[]` (default) | scalar | *M*-element vector.

This property is read-only.

Strength of keypoints, specified as one of these values:

- A scalar — Detected keypoints have the same strength. In this case, the object assigns the same `Metric` value to all keypoints.
- An M -element vector — Detected keypoints have different strength values. In this case, the object assigns different `Metric` value to each keypoint. M is the number of keypoints.

Example: `ORBPoints(location, 'Metric', 0.5)`

Data Types: `single`

Count — Number of keypoints

`0` (default) | nonnegative integer

This property is read-only.

Number of keypoints held by the object, specified as a nonnegative integer.

Scale — Scale factor

`[]` (default) | scalar | M -element vector

This property is read-only.

Scale factor, specified as one of these values:

- A scalar — All keypoints are detected at the same level of decomposition. In this case, the object assigns the same `Scale` value to all keypoints.
- An M -element vector — The keypoints are detected at different levels of decomposition. In this case, the object assigns different `Scale` value to each keypoint. M is the number of keypoints.

The scale factor specifies the level of decomposition at which a keypoint is detected.

Example: `ORBPoints(location, 'Scale', 1.2)`

Data Types: `single`

Orientation — Angle of keypoints in radians

`[]` (default) | scalar | M -element vector

This property is read-only.

Angle of keypoints in radians, specified as one of these values:

- A scalar — Detected keypoints are of the same orientation. In this case, the object assigns the same `Orientation` value to all keypoints.
- An M -element vector — Detected keypoints are of different orientation. In this case, the object assigns different `Orientation` value to each keypoint. M is the number of keypoints.

The angle made by a keypoint is defined with reference to the horizontal axis of the image. The coordinate of the keypoint is set as the origin of the axis.

Example: `ORBPoints(location, 'Orientation', 0.7854)`

Data Types: `single` | `double` | `int8` | `int16` | `int32` | `int64` | `uint8` | `uint16` | `uint32` | `uint64`

Object Functions

`isempty` Determine if points object is empty

length	Number of stored points
plot	Plot points
selectStrongest	Select points with strongest metrics
size	Return size of points object
selectUniform	Select uniformly distributed subset of feature points

Examples

Create and Modify Properties of ORBPoints

Read an image into the workspace.

```
I = imread('licensePlates.jpg');
```

Convert the image into a grayscale image.

```
I = im2gray(I);
```

Specify the location of keypoints in the image.

```
location = [400 398; ...  
           485 343; ...  
           274 323; ...  
           274 367; ...  
           241 313; ...  
           302 213];
```

Create an ORBPoints object and display its properties.

```
points = ORBPoints(location)  
  
points =  
  6x1 ORBPoints array with properties:  
  
    Location: [6x2 single]  
    Metric: [6x1 single]  
    Count: 6  
    Scale: [6x1 single]  
    Orientation: [6x1 single]
```

Inspect the Scale and Orientation properties of the ORBPoints object.

```
points.Scale  
  
ans = 6x1 single column vector  
  
    1  
    1  
    1  
    1  
    1  
    1  
  
points.Orientation
```

```
ans = 6x1 single column vector
```

```
0  
0  
0  
0  
0  
0
```

Specify the scale value for each keypoint.

```
scale = [2.1 2.5 2.5 4 2.3 3.9];
```

Specify the angle values for the keypoints as 0.7854 radians.

```
angle = 0.7854;
```

Create an `ORBPoints` object with the keypoints and the updated scale and angle values. The output is an `ORBPoints` object containing keypoints with the modified `Scale` and `Orientation` properties.

```
points = ORBPoints(location, 'Scale',scale, 'Orientation',angle);
```

Inspect the updated `Scale` values.

```
points.Scale
```

```
ans = 6x1 single column vector
```

```
2.1000  
2.5000  
2.5000  
4.0000  
2.3000  
3.9000
```

Inspect the updated `Orientation` values. Since the `Orientation` value is a scalar, the object assigns same value to all keypoints.

```
points.Orientation
```

```
ans = 6x1 single column vector
```

```
0.7854  
0.7854  
0.7854  
0.7854  
0.7854  
0.7854
```

Display the image and plot the ORB keypoints on the image.

```
figure  
imshow(I)  
hold on  
plot(points)
```



Detect and Store ORB Keypoints

Read an image into the workspace.

```
I = imread('cameraman.tif');
```

Use the `detectORBFeatures` function to detect ORB keypoints in the image. The function returns the detected ORB keypoints as an `ORBPoints` object.

```
points = detectORBFeatures(I);
```

Use the `selectUniform` object function to select 10 ORB keypoints. The output of the `selectUniform` object function is an `ORBPoints` object.

```
newPoints = selectUniform(points,10,size(I))
```

```
newPoints =  
10x1 ORBPoints array with properties:
```

```
Location: [10x2 single]  
Metric: [10x1 single]
```

```

Count: 10
Scale: [10x1 single]
Orientation: [10x1 single]

```

Display the location and scale of the selected keypoints on the image.

```

figure
imshow(I)
hold on
plot(newPoints)

```

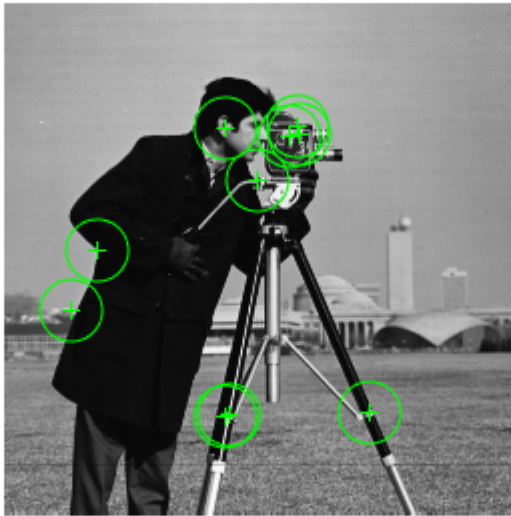

Display the (x, y) coordinates of the selected keypoints.

```

x = newPoints.Location(:,1);
y = newPoints.Location(:,2);
[x y]

```

```

ans = 10x2 single matrix

```

```

147    62
111    63
143    67
127    89
 47   124
 34   154
183   205
113   206
111   207
148    66

```

Display the orientation of the selected keypoints.

```
newPoints.Orientation
```

```
ans = 10x1 single column vector
```

```
5.4682  
0.7888  
5.3084  
6.2443  
2.8221  
3.8440  
6.1212  
6.0344  
4.8840  
5.5535
```

Tips

Although `ORBPoints` can hold many points, it is a scalar object. Therefore, `numel(ORBPoints)` always returns 1. This value can differ from `length(ORBPoints)`, which returns the true number of points held by the object.

References

- [1] Rublee, E., V. Rabaud, K. Konolige, and G. Bradski. "ORB: An Efficient Alternative to SIFT or SURF." In *Proceedings of the 2011 International Conference on Computer Vision*, pp. 2564–2571. Barcelona, Spain: IEEE, 2011.

Extended Capabilities

C/C++ Code Generation

Generate C and C++ code using MATLAB® Coder™.

This function supports C/C++ code generation with the limitations:

- Use in a MATLAB Function block is not supported.

See Also

`extractFeatures` | `detectORBFeatures` | `matchFeatures` | `SURFPoints` | `KAZEPoints` | `BRISKPoints` | `MSERRegions` | `cornerPoints` | `detectHarrisFeatures` | `detectFASTFeatures` | `detectBRISKFeatures` | `detectMinEigenFeatures`

Topics

"Point Feature Types"

"Local Feature Detection and Extraction"

Introduced in R2019a

vision.AlphaBlender

Package: vision

Combine images, overlay images, or highlight selected pixels

Description

The AlphaBlender System object combines two images, overlays one image over another, or highlights selected pixels.

To combine two images, overlay one image over another, or highlight selected pixels:

- 1 Create the `vision.AlphaBlender` object and set its properties.
- 2 Call the object with arguments, as if it were a function.

To learn more about how System objects work, see [What Are System Objects?](#)

Creation

Syntax

```
alphablend = vision.AlphaBlender
alphablend = vision.AlphaBlender(Name,Value)
```

Description

`alphablend = vision.AlphaBlender` creates an alpha blender System object, `alphablend`, which combines two images, overlays one image over another, or highlights selected pixels.

`alphablend = vision.AlphaBlender(Name,Value)` sets properties using one or more name-value pairs. Enclose each property name in quotes. For example, `alphablend = vision.AlphaBlender('Operation','Blend')`

Properties

Unless otherwise indicated, properties are *nontunable*, which means you cannot change their values after calling the object. Objects lock when you call them, and the `release` function unlocks them.

If a property is *tunable*, you can change its value at any time.

For more information on changing property values, see [System Design in MATLAB Using System Objects](#).

Operation — Operation

'Blend' | 'Binary mask' | 'Highlight selected pixels'

Operation, specified as 'Blend', 'Binary mask', or 'Highlight selected pixels'.

Operation	Description
'Blend'	Linearly combine the pixels of one image with the another image.
'Binary mask'	Overwrite the pixel values of one image with the pixel values of another image.
'Highlight selected pixels'	Uses the mask binary image input to determine which pixels are set to the maximum value supported by their data type.

OpacitySource — Source of opacity factor

Property (default) | 'Input port'

Source of opacity factor, specified as 'Property' or 'Input port'. This property applies when you set the Operation property to Blend.

Opacity — Pixel scale value

0.75 (default) | scalar | matrix

Pixel scale value, specified as a scalar or matrix. The object scales each pixel before combining the images. This property applies when you set the OpacitySource property to Property.

Tunable: Yes

MaskSource — Binary mask source

'Property' (default) | 'Input port'

Binary mask source, specified as 'Property' or 'Input port'. This property applies when you set the Operation property to Binary mask

Mask — Overwrite scalar

1 (default) | 0 | binary scalar | matrix of binary scalars

Overwrite scalar, specified as 0 or 1 for every pixel, or a matrix of 0s and 1s. This property applies when you set the MaskSource property to Property.

Tunable: Yes

LocationSource — Source for upper-left location

'Property' (default) | 'Input port'

Source of location of the upper-left corner of second input image

Source for the upper-left corner location of the second input image, specified as Property or Input port.

Location — Location

[1 1] | two-element vector

Location of the upper-left corner of the second input image relative to the location of the first input image, specified as a two-element vector in the format [x y]. This property applies when you set the LocationSource property to Property.

See “Coordinate Systems” for a discussion on pixel coordinates and spatial coordinates, which are the two main coordinate systems used in the Computer Vision Toolbox.

Tunable: Yes

Fixed-Point Properties

RoundingMethod — Rounding method

'Floor' (default) | 'Convergent' | 'Floor' | ...

Rounding method, specified as 'Ceiling', 'Convergent', 'Floor', 'Nearest', 'Round', 'Simplest', 'Zero', or 'Floor'

OverflowAction — Overflow action

'Wrap' (default) | 'Saturate'

Overflow action for fixed-point operations, specified as 'Wrap' or 'Saturate'.

OpacityDataType — Opacity word and fraction lengths

'Same word length as input' (default) | 'Custom'

Opacity word and fraction lengths for fixed-point operations, specified as 'Same word length as input' or 'Custom'.

CustomOpacityDataType — Opacity word and fraction lengths

numericity([],16) (default) | unscaled numericity object

Opacity word and fraction lengths factor for fixed-point operations, specified as an unscaled numericity object with a Signedness of Auto. This property applies when you set the OpacityDataType property to Custom

ProductDataType — Product word and fraction lengths

'Custom' (default) | 'Same as first input'

Product word and fraction lengths, specified as 'Custom' or 'Same as first input'.

CustomProductDataType — Product word and fraction lengths

numericity([],32,10) (default) | scaled numericity object

Product word and fraction lengths, specified as a scaled numericity object with a 'Signedness' of 'Auto'. This property applies when you set the 'ProductDataType' property to 'Custom'

AccumulatorDataType — Accumulator word and fraction lengths

'Same as product' (default) | 'Custom'

Accumulator word and fraction lengths, specified as 'Same as product', 'Same as first input', or 'Custom'.

CustomAccumulatorDataType — Accumulator word and fraction lengths

numericity([],32,10) (default) | scaled numericity object

Accumulator word and fraction lengths, specified as a scaled numericity object with a 'Signedness' of 'Auto'.

OutputDataType — Output word and fraction lengths

'Same as product' (default) | 'Custom'

Output word and fraction lengths, specified as 'Same as first input' or 'Custom'.

CustomOutputDataType — Output word and fraction lengths

numericType([],32,10) (default) | scaled numericType object

Output word and fraction lengths, specified as a scaled numericType object with a 'Signedness' of 'Auto'.

Usage**Syntax**

```
ab = alphablend(I1,I2)
ab = alphablend(I1,I2,opacity)
ab = alphablend(I1,I2,mask)
ab = alphablend(I1,mask)
ab = alphablend(I1,I2, ____,location)
```

Description

`ab = alphablend(I1,I2)` returns a alpha blender object that blends images I1 and I2.

`ab = alphablend(I1,I2,opacity)` uses the `opacity` input to combine pixel values of I1 and I2. To use the `opacity` input, you must set the `Operation` property to 'Blend' and the `OpacitySource` property to 'Input port'.

`ab = alphablend(I1,I2,mask)` uses the `mask` input to overlay I1 over I2. To use the `mask` input with an overlay, you must set the `Operation` property to 'Binary mask' and the `MaskSource` property to 'Input port'.

`ab = alphablend(I1,mask)` uses the `mask` input to determine which pixels in I1 are set to the maximum value supported by their data type. To use the `mask` input with an overlay, you must set the `Operation` property to 'Highlight selected pixels' and the `MaskSource` property to 'Input port'.

`ab = alphablend(I1,I2, ____,location)` additionally sets the upper-left corner location for I2. To use the `location` input, you must set the `LocationSource` property to 'Input port'.

Input Arguments**I1 — Input image***M-by-N-by-3* truecolor | *M-by-N* 2-D grayscale image

Input image, specified in truecolor or 2-D grayscale.

Data Types: single | double | int16 | uint8 | uint16

I2 — Input image*M-by-N-by-3* truecolor | *M-by-N* 2-D grayscale image

Input image, specified in truecolor or 2-D grayscale.

Data Types: single | double | int16 | uint8 | uint16

opacity — Scale

scalar | matrix

Pixel scale value, specified as a scalar or matrix. The object scales each pixel before combining the images.

mask — Overwrite scalar

binary scalar | matrix of binary scalars

Overwrite scalar, specified as 0 or 1 for every pixel, or a matrix of 0s and 1s.

Location — Location

two-element vector

Location of the upper-left corner of the second input image relative to the location of the first input image, specified as a two-element vector in the format [x y].

Tunable: Yes

Output Arguments

aIphabIend — Blended output image

M-by-*N*-by-3 truecolor | *M*-by-*N* 2-D grayscale image

Output blended image, returned as a combined image, overlaid image, or an image with selected pixels highlighted.

Object Functions

To use an object function, specify the System object as the first input argument. For example, to release system resources of a System object named `obj`, use this syntax:

```
release(obj)
```

Common to All System Objects

step	Run System object algorithm
release	Release resources and allow changes to System object property values and input characteristics
reset	Reset internal states of System object

Examples

Blend Two Images

Display the two images.

```
I1 = im2single(imread('blobs.png'));
I2 = im2single(imread('circles.png'));
subplot(1,2,1);
imshow(I1);
subplot(1,2,2);
imshow(I2);
```

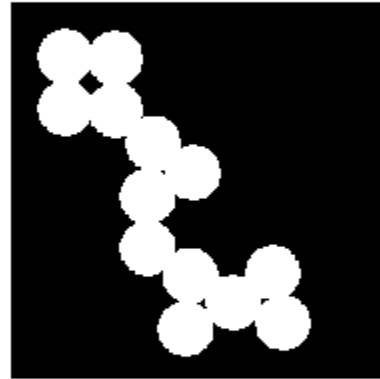
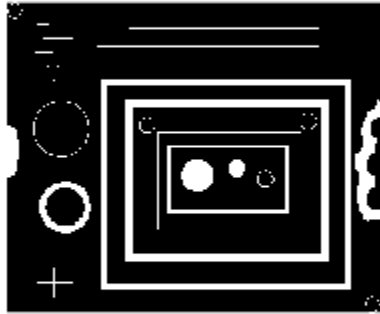

Blend the two images and display the result.

```
blender = vision.AlphaBlender;  
J = blender(I1,I2);  
figure;  
imshow(J);
```

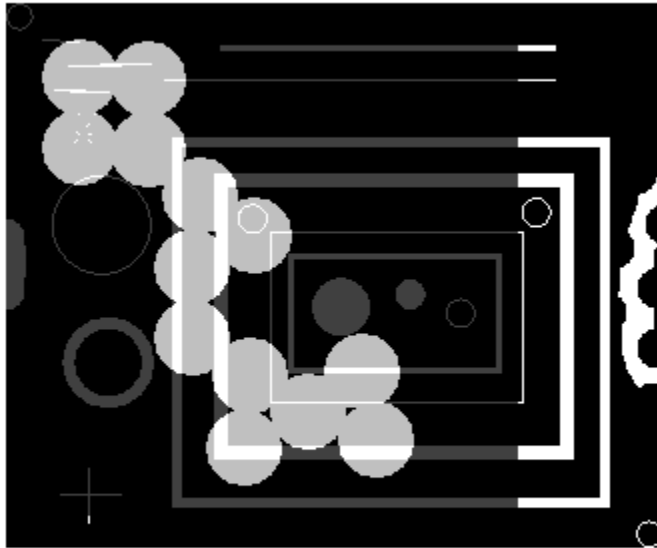

Extended Capabilities

C/C++ Code Generation

Generate C and C++ code using MATLAB® Coder™.

Usage notes and limitations:

- See “System Objects in MATLAB Code Generation” (MATLAB Coder).

See Also

`insertText`

Introduced in R2012a

vision.BinaryFileReader

Package: vision

Read video data from binary files

Description

The `BinaryFileReader` object reads video data from binary files.

To read a binary file:

- 1 Create the `vision.BinaryFileReader` object and set its properties.
- 2 Call the object with arguments, as if it were a function.

To learn more about how System objects work, see [What Are System Objects?](#)

Creation

Syntax

```
bFileReader = vision.BinaryFileReader  
bFileReader = vision.BinaryFileReader(Name,Value)  
bFileReader = vision.BinaryFileReader(file,Name,Value)
```

Description

`bFileReader = vision.BinaryFileReader` returns a binary file reader object, `bFileReader`, that reads binary video data from the specified file in I420 Four Character Code (FOURCC) video format.

`bFileReader = vision.BinaryFileReader(Name,Value)` sets properties using one or more name-value pairs. Enclose each property name in quotes. For example, `bFileReader = vision.BinaryFileReader('Filename','vipmen.bin')`

`bFileReader = vision.BinaryFileReader(file,Name,Value)` returns a binary file reader System object, `bFileReader`, with the `Filename` property set to `file` and other specified properties set to the specified values.

Properties

Unless otherwise indicated, properties are *nontunable*, which means you cannot change their values after calling the object. Objects lock when you call them, and the `release` function unlocks them.

If a property is *tunable*, you can change its value at any time.

For more information on changing property values, see [System Design in MATLAB Using System Objects](#).

Filename — File name

vipmen.bin (default) | character vector

File name, specified as a character vector. The full path for the file needs to be specified only if the file is not on the MATLAB path.

VideoFormat — Video file format

'Four character codes' (default) | 'Custom'

Video file format, specified as 'Four character codes' or 'Custom'.

FourCharCode — Four Character Code video format

binary file format

Four Character Code video format, specified as one of the available video formats. For more information on four character codes, see <https://www.fourcc.org>. This property applies when you set the VideoFormat property to 'Four character codes'.

BitstreamFormat — Format of data

'Planar' (default) | 'Packed'

Format of data, specified as 'Planar' or 'Packed'. This property applies when you set the VideoFormat property to Custom.

OutputSize — Size of output*M*-by-*N* matrix

Size of output, specified as an *M*-by-*N* matrix. This property applies when you set the BitstreamFormat property to 'Packed'.

VideoComponentCount — Number of video components in video stream

3 (default) | 1 | 2 | 4

Number of video components in video stream, specified as 1, 2, 3 or 4. This number corresponds to the number of video component outputs. This property applies when you set the VideoFormat property to 'Custom'.

VideoComponentBits — Bit size of video components

[8 8 8] (default) | vector

Bit size of video components, specified as an integer vector of length *N*, where *N* is the value of the VideoComponentCount property. This property applies when you set the VideoFormat property to 'Custom'.

VideoComponentSizes — Size of video components[120 160; 60 80; 60 80] (default) | *N*-by-2 array

Size of video components, specified as an *N*-by-2 array, where *N* is the value of the VideoComponentCount property. Each row of the matrix corresponds to the size of that video component, with the first element denoting the number of rows and the second element denoting the number of columns. This property applies when you set the VideoFormat property to 'Custom' and the BitstreamFormat property to 'Planar'.

VideoComponentOrder — Order of video components[1 2 3] (default) | 1-by-*N* vector

Order of video components, specified as a 1-by- N vector. This property must be set to a vector of length N , where N is set according to how you set the `BitStreamFormat` property. When you set the `BitStreamFormat` property to 'Planar', you must set N equal to the value of the `VideoComponentCount` property. Otherwise, you can set N equal to or greater than the value of the `VideoComponentCount` property. This property applies when you set the `VideoFormat` property to 'Custom'.

InterlacedVideo — Interlaced video status

false (default) | true

Interlaced video status, specified as true or false. Set this property to true if the video stream represents interlaced video data. This property applies when you set the `VideoFormat` property to 'Custom'.

LineOrder — Fill binary file format

'Top line first' (default) | 'Bottom line first'

Fill binary file format, specified as 'Top line first', or 'Bottom line first'. If you set this property to 'Top line first', the first row of the video frame gets filled first. If you set this property to 'Bottom line first', the last row of the video frame gets filled first.

SignedData — Signed data

false (default) | true

Signed data, specified as true or false. Set this property to true for signed input data. This property applies when you set the `VideoFormat` property to 'Custom'

ByteOrder — Byte order

'Little endian' (default) | 'Big endian'

Byte order, specified as 'Little endian' or 'Big endian'. This property applies when you set the `VideoFormat` property to 'Custom'.

PlayCount — Play count

1 (default) | positive integer

Play count for the number of times to play the file, specified as a positive integer.

Usage

Syntax

```
[Y,Cb,Cr] = bFileReader()  
Y = bFileReader()  
[Y,Cb,Cr,Alpha] = bFileReader()  
[ ____,EOF] = bFileReader()
```

Description

`[Y,Cb,Cr] = bFileReader()` reads the luminance, Y and chrominance, Cb and Cr components of a video stream from the specified binary file when you set the `VideoFormat` property to 'Four character codes'. Alternatively, it reads the values when you set the `VideoFormat` property to 'Custom' and the `VideoComponentCount` property to 2.

`Y = bFileReader()` reads the video component `Y` from the binary file when you set the `VideoFormat` property to 'Custom' and the `VideoComponentCount` property to 1.

`[Y,Cb,Cr,Alpha] = bFileReader()` additionally reads the `Alpha` when you set the `VideoFormat` property to 'Custom' and the `VideoComponentCount` property to 4.

`[____,EOF] = bFileReader()` also returns the end-of-file indicator, `EOF`. `EOF` is set to `true` when the output contains the last video frame in the file.

Output Arguments

Y — Luminance value

M-by-*N* matrix

Luminance value, returned as an *M*-by-*N* matrix.

Cb — Chrominance value

M-by-*N* matrix

Chrominance value, returned as an *M*-by-*N* matrix.

Cr — Chrominance value

M-by-*N* matrix

Chrominance value, returned as an *M*-by-*N* matrix.

Alpha — Transparency

scalar

Transparency value, returned as a scalar in the range [0,1].

Object Functions

To use an object function, specify the System object as the first input argument. For example, to release system resources of a System object named `obj`, use this syntax:

```
release(obj)
```

Specific to vision.BinaryFileReader

`isDone` End-of-file status (logical)

Common to All System Objects

`step` Run System object algorithm

`release` Release resources and allow changes to System object property values and input characteristics

`reset` Reset internal states of System object

Examples

Read Binary Video File and Play Back on Screen

Create a binary file reader and video player object.

```
hbfr = vision.BinaryFileReader();  
hvp = vision.VideoPlayer;
```

Use the while loop to play the default video.

```
while ~isDone(hbfr)  
y = hbfr();  
hvp(y);  
end
```

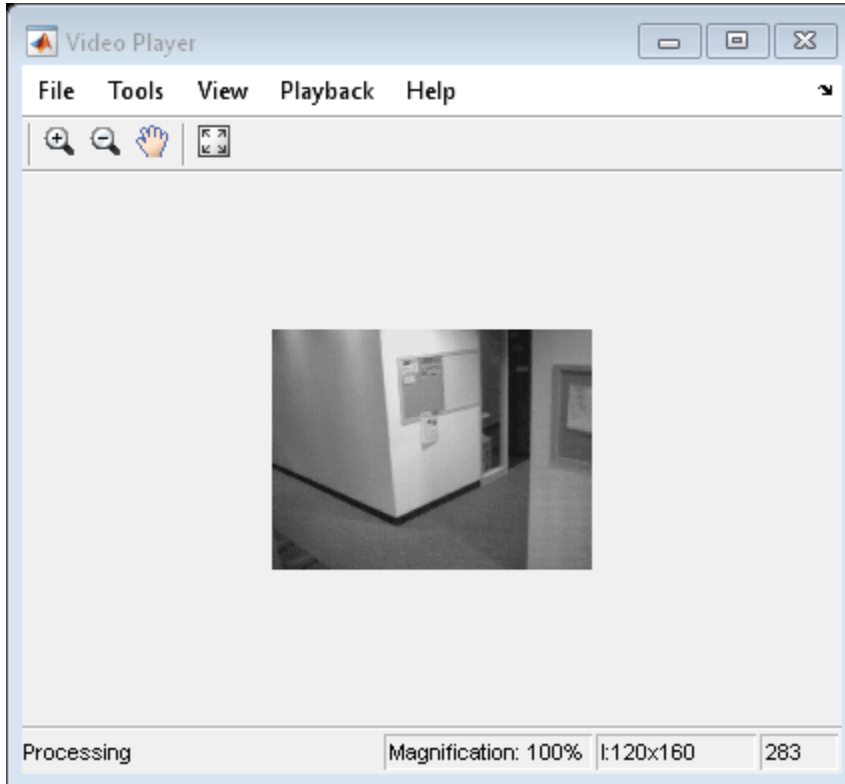

Close the input file and the video display.

```
release(hbfr);  
release(hvp);
```

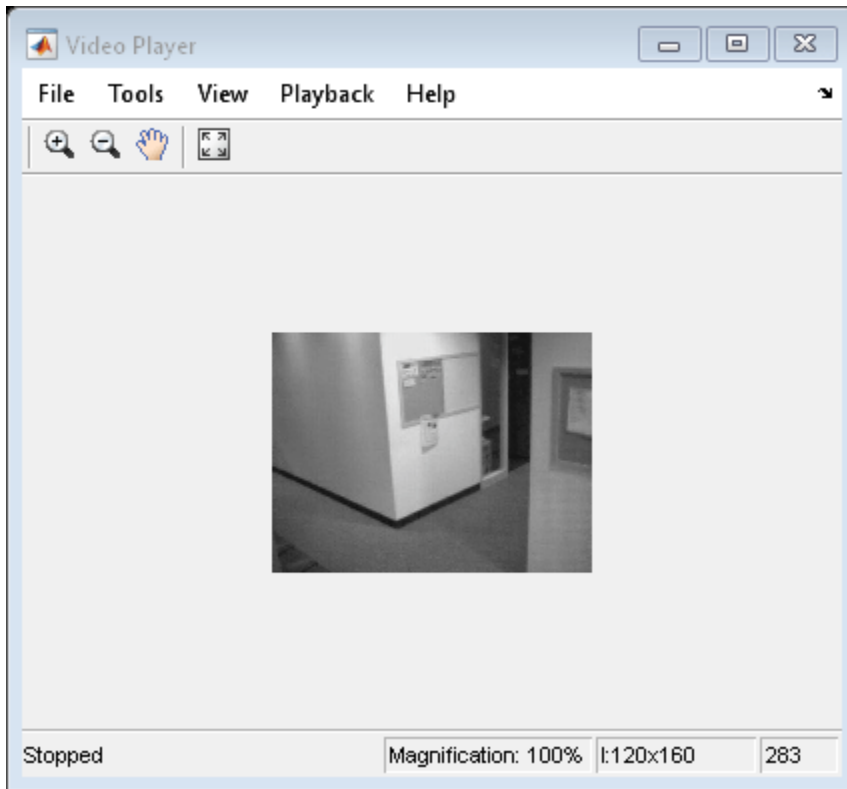

See Also

[vision.VideoFileReader](#) | [vision.BinaryFileWriter](#)

Introduced in R2012a

vision.BinaryFileWriter

Package: vision

Write binary video data to files

Description

The `BinaryFileWriter` object writes binary video data to files.

To write binary data to a file:

- 1 Create the `vision.BinaryFileWriter` object and set its properties.
- 2 Call the object with arguments, as if it were a function.

To learn more about how System objects work, see [What Are System Objects?](#)

Creation

Syntax

```
bFileWriter = vision.BinaryFileWriter  
bFileWriter = vision.BinaryFileWriter(Name,Value)
```

Description

`bFileWriter = vision.BinaryFileWriter` returns a binary writer object that writes binary video data to an output file, `output.bin` in the I420 Four Character Code format.

`bFileWriter = vision.BinaryFileWriter(Name,Value)` sets properties using one or more name-value pairs. Enclose each property name in quotes. For example, `bFileWriter = vision.BinaryFileWriter('Filename','output.bin')`

Properties

Unless otherwise indicated, properties are *nontunable*, which means you cannot change their values after calling the object. Objects lock when you call them, and the `release` function unlocks them.

If a property is *tunable*, you can change its value at any time.

For more information on changing property values, see [System Design in MATLAB Using System Objects](#).

Filename — File name

`output.bin` (default) | character vector

File name, specified as a character vector.

VideoFormat — Video file format

'Four character codes' (default) | 'Custom'

Video file format, specified as 'Four character codes' or 'Custom'.

FourCharacterCode — Four Character Code video format

binary file format

Four Character Code video format, specified as one of the available video formats. For more information on four character codes, see <https://www.fourcc.org>. This property applies when you set the VideoFormat property to 'Four character codes'.

BitstreamFormat — Format of data

'Planar' (default) | 'Packed'

Format of data, specified as 'Planar' or 'Packed'. This property applies when you set the VideoFormat property to Custom.

VideoComponentCount — Number of video components in video stream

3 (default) | 1 | 2 | 4

Number of video components in video stream, specified as 1, 2, 3 or 4. This number corresponds to the number of video component outputs. This property applies when you set the VideoFormat property to 'Custom'.

VideoComponentBitsSource — Size of video components format

'Auto' (default) | 'Property'

Size of video components format, specified as 'Auto' or 'Property'. If this property is set to 'Auto', each component will have a VideoComponentBits property. This property applies when you set the VideoFormat property to 'Custom'.

VideoComponentBits — Bit size of video components

[8 8 8] (default) | vector

Bit size of video components, specified as an integer vector of length N , where N is the value of the VideoComponentCount property. This property applies when you set the VideoFormat property to 'Custom'.

VideoComponentOrder — Order of video components

[1 2 3] (default) | 1-by- N vector

Order of video components, specified as a 1-by- N vector. This property must be set to a vector of length N , where N is set according to how you set the BitstreamFormat property. When you set the BitstreamFormat property to 'Planar', you must set N equal to the value of the VideoComponentCount property. Otherwise, you can set N equal to or greater than the value of the VideoComponentCount property. This property applies when you set the VideoFormat property to 'Custom'.

InterlacedVideo — Interlaced video status

false (default) | true

Interlaced video status, specified as true or false. Set this property to true if the video stream represents interlaced video data. This property applies when you set the VideoFormat property to 'Custom'.

LineOrder — Fill binary file format

'Top line first' (default) | 'Bottom line first'

Fill binary file format, specified as 'Top line first', or 'Bottom line first'. If you set this property to 'Top line first', the first row of the video frame gets filled first. If you set this property to 'Bottom line first', the last row of the video frame gets filled first.

SignedData — Signed data

false (default) | true

Signed data, specified as true or false. Set this property to true for signed input data. This property applies when you set the VideoFormat property to 'Custom'

ByteOrder — Byte order

'Little endian' (default) | 'Big endian'

Byte order, specified as 'Little endian' or 'Big endian'. This property applies when you set the VideoFormat property to 'Custom'.

Usage**Syntax**

bFileWriter(Y,Cb,Cr)
bFileWriter(Y)
bFileWriter(Y,Cb)
bFileWriter(Y,Cb,Cr)
bFileWriter(Y,Cb,Cr,Alpha)

Description

bFileWriter(Y,Cb,Cr) writes one frame of video to the specified output file. Y , Cb, Cr represent the luma (Y) and chroma (Cb and Cr) components of a video stream. This option applies when you set the VideoFormat property to 'Four character codes'.

bFileWriter(Y) writes video component Y to the output file when the VideoFormat property is set to 'Custom' and the VideoComponentCount property is set to 1.

bFileWriter(Y,Cb) writes video components Y and Cb to the output file when the VideoFormat property is 'Custom' and the VideoComponentCount property is set to 2.

bFileWriter(Y,Cb,Cr) writes video components Y , Cb and Cr to the output file when the VideoFormat property is set to 'Custom' and the VideoComponentCount property is set to 3.

bFileWriter(Y,Cb,Cr,Alpha) writes video components Y , Cb, Cr and Alpha to the output file when the VideoFormat property is set to 'Custom', and the VideoComponentCount property is set to 4.

Input Arguments**Y — Luminance value**

M-by-*N* matrix

Luminance value, returned as an *M*-by-*N* matrix.

Cb — Chrominance value

M-by-*N* matrix

Chrominance value, returned as an M -by- N matrix.

Cr — Chrominance value

M -by- N matrix

Chrominance value, returned as an M -by- N matrix.

Alpha — Transparency

scalar

Transparency value, returned as a scalar in the range [0,1].

Object Functions

To use an object function, specify the System object as the first input argument. For example, to release system resources of a System object named `obj`, use this syntax:

```
release(obj)
```

Common to All System Objects

`step` Run System object algorithm

`release` Release resources and allow changes to System object property values and input characteristics

`reset` Reset internal states of System object

Examples

Write Video Data to a Binary File

Set the output file name and create binary file reader and writer objects.

```
filename = fullfile(tempdir, 'output.bin');
bFileReader = vision.BinaryFileReader;
bFileWriter = vision.BinaryFileWriter(filename);
```

Write to the file.

```
while ~isDone(bFileReader)
    [y,cb,cr] = bFileReader();
    bFileWriter(y,cb,cr);
end
```

Close the files.

```
release(bFileReader);
release(bFileWriter);
```

See Also

`vision.VideoFileReader` | `vision.BinaryFileReader`

Introduced in R2012a

vision.BlobAnalysis

Package: vision

Properties of connected regions

Description

To compute statistics for connected regions in a binary image

To track a set of points:

- 1 Create the `vision.BlobAnalysis` object and set its properties.
- 2 Call the object with arguments, as if it were a function.

To learn more about how System objects work, see [What Are System Objects?](#)

Creation

Syntax

```
Hblob = vision.BlobAnalysis  
Hblob = vision.BlobAnalysis(Name,Value)
```

Description

`Hblob = vision.BlobAnalysis` returns a blob analysis object, `H`, used to compute statistics for connected regions in a binary image.

`Hblob = vision.BlobAnalysis(Name,Value)` sets properties using one or more name-value pairs. Enclose each property name in quotes. For example, `Hblob = vision.BlobAnalysis('AreaOutputPort',true)`

Properties

Unless otherwise indicated, properties are *nontunable*, which means you cannot change their values after calling the object. Objects lock when you call them, and the `release` function unlocks them.

If a property is *tunable*, you can change its value at any time.

For more information on changing property values, see [System Design in MATLAB Using System Objects](#).

AreaOutputPort — Return blob area

true (default) | false

Return blob area, specified as true or false.

CentroidOutputPort — Return coordinates of blob centroids

true (default) | false

Return coordinates of blob centroids, specified as `true` or `false`.

BoundingBoxOutputPort — Return coordinates of bounding boxes

`true` (default) | `false`

Return coordinates of bounding boxes, specified as `true` or `false`.

MajorAxisLengthOutputPort — Return vector whose values represent lengths of ellipses' major axes

`false` (default) | `true`

Return vector whose values represent lengths of ellipses' major axes, specified as `true` or `false`. Set this property to `true` to output a vector whose values represent the lengths of the major axes of the ellipses that have the same normalized second central moments as the labeled regions. This property applies when you set the `OutputDataType` property to `double` or `single`.

MinorAxisLengthOutputPort — Return vector whose values represent lengths of ellipses' minor axes

`false` (default) | `true`

Return vector whose values represent lengths of ellipses' minor axes, specified as `true` or `false`. Set this property to `true` to output a vector whose values represent the lengths of the minor axes of the ellipses that have the same normalized second central moments as the labeled regions. This property is available when the `OutputDataType` property is `double` or `single`.

OrientationOutputPort — Return vector whose values represent angles between ellipses' major axes and x-axis

`false` (default) | `true`

Return vector whose values represent angles between ellipses' major axes and x-axis, specified as `true` or `false`. Set this property to `true` to output a vector whose values represent the angles between the major axes of the ellipses and the x-axis. This property applies when you set the `OutputDataType` property to `double` or `single`.

EccentricityOutputPort — Return vector whose values represent ellipses' eccentricities

`false` (default) | `true`

Return vector whose values represent ellipses' eccentricities, specified as `true` or `false`. Set this property to `true` to output a vector whose values represent the eccentricities of the ellipses that have the same second moments as the region. This property applies when you set the `OutputDataType` property to `double` or `single`.

EquivalentDiameterSquaredOutputPort — Return vector whose values represent equivalent diameters squared

`false` (default) | `true`

Return vector whose values represent equivalent diameters squared, specified as `true` or `false`. Set this property to `true` to output a vector whose values represent the equivalent diameters squared.

ExtentOutputPort — Return vector whose values represent results of dividing blob areas by bounding box areas

`false` (default) | `true`

Return vector whose values represent results of dividing blob areas by bounding box areas, specified as `true` or `false`.

PerimeterOutputPort — Return vector whose values represent estimates of blob perimeter lengths`false (default) | true`

Return vector whose values represent estimates of blob perimeter lengths, specified as `true` or `false`.

OutputDataType — Output data type of statistics`double (default) | single | Fixed point`

Output data type of statistics, specified as `double`, `single`, or `Fixed point`. Area and bounding box outputs are always an `int32` data type. Major axis length, Minor axis length, Orientation and Eccentricity do not apply when you set this property to `Fixed point`.

Connectivity — Connected pixels`8 (default) | 4`

Connected pixels, specified as 4 or 8.

LabelMatrixOutputPort — Maximum number of labeled regions in each input image`50 (default) | positive scalar integer`

Maximum number of labeled regions in each input image, specified as a positive scalar integer. The maximum number of blobs the object outputs depends on both the value of this property, and on the size of the input image. The number of blobs the object outputs may be limited by the input image size.

MinimumBlobArea — Minimum blob area in pixels`0 (default) | positive scalar integer`

Minimum blob area in pixels, specified as positive scalar integer.

Tunable: Yes

MaximumBlobArea — Maximum blob area in pixels`intmax('uint32') (default) | integer`

Maximum blob area in pixels, specified as an integer.

Tunable: Yes

ExcludeBorderBlobs — Exclude blobs that contain at least one image border pixel`false (default) | true`

Exclude blobs that contain at least one image border pixel, specified as `true` or `false`.

MaximumCount — Maximum number of labeled regions in each input image`50 (default) | positive scalar integer`

Maximum number of labeled regions in each input image, specified as a positive scalar integer. The maximum number of blobs the object outputs depends on both the value of this property, and on the size of the input image. The number of blobs the object outputs may be limited by the input image size

Fixed-Point Properties

RoundingMethod — Rounding method for fixed-point operations

'Floor' (default) | 'Ceiling' | 'Convergent' | 'Nearest' | 'Round' | 'Simplest' | 'Zero'

Rounding method for fixed-point operations, specified as 'Floor', 'Ceiling', 'Convergent', 'Nearest', 'Round', 'Simplest', or 'Zero'.

OverflowAction — Action to take when integer input is out-of-range

'Wrap' (default) | 'Saturate'

Action to take when integer input is out-of-range, specified as 'Wrap' or 'Saturate'.

ProductDataType — Product data type

'Same as input' (default) | 'Custom'

Product data type, specified as 'Same as input' or 'Custom'.

CustomProductDataType — Product word and fraction lengths

numericType(true,32,30) (default) | scaled numericType object

Product word and fraction lengths, specified as a scaled numericType object. This property applies only when you set the AccumulatorDataType property to 'Custom'.

AccumulatorDataType — Data type of accumulator

'Same as product' (default) | 'Same as input' | 'Custom'

Data type of accumulator, specified as 'Same as product', 'Same as input', or 'Custom'.

CustomAccumulatorDataType — Accumulator word and fraction lengths

numericType(true,32,30) (default) | scaled numericType object

Accumulator word and fraction lengths, specified as a scaled numericType object. This property applies only when you set the AccumulatorDataType property to 'Custom'.

Usage

Syntax

```
[area,centroid,bbox] = Hblob(bw)
[ ____,majoraxis] = Hblob(bw)
[ ____,minoraxis] = Hblob(bw)
[bw ____,orientation] = Hblob(bw)
[ ____,eccentricity] = Hblob(bw)
[ ____,EQDIASQ] = Hblob(bw)
[ ____,EXTENT] = Hblob(bw)
[ ____,perimeter] = Hblob(bw)
[ ____,label] = Hblob(bw)
```

Description

[area,centroid,bbox] = Hblob(bw) returns the area, centroid, and the bounding box of the blobs when the AreaOutputPort, CentroidOutputPort and BoundingBoxOutputPort properties are set to true. These are the only properties that are set to true by default. If you set any

additional properties to `true`, the corresponding outputs follow the `area`, `centroid`, and `bbox` outputs.

[`___`, `majoraxis`] = `Hblob(bw)` computes the major axis length `majoraxis` of the blobs found in input binary image `bw` when you set the `MajorAxisLengthOutputPort` property to `true`.

[`___`, `minoraxis`] = `Hblob(bw)` computes the minor axis length `minoraxis` of the blobs found in input binary image `bw` when you set the `MinorAxisLengthOutputPort` property to `true`.

[`bw` `___`, `orientation`] = `Hblob(bw)` computes the orientation of the blobs found in input binary image `bw` when you set the `OrientationOutputPort` property to `true`.

[`___`, `eccentricity`] = `Hblob(bw)` computes the eccentricity of the blobs found in input binary image `bw` when you set the `EccentricityOutputPort` property to `true`.

[`___`, `EQDIASQ`] = `Hblob(bw)` computes the equivalent diameter squared `EQDIASQ` of the blobs found in input binary image `bw` when you set the `EquivalentDiameterSquaredOutputPort` property to `true`.

[`___`, `EXTENT`] = `Hblob(bw)` computes the `EXTENT` of the blobs found in input binary image `bw` when the `ExtentOutputPort` property is set to `true`.

[`___`, `perimeter`] = `Hblob(bw)` computes the perimeter of the blobs found in input binary image `bw` when you set the `PerimeterOutputPort` property to `true`.

[`___`, `label`] = `Hblob(bw)` returns a label matrix `label` of the blobs found in input binary image `bw` when you set the `LabelMatrixOutputPort` property to `true`.

Input Arguments

bw — Binary image

vector | matrix

Binary image, specified as a vector or matrix.

Output Arguments

area — Number of pixels in labeled regions

vector

Number of pixels in labeled regions, specified as a vector

centroid — Centroid coordinates

M-by-2 matrix.

Centroid coordinates, specified as an *M*-by-2 matrix. *M* is the number of blobs.

bbox — Bounding box coordinates

M-by-4 matrix

M-by-4 matrix in the format [*x* *y* *width* *height*], where *M* represents the number of blobs and [*x*,*y*] represents the upper-left corner of the bounding box.

majoraxis — Lengths of major axes of ellipses

vector

Lengths of major axes of ellipses, specified as a vector.

minoraxis — Lengths of minor axes of ellipses

vector

Lengths of minor axes of ellipses, specified as a vector.

orientation — Angles between the major axes of the ellipses and the x-axis

vector

Angles between the major axes of the ellipses and the x-axis, specified as a vector.

eccentricity — Eccentricities of the ellipses

vector

Eccentricities of the ellipses, specified as a vector

EQDIASQ — Equivalent diameter squared

vector

Equivalent diameter squared, specified as a vector.

extent — Ratio between area and bounding box

vector

Ratio between area and bounding box, specified as a vector. The vector contains the results of dividing the areas of the blobs by the area of their bounding boxes

perimeter — Estimate of the perimeter length

vector

Estimate of the perimeter length, specified as a vector. The vector contains an estimate of the perimeter length, in pixels, for each blob.

label — Label matrix

matrix

Label matrix, specified as a matrix.

Object Functions

To use an object function, specify the System object as the first input argument. For example, to release system resources of a System object named `obj`, use this syntax:

```
release(obj)
```

Common to All System Objects

step	Run System object algorithm
release	Release resources and allow changes to System object property values and input characteristics
reset	Reset internal states of System object

Examples

Find Centroid of Blob

Create the blob analysis object.

```
hBlob = vision.BlobAnalysis('AreaOutputPort',false,'BoundingBoxOutputPort',false);
```

Create the blob.

```
img = logical([0 0 0 0 0 0; ...  
              0 1 1 1 1 0; ...  
              0 1 1 1 1 0; ...  
              0 1 1 1 1 0; ...  
              0 0 0 0 0 0]);
```

Find the coordinates for the centroid.

```
centroid = hBlob(img);
```

Extended Capabilities

C/C++ Code Generation

Generate C and C++ code using MATLAB® Coder™.

Usage notes and limitations:

- See “System Objects in MATLAB Code Generation” (MATLAB Coder).

See Also

[graythresh](#) | [multithresh](#)

Topics

“Cell Counting”

Introduced in R2012a

vision.BlockMatcher

Package: vision

Estimate motion between images or video frames

Description

To estimate motion between images or video frames.

- 1 Create the `vision.BlockMatcher` object and set its properties.
- 2 Call the object with arguments, as if it were a function.

To learn more about how System objects work, see [What Are System Objects?](#)

Creation

Syntax

```
blkMatcher = vision.BlockMatcher
blkMatcher = vision.BlockMatcher(Name,Value)
```

Description

`blkMatcher = vision.BlockMatcher` returns an object, `blkMatcher`, that estimates motion between two images or two video frames. The object performs this estimation using a block matching method by moving a block of pixels over a search region.

`blkMatcher = vision.BlockMatcher(Name,Value)` sets properties using one or more name-value pairs. Enclose each property name in quotes. For example, `blkMatcher = vision.BlockMatcher('ReferenceFrameSource','Input port')`

Properties

Unless otherwise indicated, properties are *nontunable*, which means you cannot change their values after calling the object. Objects lock when you call them, and the `release` function unlocks them.

If a property is *tunable*, you can change its value at any time.

For more information on changing property values, see [System Design in MATLAB Using System Objects](#).

ReferenceFrameSource — Reference frame source

'Property' (default) | 'Input port'

Reference frame source, specified as 'Input port' or 'Property'. When you set the `ReferenceFrameSource` property to 'Input port', a reference frame input must be specified to the `step` method of the block matcher object.

ReferenceFrameDelay — Number of frames between reference and current frames`1 (default) | scalar integer`

Number of frames between reference and current frames, specified as a scalar integer greater than or equal to zero. This property applies when you set the ReferenceFrameSource property to 'Property'.

SearchMethod — Best match search method`'Exhaustive' (default) | 'Three-step'`

Best match search method, specified as 'Exhaustive' or 'Three-step'. Specify how to locate the block of pixels in frame $k+1$ that best matches the block of pixels in frame k . If you set this property to 'Exhaustive', the block matcher object selects the location of the block of pixels in frame $k+1$. The block matcher does so by moving the block over the search region one pixel at a time, which is computationally expensive.

If you set this property to 'Three-step', the block matcher object searches for the block of pixels in frame $k+1$ that best matches the block of pixels in frame k using a steadily decreasing step size. The object begins with a step size approximately equal to half the maximum search range. In each step, the object compares the central point of the search region to eight search points located on the boundaries of the region and moves the central point to the search point whose values is the closest to that of the central point. The object then reduces the step size by half, and begins the process again. This option is less computationally expensive, though sometimes it does not find the optimal solution.

BlockSize — Size of block in pixels`[17 17] (default) | two-element vector`

Size of block, specified in pixels as a two-element vector.

MaximumDisplacement — Maximum displacement search`[7 7] (default) | two-element vector`

Maximum displacement search, specified as a two-element vector. Specify the maximum number of pixels that any center pixel in a block of pixels can move, from image to image or from frame to frame. The block matcher object uses this property to determine the size of the search region.

MatchCriteria — Match criteria between blocks`'Mean square error (MSE)' (default) | 'Mean absolute difference (MAD)'`

Match criteria between blocks, specified as 'Mean square error (MSE)' or 'Mean absolute difference (MAD)'.

OutputValue — Motion output form`'Magnitude-squared' (default) | 'Horizontal and vertical components in complex form'`

Motion output form, specified as 'Magnitude-squared' or 'Horizontal and vertical components in complex form'.

Overlap — Input image subdivision overlap`[0 0] (default) | two-element vector`

Input image subdivision overlap, specified in pixels as a two-element vector.

Fixed-Point Properties

RoundingMethod — Rounding method for fixed-point operations

'Floor' (default) | 'Ceiling' | 'Convergent' | 'Nearest' | 'Round' | 'Simplest' | 'Zero'

Rounding method for fixed-point operations, specified as 'Floor', 'Ceiling', 'Convergent', 'Nearest', 'Round', 'Simplest', or 'Zero'.

OverflowAction — Action to take when integer input is out-of-range

'Wrap' (default) | 'Saturate'

Action to take when integer input is out-of-range, specified as 'Wrap' or 'Saturate'.

ProductDataType — Product data type

'Same as input' (default) | 'Custom'

Product data type, specified as 'Same as input' or 'Custom'.

CustomProductDataType — Product word and fraction lengths

numericType(true,32,30) (default) | scaled numericType object

Product word and fraction lengths, specified as a scaled numericType object. This property applies only when you set the AccumulatorDataType property to 'Custom'.

AccumulatorDataType — Data type of accumulator

'Same as product' (default) | 'Same as input' | 'Custom'

Data type of accumulator, specified as 'Same as product', 'Same as input', or 'Custom'.

CustomAccumulatorDataType — Accumulator word and fraction lengths

numericType(true,32,30) (default) | scaled numericType object

Accumulator word and fraction lengths, specified as a scaled numericType object. This property applies only when you set the AccumulatorDataType property to 'Custom'.

Usage

Syntax

```
V = blkMatcher(I)
C = blkMatcher(I)
Y = blkMatcher(I,iref)
```

Description

`V = blkMatcher(I)` computes the motion of input image `I` from one video frame to another, and returns `V` as a matrix of velocity magnitudes.

`C = blkMatcher(I)` computes the motion of input image `I` from one video frame to another, and returns `C` as a complex matrix of horizontal and vertical components, when you set the `OutputValue` property to `Horizontal` and vertical components in complex form.

`Y = blkMatcher(I,iref)` computes the motion between input image `I` and reference image `iref` when you set the `ReferenceFrameSource` property to `Input` port.

Input Arguments

I – Input data

scalar | vector | matrix

Input data, specified as a scalar, vector, or matrix of intensity values.

iref – Input reference data

scalar | vector | matrix

Input reference data, specified as a scalar, vector, or matrix of intensity values.

Output Arguments

V – Velocity magnitudes

matrix

Velocity magnitudes, returned as a matrix.

C – Horizontal and vertical components

matrix

Horizontal and vertical components, returned as a complex matrix.

Y – Motion between inputs

matrix

Motion between image and reference image, returned as a matrix.

Object Functions

To use an object function, specify the System object as the first input argument. For example, to release system resources of a System object named `obj`, use this syntax:

```
release(obj)
```

Common to All System Objects

<code>step</code>	Run System object algorithm
<code>release</code>	Release resources and allow changes to System object property values and input characteristics
<code>reset</code>	Reset internal states of System object

Examples

Estimate Motion Using BlockMatcher

Read and convert RGB image to grayscale.

```
img1 = im2double(im2gray(imread('onion.png')));
```

Create a block matcher and alpha blender object.

```
hbm = vision.BlockMatcher('ReferenceFrameSource', ...  
    'Input port', 'BlockSize', [35 35]);
```

```
hbm.OutputValue = 'Horizontal and vertical components in complex form';  
halphablend = vision.AlphaBlender;
```

Offset the first image by [5 5] pixels to create a second image.

```
img2 = imtranslate(img1,[5,5]);
```

Compute motion for the two images.

```
motion = hbm(img1,img2);
```

Blend the two images.

```
img12 = halphablend(img2,img1);
```

Use a quiver plot to show the direction of motion on the images.

```
[X,Y] = meshgrid(1:35:size(img1,2),1:35:size(img1,1));  
imshow(img12)  
hold on  
quiver(X(:),Y(:),real(motion(:)),imag(motion(:)),0)  
hold off
```

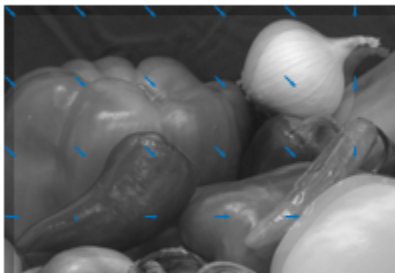

See Also

[opticalFlow](#) | [opticalFlowFarneback](#) | [opticalFlowHS](#) | [opticalFlowLK](#) | [opticalFlowLKDoG](#)

Introduced in R2012a

vision.CascadeObjectDetector

Package: vision

Detect objects using the Viola-Jones algorithm

Description

The cascade object detector uses the Viola-Jones algorithm to detect people's faces, noses, eyes, mouth, or upper body. You can also use the **Image Labeler** to train a custom classifier to use with this System object. For details on how the function works, see "Get Started with Cascade Object Detector".

To detect facial features or upper body in an image:

- 1 Create the `vision.CascadeObjectDetector` object and set its properties.
- 2 Call the object with arguments, as if it were a function.

To learn more about how System objects work, see [What Are System Objects?](#)

Creation

Syntax

```
detector = vision.CascadeObjectDetector
detector = vision.CascadeObjectDetector(model)
detector = vision.CascadeObjectDetector(XMLFILE)
detector = vision.CascadeObjectDetector(Name,Value)
```

Description

`detector = vision.CascadeObjectDetector` creates a detector to detect objects using the Viola-Jones algorithm.

`detector = vision.CascadeObjectDetector(model)` creates a detector configured to detect objects defined by the input character vector, `model`.

`detector = vision.CascadeObjectDetector(XMLFILE)` creates a detector and configures it to use the custom classification model specified with the `XMLFILE` input.

`detector = vision.CascadeObjectDetector(Name,Value)` sets properties using one or more name-value pairs. Enclose each property name in quotes. For example, `detector = vision.CascadeObjectDetector('ClassificationModel','UpperBody')`

Properties

Unless otherwise indicated, properties are *nontunable*, which means you cannot change their values after calling the object. Objects lock when you call them, and the `release` function unlocks them.

If a property is *tunable*, you can change its value at any time.

For more information on changing property values, see System Design in MATLAB Using System Objects.

ClassificationModel — Trained cascade classification model

'FrontalFaceCART' (default) | character string

Trained cascade classification model, specified as a character vector. The `ClassificationModel` property controls the type of object to detect. By default, the detector is configured to detect faces.

You can set this character vector to an XML file containing a custom classification model, or to one of the valid model character vectors listed below. You can train a custom classification model using the `trainCascadeObjectDetector` function. The function can train the model using Haar-like features, histograms of oriented gradients (HOG), or local binary patterns (LBP). For details on how to use the function, see “Get Started with Cascade Object Detector”.

Classification Model	Image Size Used to Train Model	Model Description
'FrontalFaceCART' (Default)	[20 20]	Detects faces that are upright and forward facing. This model is composed of weak classifiers, based on the classification and regression tree analysis (CART). These classifiers use Haar features to encode facial features. CART-based classifiers provide the ability to model higher-order dependencies between facial features. [1]
'FrontalFaceLBP'	[24 24]	Detects faces that are upright and forward facing. This model is composed of weak classifiers, based on a decision stump. These classifiers use local binary patterns (LBP) to encode facial features. LBP features can provide robustness against variation in illumination. [2]
'UpperBody'	[18 22]	Detects the upper-body region, which is defined as the head and shoulders area. This model uses Haar features to encode the details of the head and shoulder region. Because it uses more features around the head, this model is more robust against pose changes, e.g. head rotations/tilts. [3]
'EyePairBig' 'EyePairSmall'	[11 45] [5 22]	Detects a pair of eyes. The 'EyePairSmall' model is trained using a smaller image. This enables the model to detect smaller eyes than the 'EyePairBig' model can detect.[4]
'LeftEye' 'RightEye'	[12 18]	Detects the left and right eye separately. These models are composed of weak classifiers, based on a decision stump. These classifiers use Haar features to encode details.[4]
'LeftEyeCART' 'RightEyeCART'	[20 20]	Detects the left and right eye separately. The weak classifiers that make up these models are CART-trees. Compared to decision stumps, CART-tree-based classifiers are better able to model higher-order dependencies. [5]

Classification Model	Image Size Used to Train Model	Model Description
'ProfileFace'	[20 20]	Detects upright face profiles. This model is composed of weak classifiers, based on a decision stump. These classifiers use Haar features to encode face details.
'Mouth'	[15 25]	Detects the mouth. This model is composed of weak classifiers, based on a decision stump, which use Haar features to encode mouth details.[4]
'Nose'	[15 18]	This model is composed of weak classifiers, based on a decision stump, which use Haar features to encode nose details.[4]

MinSize — Size of smallest detectable object

[] (default) | two-element vector

Size of smallest detectable object, specified as a two-element vector [*height width*]. Set this property in pixels for the minimum size region containing an object. The value must be greater than or equal to the image size used to train the model. Use this property to reduce computation time when you know the minimum object size prior to processing the image. When you do not specify a value for this property, the detector sets it to the size of the image used to train the classification model.

For details explaining the relationship between setting the size of the detectable object and the `ScaleFactor` property, see “Algorithms” on page 2-512 section.

Tunable: Yes

MaxSize — Size of largest detectable object

[] (default) | two-element vector

Size of largest detectable object, specified as a two-element vector [*height width*]. Specify the size in pixels of the largest object to detect. Use this property to reduce computation time when you know the maximum object size prior to processing the image. When you do not specify a value for this property, the detector sets it to `size(I)`.

For details explaining the relationship between setting the size of the detectable object and the `ScaleFactor` property, see the “Algorithms” on page 2-512 section.

ScaleFactor — Scaling for multiscale object detection

1.1 (default) | scalar

Scaling for multiscale object detection, specified as a value greater than 1.0001. The scale factor incrementally scales the detection resolution between `MinSize` and `MaxSize`. You can set the scale factor to an ideal value using:
`size(I)/(size(I)-0.5)`

The detector scales the search region at increments between `MinSize` and `MaxSize` using the following relationship:

$$\text{search region} = \text{round}((\text{Training Size}) * (\text{ScaleFactor}^N))$$

N is the current increment, an integer greater than zero, and *Training Size* is the image size used to train the classification model.

Tunable: Yes

MergeThreshold — Detection threshold

4 (default) | integer

Detection threshold, specified as an integer. The threshold defines the criteria needed to declare a final detection in an area where there are multiple detections around an object. Groups of colocated detections that meet the threshold are merged to produce one bounding box around the target object. Increasing this threshold may help suppress false detections by requiring that the target object be detected multiple times during the multiscale detection phase. When you set this property to 0, all detections are returned without performing thresholding or merging operation. This property is tunable.

UseROI — Use region of interest

false (default) | true

Use region of interest, specified as false or true. Set this property to true to detect objects within a rectangular region of interest within the input image.

Usage

Syntax

```
bbox = detector(I)
bbox = detector(I, roi)
```

Description

`bbox = detector(I)` returns an M -by-4 matrix, `bbox`, that defines M bounding boxes containing the detected objects. The detector performs multiscale object detection on the input image, `I`.

`bbox = detector(I, roi)` detects objects within the rectangular search region specified by `roi`. Set the 'UseROI' property to true to use this syntax.

Input Arguments

I — Input image

grayscale | truecolor (RGB)

Input image, specified as grayscale or truecolor (RGB).

model — Classification model

'FrontalFaceCART' (default) | character string

Classification model, specified as a character vector. The `model` input describes the type of object to detect. There are several valid `model` character vectors, such as 'FrontalFaceCART', 'UpperBody', and 'ProfileFace'. See the `ClassificationModel` property description for a full list of available models.

XMLFILE — Custom classification model

XML file

Custom classification model, specified as an XML file. The XMLFILE can be created using the `trainCascadeObjectDetector` function or OpenCV (Open Source Computer Vision) training functionality. You must specify a full or relative path to the XMLFILE, if it is not on the MATLAB path.

roi — Rectangular region of interest

four-element vector (default)

Rectangular region of interest within image *I*, specified as a four-element vector, [*x y width height*].

Output Arguments**bbox — Detections**

M-by-4 matrix (default)

Detections, returned as an *M*-by-4 element matrix. Each row of the output matrix contains a four-element vector, [*x y width height*], that specifies in pixels, the upper-left corner and size of a bounding box.

Object Functions

To use an object function, specify the System object as the first input argument. For example, to release system resources of a System object named *obj*, use this syntax:

```
release(obj)
```

Common to All System Objects

<code>step</code>	Run System object algorithm
<code>release</code>	Release resources and allow changes to System object property values and input characteristics
<code>reset</code>	Reset internal states of System object

Examples**Detect Faces in an Image Using the Frontal Face Classification Model**

Create a face detector object.

```
faceDetector = vision.CascadeObjectDetector;
```

Read the input image.

```
I = imread('visionteam.jpg');
```

Detect faces.

```
bboxes = faceDetector(I);
```

Annotate detected faces.

```
IFaces = insertObjectAnnotation(I, 'rectangle', bboxes, 'Face');  
figure  
imshow(IFaces)  
title('Detected faces');
```

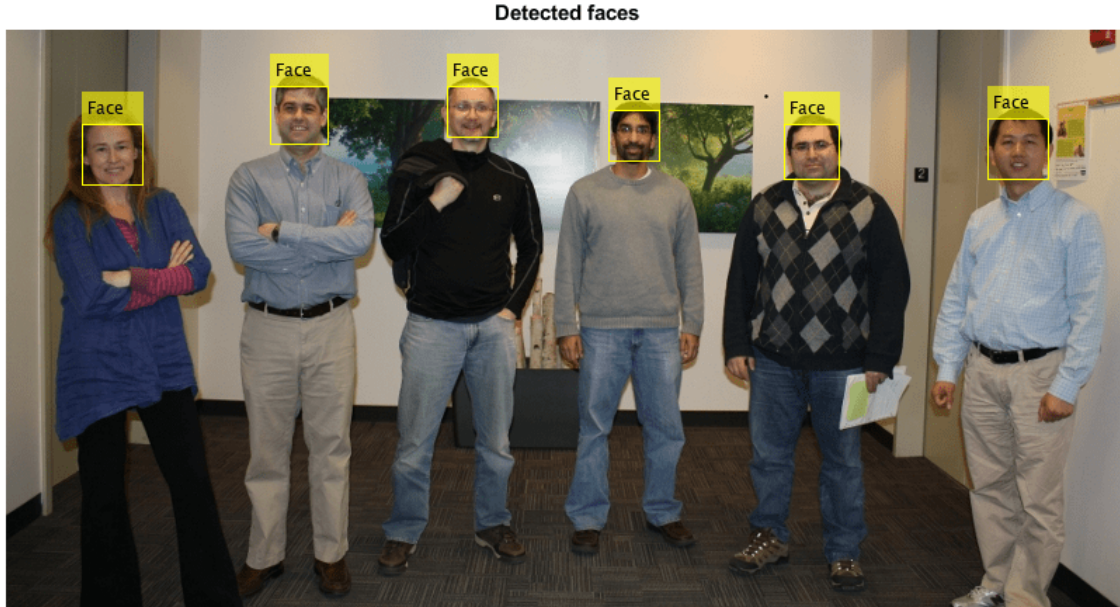

Detect Upper Body in Image Using Upper Body Classification Model

Create a body detector object and set properties.

```
bodyDetector = vision.CascadeObjectDetector('UpperBody');
bodyDetector.MinSize = [60 60];
bodyDetector.MergeThreshold = 10;
```

Read input image and detect upper body.

```
I2 = imread('visionteam.jpg');
bboxBody = bodyDetector(I2);
```

Annotate detected upper bodies.

```
IBody = insertObjectAnnotation(I2, 'rectangle', bboxBody, 'Upper Body');
figure
imshow(IBody)
title('Detected upper bodies');
```

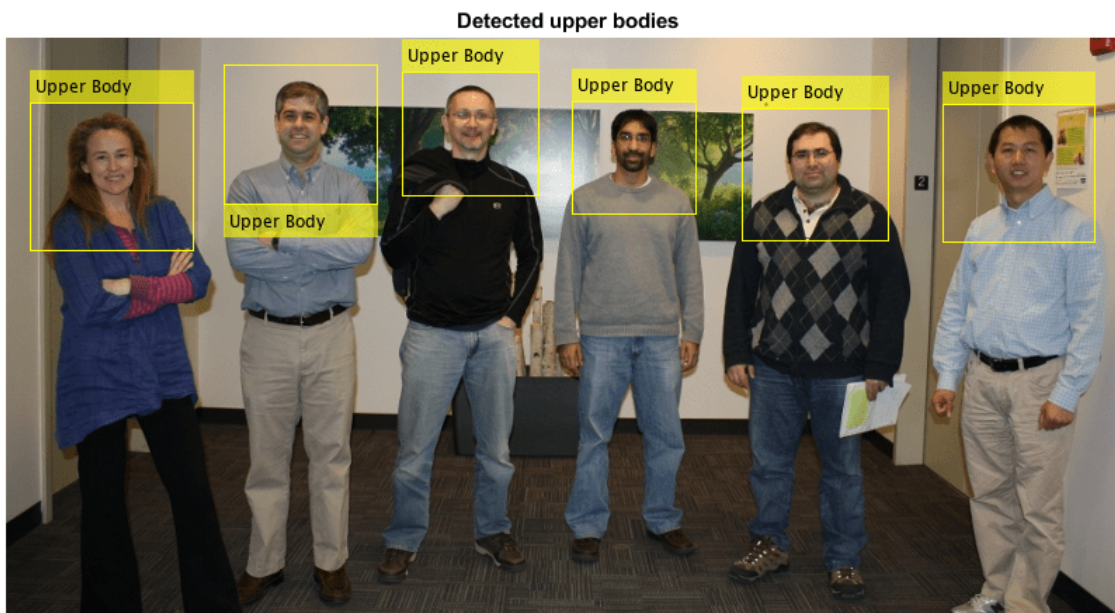

Algorithms

Classification Model Training

Each model is trained to detect a specific type of object. The classification models are trained by extracting features from a set of known images. These extracted features are then fed into a learning algorithm to train the classification model. Computer Vision Toolbox software uses the Viola-Jones cascade object detector. This detector uses HOG[7], LBP[8], and Haar-like [6] features and a cascade of classifiers trained using boosting.

The image size used to train the classifiers defines the smallest region containing the object. Training image sizes vary according to the application, type of target object, and available positive images. You must set the `MinSize` property to a value greater than or equal to the image size used to train the model.

Cascade of Classifiers

This object uses a cascade of classifiers to efficiently process image regions for the presence of a target object. Each stage in the cascade applies increasingly more complex binary classifiers, which allows the algorithm to rapidly reject regions that do not contain the target. If the desired object is not found at any stage in the cascade, the detector immediately rejects the region and processing is terminated. By terminating, the object avoids invoking computation-intensive classifiers further down the cascade.

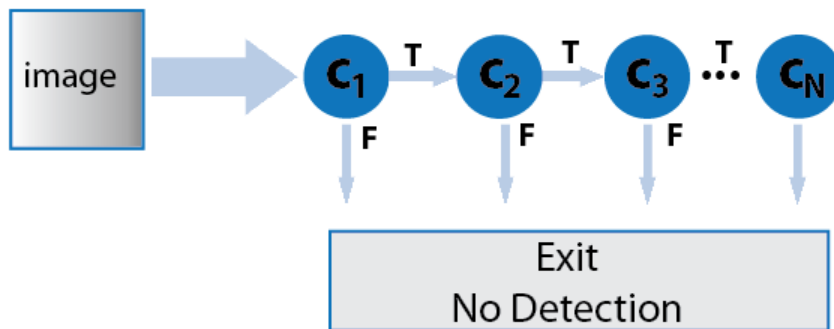

Multiscale Object Detection

The detector incrementally scales the input image to locate target objects. At each scale increment, a sliding window, whose size is the same as the training image size, scans the scaled image to locate objects. The `ScaleFactor` property determines the amount of scaling between successive increments.

The search region size is related to the `ScaleFactor` in the following way:

$$\text{search region} = \text{round}((\text{ObjectTrainingSize}) * (\text{ScaleFactor}^N))$$

N is the current increment, an integer greater than zero, and `ObjectTrainingSize` is the image size used to train the classification model.

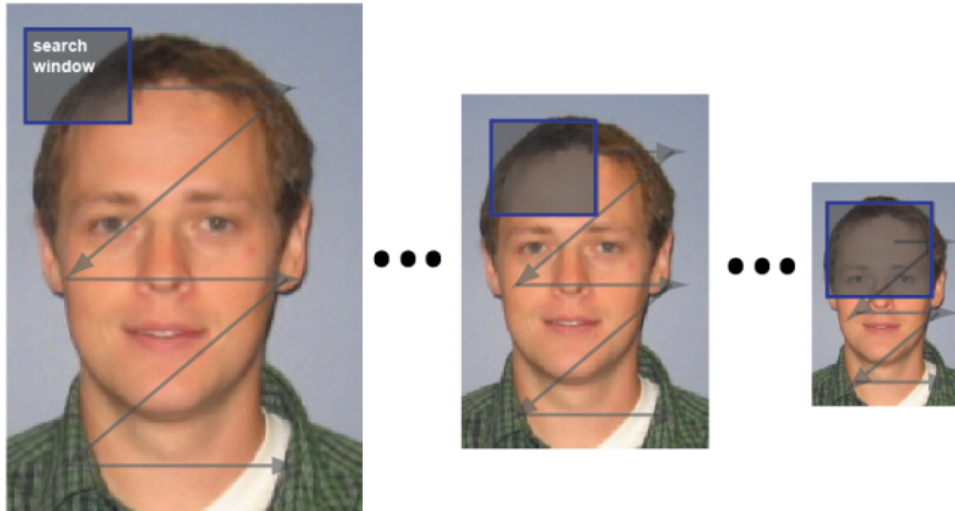

The search window traverses the image for each scaled increment.

Relationship Between `MinSize`, `MaxSize`, and `ScaleFactor`

Understanding the relationship between the size of the object to detect and the scale factor will help you set the properties accordingly. The `MinSize` and `MaxSize` properties limit the size range of the object to detect. Ideally, these properties are modified to reduce computation time when you know the approximate object size prior to processing the image. They are not designed to provide precise filtering of results, based on object size. The behavior of these properties is affected by the `ScaleFactor`. The scale factor determines the quantization of the search window sizes.

search region = round((*Training Size*)*(ScaleFactor^N))

The actual range of returned object sizes may not be exactly what you select for the `MinSize` and `MaxSize` properties. For example,

For a `ScaleFactor` value of 1.1 with a 24x24 training size, for 5 increments, the search region calculation would be:



```
>> search region = round(24*1.1^(1:5))
```

```
>> 26 29 32 35 39
```

If you were to set `MaxSize` to 34, due to the search region quantization, the actual maximum object size used by the algorithm would be 32.

Merge Detection Threshold

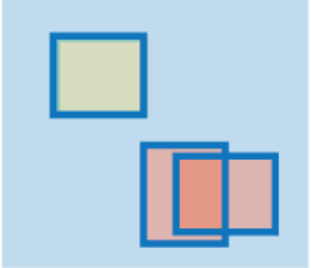
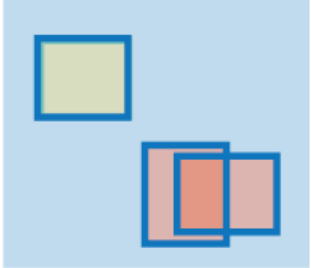
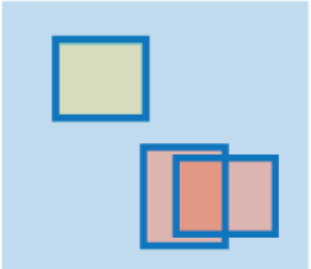
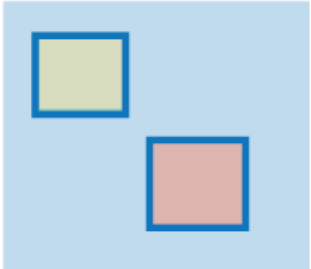
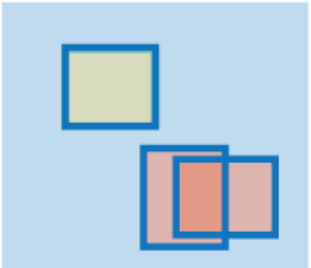
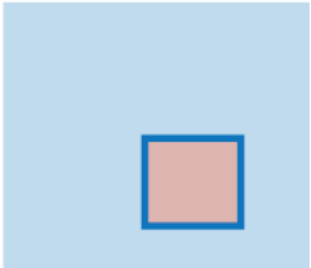
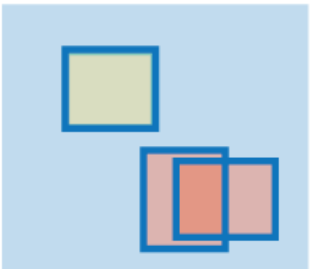
For each increment in scale, the search window traverses over the image producing multiple detections around the target object. The multiple detections are merged into one bounding box per target object. You can use the `MergeThreshold` property to control the number of detections required before combining or rejecting the detections. The size of the final bounding box is an average of the sizes of the bounding boxes for the individual detections and lies between `MinSize` and `MaxSize`.

MergeThreshold	Detections	Returned Bounding Boxes
0		
1		
2		
3		

References

- [1] Lienhart R., Kuranov A., and V. Pisarevsky "Empirical Analysis of Detection Cascades of Boosted Classifiers for Rapid Object Detection." *Proceedings of the 25th DAGM Symposium on Pattern Recognition*. Magdeburg, Germany, 2003.
- [2] Ojala Timo, Pietikäinen Matti, and Mäenpää Topi, "Multiresolution Gray-Scale and Rotation Invariant Texture Classification with Local Binary Patterns" . In *IEEE Transactions on Pattern Analysis and Machine Intelligence*, 2002. Volume 24, Issue 7, pp. 971-987.

- [3] Kruppa H., Castrillon-Santana M., and B. Schiele. "Fast and Robust Face Finding via Local Context" . *Proceedings of the Joint IEEE International Workshop on Visual Surveillance and Performance Evaluation of Tracking and Surveillance*, 2003, pp. 157-164.
- [4] Castrillón Marco, Déniz Oscar, Guerra Cayetano, and Hernández Mario, " ENCARA2: Real-time detection of multiple faces at different resolutions in video streams" . In *Journal of Visual Communication and Image Representation*, 2007 (18) 2: pp. 130-140.
- [5] Yu Shiqi " Eye Detection." Shiqi Yu's Homepage. <http://yushiqi.cn/research/eyedetection>.
- [6] Viola, Paul and Michael J. Jones, " Rapid Object Detection using a Boosted Cascade of Simple Features" , *Proceedings of the 2001 IEEE Computer Society Conference on Computer Vision and Pattern Recognition*, 2001. Volume: 1, pp.511-518.
- [7] Dalal, N., and B. Triggs, " Histograms of Oriented Gradients for Human Detection" . *IEEE Computer Society Conference on Computer Vision and Pattern Recognition*. Volume 1, (2005), pp. 886-893.
- [8] Ojala, T., M. Pietikainen, and T. Maenpaa, " Multiresolution Gray-scale and Rotation Invariant Texture Classification With Local Binary Patterns" . *IEEE Transactions on Pattern Analysis and Machine Intelligence*. Volume 24, No. 7 July 2002, pp. 971-987.

Extended Capabilities

C/C++ Code Generation

Generate C and C++ code using MATLAB® Coder™.

Usage notes and limitations:

- Generates portable C code using a C++ compiler that links to OpenCV (Version 3.4.0) libraries. See "Portable C Code Generation for Functions That Use OpenCV Library".
- See "System Objects in MATLAB Code Generation" (MATLAB Coder).
- XMLFILE must be a compile-time constant.

See Also

Image Labeler | `trainCascadeObjectDetector` | `insertShape` | `vision.PeopleDetector` | `integralImage`

Topics

"Face Detection and Tracking Using CAMShift"
"Face Detection and Tracking Using the KLT Algorithm"
"Face Detection and Tracking Using Live Video Acquisition"
"Detect and Track Face"
"Get Started with the Image Labeler"
"Get Started with Cascade Object Detector"
"Multiple Object Tracking"

External Websites

Detect and Track Multiple Faces in a Live Video Stream

Introduced in R2012a

vision.Deinterlacer

Package: vision

Remove motion artifacts by deinterlacing input video signal

Description

To remove motion artifacts by deinterlacing input video signal.

To track a set of points:

- 1 Create the `vision.Deinterlacer` object and set its properties.
- 2 Call the object with arguments, as if it were a function.

To learn more about how System objects work, see [What Are System Objects?](#)

Creation

Syntax

```
Hdeinterlacer = vision.Deinterlacer
Hdeinterlacer = vision.Deinterlacer(Name,Value)
```

Description

`Hdeinterlacer = vision.Deinterlacer` returns a deinterlacing System object, `Hdeinterlacer`, that removes motion artifacts from images composed of weaved top and bottom fields of an interlaced signal.

`Hdeinterlacer = vision.Deinterlacer(Name,Value)` sets properties using one or more name-value pairs. Enclose each property name in quotes. For example, `varObj = vision.Deinterlacer('Method','Line repetition')`

Properties

Unless otherwise indicated, properties are *nontunable*, which means you cannot change their values after calling the object. Objects lock when you call them, and the `release` function unlocks them.

If a property is *tunable*, you can change its value at any time.

For more information on changing property values, see [System Design in MATLAB Using System Objects](#).

Method — Method used to deinterlace input video

```
'Line repetition' (default) | 'Linear interpolation' | 'Vertical temporal median filtering'
```

Method used to deinterlace input video, specified as `'Line repetition'`, `'Linear interpolation'`, `'Vertical temporal median filtering'`.

TransposedInput — Indicate if input data is in row-major order`false (default) | true`

Indicate if input data is in row-major order, specified as `true` or `false`. Set this property to `true` if the input buffer contains data elements from the first row first, then the second row second, and so on.

Fixed-Point Properties**RoundingMethod — Rounding method for fixed-point operations**`'Floor' (default) | 'Ceiling' | 'Convergent' | 'Nearest' | 'Round' | 'Simplest' | 'Zero'`

Rounding method for fixed-point operations, specified as `'Floor'`, `'Ceiling'`, `'Convergent'`, `'Nearest'`, `'Round'`, `'Simplest'`, or `'Zero'`.

OverflowAction — Action to take when integer input is out-of-range`'Wrap' (default) | 'Saturate'`

Action to take when integer input is out-of-range, specified as `'Wrap'` or `'Saturate'`.

ProductDataType — Product data type`'Same as input' (default) | 'Custom'`

Product data type, specified as `'Same as input'` or `'Custom'`.

CustomProductDataType — Product word and fraction lengths`numerictype(true,32,30) (default) | scaled numerictype object`

Product word and fraction lengths, specified as a scaled `numerictype` object. This property applies only when you set the `AccumulatorDataType` property to `'Custom'`.

AccumulatorDataType — Data type of accumulator`'Same as product' (default) | 'Same as input' | 'Custom'`

Data type of accumulator, specified as `'Same as product'`, `'Same as input'`, or `'Custom'`.

CustomAccumulatorDataType — Accumulator word and fraction lengths`numerictype(true,32,30) (default) | scaled numerictype object`

Accumulator word and fraction lengths, specified as a scaled `numerictype` object. This property applies only when you set the `AccumulatorDataType` property to `'Custom'`.

Usage**Syntax**

```
value = Hdeinterlacer(input)
```

Description

`value = Hdeinterlacer(input)` deinterlaces the input according to the algorithm set in the `Method` property

Input Arguments

input — Input data

top and bottom fields of interlaced video

Input data, specified as a combination of top and bottom fields of interlaced video.

Output Arguments

value — Frames of deinterlaced video

top and bottom fields of interlaced video

Frames of deinterlaced video, returned as the same data type as the input

Object Functions

To use an object function, specify the System object as the first input argument. For example, to release system resources of a System object named `obj`, use this syntax:

```
release(obj)
```

Common to All System Objects

<code>step</code>	Run System object algorithm
<code>release</code>	Release resources and allow changes to System object property values and input characteristics
<code>reset</code>	Reset internal states of System object

Examples

Remove Motion Artifacts From Image

Create a deinterlacer object.

```
hdinterlacer = vision.Deinterlacer;
```

Read an image with motion artifacts.

```
I = imread('vipinterlace.png');
```

Apply the deinterlacer to the image.

```
clearimage = hdinterlacer(I);
```

Display the results.

```
imshow(I);
title('Original Image');
```

Original Image



```
figure, imshow(clearimage);  
title('Image after deinterlacing');
```

Image after deinterlacing



Extended Capabilities

C/C++ Code Generation

Generate C and C++ code using MATLAB® Coder™.

Usage notes and limitations:

- See “System Objects in MATLAB Code Generation” (MATLAB Coder).

See Also

Deinterlacing

Introduced in R2012a

vision.ForegroundDetector

Package: vision

Foreground detection using Gaussian mixture models

Description

The `ForegroundDetector` compares a color or grayscale video frame to a background model to determine whether individual pixels are part of the background or the foreground. It then computes a foreground mask. By using background subtraction, you can detect foreground objects in an image taken from a stationary camera.

To detect foreground in an image :

- 1 Create the `vision.ForegroundDetector` object and set its properties.
- 2 Call the object with arguments, as if it were a function.

To learn more about how System objects work, see [What Are System Objects?](#)

Creation

Syntax

```
detector = vision.ForegroundDetector  
detector = vision.ForegroundDetector(Name,Value)
```

Description

`detector = vision.ForegroundDetector` computes and returns a foreground mask using the Gaussian mixture model (GMM).

`detector = vision.ForegroundDetector(Name,Value)` sets properties using one or more name-value pairs. Enclose each property name in quotes. For example, `detector = vision.ForegroundDetector('LearningRate',0.005)`

Properties

Unless otherwise indicated, properties are *nontunable*, which means you cannot change their values after calling the object. Objects lock when you call them, and the `release` function unlocks them.

If a property is *tunable*, you can change its value at any time.

For more information on changing property values, see [System Design in MATLAB Using System Objects](#).

AdaptLearningRate — Adapt learning rate

'true' (default) | 'false'

Adapt learning rate, specified as 'true' or 'false'. This property enables the object to adapt the learning rate during the period specified by the NumTrainingFrames property. When you set this property to true, the object sets the LearningRate property to 1/(current frame number). When you set this property to false, the LearningRate property must be set at each time step.

NumTrainingFrames — Number of initial video frames for training background model

150 (default) | integer

Number of initial video frames for training background model, specified as an integer. When you set the AdaptLearningRate to false, this property will not be available.

LearningRate — Learning rate for parameter updates

0.005 (default) | numeric scalar

Learning rate for parameter updates, specified as a numeric scalar. Specify the learning rate to adapt model parameters. This property controls how quickly the model adapts to changing conditions. Set this property appropriately to ensure algorithm stability.

The learning rate specified by this property can only be implemented when you set the AdaptLearningRate to true and after the training period specified by NumTrainingFrames is over.

Tunable: Yes

MinimumBackgroundRatio — Threshold to determine background model

0.7 (default) | numeric scalar

Threshold to determine background model, specified as a numeric scalar. Set this property to represent the minimum possibility for pixels to be considered background values. Multimodal backgrounds cannot be handled if this value is too small.

NumGaussians — Number of Gaussian modes in the mixture model

5 (default) | positive integer

Number of Gaussian modes in the mixture model, specified as a positive integer. Typically, you would set this value to 3, 4 or 5. Set the value to 3 or greater to be able to model multiple background modes.

InitialVariance — Initial mixture model variance

'Auto' (default) | numeric scalar

Initial mixture model variance, specified as a numeric scalar or the 'Auto' character vector.

Image Data Type	Initial Variance
double/single	$(30/255)^2$
uint8	30^2

This property applies to all color channels for color inputs.

Usage

Syntax

```
foregroundMask = detector(I)  
foregroundMask = detector(I, learningRate)
```

Description

`foregroundMask = detector(I)` computes the foreground mask for input image `I`, and returns a logical mask. Values of 1 in the mask correspond to foreground pixels.

`foregroundMask = detector(I, learningRate)` computes the foreground mask using the `LearningRate`.

Input Arguments

I — Input image

grayscale | truecolor (RGB)

Input image, specified as grayscale or truecolor (RGB).

LearningRate — Learning rate for parameter updates

0.005 (default) | numeric scalar

Learning rate for parameter updates, specified as a numeric scalar. Specify the learning rate to adapt model parameters. This property controls how quickly the model adapts to changing conditions. Set this property appropriately to ensure algorithm stability.

The learning rate specified by this property can only be implemented when you set the `AdaptLearningRate` to `true` and after the training period specified by `NumTrainingFrames` is over.

Tunable: Yes

Output Arguments

foregroundMask — Foreground mask

binary mask

Foreground mask computed using a Gaussian mixture model, returned as a binary mask.

Object Functions

To use an object function, specify the `System` object as the first input argument. For example, to release system resources of a `System` object named `obj`, use this syntax:

```
release(obj)
```

Common to All System Objects

`step` Run System object algorithm

release Release resources and allow changes to System object property values and input characteristics
 reset Reset internal states of System object

Examples

Detect Moving Cars In Video

Create a video source object to read file.

```
videoSource = VideoReader('viptraffic.avi');
```

Create a detector object and set the number of training frames to 5 (because it is a short video.) Set initial standard deviation.

```
detector = vision.ForegroundDetector(...
    'NumTrainingFrames', 5, ...
    'InitialVariance', 30*30);
```

Perform blob analysis.

```
blob = vision.BlobAnalysis(...
    'CentroidOutputPort', false, 'AreaOutputPort', false, ...
    'BoundingBoxOutputPort', true, ...
    'MinimumBlobAreaSource', 'Property', 'MinimumBlobArea', 250);
```

Insert a border.

```
shapeInserter = vision.ShapeInserter('BorderColor','White');
```

Play results. Draw bounding boxes around cars.

```
videoPlayer = vision.VideoPlayer();
while hasFrame(videoSource)
    frame = readFrame(videoSource);
    fgMask = detector(frame);
    bbox = blob(fgMask);
    out = shapeInserter(frame,bbox);
    videoPlayer(out);
    pause(0.1);
end
```

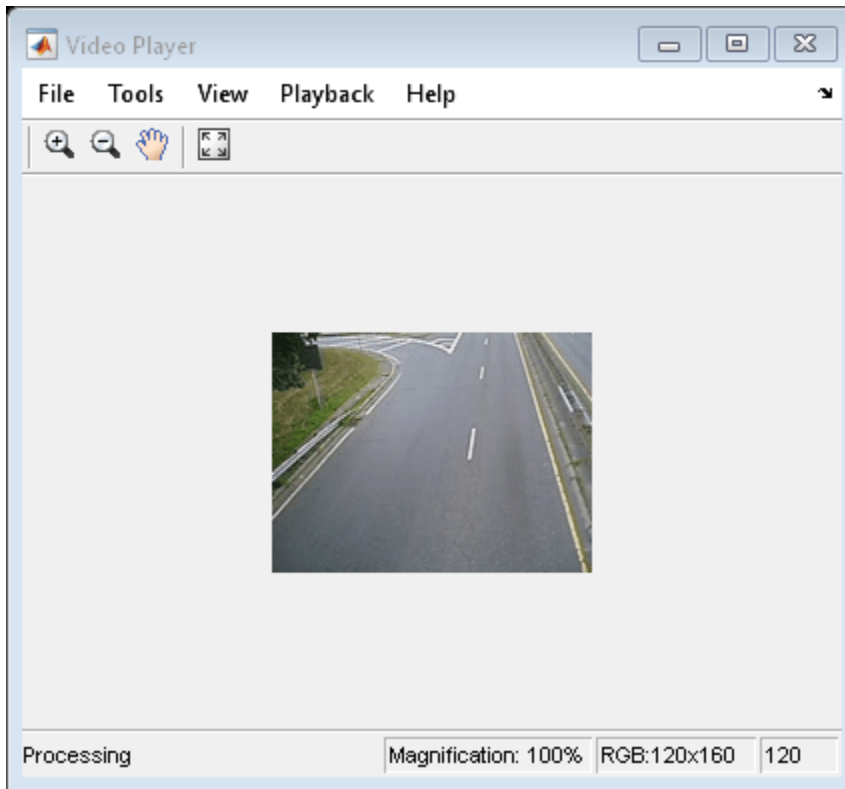

Release objects.

```
release(videoPlayer);
```

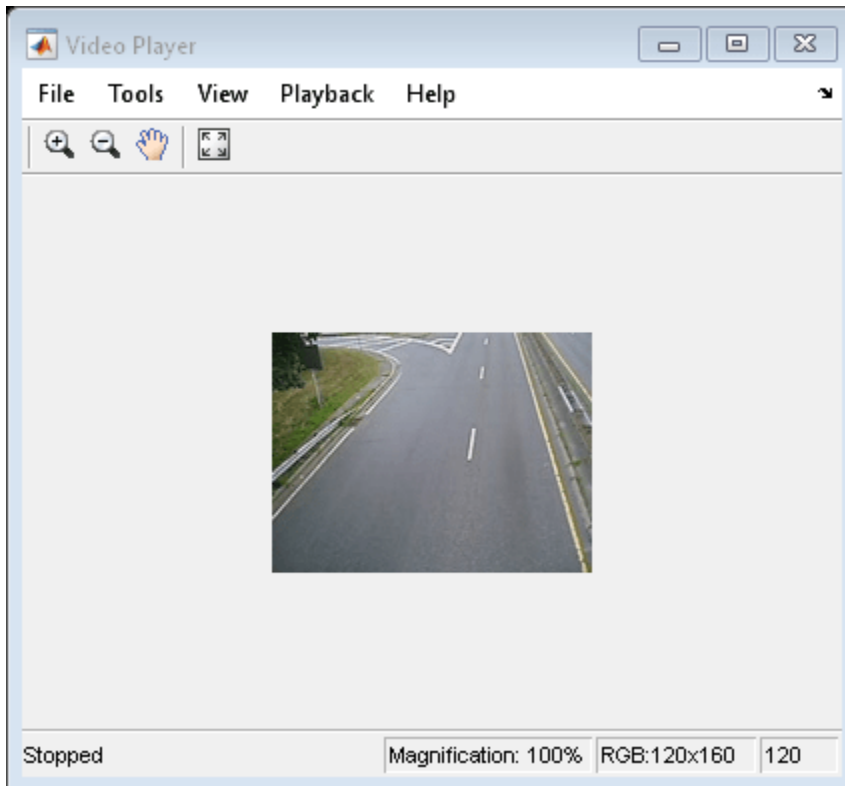

References

- [1] Kaewtrakulpong, P. and R. Bowden. *An Improved Adaptive Background Mixture Model for Realtime Tracking with Shadow Detection*. In Proc. 2nd European Workshop on Advanced Video Based Surveillance Systems, AVBS01, VIDEO BASED SURVEILLANCE SYSTEMS: Computer Vision and Distributed Processing (September 2001)
- [2] Stauffer, C. and W.E.L. Grimson. *Adaptive Background Mixture Models for Real-Time Tracking*, Computer Vision and Pattern Recognition, IEEE Computer Society Conference on, Vol. 2 (06 August 1999), pp. 2246-252 Vol. 2.

Extended Capabilities

C/C++ Code Generation

Generate C and C++ code using MATLAB® Coder™.

Usage notes and limitations:

- Generates platform-dependent library for MATLAB host target.
- Generates portable C code for non MATLAB host target.
- See "System Objects in MATLAB Code Generation" (MATLAB Coder).

See Also

Topics

“Multiple Object Tracking”

Introduced in R2011a

vision.GammaCorrector

Package: vision

Apply or remove gamma correction from images or video streams

Description

To apply gamma correction to input images or a video stream:

- 1 Create the `vision.GammaCorrector` object and set its properties.
- 2 Call the object with arguments, as if it were a function.

To learn more about how System objects work, see [What Are System Objects?](#)

Creation

Syntax

```
gammaCorr = vision.GammaCorrector
gammaCorr = vision.GammaCorrector(Name,Value)
gammaCorr = vision.GammaCorrector(gamma,Name,Value)
```

Description

`gammaCorr = vision.GammaCorrector` returns a gamma corrector object, `gammaCorr`. You can use the gamma corrector to apply or remove gamma correction from images or video streams.

`gammaCorr = vision.GammaCorrector(Name,Value)` sets properties using one or more name-value pairs. Enclose each property name in quotes. For example, `gammaCorr = vision.GammaCorrector('Correction','Gamma')`

`gammaCorr = vision.GammaCorrector(gamma,Name,Value)` additionally sets the `Gamma` property.

Properties

Unless otherwise indicated, properties are *nontunable*, which means you cannot change their values after calling the object. Objects lock when you call them, and the `release` function unlocks them.

If a property is *tunable*, you can change its value at any time.

For more information on changing property values, see [System Design in MATLAB Using System Objects](#).

Correction — Specify gamma correction or linearization

'Gamma' (default) | 'De-gamma'

Specify gamma correction or linearization, specified as 'Gamma' or 'De-gamma'.

Gamma — Gamma value of output or input

2.2 (default) | numeric scalar

Gamma value of output or input, specified as numeric scalar greater than or equal to 1. When you set the `Correction` property to `Gamma`, this property gives the desired gamma value of the output video stream. When you set the `Correction` property to `De-gamma`, this property indicates the gamma value of the input video stream.

LinearSegment — Enable gamma curve to have linear portion near origin

true (default) | false

Enable gamma curve to have linear portion near origin, specified as `true` or `false`.

BreakPoint — I-axis value of the end of gamma correction linear segment

0.018 (default) | numeric scalar

I-axis value of the end of gamma correction linear segment, specified as a numeric scalar value in the range (0,1). This property applies when you set the `LinearSegment` property to `true`.

Usage

Syntax

```
y = gammaCorr(input)
```

Description

`y = gammaCorr(input)` applies or removes gamma correction from input `I`, and returns the gamma corrected or linearized output `y`.

Input Arguments

input — Input*M*-by-*N* matrix of intensity values | *M*-by-*N*-*P* color video

Input, specified as an *M*-by-*N* matrix of intensity values or *M*-by-*N*-*P* color video, where *P* is the number of color planes.

Output Arguments

y — Corrected input

same as input (default)

Output, returned as an *M*-by-*N* matrix of intensity values or *M*-by-*N*-*P* color video, where *P* is the number of color planes.

Object Functions

To use an object function, specify the System object as the first input argument. For example, to release system resources of a System object named `obj`, use this syntax:

```
release(obj)
```

Common to All System Objects

step Run System object algorithm
release Release resources and allow changes to System object property values and input characteristics
reset Reset internal states of System object

Examples

Improve Image Contrast Using Gamma Correction

Create a gamma corrector object with the gamma property set to 2.0.

```
hgamma = vision.GammaCorrector(2.0, 'Correction', 'De-gamma');
```

Read an image.

```
img = imread('pears.png');
```

Apply gamma correction.

```
imgCor = hgamma(img);
```

Show the original and corrected images.

```
imshow(img); title('Original Image');
```

Original Image



```
figure,  
imshow(imgCor);  
title('Enhanced Image after De-gamma Correction');
```

Enhanced Image after De-gamma Correction



Extended Capabilities

C/C++ Code Generation

Generate C and C++ code using MATLAB® Coder™.

Usage notes and limitations:

- See “System Objects in MATLAB Code Generation” (MATLAB Coder).

See Also

gamma

Introduced in R2012a

vision.HistogramBasedTracker

Package: vision

Histogram-based object tracking

Description

The histogram-based tracker incorporates the continuously adaptive mean shift (CAMShift) algorithm for object tracking. It uses the histogram of pixel values to identify the tracked object.

To track an object:

- 1 Create the `vision.HistogramBasedTracker` object and set its properties.
- 2 Call the object with arguments, as if it were a function.

To learn more about how System objects work, see [What Are System Objects?](#)

Creation

Syntax

```
hbtracker = vision.HistogramBasedTracker
hbtracker = vision.HistogramBasedTracker(Name,Value)
```

Description

`hbtracker = vision.HistogramBasedTracker` returns a tracker that tracks an object by using the CAMShift algorithm. It uses the histogram of pixel values to identify the tracked object. To initialize the tracking process, you must use the `initializeObject` function to specify an exemplar image of the object.

`hbtracker = vision.HistogramBasedTracker(Name,Value)` sets properties using one or more name-value pairs. Enclose each property name in quotes. For example, `hbtracker = vision.HistogramBasedTracker('ObjectHistogram',[])`

Properties

Unless otherwise indicated, properties are *nontunable*, which means you cannot change their values after calling the object. Objects lock when you call them, and the `release` function unlocks them.

If a property is *tunable*, you can change its value at any time.

For more information on changing property values, see [System Design in MATLAB Using System Objects](#).

ObjectHistogram — Normalized pixel value histogram

`[]` (default) | *N*-element vector.

Normalized pixel value histogram, specified as an N -element vector. This vector specifies the normalized histogram of the object's pixel values. Histogram values must be normalized to a value between 0 and 1. You can use the `initializeObject` method to set the property.

Tunable: Yes

Usage

Syntax

```
bbox = hbtracker(I)
[bbox,orientation] = hbtracker(I)
[bbox,orientation,score] = hbtracker(I)
```

Description

`bbox = hbtracker(I)` returns a bounding box, of the tracked object. Before using the tracker, you must identify the object to track, and set the initial search window. Use the `initializeObject` function to do this.

`[bbox,orientation] = hbtracker(I)` additionally returns the angle between the x-axis and the major axis of the ellipse that has the same second-order moments as the object. The returned angle is between $-\pi/2$ and $\pi/2$.

`[bbox,orientation,score] = hbtracker(I)` additionally returns the confidence score for the returned bounding box that contains the tracked object.

Input Arguments

I — Video frame

grayscale | 2-D feature map

Video frame, specified as grayscale or any 2-D feature map that distinguishes the object from the background. For example, I can be a hue channel of the HSV color space.

Output Arguments

bbox — Bounding box

[x y width height]

Bounding box, returned as a four-element vector in the format, *[x y width height]*.

orientation — Orientation

angle

Orientation, returned as an angle between $-\pi/2$ and $\pi/2$. The angle is measured from the x-axis and the major axis of the ellipse that has the same second-order moments as the object.

score — Score

scalar

Score, returned as a scalar in the range [0 1]. A value of 1 corresponds to the maximum confidence. 1.

Object Functions

To use an object function, specify the System object as the first input argument. For example, to release system resources of a System object named `obj`, use this syntax:

```
release(obj)
```

Specific to vision.HistogramBasedTracker

```
initializeObject      Set object to track
initializeSearchWindow Set initial search window
```

Common to All System Objects

```
step      Run System object algorithm
release   Release resources and allow changes to System object property values and input
          characteristics
reset     Reset internal states of System object
```

Examples

Track a Face

Track and display a face in each frame of an input video.

Create System objects for reading and displaying video and for drawing a bounding box of the object.

```
videoReader = VideoReader('vipcolorsegmentation.avi');
videoPlayer = vision.VideoPlayer();
shapeInserter = vision.ShapeInserter('BorderColor','Custom', ...
    'CustomBorderColor',[1 0 0]);
```

Read the first video frame, which contains the object. Convert the image to HSV color space. Then define and display the object region.

```
objectFrame = im2single(readFrame(videoReader));
objectHSV = rgb2hsv(objectFrame);
objectRegion = [40, 45, 25, 25];
objectImage = shapeInserter(objectFrame, objectRegion);
```

```
figure
imshow(objectImage)
title('Red box shows object region')
```

Red box shows object region

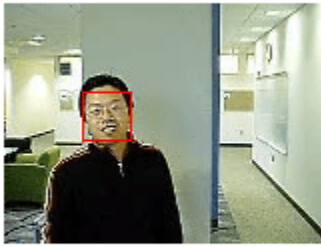

(Optionally, you can select the object region using your mouse. The object must occupy the majority of the region. Use the following command.)

```
figure; imshow(objectFrame); objectRegion=round(getPosition(imrect))
```

Set the object, based on the hue channel of the first video frame.

```
tracker = vision.HistogramBasedTracker;  
initializeObject(tracker, objectHSV(:,:,1) , objectRegion);
```

Track and display the object in each video frame. The while loop reads each image frame, converts the image to HSV color space, then tracks the object in the hue channel where it is distinct from the background. Finally, the example draws a box around the object and displays the results.

```
while hasFrame(videoReader)  
    frame = im2single(readFrame(videoReader));  
    hsv = rgb2hsv(frame);  
    bbox = tracker(hsv(:,:,1));  
  
    out = shapeInserter(frame,bbox);  
    videoPlayer(out);  
end
```

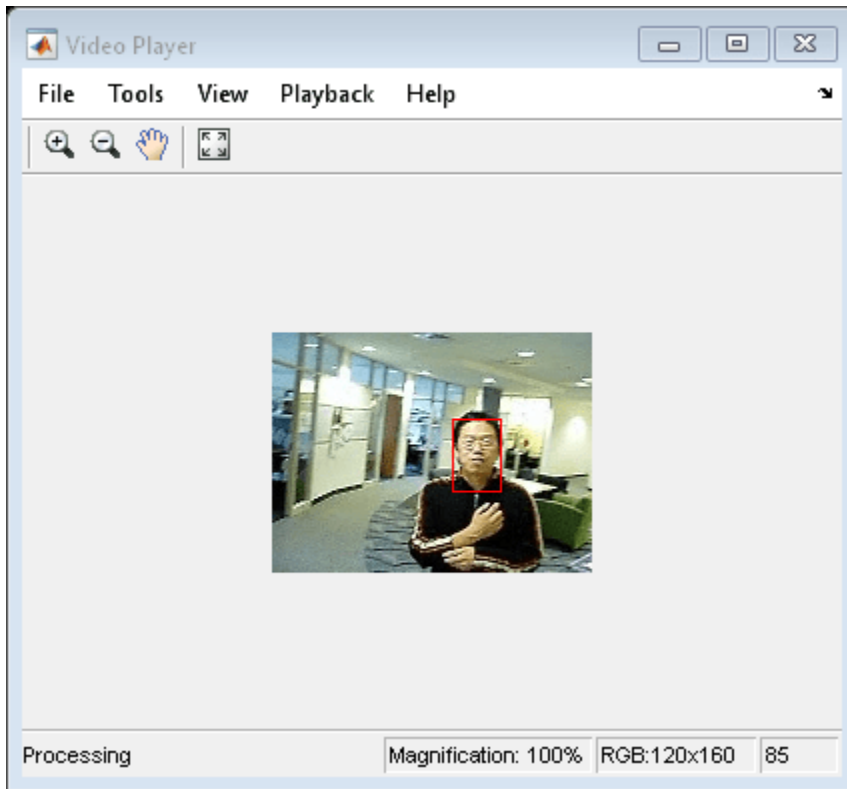

Release the video player.

```
release(videoPlayer);
```

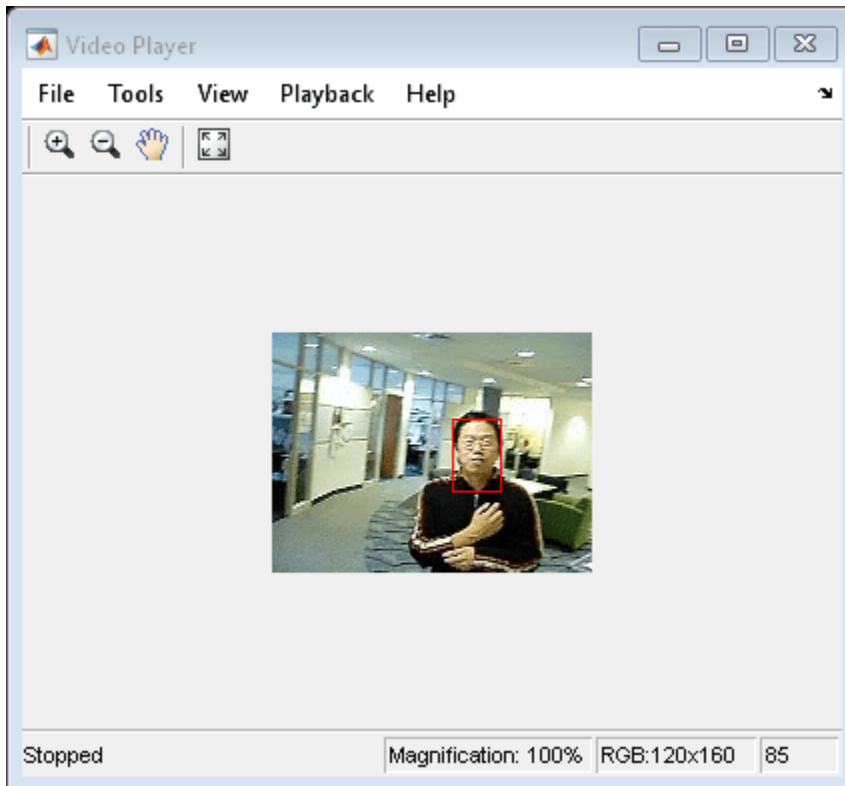

References

- [1] Bradsky, G.R. "Computer Vision Face Tracking For Use in a Perceptual User Interface." *Intel Technology Journal*. January 1998.

Extended Capabilities

C/C++ Code Generation

Generate C and C++ code using MATLAB® Coder™.

Usage notes and limitations:

- See "System Objects in MATLAB Code Generation" (MATLAB Coder).

See Also

Functions

size | imrect | rgb2hsv

Introduced in R2012a

integralKernel

Define filter for use with integral images

Description

An `integralKernel` object describes box filters for use with integral images.

Creation

Syntax

```
intKernel = integralKernel(bbox,weights)
intKernel = integralKernel(bbox,weights,orientation)
```

Description

`intKernel = integralKernel(bbox,weights)` creates an upright box filter from bounding boxes, `bbox`, and their corresponding weights, `weights`. The bounding boxes set the “BoundingBoxes” on page 2-0 property and the weights set the “Weights” on page 2-0 property.

For example, a conventional filter with the coefficients:

```
h = [1  1  1  1;
     1  1  1  1;
     -1 -1 -1 -1;
     -1 -1 -1 -1]
```

and two regions:

region 1: `x=1, y=1, width = 4, height = 2`

region 2: `x=1, y=3, width = 4, height = 2`

can be specified as

```
boxH = integralKernel([1 1 4 2; 1 3 4 2],[1, -1])
```

`intKernel = integralKernel(bbox,weights,orientation)` creates a box filter with an upright or rotated orientation. The specified orientation sets the “Orientation” on page 2-0 property.

Properties

BoundingBoxes — Bounding boxes

4-element vector | M -by-4 matrix

Bounding boxes, specified as a 4-element vector of the form `[x,y,width,height]` representing a single bounding box or an M -by-4 matrix representing M bounding boxes. The bounding boxes define the

filter. The (x,y) coordinates represent the top-most corner of the kernel. The $(width, height)$ elements represent the width and height accordingly. Specifying the bounding boxes as an M -by-4 matrix is particularly useful for constructing Haar-like features composed of multiple rectangles.

Sums are computed over regions defined by `BoundingBoxes`. The bounding boxes can overlap. See “Define an 11-by-11 Average Filter” on page 2-542 for an example of how to specify a box filter.

Weights – Weights

numeric vector

Weights, specified as an M -element numeric vector containing a weight for each bounding box. The weights are used to define the coefficients of the filter.

Coefficients – Filter coefficients

numeric

Filter coefficients, specified as a numeric value.

Center – Filter center

$[x,y]$ coordinates

Filter center, specified as $[x,y]$ coordinates. The filter center represents the center of the bounding rectangle. It is calculated by halving the dimensions of the rectangle. For even dimensional rectangles, the center is placed at subpixel locations. Hence, it is rounded up to the next integer.

For example, for this filter, the center is at $[3,3]$.

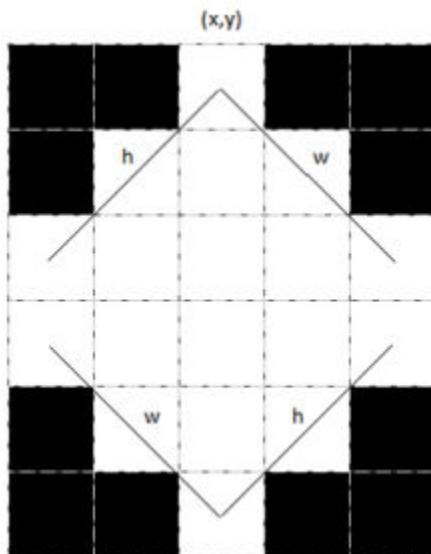

These coordinates are in the kernel space, where the top-left corner is $(1,1)$. To place the center in a different location, provide the appropriate bounding box specification. For this filter, the best workflow would be to construct the upright kernel and then call the `rot45` method to provide the rotated version.

Size – Filter size

2-element vector

Filter size, specified as a 2-element vector. The size of the kernel is computed to be the dimensions of the rectangle that bounds the kernel. For a single bounding box vector $[x,y,width,height]$, the kernel is bounded within a rectangle of dimensions $[(width+height)(width+height)-1]$.

For cascaded rectangles, the lowest corner of the bottom-most rectangle defines the size. For example, a filter with a bounding box specification of $[3\ 1\ 3\ 3]$, with weights set to 1, produces a 6-by-5 filter with this kernel:

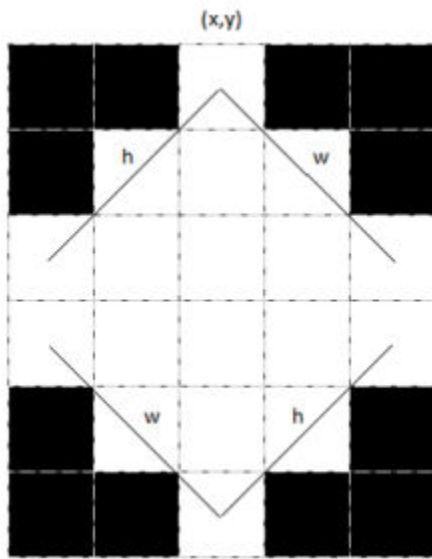

Orientation — Filter orientation

'upright' (default) | 'rotated'

Filter orientation, specified as 'upright' or 'rotated'. When you specify the orientation as 'rotated', the (x,y) components refer to the location of the top-left corner of the bounding box. Also, the $(width,height)$ components refer to a 45-degree line from the top-left corner of the bounding box.

More About

Computing an Integral Image and Using it for Filtering with Box Filters

The `integralImage` function together with the `integralKernel` object and `integralFilter` function complete the workflow for box filtering based on integral images. You can use this workflow for filtering with box filters.

- Use the `integralImage` function to compute the integral images
- Use the `integralFilter` function for filtering
- Use the `integralKernel` object to define box filters

The `integralKernel` object allows you to transpose the filter. You can use this to aim a directional filter. For example, you can turn a horizontal edge detector into vertical edge detector.

Object Functions

rot45 Rotate upright kernel clockwise by 45 degrees
 transpose Transpose integral kernel

Examples

Define an 11-by-11 Average Filter

```
avgH = integralKernel([1 1 11 11], 1/11^2);
```

Define a Filter to Approximate a Gaussian Second Order Partial Derivative in Y Direction

```
ydH = integralKernel([1,1,5,9;1,4,5,3], [1, -3]);
```

You can also define this filter as `integralKernel([1,1,5,3;1,4,5,3;1,7,5,3], [1, -2, 1]);`. This filter definition is less efficient because it requires three bounding boxes.

Visualize the filter.

```
ydH.Coefficients
```

```
ans = 9×5
```

```

1     1     1     1     1
1     1     1     1     1
1     1     1     1     1
-2    -2    -2    -2    -2
-2    -2    -2    -2    -2
-2    -2    -2    -2    -2
1     1     1     1     1
1     1     1     1     1
1     1     1     1     1
```

Create a Haar-like Wavelet to Detect 45-Degree Edges

Create the filter.

```
K = integralKernel([3,1,3,3;6 4 3 3], [1 -1], 'rotated');
```

Visualize the filter and mark the center.

```

imshow(K.Coefficients, [], 'InitialMagnification', 'fit');
hold on;
plot(K.Center(2),K.Center(1), 'r*');
impixelregion;
```

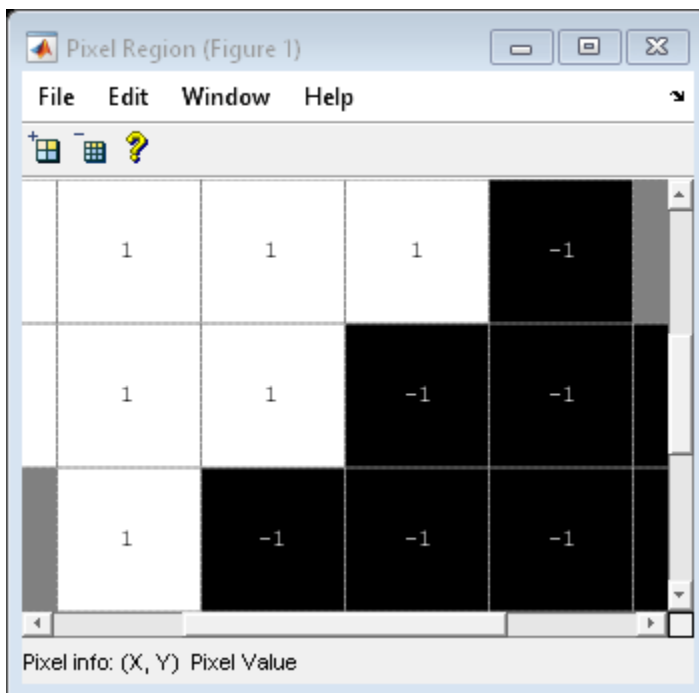
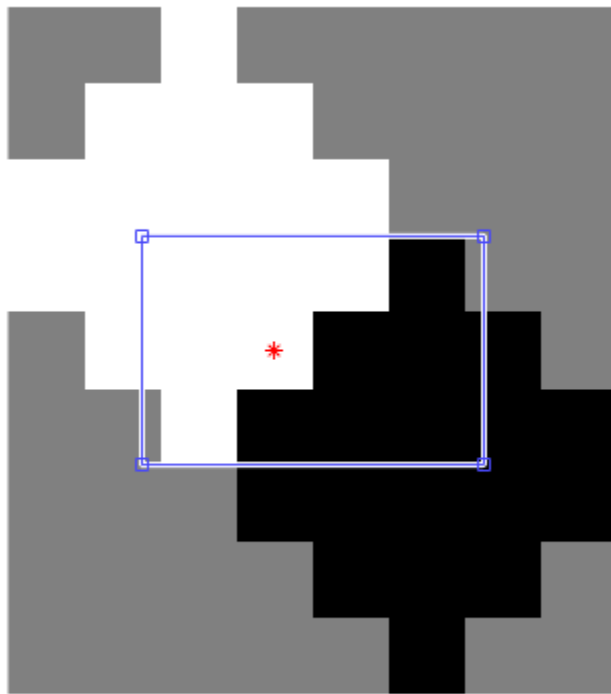

Blur an Image Using an Average Filter

Read and display the input image.

```
I = imread('pout.tif');  
imshow(I);
```



Compute the integral image.

```
intImage = integralImage(I);
```

Apply a 7-by-7 average filter.

```
avgH = integralKernel([1 1 7 7], 1/49);  
J = integralFilter(intImage, avgH);
```

Cast the result back to the same class as the input image.

```
J = uint8(J);  
figure  
imshow(J);
```



References

- [1] Viola, Paul, and Michael J. Jones. "Rapid Object Detection using a Boosted Cascade of Simple Features". Proceedings of the 2001 IEEE Computer Society Conference on Computer Vision and Pattern Recognition. Vol. 1, 2001, pp. 511-518.

See Also

[detectMSERFeatures](#) | [integralImage](#) | [integralFilter](#) | [detectSURFFeatures](#) | [SURFPoints](#)

Introduced in R2012a

transpose

Transpose integral kernel

Syntax

```
transposedKernel = transpose(intKernel)
```

Description

`transposedKernel = transpose(intKernel)` transposes the integral kernel. You can use this operation to change the direction of an oriented filter.

Examples

Construct Haar-like Wavelet Filters

Horizontal filter

```
horiH = integralKernel([1 1 4 3; 1 4 4 3], [-1, 1]);
```

Using the dot and apostrophe create a vertical filter.

```
vertH = horiH.';
```

Using the transpose method.

```
verticalH = transpose(horiH);
```

Input Arguments

intKernel – Integral kernel

`integralKernel` object

Integral kernel, specified as an `integralKernel` object.

Output Arguments

transposedKernel – Transposed integral kernel

`integralKernel` object

Transposed integral kernel, returned as an `integralKernel` object.

See Also

`rot45`

Introduced in R2012a

rot45

Rotate upright kernel clockwise by 45 degrees

Syntax

```
rotKernel = rot45(intKernel)
```

Description

`rotKernel = rot45(intKernel)` rotates upright kernel `intKernel` clockwise by 45 degrees.

Examples

Construct and Rotate a Haar-like Wavelet Filter

Create a horizontal filter.

```
H = integralKernel([1 1 4 3; 1 4 4 3], [-1, 1]);
```

Rotate the filter 45 degrees.

```
rotH = rot45(H);
```

Input Arguments

intKernel – Integral kernel

`integralKernel` object

Integral kernel, specified as an `integralKernel` object.

Output Arguments

rotKernel – Rotated integral kernel

`integralKernel` object

Rotated integral kernel, returned as an `integralKernel` object.

See Also

`transpose`

Introduced in R2012a

vision.KalmanFilter

Correction of measurement, state, and state estimation error covariance

Description

The Kalman filter object is designed for tracking. You can use it to predict a physical object's future location, to reduce noise in the detected location, or to help associate multiple physical objects with their corresponding tracks. A Kalman filter object can be configured for each physical object for multiple object tracking. To use the Kalman filter, the object must be moving at constant velocity or constant acceleration.

Creation

The Kalman filter algorithm involves two steps, prediction and correction (also known as the update step). The first step uses previous states to predict the current state. The second step uses the current measurement, such as object location, to correct the state. The Kalman filter implements a discrete time, linear State-Space System.

Note To make configuring a Kalman filter easier, you can use the `configureKalmanFilter` object to configure a Kalman filter. It sets up the filter for tracking a physical object in a Cartesian coordinate system, moving with constant velocity or constant acceleration. The statistics are the same along all dimensions. If you need to configure a Kalman filter with different assumptions, do not use the function, use this object directly.

In the state space system, the state transition model, A , and the measurement model, H , are set as follows:

Variable	Value
A	[1 1 0 0; 0 1 0 0; 0 0 1 1; 0 0 0 1]
H	[1 0 0 0; 0 0 1 0]

Syntax

```
kalmanFilter = vision.KalmanFilter
kalmanFilter = vision.KalmanFilter(StateTransitionModel,MeasurementModel)
kalmanFilter = vision.KalmanFilter(StateTransitionModel,MeasurementModel,
ControlModel,Name,Value)
```

Description

`kalmanFilter = vision.KalmanFilter` returns a kalman filter for a discrete time, constant velocity system.

`kalmanFilter = vision.KalmanFilter(StateTransitionModel,MeasurementModel)` additionally configures the control model, B .

`kalmanFilter = vision.KalmanFilter(StateTransitionModel, MeasurementModel, ControlModel, Name, Value)` configures the Kalman filter object properties, specified as one or more `Name, Value` pair arguments. Unspecified properties have default values.

Properties

StateTransitionModel — Model describing state transition between time steps (A)

[1 1 0 0; 0 1 0 0; 0 0 1 1; 0 0 0 1] (default) | M -by- M matrix

Model describing state transition between time steps (A), specified as an M -by- M matrix. After the object is constructed, this property cannot be changed. This property relates to the A variable in the state-space model.

MeasurementModel — Model describing state to measurement transformation (H)

[1 0 0 0; 0 0 1 0] (default) | N -by- M matrix

Model describing state to measurement transformation (H), specified as an N -by- M matrix. After the object is constructed, this property cannot be changed. This property relates to the H variable in the state-space model.

ControlModel — Model describing control input to state transformation (B)

[] (default) | M -by- L matrix

Model describing control input to state transformation (B), specified as an M -by- L matrix. After the object is constructed, this property cannot be changed. This property relates to the B variable in the state-space model.

State — State (x)

[0] (default) | scalar | M -element vector

State (x), specified as a scalar or an M -element vector. If you specify State as a scalar, it will be extended to an M -element vector. This property relates to the x variable in the state-space model.

StateCovariance — State estimation error covariance (P)

[1] (default) | scalar | M -by- M matrix

State estimation error covariance (P), specified as a scalar or an M -by- M matrix. If you specify StateCovariance as a scalar it will be extended to an M -by- M diagonal matrix. This property relates to the P variable in the state-space system.

ProcessNoise — Process noise covariance (Q)

[1] (default) | scalar | M -by- M matrix

Process noise covariance (Q), specified as a scalar or an M -by- M matrix. If you specify ProcessNoise as a scalar it will be extended to an M -by- M diagonal matrix. This property relates to the Q variable in the state-space model.

MeasurementNoise — Measurement noise covariance (R)

[1] (default) | scalar | N -by- N matrix

Measurement noise covariance (R), specified as a scalar or an N -by- N matrix. If you specify MeasurementNoise as a scalar it will be extended to an N -by- N diagonal matrix. This property relates to the R variable in the state-space model.

Object Functions

Use the `predict` and `correct` functions based on detection results. Use the `distance` function to find the best matches.

- When the tracked object is detected, use the `predict` and `correct` functions with the Kalman filter object and the detection measurement. Call the functions in the following order:

```
[...] = predict(kalmanFilter);
[...] = correct(kalmanFilter,measurement);
```

- When the tracked object is not detected, call the `predict` function, but not the `correct` function. When the tracked object is missing or occluded, no measurement is available. Set the functions up with the following logic:

```
[...] = predict(kalmanFilter);
If measurement exists
    [...] = correct(kalmanFilter,measurement);
end
```

- If the tracked object becomes available after missing for the past $t-1$ contiguous time steps, you can call the `predict` function t times. This syntax is particularly useful to process asynchronous video.. For example,

```
for i = 1:k
    [...] = predict(kalmanFilter);
end
[...] = correct(kalmanFilter,measurement)
```

`correct` Correction of measurement, state, and state estimation error covariance
`predict` Prediction of measurement
`distance` Confidence value of measurement

Examples

Track Location of An Object

Track the location of a physical object moving in one direction.

Generate synthetic data which mimics the 1-D location of a physical object moving at a constant speed.

```
detectedLocations = num2cell(2*randn(1,40) + (1:40));
```

Simulate missing detections by setting some elements to empty.

```
detectedLocations{1} = [];
for idx = 16: 25
    detectedLocations{idx} = [];
end
```

Create a figure to show the location of detections and the results of using the Kalman filter for tracking.

```
figure;
hold on;
```

```

ylabel('Location');
ylim([0,50]);
xlabel('Time');
xlim([0,length(detectedLocations)]);

```

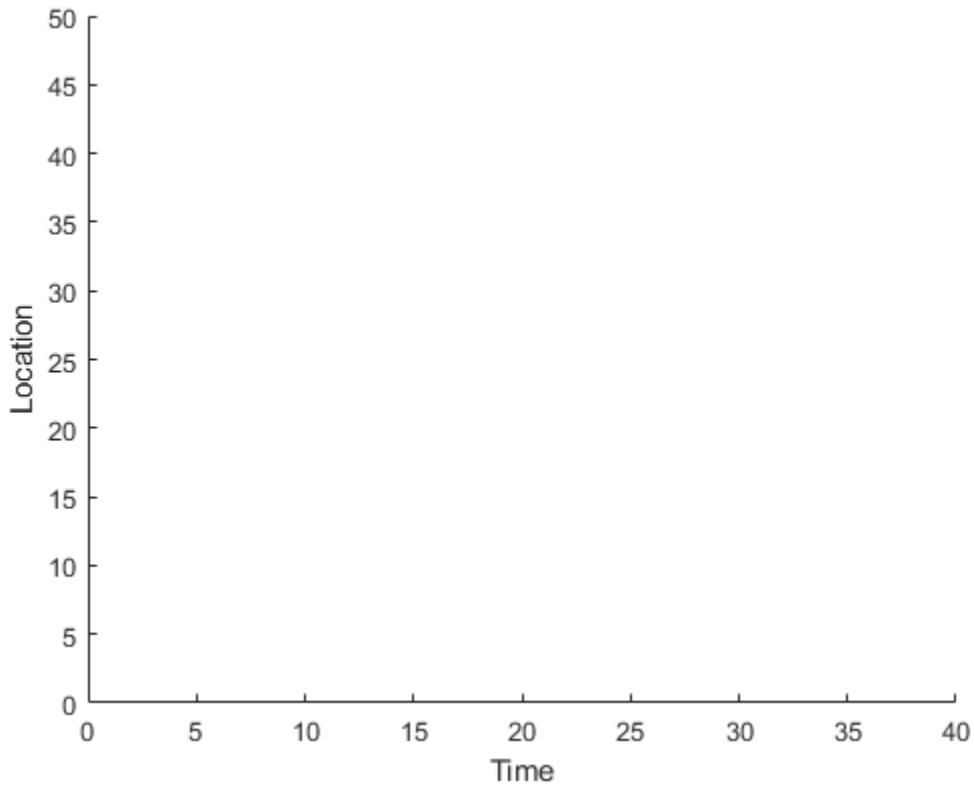

Create a 1-D, constant speed Kalman filter when the physical object is first detected. Predict the location of the object based on previous states. If the object is detected at the current time step, use its location to correct the states.

```

kalman = [];
for idx = 1:length(detectedLocations)
    location = detectedLocations{idx};
    if isempty(kalman)
        if ~isempty(location)
            stateModel = [1 1;0 1];
            measurementModel = [1 0];
            kalman = vision.KalmanFilter(stateModel,measurementModel,'ProcessNoise',1e-4,'MeasurementNoise',1e-4);
            kalman.State = [location, 0];
        end
    else
        trackedLocation = predict(kalman);
        if ~isempty(location)
            plot(idx, location,'k+');
            d = distance(kalman,location);
            title(sprintf('Distance:%f', d));
            trackedLocation = correct(kalman,location);
        end
    end
end

```

```

else
    title('Missing detection');
end
pause(0.2);
plot(idx,trackedLocation,'ro');
end
end
legend('Detected locations','Predicted/corrected locations');

```

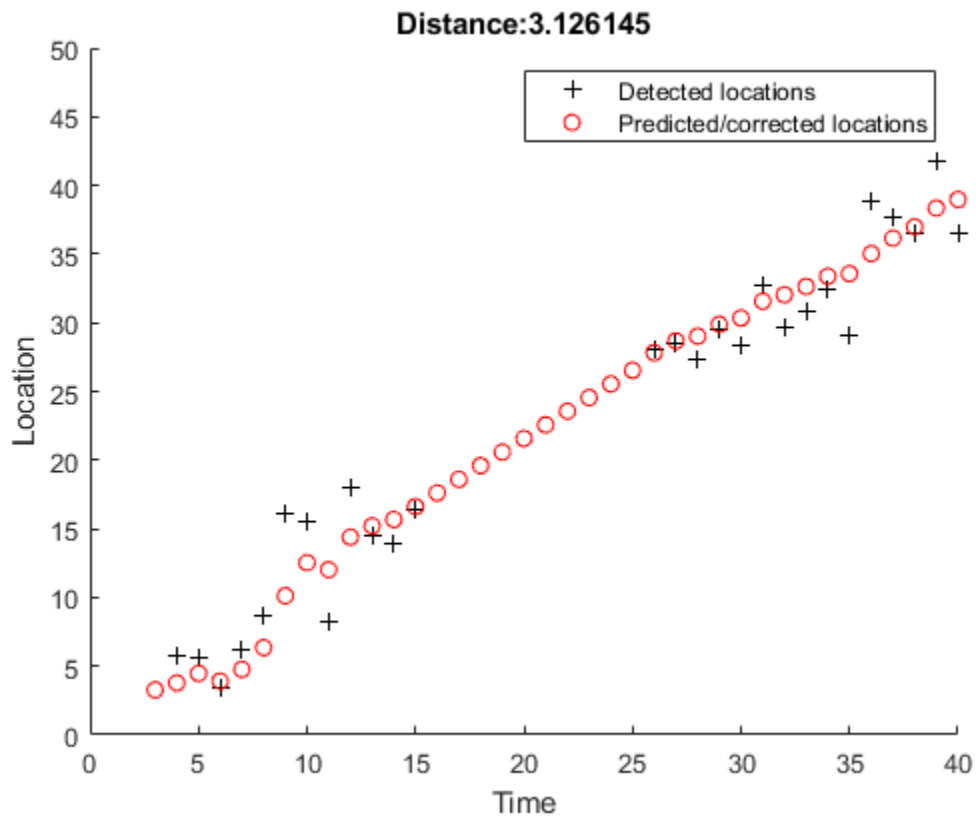

Remove Noise From a Signal

Use Kalman filter to remove noise from a random signal corrupted by a zero-mean Gaussian noise.

Synthesize a random signal that has value of 1 and is corrupted by a zero-mean Gaussian noise with standard deviation of 0.1.

```

x = 1;
len = 100;
z = x + 0.1 * randn(1,len);

```

Remove noise from the signal by using a Kalman filter. The state is expected to be constant, and the measurement is the same as state.

```

stateTransitionModel = 1;
measurementModel = 1;

```

```

obj = vision.KalmanFilter(stateTransitionModel,measurementModel,'StateCovariance',1,'ProcessNoise');
z_corr = zeros(1,len);
for idx = 1: len
    predict(obj);
    z_corr(idx) = correct(obj,z(idx));
end

```

Plot results.

```

figure, plot(x * ones(1,len),'g-');
hold on;
plot(1:len,z,'b+',1:len,z_corr,'r-');
legend('Original signal','Noisy signal','Filtered signal');

```

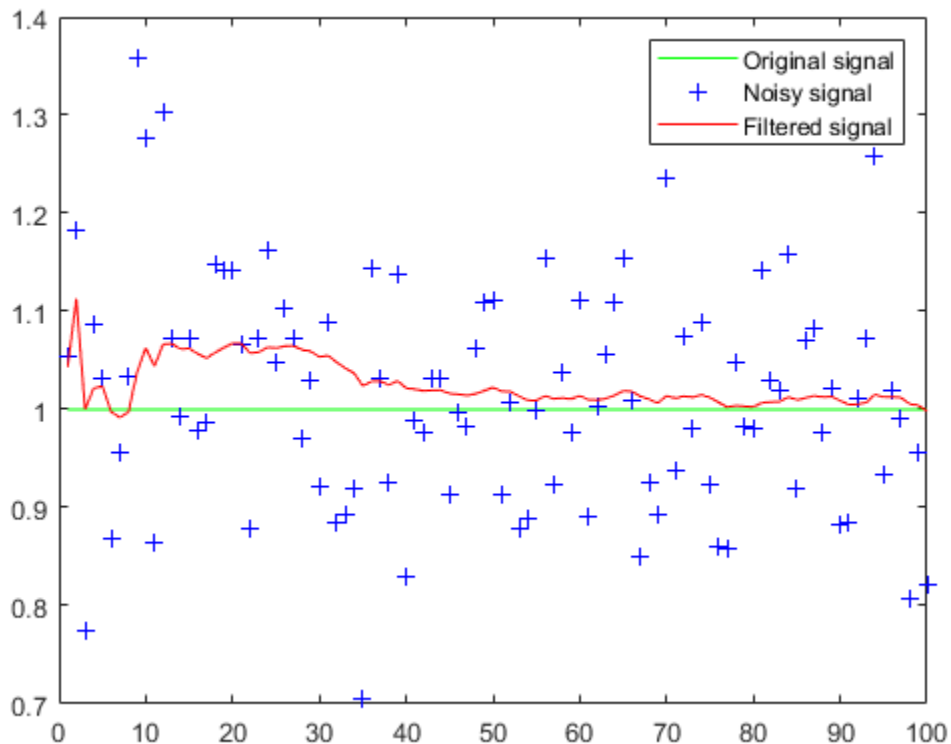

Algorithms

State Space Model

This object implements a discrete time, linear state-space system, described by the following equations.

State equation:	$x(k) = Ax(k - 1) + Bu(k - 1) + w(k - 1)$
Measurement equation:	$z(k) = Hx(k) + v(k)$

Variable Definition

Variable	Description	Dimension
k	Time.	Scalar
x	State. Gaussian vector with covariance P . [$x \sim N(\bar{x}, P)$]	M -element vector
P	State estimation error covariance.	M -by- M matrix
A	State transition model.	M -by- M matrix
B	Control model.	M -by- L matrix
u	Control input.	L -element vector
w	Process noise; Gaussian vector with zero mean and covariance Q . [$w \sim N(0, Q)$]	M -element vector
Q	Process noise covariance.	M -by- M matrix
z	Measurement. For example, location of detected object.	N -element vector
H	Measurement model.	N -by- M matrix
v	Measurement noise; Gaussian vector with zero mean and covariance R . [$v \sim N(0, R)$]	N -element vector
R	Measurement noise covariance.	N -by- N matrix

References

- [1] Welch, Greg, and Gary Bishop, *An Introduction to the Kalman Filter*, TR 95-041. University of North Carolina at Chapel Hill, Department of Computer Science.
- [2] Blackman, S. *Multiple-Target Tracking with Radar Applications*. Artech House, Inc., pp. 93, 1986.

Extended Capabilities**C/C++ Code Generation**

Generate C and C++ code using MATLAB® Coder™.

Usage notes and limitations:

- See “System Objects in MATLAB Code Generation” (MATLAB Coder).

See Also**Functions**

`configureKalmanFilter` | `assignDetectionsToTracks`

Introduced in R2012b

vision.LocalMaximaFinder

Package: vision

Find local maxima in matrices

Description

To find local maxima in matrices.

- 1 Create the `vision.LocalMaximaFinder` object and set its properties.
- 2 Call the object with arguments, as if it were a function.

To learn more about how System objects work, see [What Are System Objects?](#)

Creation

Syntax

```
LMaxFinder = vision.LocalMaximaFinder
LMaxFinder = vision.LocalMaximaFinder(maxnum,neighborsize)
LMaxFinder = vision.LocalMaximaFinder(Name,Value)
```

Description

`LMaxFinder = vision.LocalMaximaFinder` returns a local maxima finder System object, `H`, that finds local maxima in input matrices.

`LMaxFinder = vision.LocalMaximaFinder(maxnum,neighborsize)` returns a local maxima finder object with the `MaximumNumLocalMaxima` property set to `maxnum`, `NeighborhoodSize` property set to `neighborsize`, and other specified properties set to the specified values.

`LMaxFinder = vision.LocalMaximaFinder(Name,Value)` sets properties using one or more name-value pairs. Enclose each property name in quotes. For example, `LMaxFinder = vision.LocalMaximaFinder('ThresholdSource','Property')`

Properties

Unless otherwise indicated, properties are *nontunable*, which means you cannot change their values after calling the object. Objects lock when you call them, and the `release` function unlocks them.

If a property is *tunable*, you can change its value at any time.

For more information on changing property values, see [System Design in MATLAB Using System Objects](#).

MaximumNumLocalMaxima — Maximum number of maxima

2 (default) | positive scalar integer

Maximum number of maxima to find, specified as a positive scalar integer.

NeighborhoodSize — Neighborhood size for zero-ing out values

[5 7] (default) | two-element vector

Neighborhood size for zero-ing out values, specified as a two-element vector

ThresholdSource — Source of threshold

'Property' (default) | 'Input port'

Source of threshold, specified as 'Property' or 'Input port'.

Threshold — Value that all maxima should match or exceed

10 (default) | build-in numeric data type

Value that all maxima should match or exceed, specified as a scalar of MATLAB built-in numeric data type. This property applies when you set the ThresholdSource property to 'Property'.

Tunable: Yes

HoughMatrixInput — Indicator of Hough transform matrix input

false (default) | true

Indicator of Hough transform matrix input, specified as true or false. The block applies additional processing, specific to Hough transform on the right and left boundaries of the input matrix. Set this property to true if the input is antisymmetric about the rho axis and the theta value ranges from $-\frac{\pi}{2}$ to $\frac{\pi}{2}$ radians, which correspond to a Hough matrix.

IndexDataType — Data type of index values

uint32 (default) | double | single | uint8 | uint16

Data type of index values, specified as double, single, uint8, uint16, or uint32.

Usage

Syntax

```
idx = LMaxFinder(I)
idx = LMaxFinder(I, threshold)
```

Description

`idx = LMaxFinder(I)` returns [x y] coordinates of the local maxima in an M -by-2 matrix, `idx`. M represents the number of local maxima found. The maximum value of M may not exceed the value set in the `MaximumNumLocalMaxima` property.

`idx = LMaxFinder(I, threshold)` finds the local maxima in the input image `I`, using the threshold value `threshold`, when you set the ThresholdSource property to 'Input port'.

Input Arguments

I — Video frame

grayscale | truecolor (RGB)

Video frame, specified as grayscale or truecolor (RGB).

threshold — Threshold

scalar

Value that all maxima should match or exceed, specified as a scalar of MATLAB built-in numeric data type.

Output Arguments

idx — Local maxima

M-by-2 matrix

Local maxima, returned as an *M*-by-2 matrix of one-based [*x y*] coordinates, where *M* represents the number of local maximas found.

Object Functions

To use an object function, specify the System object as the first input argument. For example, to release system resources of a System object named *obj*, use this syntax:

```
release(obj)
```

Specific to vision.LocalMaximaFinder

initialize Initialize video frame and points to track

Common to All System Objects

step Run System object algorithm

release Release resources and allow changes to System object property values and input characteristics

reset Reset internal states of System object

Examples

Find Local Maxima of an Input

Create an example input.

```
I = [0 0 0 0 0 0 0 0 0 0 0 0; ...
     0 0 0 1 1 2 3 2 1 1 0 0; ...
     0 0 0 1 2 3 4 3 2 1 0 0; ...
     0 0 0 1 3 5 7 5 3 1 0 0; ...
     0 0 0 1 2 3 4 3 2 1 0 0; ...
     0 0 0 1 1 2 3 2 1 1 0 0; ...
     0 0 0 0 0 0 0 0 0 0 0 0];
```

Create a local maxima finder object.

```
hLocalMax = vision.LocalMaximaFinder('MaximumNumLocalMaxima',1, ...
                                     'NeighborhoodSize',[3,3], ...
                                     'Threshold',1);
```

Find local maxima.

```
location = hLocalMax(I)
```

```
location = 1x2 uint32 row vector
```

```
    7    4
```

Extended Capabilities

C/C++ Code Generation

Generate C and C++ code using MATLAB® Coder™.

Usage notes and limitations:

- Generates portable C code using a C++ compiler that links to OpenCV (Version 3.4.0) libraries. See “Portable C Code Generation for Functions That Use OpenCV Library”.
- See “System Objects in MATLAB Code Generation” (MATLAB Coder).

See Also

`hough` | `vision.Maximum`

Introduced in R2012b

vision.Maximum

Package: vision

Find maximum values in input or sequence of inputs

Description

Find maximum values in an input or sequence of inputs.

To track a set of points:

- 1 Create the `vision.Maximum` object and set its properties.
- 2 Call the object with arguments, as if it were a function.

To learn more about how System objects work, see [What Are System Objects?](#)

Creation

Syntax

```
maxObj = vision.Maximum
maxObj = vision.Maximum(Name,Value)
```

Description

`maxObj = vision.Maximum` returns an object, `maxObj`, that computes the value and index of the maximum elements in an input or a sequence of inputs.

`maxObj = vision.Maximum(Name,Value)` sets properties using one or more name-value pairs. Enclose each property name in quotes. For example, `maxObj = vision.Maximum('RunningMaximum',false)`

Properties

Unless otherwise indicated, properties are *nontunable*, which means you cannot change their values after calling the object. Objects lock when you call them, and the `release` function unlocks them.

If a property is *tunable*, you can change its value at any time.

For more information on changing property values, see [System Design in MATLAB Using System Objects](#).

ValueOutputPort — Output maximum value

true (default) | false

Output maximum value, specified as `true` or `false`. Set this property to `true` to output the maximum value of the input. This property applies when you set the `RunningMaximum` property to `false`.

RunningMaximum — Calculate over single input or multiple inputs`false (default) | true`

Calculate over single input or multiple inputs, specified as `true` or `false`. When you set this property to `true`, the object computes the maximum value over a sequence of inputs. When you set this property to `false`, the object computes the maximum value over the current input.

IndexOutputPort — Output the index of the maximum value`true (default) | false`

Output the index of the maximum value, specified as `true` or `false`. This property applies only when you set the `RunningMaximum` property to `false`.

ResetInputPort — Additional input to enable resetting of running maximum`false (default) | true`

Additional input to enable resetting of running maximum, specified as `true` or `false`. When you set this property to `true`, a reset input must be specified to reset the running maximum. This property applies only when you set the `RunningMaximum` property to `true`.

ResetCondition — Condition that triggers resetting of running maximum`'Non-zero' (default) | 'Rising edge' | 'Falling edge' | 'Either edge'`

Condition that triggers resetting of running maximum, specified as `'Rising edge'`, `'Falling edge'`, `'Either edge'`, or `'Non-zero'`. This property applies only when you set the `ResetInputPort` property to `true`.

IndexBase — Numbering base for index of maximum value`'One' (default) | 'Zero'`

Numbering base for index of maximum value, specified as `'One'` or `'Zero'`. This property applies only when you set the `IndexOutputPort` property to `true`.

Dimension — Dimension to operate along`'Column' (default) | {'All'} | 'Row' | 'Custom'`

Dimension to operate along, specified as `{'All'}`, `'Row'`, `'Column'`, or `'Custom'`. This property applies only when you set the `RunningMaximum` property to `false`.

CustomDimension — Numerical dimension to calculate over`1 (default) | numerical scalar`

Numerical dimension to calculate over, specified as a numerical scalar. This property only applies when you set the `Dimension` property to `'Custom'`.

ROIProcessing — Enable region-of-interest processing`false (default) | true`

Enable region-of-interest processing, specified as `true` or `false`. This property applies when you set the `Dimension` property to `'All'` and the `RunningMaximum` property to `false`.

ROIForm — Type of ROI`'Rectangles' (default) | 'Lines' | 'Label matrix' | 'Binary mask'`

Type of ROI, specified as `'Rectangles'`, `'Lines'`, `'Label matrix'`, or `'Binary mask'`. This property applies only when you set the `ROIProcessing` property to `true`.

ROIPortion — ROI or perimeter calculation`'Entire ROI' (default) | 'ROI perimeter'`

ROI or perimeter calculation, specified as 'Entire ROI' or 'ROI perimeter'. This property applies only when you set the ROIForm property to 'Rectangles'.

ROIStatistics — Calculate statistics for each ROI or one for all ROIs`'Individual statistics for each ROI' (default) | 'Single statistic for all ROIs'`

Calculate statistics for each ROI or one for all ROIs, specified as 'Individual statistics for each ROI' or 'Single statistic for all ROIs'. This property applies only when you set the ROIForm property to 'Rectangles', 'Lines', or 'Label matrix'.

ValidityOutputPort — Flag to indicate if any part of ROI is outside input image`false (default) | true`

Flag to indicate if any part of ROI is outside input image, specified as true or false.

This applies when you set the ROIForm property to 'Lines' or 'Rectangles'.

Set this property to true to return the validity of the specified label numbers. This applies when you set the ROIForm property to 'Label matrix'.

Fixed-Point Properties**RoundingMethod — Rounding method for fixed-point operations**`'Floor' (default) | 'Ceiling' | 'Convergent' | 'Nearest' | 'Round' | 'Simplest' | 'Zero'`

Rounding method for fixed-point operations, specified as 'Floor', 'Ceiling', 'Convergent', 'Nearest', 'Round', 'Simplest', or 'Zero'.

OverflowAction — Action to take when integer input is out-of-range`'Wrap' (default) | 'Saturate'`

Action to take when integer input is out-of-range, specified as 'Wrap' or 'Saturate'.

ProductDataType — Product data type`'Same as input' (default) | 'Custom'`

Product data type, specified as 'Same as input' or 'Custom'.

CustomProductDataType — Product word and fraction lengths`numericType(true,32,30) (default) | scaled numericType object`

Product word and fraction lengths, specified as a scaled numericType object. This property applies only when you set the AccumulatorDataType property to 'Custom'.

AccumulatorDataType — Data type of accumulator`'Same as product' (default) | 'Same as input' | 'Custom'`

Data type of accumulator, specified as 'Same as product', 'Same as input', or 'Custom'.

CustomAccumulatorDataType — Accumulator word and fraction lengths`numericType(true,32,30) (default) | scaled numericType object`

Accumulator word and fraction lengths, specified as a scaled numeric type object. This property applies only when you set the `AccumulatorDataType` property to 'Custom'.

Usage

Syntax

```
[value,index] = maxObj(input)  
index = maxObj(input)
```

```
[ ___ ] = maxObj(I,ROI)  
[ ___ ,flag] = maxObj(I,ROI)
```

```
[ ___ ] = maxObj(I,label,labelNumbers)  
[ ___ ,flag] = maxObj(I,label,labelNumbers)
```

Description

`[value,index] = maxObj(input)` returns the maximum value and index of the input.

`index = maxObj(input)` returns the one-based index of the maximum value when you set the `IndexOutputPort` property to `true` and the `ValueOutputPort` property to `false`. The `RunningMaximum` property must be set to `false`.

`[___] = maxObj(I,ROI)` returns the maximum value in the input image within the given region of interest.

`[___ ,flag] = maxObj(I,ROI)` additionally returns a flag to indicate whether the given ROI is within the bounds of the image.

`[___] = maxObj(I,label,labelNumbers)` returns the maximum of the input image for a region the labels specified in the `labelNumbers` vector. The regions are defined and labeled in the `label` matrix.

`[___ ,flag] = maxObj(I,label,labelNumbers)` additionally returns a flag to indicate whether the input label numbers are valid.

Input Arguments

input — Input data

vector | matrix | multidimensional array

Input data, specified as a vector, matrix, or multidimensional array.

ROI — Region of interest

four-element vector

Region of interest, specified as a four-element vector, `[x y width height]`. This option is available when you set the `ROIProcessing` property to `true` and the `ROIForm` property to 'Lines', 'Rectangles', or 'Binary Mask'.

label — Label numbers

matrix

Label numbers, specified as a matrix. This option is available when you set the `ROIProcessing` property to `true` and the `ROIForm` property to `'Label matrix'`.

LabelNumbers — Label numbers

vector

Label numbers, specified as a vector. This option is available when you set the `ROIProcessing` property to `true` and the `ROIForm` property to `'Label matrix'`.

Output Arguments

value — Maximum value

same as input

Maximum value, returned as the same data type as the input

index — Index to maximum value

one-based index

Index to maximum value, returned as a one-based index.

flag — Flag for valid data

`true` | `false`

Flag for valid data, returned as `true` or `false`.

Object Functions

To use an object function, specify the System object as the first input argument. For example, to release system resources of a System object named `obj`, use this syntax:

```
release(obj)
```

Common to All System Objects

`step` Run System object algorithm

`release` Release resources and allow changes to System object property values and input characteristics

`reset` Reset internal states of System object

Examples

Find Index to Maximum Value in Grayscale Image

Read a color image.

```
img = imread('peppers.png');
```

Convert the image to grayscale.

```
img = im2single(im2gray(img));
```

Find the maximum.

```
hMax = vision.Maximum
hMax =
  vision.Maximum with properties:
    ValueOutputPort: true
    RunningMaximum: false
    IndexOutputPort: true
    Dimension: 'All'
    ROIProcessing: false

  Show all properties

[m,ind] = hMax(img);
```

Extended Capabilities

C/C++ Code Generation

Generate C and C++ code using MATLAB® Coder™.

Usage notes and limitations:

- See “System Objects in MATLAB Code Generation” (MATLAB Coder).

See Also

[vision.Mean](#) | [vision.Minimum](#)

Introduced in R2012a

vision.Mean

Package: vision

Find mean values in input or sequence of inputs

Description

Find the mean values in an input or sequence of inputs.

To track a set of points:

- 1 Create the `vision.Mean` object and set its properties.
- 2 Call the object with arguments, as if it were a function.

To learn more about how System objects work, see [What Are System Objects?](#)

Creation

Syntax

```
minObj = vision.Mean
minObj = vision.Mean(Name,Value)
```

Description

`minObj = vision.Mean` returns an object, `minObj`, that computes the value and index of the maximum elements in an input or a sequence of inputs.

`minObj = vision.Mean(Name,Value)` sets properties using one or more name-value pairs. Enclose each property name in quotes. For example, `minObj = vision.Maximum('RunningMean',false)`

Properties

Unless otherwise indicated, properties are *nontunable*, which means you cannot change their values after calling the object. Objects lock when you call them, and the `release` function unlocks them.

If a property is *tunable*, you can change its value at any time.

For more information on changing property values, see [System Design in MATLAB Using System Objects](#).

RunningMean — Calculate over single input or multiple inputs

`false` (default) | `true`

Calculate over single input or multiple inputs, specified as `true` or `false`. When you set this property to `true`, the object computes the mean value over a sequence of inputs. When you set this property to `false`, the object computes the mean value over the current input.

ResetInputPort — Additional input to enable resetting of running mean`false (default) | true`

Additional input to enable resetting of running mean, specified as `true` or `false`. When you set this property to `true`, a reset input must be specified to reset the running mean. This property applies only when you set the `RunningMean` property to `true`.

ResetCondition — Condition that triggers resetting of running mean`'Non-zero' (default) | 'Rising edge' | 'Falling edge' | 'Either edge'`

Condition that triggers resetting of running mean, specified as `'Rising edge'`, `'Falling edge'`, `'Either edge'`, or `'Non-zero'`. This property applies only when you set the `ResetInputPort` property to `true`.

Dimension — Dimension to operate along`'Column' (default) | {'All'} | 'Row' | 'Custom'`

Dimension to operate along, specified as `{'All'}`, `'Row'`, `'Column'`, or `'Custom'`. This property applies only when you set the `RunningMean` property to `false`.

CustomDimension — Numerical dimension to calculate over`1 (default) | numerical scalar`

Numerical dimension to calculate over, specified as a numerical scalar. This property only applies when you set the `Dimension` property to `'Custom'`.

ROIProcessing — Enable region-of-interest processing`false (default) | true`

Enable region-of-interest processing, specified as `true` or `false`. This property applies when you set the `Dimension` property to `'All'` and the `RunningMean` property to `false`.

ROIForm — Type of ROI`'Rectangles' (default) | 'Lines' | 'Label matrix' | 'Binary mask'`

Type of ROI, specified as `'Rectangles'`, `'Lines'`, `'Label matrix'`, or `'Binary mask'`. This property applies only when you set the `ROIProcessing` property to `true`.

ROIPortion — ROI or perimeter calculation`'Entire ROI' (default) | 'ROI perimeter'`

ROI or perimeter calculation, specified as `'Entire ROI'` or `'ROI perimeter'`. This property applies only when you set the `ROIForm` property to `'Rectangles'`.

ROIStatistics — Calculate statistics for each ROI or one for all ROIs`'Individual statistics for each ROI' (default) | 'Single statistic for all ROIs'`

Calculate statistics for each ROI or one for all ROIs, specified as `'Individual statistics for each ROI'` or `'Single statistic for all ROIs'`. This property applies only when you set the `ROIForm` property to `'Rectangles'`, `'Lines'`, or `'Label matrix'`.

ValidityOutputPort — Flag to indicate if any part of ROI is outside input image`false (default) | true`

Flag to indicate if any part of ROI is outside input image, specified as `true` or `false`.

This applies when you set the ROIForm property to 'Lines' or 'Rectangles'.

Set this property to true to return the validity of the specified label numbers. This applies when you set the ROIForm property to 'Label matrix'.

Fixed-Point Properties

RoundingMethod — Rounding method for fixed-point operations

'Floor' (default) | 'Ceiling' | 'Convergent' | 'Nearest' | 'Round' | 'Simplest' | 'Zero'

Rounding method for fixed-point operations, specified as 'Floor', 'Ceiling', 'Convergent', 'Nearest', 'Round', 'Simplest', or 'Zero'.

OverflowAction — Action to take when integer input is out-of-range

'Wrap' (default) | 'Saturate'

Action to take when integer input is out-of-range, specified as 'Wrap' or 'Saturate'.

ProductDataType — Product data type

'Same as input' (default) | 'Custom'

Product data type, specified as 'Same as input' or 'Custom'.

CustomProductDataType — Product word and fraction lengths

numericType(true,32,30) (default) | scaled numericType object

Product word and fraction lengths, specified as a scaled numericType object. This property applies only when you set the AccumulatorDataType property to 'Custom'.

AccumulatorDataType — Data type of accumulator

'Same as product' (default) | 'Same as input' | 'Custom'

Data type of accumulator, specified as 'Same as product', 'Same as input', or 'Custom'.

CustomAccumulatorDataType — Accumulator word and fraction lengths

numericType(true,32,30) (default) | scaled numericType object

Accumulator word and fraction lengths, specified as a scaled numericType object. This property applies only when you set the AccumulatorDataType property to 'Custom'.

Usage

Syntax

```
[value,index] = minObj(input)
index = minObj(input)
```

```
[ ___ ] = minObj(I,ROI)
[ ___ ,flag] = minObj(I,ROI)
```

```
[ ___ ] = minObj(I,label,labelNumbers)
[ ___ ,flag] = minObj(I,label,labelNumbers)
```

Description

[value,index] = minObj(input) returns the mean value and index of the input.

index = minObj(input) returns the one-based index of the mean value when you set the IndexOutputPort property to true and the ValueOutputPort property to false. The RunningMean property must be set to false.

[___] = minObj(I,ROI) returns the mean value in the input image within the given region of interest.

[___ ,flag] = minObj(I,ROI) additionally returns a flag to indicate whether the given ROI is within the bounds of the image.

[___] = minObj(I,label,labelNumbers) returns the mean of the input image for a region the labels specified in the labelNumbers vector. The regions are defined and labeled in the label matrix.

[___ ,flag] = minObj(I,label,labelNumbers) additionally returns a flag to indicate whether the input label numbers are valid.

Input Arguments**input — Input data**

vector | matrix | multidimensional array

Input data, specified as a vector, matrix, or multidimensional array.

ROI — Region of interest

four-element vector

Region of interest, specified as a four-element vector, [x y width height]. This option is available when you set the ROIProcessing property to true and the ROIForm property to 'Lines', 'Rectangles', or 'Binary Mask'.

label — Label numbers

matrix

Label numbers, specified as a matrix. This option is available when you set the ROIProcessing property to true and the ROIForm property to 'Label matrix'.

labelNumbers — Label numbers

vector

Label numbers, specified as a vector. This option is available when you set the ROIProcessing property to true and the ROIForm property to 'Label matrix'.

Output Arguments**value — Mean value**

same as input

Mean value, returned as the same data type as the input

index — Index to mean value

one-based index

Index to mean value, returned as a one-based index.

flag — Flag for valid data

true | false

Flag for valid data, returned as true or false.

Object Functions

To use an object function, specify the System object as the first input argument. For example, to release system resources of a System object named `obj`, use this syntax:

```
release(obj)
```

Common to All System Objects

`step` Run System object algorithm

`release` Release resources and allow changes to System object property values and input characteristics

`reset` Reset internal states of System object

Examples

Determine the Mean in Grayscale Image

Read a color image.

```
img = imread('peppers.png');
```

Convert the image to grayscale.

```
img = im2single(im2gray(img));
```

Find the mean.

```
hMean = vision.Mean;
mean = hMean(img);
```

Extended Capabilities

C/C++ Code Generation

Generate C and C++ code using MATLAB® Coder™.

Usage notes and limitations:

- See “System Objects in MATLAB Code Generation” (MATLAB Coder).

See Also

`vision.Maximum` | `vision.Minimum`

Introduced in R2012a

vision.Median

Package: vision

Find median values in input or sequence of inputs

Description

Find the median values in an input or sequence of inputs.

To track a set of points:

- 1 Create the `vision.Median` object and set its properties.
- 2 Call the object with arguments, as if it were a function.

To learn more about how System objects work, see [What Are System Objects?](#)

Creation

Syntax

```
medObj = vision.Median
medObj = vision.Median(Name,Value)
```

Description

`medObj = vision.Median` returns an object, `medObj`, that computes the value and index of the maximum elements in an input or a sequence of inputs.

`medObj = vision.Median(Name,Value)` sets properties using one or more name-value pairs. Enclose each property name in quotes. For example, `medObj = vision.Median('Dimension','Column')`

Properties

Unless otherwise indicated, properties are *nontunable*, which means you cannot change their values after calling the object. Objects lock when you call them, and the `release` function unlocks them.

If a property is *tunable*, you can change its value at any time.

For more information on changing property values, see [System Design in MATLAB Using System Objects](#).

SortMethod — Sort method

```
'Quick sort' | 'Insertion sort'
```

Sort method for calculating the median value, specified as `'Quick sort'` or `'Insertion sort'`.

Dimension — Dimension to operate along

```
'Column' (default) | {'All'} | 'Row' | 'Custom'
```

Dimension to operate along, specified as {'All'}, 'Row', 'Column', or 'Custom'. This property applies only when you set the RunningMean property to false.

CustomDimension — Numerical dimension to calculate over

1 (default) | numerical scalar

Numerical dimension to calculate over, specified as a numerical scalar. This property only applies when you set the Dimension property to 'Custom'.

Fixed-Point Properties

RoundingMethod — Rounding method for fixed-point operations

'Floor' (default) | 'Ceiling' | 'Convergent' | 'Nearest' | 'Round' | 'Simplest' | 'Zero'

Rounding method for fixed-point operations, specified as 'Floor', 'Ceiling', 'Convergent', 'Nearest', 'Round', 'Simplest', or 'Zero'.

OverflowAction — Action to take when integer input is out-of-range

'Wrap' (default) | 'Saturate'

Action to take when integer input is out-of-range, specified as 'Wrap' or 'Saturate'.

ProductDataType — Product data type

'Same as input' (default) | 'Custom'

Product data type, specified as 'Same as input' or 'Custom'.

CustomProductDataType — Product word and fraction lengths

numericType(true,32,30) (default) | scaled numericType object

Product word and fraction lengths, specified as a scaled numericType object. This property applies only when you set the AccumulatorDataType property to 'Custom'.

AccumulatorDataType — Data type of accumulator

'Same as product' (default) | 'Same as input' | 'Custom'

Data type of accumulator, specified as 'Same as product', 'Same as input', or 'Custom'.

CustomAccumulatorDataType — Accumulator word and fraction lengths

numericType(true,32,30) (default) | scaled numericType object

Accumulator word and fraction lengths, specified as a scaled numericType object. This property applies only when you set the AccumulatorDataType property to 'Custom'.

Usage

Syntax

```
[value,index] = medObj(input)
```

Description

[value,index] = medObj(input) returns the median value and index of the input.

Input Arguments

input — Input data

vector | matrix | multidimensional array

Input data, specified as a vector, matrix, or multidimensional array.

Output Arguments

value — Median value

same as input

Median value, returned as the same data type as the input

Object Functions

To use an object function, specify the System object as the first input argument. For example, to release system resources of a System object named `obj`, use this syntax:

```
release(obj)
```

Common to All System Objects

<code>step</code>	Run System object algorithm
<code>release</code>	Release resources and allow changes to System object property values and input characteristics
<code>reset</code>	Reset internal states of System object

Examples

Determine Median Value in Grayscale Image

Read a color image.

```
img = imread('peppers.png');
```

Convert the image to grayscale.

```
img = im2single(rgb2gray(img));
```

Find the median.

```
hmed = vision.Median;  
medValue = hmed(img);
```

Extended Capabilities

C/C++ Code Generation

Generate C and C++ code using MATLAB® Coder™.

Usage notes and limitations:

- See “System Objects in MATLAB Code Generation” (MATLAB Coder).

See Also

`vision.Maximum` | `vision.Minimum`

Introduced in R2012a

vision.Minimum

Package: vision

Find minimum values in input or sequence of inputs

Description

Find the minimum values in an input or sequence of inputs.

To track a set of points:

- 1 Create the `vision.Minimum` object and set its properties.
- 2 Call the object with arguments, as if it were a function.

To learn more about how System objects work, see [What Are System Objects?](#)

Creation

Syntax

```
minObj = vision.Minimum  
minObj = vision.Minimum(Name,Value)
```

Description

`minObj = vision.Minimum` returns an object, `minObj`, that computes the value and index of the maximum elements in an input or a sequence of inputs.

`minObj = vision.Minimum(Name,Value)` sets properties using one or more name-value pairs. Enclose each property name in quotes. For example, `minObj = vision.Maximum('RunningMinimum',false)`

Properties

Unless otherwise indicated, properties are *nontunable*, which means you cannot change their values after calling the object. Objects lock when you call them, and the `release` function unlocks them.

If a property is *tunable*, you can change its value at any time.

For more information on changing property values, see [System Design in MATLAB Using System Objects](#).

ValueOutputPort — Output Minimum value

`true` (default) | `false`

Output minimum value, specified as `true` or `false`. Set this property to `true` to output the Minimum value of the input. This property applies when you set the `RunningMinimum` property to `false`.

RunningMinimum — Calculate over single input or multiple inputs

false (default) | true

Calculate over single input or multiple inputs, specified as true or false. When you set this property to true, the object computes the minimum value over a sequence of inputs. When you set this property to false, the object computes the minimum value over the current input.

IndexOutputPort — Output the index of the minimum value

true (default) | false

Output the index of the minimum value, specified as true or false. This property applies only when you set the RunningMinimum property to false.

ResetInputPort — Additional input to enable resetting of running minimum

false (default) | true

Additional input to enable resetting of running minimum, specified as true or false. When you set this property to true, a reset input must be specified to reset the running minimum. This property applies only when you set the RunningMinimum property to true.

ResetCondition — Condition that triggers resetting of running minimum

'Non-zero' (default) | 'Rising edge' | 'Falling edge' | 'Either edge'

Condition that triggers resetting of running minimum, specified as 'Rising edge', 'Falling edge', 'Either edge', or 'Non-zero'. This property applies only when you set the ResetInputPort property to true.

IndexBase — Numbering base for index of minimum value

'One' (default) | 'Zero'

Numbering base for index of minimum value, specified as 'One' or 'Zero'. This property applies only when you set the IndexOutputPort property to true.

Dimension — Dimension to operate along

'Column' (default) | {'All'} | 'Row' | 'Custom'

Dimension to operate along, specified as {'All'}, 'Row', 'Column', or 'Custom'. This property applies only when you set the RunningMinimum property to false.

CustomDimension — Numerical dimension to calculate over

1 (default) | numerical scalar

Numerical dimension to calculate over, specified as a numerical scalar. This property only applies when you set the Dimension property to 'Custom'.

ROIProcessing — Enable region-of-interest processing

false (default) | true

Enable region-of-interest processing, specified as true or false. This property applies when you set the Dimension property to 'All' and the RunningMinimum property to false.

ROIForm — Type of ROI

'Rectangles' (default) | 'Lines' | 'Label matrix' | 'Binary mask'

Type of ROI, specified as 'Rectangles', 'Lines', 'Label matrix', or 'Binary mask'. This property applies only when you set the ROIProcessing property to true.

ROIPortion — ROI or perimeter calculation`'Entire ROI' (default) | 'ROI perimeter'`

ROI or perimeter calculation, specified as 'Entire ROI' or 'ROI perimeter'. This property applies only when you set the ROIForm property to 'Rectangles'.

ROIStatistics — Calculate statistics for each ROI or one for all ROIs`'Individual statistics for each ROI' (default) | 'Single statistic for all ROIs'`

Calculate statistics for each ROI or one for all ROIs, specified as 'Individual statistics for each ROI' or 'Single statistic for all ROIs'. This property applies only when you set the ROIForm property to 'Rectangles', 'Lines', or 'Label matrix'.

ValidityOutputPort — Flag to indicate if any part of ROI is outside input image`false (default) | true`

Flag to indicate if any part of ROI is outside input image, specified as true or false.

This applies when you set the ROIForm property to 'Lines' or 'Rectangles'.

Set this property to true to return the validity of the specified label numbers. This applies when you set the ROIForm property to 'Label matrix'.

Fixed-Point Properties**RoundingMethod — Rounding method for fixed-point operations**`'Floor' (default) | 'Ceiling' | 'Convergent' | 'Nearest' | 'Round' | 'Simplest' | 'Zero'`

Rounding method for fixed-point operations, specified as 'Floor', 'Ceiling', 'Convergent', 'Nearest', 'Round', 'Simplest', or 'Zero'.

OverflowAction — Action to take when integer input is out-of-range`'Wrap' (default) | 'Saturate'`

Action to take when integer input is out-of-range, specified as 'Wrap' or 'Saturate'.

ProductDataType — Product data type`'Same as input' (default) | 'Custom'`

Product data type, specified as 'Same as input' or 'Custom'.

CustomProductDataType — Product word and fraction lengths`numericType(true,32,30) (default) | scaled numericType object`

Product word and fraction lengths, specified as a scaled numericType object. This property applies only when you set the AccumulatorDataType property to 'Custom'.

AccumulatorDataType — Data type of accumulator`'Same as product' (default) | 'Same as input' | 'Custom'`

Data type of accumulator, specified as 'Same as product', 'Same as input', or 'Custom'.

CustomAccumulatorDataType — Accumulator word and fraction lengths`numericType(true,32,30) (default) | scaled numericType object`

Accumulator word and fraction lengths, specified as a scaled numeric type object. This property applies only when you set the `AccumulatorDataType` property to 'Custom'.

Usage

Syntax

```
[value,index] = minObj(input)
index = minObj(input)

[ ___ ] = minObj(I,ROI)
[ ___ ,flag] = minObj(I,ROI)

[ ___ ] = minObj(I,label,labelNumbers)
[ ___ ,flag] = minObj(I,label,labelNumbers)
```

Description

`[value,index] = minObj(input)` returns the minimum value and index of the input.

`index = minObj(input)` returns the one-based index of the minimum value when you set the `IndexOutputPort` property to `true` and the `ValueOutputPort` property to `false`. The `RunningMinimum` property must be set to `false`.

`[___] = minObj(I,ROI)` returns the minimum value in the input image within the given region of interest.

`[___ ,flag] = minObj(I,ROI)` additionally returns a flag to indicate whether the given ROI is within the bounds of the image.

`[___] = minObj(I,label,labelNumbers)` returns the minimum of the input image for a region the labels specified in the `labelNumbers` vector. The regions are defined and labeled in the `label` matrix.

`[___ ,flag] = minObj(I,label,labelNumbers)` additionally returns a flag to indicate whether the input label numbers are valid.

Input Arguments

input — Input data

vector | matrix | multidimensional array

Input data, specified as a vector, matrix, or multidimensional array.

ROI — Region of interest

four-element vector

Region of interest, specified as a four-element vector, `[x y width height]`. This option is available when you set the `ROIProcessing` property to `true` and the `ROIForm` property to 'Lines', 'Rectangles', or 'Binary Mask'.

label — Label numbers

matrix

Label numbers, specified as a matrix. This option is available when you set the `ROIProcessing` property to `true` and the `ROIForm` property to `'Label matrix'`.

LabelNumbers — Label numbers

vector

Label numbers, specified as a vector. This option is available when you set the `ROIProcessing` property to `true` and the `ROIForm` property to `'Label matrix'`.

Output Arguments**value — Minimum value**

same as input

Minimum value, returned as the same data type as the input

index — Index to minimum value

one-based index

Index to minimum value, returned as a one-based index.

flag — Flag for valid data

`true` | `false`

Flag for valid data, returned as `true` or `false`.

Object Functions

To use an object function, specify the System object as the first input argument. For example, to release system resources of a System object named `obj`, use this syntax:

```
release(obj)
```

Common to All System Objects

`step` Run System object algorithm

`release` Release resources and allow changes to System object property values and input characteristics

`reset` Reset internal states of System object

Examples**Find Index to Minimum Value in Grayscale Image**

Read a color image.

```
img = imread('peppers.png');
```

Convert the image to grayscale.

```
img = im2single(im2gray(img));
```

Find the maximum.

```
hMin = vision.Minimum
hMin =
  vision.Minimum with properties:
    ValueOutputPort: true
    RunningMinimum: false
    IndexOutputPort: true
    Dimension: 'All'
    ROIProcessing: false

  Show all properties

[m, ind] = hMin(img);
```

Extended Capabilities

C/C++ Code Generation

Generate C and C++ code using MATLAB® Coder™.

Usage notes and limitations:

- See “System Objects in MATLAB Code Generation” (MATLAB Coder).

See Also

[vision.Mean](#) | [vision.Maximum](#)

Introduced in R2012a

vision.VideoFileReader

Package: vision

Read video frames and audio samples from video file

Description

The `VideoFileReader` object reads video frames, images, and audio samples from a video file. The object can also read image files.

Platforms	File Formats
All Platforms	AVI, including uncompressed, indexed, grayscale, and Motion JPEG-encoded video (.avi) Motion JPEG 2000 (.mj2)
All Windows	MPEG-1 (.mpg) Windows Media Video (.wmv, .asf, .asx) Any format supported by Microsoft DirectShow®
Windows 7 or later	MPEG-4, including H.264 encoded video (.mp4, .m4v) Apple QuickTime Movie (.mov) Any format supported by Microsoft Media Foundation
Macintosh	Most formats supported by QuickTime Player, including: MPEG-1 (.mpg) MPEG-4, including H.264 encoded video (.mp4, .m4v) Apple QuickTime Movie (.mov) 3GPP 3GPP2 AVCHD DV Note: For OS X Yosemite (Version 10.10) and later, MPEG-4/H.264 files written using <code>VideoWriter</code> , play correctly, but display an inexact frame rate.
Linux	Any format supported by your installed plug-ins for GStreamer 1.0 or higher, as listed on https://gstreamer.freedesktop.org/documentation/plugins_doc.html , including Ogg Theora (.ogg).

To read a file:

- 1 Create the `vision.VideoFileReader` object and set its properties.
- 2 Call the object with arguments, as if it were a function.

To learn more about how System objects work, see [What Are System Objects?](#)

Creation

Syntax

```
videoFReader = vision.VideoFileReader(FileName)
videoFReader = vision.VideoFileReader( ___,Name,Value)
```

Description

`videoFReader = vision.VideoFileReader(FileName)` returns a video file reader System object, `videoFReader`, that sequentially reads video frames or audio samples from an input file, `FileName`.

`videoFReader = vision.VideoFileReader(___,Name,Value)` additionally sets properties using one or more name-value pairs. Enclose each property name in quotes. For example, `videoFReader = vision.VideoFileReader('PlayCount',1)`

Properties

Unless otherwise indicated, properties are *nontunable*, which means you cannot change their values after calling the object. Objects lock when you call them, and the `release` function unlocks them.

If a property is *tunable*, you can change its value at any time.

For more information on changing property values, see System Design in MATLAB Using System Objects.

Filename — File name

`vipmen.avi` (default) | character vector

File name, specified as a character vector. The full path for the file needs to be specified only if the file is not on the MATLAB path.

PlayCount — Number of times to play file

1 (default) | positive integer | `inf`

Number of times to play file, specified as a positive integer.

AudioOutputPort — Output audio data

`false` (default) | `true`

Output audio data, specified as `true` or `false`. Use this property to control the audio output only when the input file contains audio and video streams.

ImageColorSpace — Image format

RGB (default) | YCbCr 4:2:2 | intensity video

Image format, specified as RGB, YCbCr 4:2:2, or intensity video frames when the input file contains video.

VideoOutputDataType — Output video data type

`single` (default)

Output video data type, specified as one of the data types listed and `inherit`. This property applies when the input file contains video.

Data Types: `double` | `int8` | `int16` | `int32` | `uint8` | `uint16`

AudioOutputDataType — Output audio samples data type

`int16` (default)

Output audio samples data type, specified as one of the data types listed and `inherit`. This property applies when the input file contains audio.

Data Types: `double` | `single` | `int16` | `uint8`

Usage

Syntax

```
I = videoFReader()  
[Y,Cb,Cr] = videoFReader()  
[ __ ,audio] = videoFReader()  
[ __ ,EOF] = videoFReader()
```

Description

`I = videoFReader()` returns the next video frame.

`[Y,Cb,Cr] = videoFReader()` returns the next frame of YCbCr 4:2:2 format video in the color components Y, Cb, and Cr. This syntax requires that you set the 'ImageColorSpace' property to 'YCbCr 4:2:2'

`[__ ,audio] = videoFReader()` also returns one frame of audio samples, `audio`. This syntax requires that you set the `AudioOutputPort` property to `true`.

`[__ ,EOF] = videoFReader()` also returns the end-of-file indicator, `EOF`. The object sets `EOF` to `true` each time the output contains the last audio sample and/or video frame.

Output Arguments

I — Video frame

`truecolor` | 2-D grayscale image

Video frame, returned as a `truecolor` or 2-D grayscale image.

Y, Cb, Cr — YCbCr color channels

numeric matrices

YCbCr color channels of a YCbCr 4:2:2 format image, returned as numeric matrices.

audio — One frame of audio samples

`.wav` | `.mp3` | `.mp3` | `.mp4` | `.ogg` | `.flac` | `.au` | `.aiff` | `.aif` | `.aifc`

One frame of audio samples, returned in one of the following formats.

Platform	Supported File Name Extensions
All Platforms	AVI (.avi)
Windows	<p>Image: .jpg, .bmp</p> <p>Video: MPEG (.mpeg) MPEG-2 (.mp2) MPEG-1 .mpg MPEG-4, including H.264 encoded video (.mp4, .m4v) Motion JPEG 2000 (.mj2) Windows Media Video (.wmv, .asf, .asx, .asx) and any format supported by Microsoft DirectShow® 9.0 or higher.</p> <p>Audio: WAVE (.wav) Windows Media Audio File (.wma) Audio Interchange File Format (.aif, .aiff) Compressed Audio Interchange File Format(.aifc), MP3 (.mp3) Sun Audio (.au) Apple (.snd)</p>
Macintosh	<p>Video: .avi Motion JPEG 2000 (.mj2) MPEG-4, including H.264 encoded video (.mp4, .m4v) Apple QuickTime Movie (.mov) and any format supported by QuickTime as listed on http://support.apple.com/kb/HT3775.</p> <p>Audio: Uncompressed .avi</p>
Linux	<p>Motion JPEG 2000 (.mj2) Any format supported by your installed plug-ins for GStreamer 0.1 or higher, as listed on https://gstreamer.freedesktop.org/documentation/plugins_doc.html?gi-language=c, including Ogg Theora (.ogg).</p>

Windows XP and Windows 7 x64 platform ships with a limited set of 64-bit video and audio codecs. If a compressed multimedia file fails to play, try saving the multimedia file to a supported file format listed in the table above.

If you use Windows, use Windows Media player Version 11 or later.

Note MJ2 files with bit depth higher than 8-bits are not supported by `vision.VideoFileReader`. Use `VideoReader` and `VideoWriter` for higher bit depths.

Reading audio from compressed MP4 files with video and audio is not supported by `vision.VideoFileReader`.

EOF — End-of-file

true | false

End-of-file indicator, returned as `true` or `false`.

Object Functions

To use an object function, specify the System object as the first input argument. For example, to release system resources of a System object named `obj`, use this syntax:

```
release(obj)
```

Specific to vision.VideoFileReader

`info` Information about specified video file
`isDone` End-of-file status (logical)

Common to All System Objects

`step` Run System object algorithm
`release` Release resources and allow changes to System object property values and input characteristics
`reset` Reset internal states of System object

Examples

Read and Play a Video File

Load the video using a video reader object.

```
videoFReader = vision.VideoFileReader('ecolicells.avi');
```

Create a video player object to play the video file.

```
videoPlayer = vision.VideoPlayer;
```

Use a while loop to read and play the video frames. Pause for 0.1 seconds after displaying each frame.

```
while ~isDone(videoFReader)
    videoFrame = videoFReader();
    videoPlayer(videoFrame);
    pause(0.1)
end
```

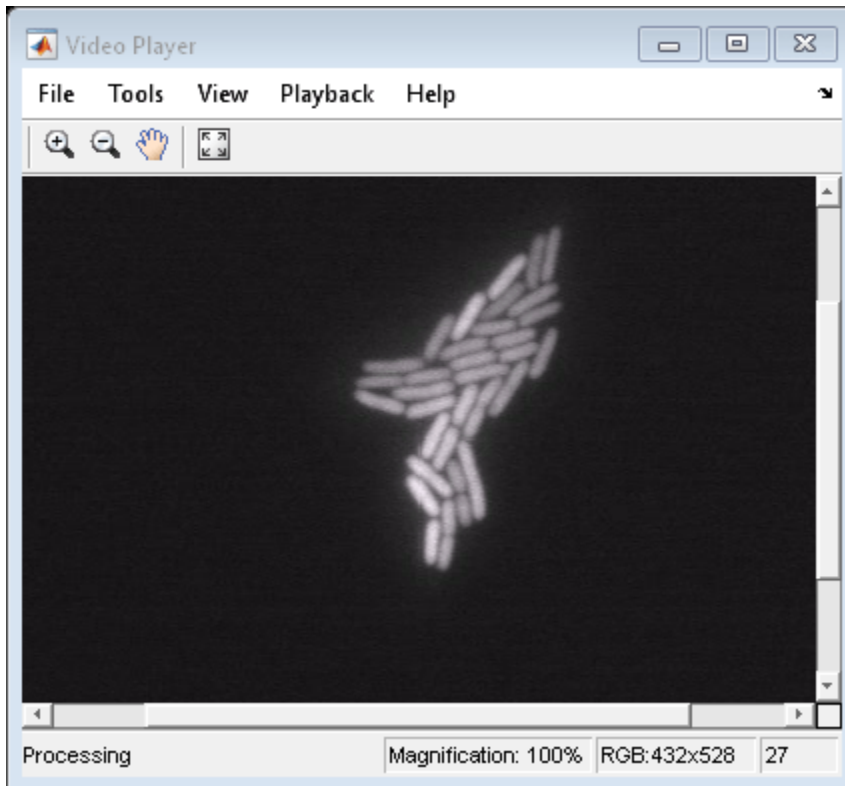

Release the objects.

```
release(videoPlayer);  
release(videoFReader);
```

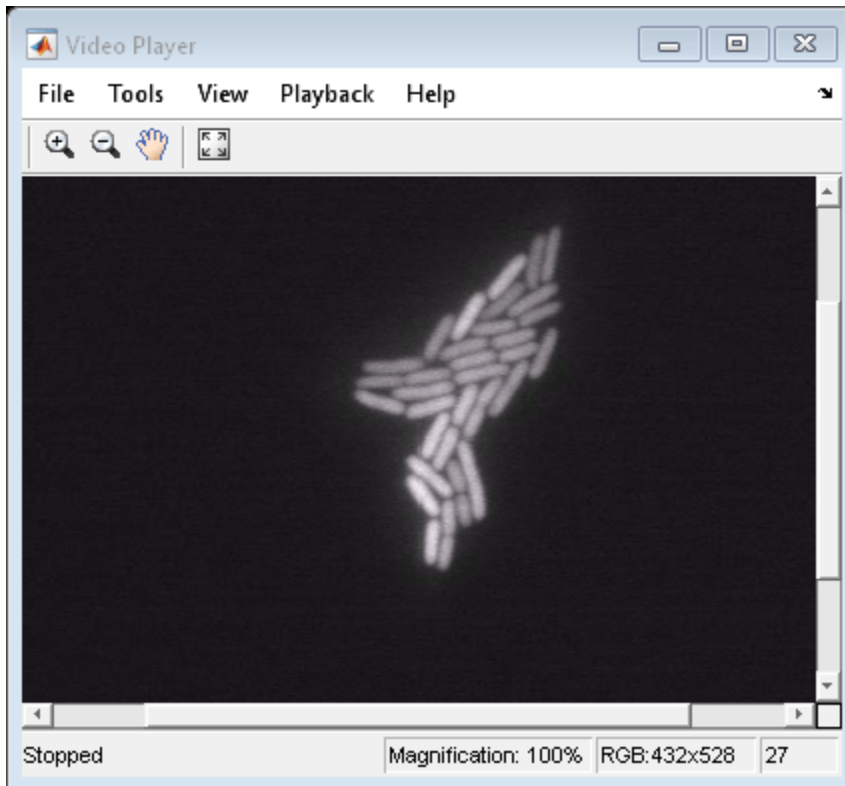

Tips

- Video Reading Performance on Windows Systems: To achieve better video reader performance on Windows for MP4 and MOV files, MATLAB uses the system's graphics hardware for decoding. However, in some cases using the graphics card for decoding can result in poorer performance depending on the specific graphics hardware on the system. If you notice slower video reader performance on your system, turn off the hardware acceleration by typing:

```
matlab.video.read.UseHardwareAcceleration('off')
```

Hardware acceleration can be reenabled by typing:

```
matlab.video.read.UseHardwareAcceleration('on')
```

Extended Capabilities

C/C++ Code Generation

Generate C and C++ code using MATLAB® Coder™.

Usage notes and limitations:

- Generated code for this function uses a precompiled platform-specific shared library.
- See “System Objects in MATLAB Code Generation” (MATLAB Coder).

See Also

[vision.VideoFileWriter](#) | [VideoWriter](#) | [VideoReader](#) | [vision.VideoPlayer](#) | **Video Viewer**

Topics

[“Video Display in a Custom User Interface”](#)

Introduced in R2012a

vision.VideoFileWriter

Package: vision

Write video frames and audio samples to video file

Description

The `VideoFileWriter` object writes video frames and audio samples to a video file. The video and audio can be compressed. The available compression types depend on the encoders installed on the platform.

Note This block supports code generation for platforms that have file I/O available. You cannot use this block with Simulink Desktop Real-Time software, because that product does not support file I/O.

This object performs best on platforms with Version 11 or later of Windows Media Player software. This object supports only uncompressed RGB24 AVI files on Linux and Mac platforms.

The generated code for this object relies on prebuilt library files. You can run this code outside the MATLAB environment, or redeploy it, but be sure to account for these extra library files when doing so. The `packNGo` function creates a single zip file containing all of the pieces required to run or rebuild this code. See `packNGo` for more information.

To run an executable file that was generated from an object, you may need to add precompiled shared library files to your system path. See “MATLAB Coder” and “Simulink Shared Library Dependencies” for details.

Note Starting in R2016b, instead of using the `step` method to perform the operation defined by the System object, you can call the object with arguments, as if it were a function. For example, `y = step(obj, x)` and `y = obj(x)` perform equivalent operations.

Creation

Syntax

```
videoFWriter = vision.VideoFileWriter
videoFWriter = vision.VideoFileWriter(FileName)
videoFWriter = vision.VideoFileWriter( ___, Name, Value)
```

Description

`videoFWriter = vision.VideoFileWriter` returns a video file writer System object, `videoFWriter`. It writes video frames to an uncompressed 'output.avi' video file. Every call to the `step` method writes a video frame.

`videoFWriter = vision.VideoFileWriter(FileName)` returns a video file writer object, `videoFWriter` that writes video to a file, `FileName`. The file type can be `.avi`, `.mj2`, `.mp4`, and `.m4v` specified by the `FileFormat` property.

`videoFWriter = vision.VideoFileWriter(____, Name, Value)` configures the video file writer properties, specified as one or more name-value pair arguments. Unspecified properties have default values.

`Name` is a property name and `Value` is the corresponding value. `Name` must appear inside single quotes (`' '`). You can specify several name-value pair arguments in any order as `Name1, Value1, ..., NameN, ValueN`.

Example: `videoFWriter = vision.VideoFileWriter('myFile.avi', 'FrameRate', ... videoFReader.info.VideoFrameRate);`

Properties

Filename — Video output file name

`output.avi` (default) | character vector

Video output file name, specified as a character vector. The file extension you give for `Filename` must match the `FileFormat`.

FileFormat — Output file format

'AVI' (default) | 'MJ2000' | 'MPEG4'

Output file format, specified as one of the supported file formats shown in the table.

File Format	Description	File Extension	Supported Platform
'AVI'	Audio-Video Interleave file	.avi	All platforms
'MJ2000'	Motion JPEG 2000 file	.mj2	All platforms
'MPEG4'	MPEG-4/H.264 Video	.mp4 , .m4v	Windows and Mac

AudioInputPort — Write audio data

`false` (default) | `true`

Write audio data, specified as `false` or `true`. Use this property to control whether the object writes audio samples to the video file. Set this value to `true` to write audio data. To write audio and video to a file, you must use the `.avi` format.

FrameRate — Video frame rate

30 (default) | positive numeric scalar

Video frame rate in frames per second, specified as a positive numeric scalar. For videos which also contain audio data, the rate of the audio data will be determined as the rate of the video multiplied by the number of audio samples passed in. For example, if you use a frame rate of 30, and pass 1470 audio samples, the object sets the audio sample to 44100, ($1470 \times 30 = 44100$).

AudioCompressor — Audio compression encoder

`None` (uncompressed) (default) | system compressors

Specify the type of compression algorithm to implement for audio data. This compression reduces the size of the video file. Choose `None` (uncompressed) to save uncompressed audio data to the video file. The other options reflect the available audio compression algorithms installed on your system. This property applies only when writing AVI files on Windows platforms.

VideoCompressor — Video compression encoder

None (uncompressed) (default) | system compressors

Specify the type of compression algorithm to use to compress the video data. This compression reduces the size of the video file. Choose `None (uncompressed)` to save uncompressed video data to the video file. The `VideoCompressor` property can also be set to one of the compressors available on your system. To obtain a list of available video compressors, you can use tab completion. Follow these steps:

- 1 Instantiate the object:

```
y = vision.VideoFileWriter
```

- 2 To launch the tab completion functionality, type the following up to the open quote.

```
y.VideoCompressor='
```

A list of compressors available on your system will appear after you press the Tab key. For example:

```
>>
>>
>>
>>
>>
>> y.VideoCompressor='
```

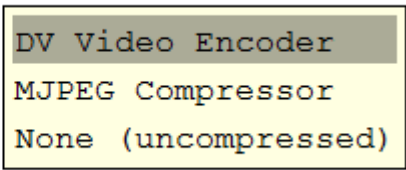

This property applies only when writing AVI files on Windows platforms.

AudioDataType — Uncompressed audio data type

WAV (default)

Specify the compressed output audio data type. This property only applies when you write uncompressed WAV files.

FileColorSpace — Color space for output file

RGB (default) | YCbCr 4:2:2

Color space for output AVI file, specified as RGB or YCbCr 4:2:2. This property applies when you set the `FileFormat` property to AVI and only on Windows platforms.

Quality — Control size of output video file

75 (default) | integer

Control size of output video file, specified as an integer in the range [0,100]. Increase this value for greater video quality. However, doing so increases the file size. Decrease the value to lower video quality with a smaller file size.

The `Quality` property only applies when you are writing MPEG4 video files (on Windows or Mac) or when you are writing MJPEG-AVI video only files on a Mac or Linux.

CompressionFactor — Target ratio between number of bytes in input image and compressed image

10 (default) | integer

Target ratio between number of bytes in input image and compressed image, specified as an integer greater than 1. The `CompressionFactor` indicates the target ratio between the number of bytes in the input image and the compressed image. The data is compressed as much as possible, up to the specified target. This property applies only when writing Lossy MJ2000 files.

Usage

Syntax

```
Filename = videoFWriter(videoFrame)
Filename = videoFWriter(videoFrame, audio)
Filename = videoFWriter(videoFrame, Y, Cb, Cr, audio)
```

Description

`Filename = videoFWriter(videoFrame)` writes one frame of video, `videoFrame`, to the output file. The input video can be an *M*-by-*N*-by-3 truecolor RGB video frame, or an *M*-by-*N* grayscale video frame..

`Filename = videoFWriter(videoFrame, audio)` writes one frame of the input video, `videoFrame`, and one frame of audio samples, `audio`, to the output file. This applies when you set the `AudioInputPort` property to `true`.

`Filename = videoFWriter(videoFrame, Y, Cb, Cr, audio)` writes one frame of YCbCr 4:2:2 video, and one frame of audio samples, `audio`, to the output file. This applies when you set the `AudioInputPort` to `true` and the `FileColorSpace` property to 'YCbCr 4:2:2'. The width of Cb and Cr color components must be half of the width of Y.

Input Arguments

videoFrame — Video frame

truecolor | 2-D grayscale image

Video frame, returned as a truecolor or 2-D grayscale image.

Y, Cb, Cr — YCbCr color format

'YCbCr 4:2:2'

YCbCr color format, returned in the YCbCr 4:2:2 format.

audio — One frame of audio samples

.wav | .mp3 | .mp3 | .mp4 | .ogg | .flac | .au | .aiff | .aif | .aifc

One frame of audio samples, returned in one of the following formats.

Platform	Supported File Name Extensions
All Platforms	AVI (.avi)
Windows	Image: .jpg, .bmp

Platform	Supported File Name Extensions
	<p>Video: MPEG (.mpeg) MPEG-2 (.mp2) MPEG-1 .mpg MPEG-4, including H.264 encoded video (.mp4, .m4v) Motion JPEG 2000 (.mj2) Windows Media Video (.wmv, .asf, .asx, .asx) and any format supported by Microsoft DirectShow® 9.0 or higher.</p> <p>Audio: WAVE (.wav) Windows Media Audio File (.wma) Audio Interchange File Format (.aif, .aiff) Compressed Audio Interchange File Format(.aifc), MP3 (.mp3) Sun Audio (.au) Apple (.snd)</p>
Macintosh	<p>Video: .avi Motion JPEG 2000 (.mj2) MPEG-4, including H.264 encoded video (.mp4, .m4v) Apple QuickTime Movie (.mov) and any format supported by QuickTime as listed on http://support.apple.com/kb/HT3775.</p> <p>Audio: Uncompressed .avi</p>
Linux	Motion JPEG 2000 (.mj2) Any format supported by your installed plug-ins for GStreamer 0.1 or higher, as listed on http://gstreamer.freedesktop.org/documentation/plugins.html , including Ogg Theora (.ogg).

Windows XP and Windows 7 x64 platform ships with a limited set of 64-bit video and audio codecs. If a compressed multimedia file fails to play, try saving the multimedia file to a supported file format listed in the table above.

If you use Windows, use Windows Media player Version 11 or later.

Note MJ2 files with bit depth higher than 8-bits is not supported by `vision.VideoFileReader`. Use `VideoReader` and `VideoWriter` for higher bit depths.

Reading audio from compressed MP4 files with video and audio is not supported by `vision.VideoFileReader`.

Output Arguments

Filename — Video output file name

' .avi ' (default) | ' .mj2 ' | ' .mp4 ' | ' .m4v '

Video output file name, specified as ' .avi ', ' .mj2 ', ' .mp4 ', and ' .m4v '. The file extension you give for `Filename` must match the `FileFormat`.

Object Functions

To use an object function, specify the System object as the first input argument. For example, to release system resources of a System object named `obj`, use this syntax:

```
release(obj)
```

Specific to vision.VideoFileWriter

`info` Information about specified video file
`isDone` End-of-file status (logical)

Common to All System Objects

`step` Run System object algorithm
`release` Release resources and allow changes to System object property values and input characteristics
`reset` Reset internal states of System object

Examples

Write a Video to an AVI File

Load a video file and write the file to a writer object.

```
videoFReader = vision.VideoFileReader('viplannedeparture.mp4');
videoFWriter = vision.VideoFileWriter('myFile.avi', ...
    'FrameRate', videoFReader.info.VideoFrameRate);
```

Write the first 50 frames from original file into a newly created `myFile.avi` file.

```
for i=1:50
    videoFrame = videoFReader();
    videoFWriter(videoFrame);
end
```

Close the input and output files.

```
release(videoFReader);
release(videoFWriter);
```

Extended Capabilities

C/C++ Code Generation

Generate C and C++ code using MATLAB® Coder™.

Usage notes and limitations:

- Generated code for this function uses a precompiled platform-specific shared library.
- See “System Objects in MATLAB Code Generation” (MATLAB Coder).

See Also

`vision.VideoFileReader` | `VideoWriter` | `VideoReader` | `vision.VideoPlayer`

Introduced in R2012a

ocrText

Object for storing OCR results

Description

`ocrText` object contains recognized text and metadata collected during optical character recognition (OCR). You can access the information contained in the object with the `ocrText` properties. You can also locate text that matches a specific pattern with the `locateText` function.

Creation

Create an `ocrText` object using the `ocr` function.

Properties

Text — Text recognized by OCR

array of characters

Text recognized by OCR, specified as an array of characters. The text includes white space and new line characters.

CharacterBoundingBoxes — Bounding box locations

M-by-4 matrix

Bounding box locations, stored as an *M*-by-4 matrix. Each row of the matrix contains a four-element vector, $[x \ y \ width \ height]$. The $[x \ y]$ elements correspond to the upper-left corner of the bounding box. The $[width \ height]$ elements correspond to the size of the rectangular region in pixels. The bounding boxes enclose text found in an image using the `ocr` function. Bounding boxes width and height that correspond to new line characters are set to zero. Character modifiers found in languages, such as Hindi, Tamil, and Bangalese, are also contained in a zero width and height bounding box.

CharacterConfidences — Character recognition confidence

array

Character recognition confidence, specified as an array. The confidence values are in the range $[0, 1]$. A confidence value, set by the `ocr` function, should be interpreted as a probability. The `ocr` function sets confidence values for spaces between words and sets new line characters to NaN. Spaces and new line characters are not explicitly recognized during OCR. You can use the confidence values to identify the location of misclassified text within the image by eliminating characters with low confidence.

Words — Recognized words

cell array

Recognized words, specified as a cell array.

WordBoundingBoxes — Bounding box location and size

M-by-4 matrix

Bounding box location and size, stored as an M -by-4 matrix. Each row of the matrix contains a four-element vector, $[x \ y \ width \ height]$, that specifies the upper left corner and size of a rectangular region in pixels.

WordConfidences — Recognition confidence

array

Recognition confidence, specified as an array. The confidence values are in the range $[0, 1]$. A confidence value, set by the `ocr` function, should be interpreted as a probability. The `ocr` function sets confidence values for spaces between words and sets new line characters to `NaN`. Spaces and new line characters are not explicitly recognized during OCR. You can use the confidence values to identify the location of misclassified text within the image by eliminating words with low confidence.

Object Functions

`locateText` Locate text pattern

Examples

Find and Highlight Text in an Image

```
businessCard = imread('businessCard.png');  
ocrResults = ocr(businessCard);  
bboxes = locateText(ocrResults, 'MathWorks', 'IgnoreCase', true);  
Iocr = insertShape(businessCard, 'FilledRectangle', bboxes);  
figure; imshow(Iocr);
```

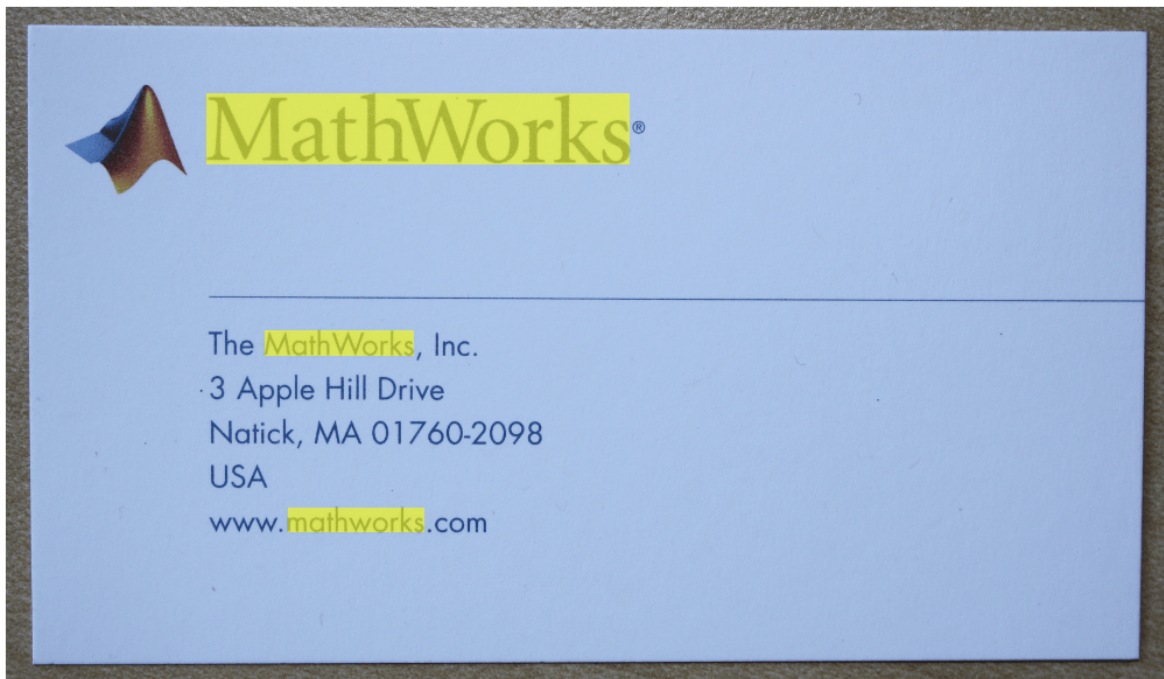

Find Text Using Regular Expressions

```
businessCard = imread('businessCard.png');  
ocrResults = ocr(businessCard);  
bboxes = locateText(ocrResults, 'www.*com', 'UseRegexp', true);  
img = insertShape(businessCard, 'FilledRectangle', bboxes);  
figure; imshow(img);
```



Extended Capabilities

C/C++ Code Generation

Generate C and C++ code using MATLAB® Coder™.

Usage notes and limitations:

- Use in a MATLAB Function block is not supported.
- The Words property cannot be accessed in code generation. Use the Text property in place of the Words property to access the OCR results.

See Also

OCR Trainer | **ocr** | **insertShape** | **regexp** | **strfind**

Introduced in R2014a

locateText

Locate text pattern

Syntax

```
bboxes = locateText(ocrText,pattern)
bboxes = locateText(ocrText,pattern,Name,Value)
```

Description

`bboxes = locateText(ocrText,pattern)` returns the location and size of bounding boxes stored in the `ocrText` object. The `locateText` function returns only the locations of bounding boxes which correspond to text within an image that exactly match the input `pattern`.

`bboxes = locateText(ocrText,pattern,Name,Value)` uses additional options specified by one or more name-value pair arguments.

Examples

Find and Highlight Text in an Image

```
businessCard = imread('businessCard.png');
ocrResults = ocr(businessCard);
bboxes = locateText(ocrResults, 'MathWorks', 'IgnoreCase', true);
Iocr = insertShape(businessCard, 'FilledRectangle', bboxes);
figure; imshow(Iocr);
```

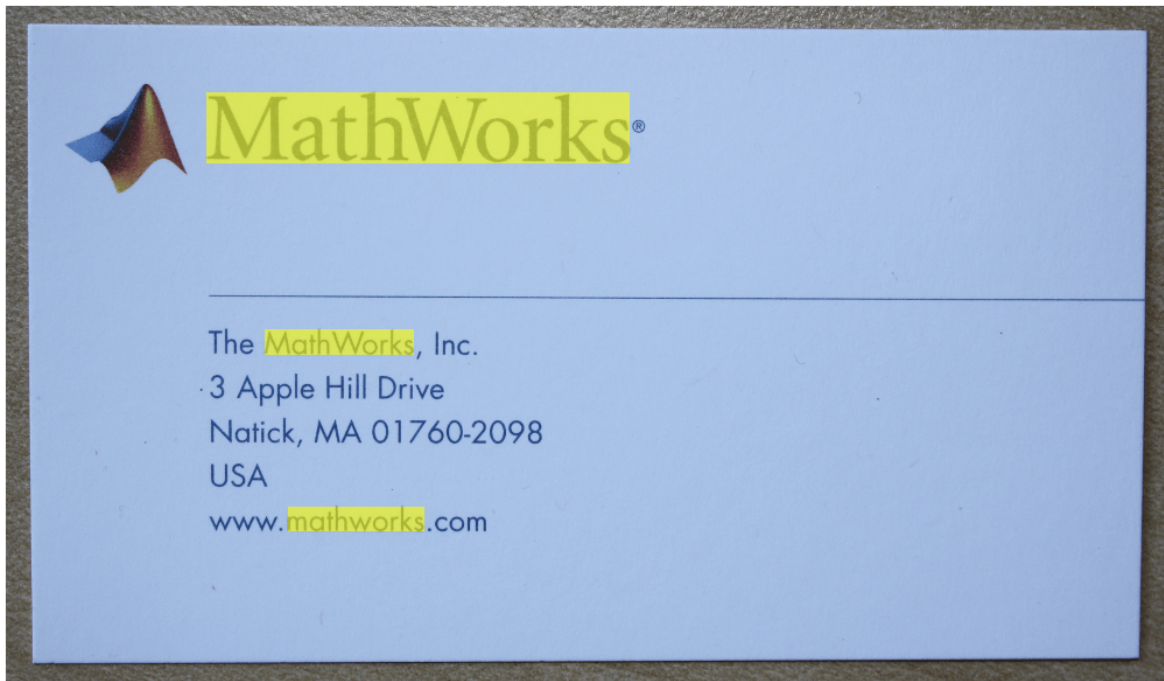

Find Text Using Regular Expressions

```
businessCard = imread('businessCard.png');  
ocrResults = ocr(businessCard);  
bboxes = locateText(ocrResults, 'www.*com', 'UseRegexp', true);  
img = insertShape(businessCard, 'FilledRectangle', bboxes);  
figure; imshow(img);
```

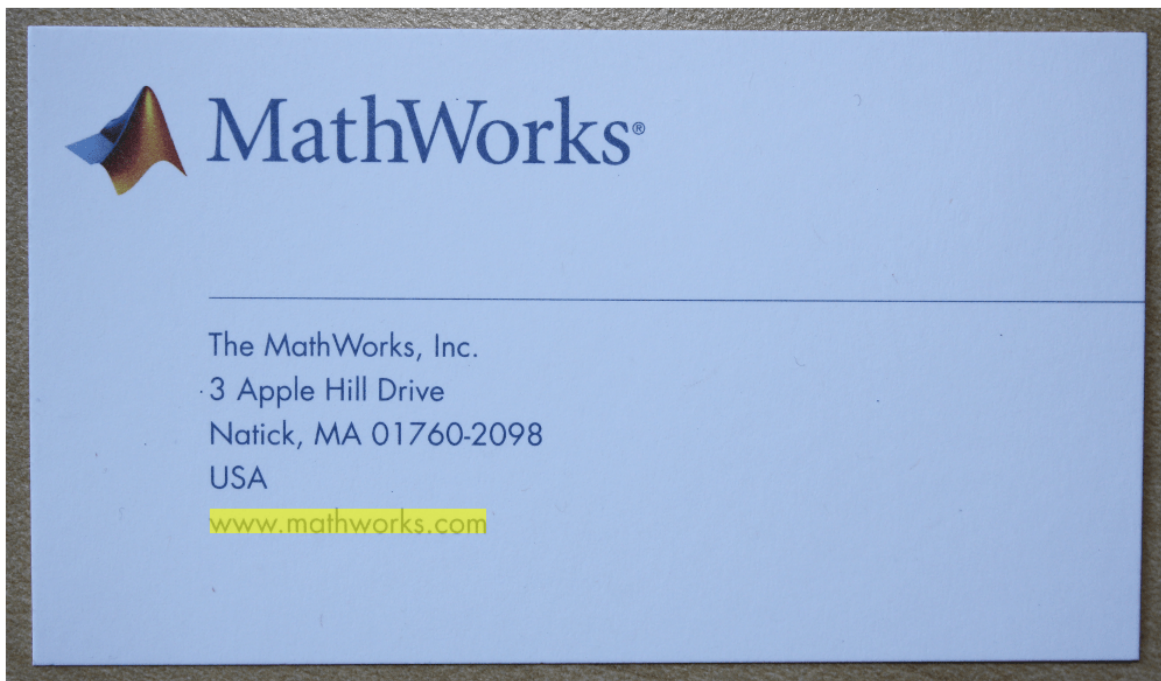

Input Arguments

ocrText — Object containing OCR results

ocrText object

Recognized text and metrics, returned as an `ocrText` object. The object contains the recognized text, the location of the recognized text within the input image, and the metrics indicating the confidence of the results. The confidence values range between 0 and 100 and represent a percent probability. When you specify an M -by-4 `roi`, the function returns `ocrText` as an M -by-1 array of `ocrText` objects. Confidence values range between 0 and 1. Interpret the confidence values as probabilities.

pattern — OCR character vector pattern

single character vector | cell array of character vectors | string scalar | string array

OCR character vector pattern, specified as a single character vector, string scalar, cell array of character vectors, or a string array. The method returns only the locations of bounding boxes which correspond to text within an image that exactly match the input `pattern`.

Name-Value Pair Arguments

Specify optional comma-separated pairs of `Name`, `Value` arguments. `Name` is the argument name and `Value` is the corresponding value. `Name` must appear inside quotes. You can specify several name and value pair arguments in any order as `Name1`, `Value1`, ..., `NameN`, `ValueN`.

Example: 'IgnoreCase', true specifies case-insensitive text locations

UseRegexp — Regular expression`false` (default) | logical scalar

Regular expression, specified as a logical scalar. When you set this property to `true`, the method treats the pattern as a regular expression. For more information about regular expressions, see `regexp`.

IgnoreCase — Case sensitivity`false` (default) | logical scalar

Case sensitivity, specified as a logical scalar. When you set this property to `true`, the method performs case-insensitive text location.

Output Arguments**bboxes — Text bounding boxes**method | *M*-by-4 matrix

Text bounding boxes, returned as an *M*-by-4 matrix. Each row of the matrix contains a four-element vector, [*x y width height*]. The [*x y*] elements correspond to the upper-left corner of the bounding box. The [*width height*] elements correspond to the size of the rectangular region in pixels. The bounding boxes enclose text found in an image using the `ocr` function. The `ocr` function stores OCR results in the `ocrText` object.

See Also**Introduced in R2014a**

pointCloud

Object for storing 3-D point cloud

Description

The `pointCloud` object creates point cloud data from a set of points in 3-D coordinate system. The points generally represent the x , y , and z geometric coordinates of a sample surface or an environment. Each point can also be represented with additional information, such as RGB color. The point cloud data is stored as an object with the properties listed in “Properties” on page 2-603. Use “Object Functions” on page 2-604 to retrieve, select, and remove desired points from the point cloud data.

Creation

Syntax

```
ptCloud = pointCloud(xyzPoints)
ptCloud = pointCloud(xyzPoints,Name,Value)
```

Description

`ptCloud = pointCloud(xyzPoints)` returns a point cloud object with coordinates specified by `xyzPoints`.

`ptCloud = pointCloud(xyzPoints,Name,Value)` creates a `pointCloud` object with properties specified as one or more `Name,Value` pair arguments. For example, `pointCloud(xyzPoints,'Color',[0 0 0])` sets the `Color` property of the point `xyzPoints` as `[0 0 0]`. Enclose each property name in quotes. Any unspecified properties have default values.

Input Arguments

xyzPoints — 3-D coordinate points

M-by-3 list of points | *M*-by-*N*-by-3 array for organized point cloud

3-D coordinate points, specified as an *M*-by-3 list of points or an *M*-by-*N*-by-3 array for an organized point cloud. The 3-D coordinate points specify the x , y , and z positions of a point in the 3-D coordinate space. The first two dimensions of an organized point cloud correspond to the scanning order from sensors such as RGBD or lidar. This argument sets the `Location` property.

Data Types: `single` | `double`

Output Arguments

ptCloud — Point cloud

`pointCloud` object

Point cloud, returned as a `pointCloud` object with the properties listed in “Properties” on page 2-603.

Properties

Location — Position of the points in 3-D coordinate space

M-by-3 array | *M*-by-*N*-by-3 array

This property is read-only.

Position of the points in 3-D coordinate space, specified as an *M*-by-3 or *M*-by-*N*-by-3 array. Each entry specifies the *x*, *y*, and *z* coordinates of a point in the 3-D coordinate space. You cannot set this property as a name-value pair. Use the `xyzPoints` input argument.

- For unorganized point clouds, `Location` must be specified as an *M*-by-3 array, where *M* is the total number of points in the point cloud.
- For organized point clouds, `Location` must be specified as an *M*-by-*N*-by-3 array. The three channels represent the *x*, *y*, and *z* coordinates of the points. Points obtained from a projective camera, such as Kinect or a lidar sensor, are stored as an organized point cloud.

Data Types: `single` | `double`

Color — Point cloud color

[] (default) | *M*-by-3 array | *M*-by-*N*-by-3 array

Point cloud color, specified as an *M*-by-3 or *M*-by-*N*-by-3 array. Use this property to set the color of points in point cloud. Each entry specifies the RGB color of a point in the point cloud data. Therefore, you can specify the same color for all points or a different color for each point.

- The specified RGB values must lie within the range [0, 1], when you specify the data type for `Color` as `single` or `double`.
- The specified RGB values must lie within the range [0, 255], when you specify the data type for `Color` as `uint8`.

Coordinates	Valid assignment of Color	
<i>M</i> -by-3 array	<i>M</i> -by-3 array containing RGB values for each point	
<i>M</i> -by- <i>N</i> -by-3 array	<i>M</i> -by- <i>N</i> -by-3 array containing RGB values for each point	

Data Types: `uint8`

Normal — Surface normals

[] (default) | *M*-by-3 array | *M*-by-*N*-by-3 array

Surface normals, specified as a M -by-3 or M -by- N -by-3 array. Use this property to specify the normal vector with respect to each point in the point cloud. Each entry in the surface normals specifies the x , y , and z component of a normal vector.

Coordinates	Surface Normals
M -by-3 array	M -by-3 array, where each row contains a corresponding normal vector.
M -by- N -by-3 array	M -by- N -by-3 array containing a 1-by-1-by-3 normal vector for each point.

Data Types: `single` | `double`

Intensity — Grayscale intensities

[] (default) | M -by-1 vector | M -by- N matrix

Grayscale intensities at each point, specified as a M -by-1 vector or M -by- N matrix. The function maps each intensity value to a color value in the current colormap.

Coordinates	Intensity
M -by-3 array	M -by-1 vector, where each row contains a corresponding intensity value.
M -by- N -by-3 array	M -by- N matrix containing intensity value for each point.

Data Types: `single` | `double` | `uint8`

Count — Number of points

positive integer

This property is read-only.

Number of points in the point cloud, stored as a positive integer.

XLimits — Range of x coordinates

1-by-2 vector

This property is read-only.

Range of coordinates along x -axis, stored as a 1-by-2 vector.

YLimits — Range of y coordinates

1-by-2 vector

This property is read-only.

Range of coordinates along y -axis, stored as a 1-by-2 vector.

ZLimits — Range of z coordinates

1-by-2 vector

This property is read-only.

Range of coordinates along z -axis, stored as a 1-by-2 vector.

Object Functions

`findNearestNeighbors` Find nearest neighbors of a point in point cloud

findNeighborsInRadius	Find neighbors within a radius of a point in the point cloud
findPointsInROI	Find points within a region of interest in the point cloud
removeInvalidPoints	Remove invalid points from point cloud
select	Select points in point cloud
copy	Copy array of handle objects

Examples

Create a Point Cloud Object and Modify its Properties

Read the 3-D coordinate points into the workspace.

```
load('xyzPoints');
```

Create a point cloud object from the input point coordinates.

```
ptCloud = pointCloud(xyzPoints);
```

Inspect the properties of the point cloud object.

```
ptCloud
```

```
ptCloud =  
  pointCloud with properties:  
  
  Location: [5184x3 single]  
  Count: 5184  
  XLimits: [-3 3.4338]  
  YLimits: [-2 2]  
  ZLimits: [0.0016 3.1437]  
  Color: []  
  Normal: []  
  Intensity: []
```

Display the point cloud by using `pcshow`.

```
pcshow(ptCloud)
```

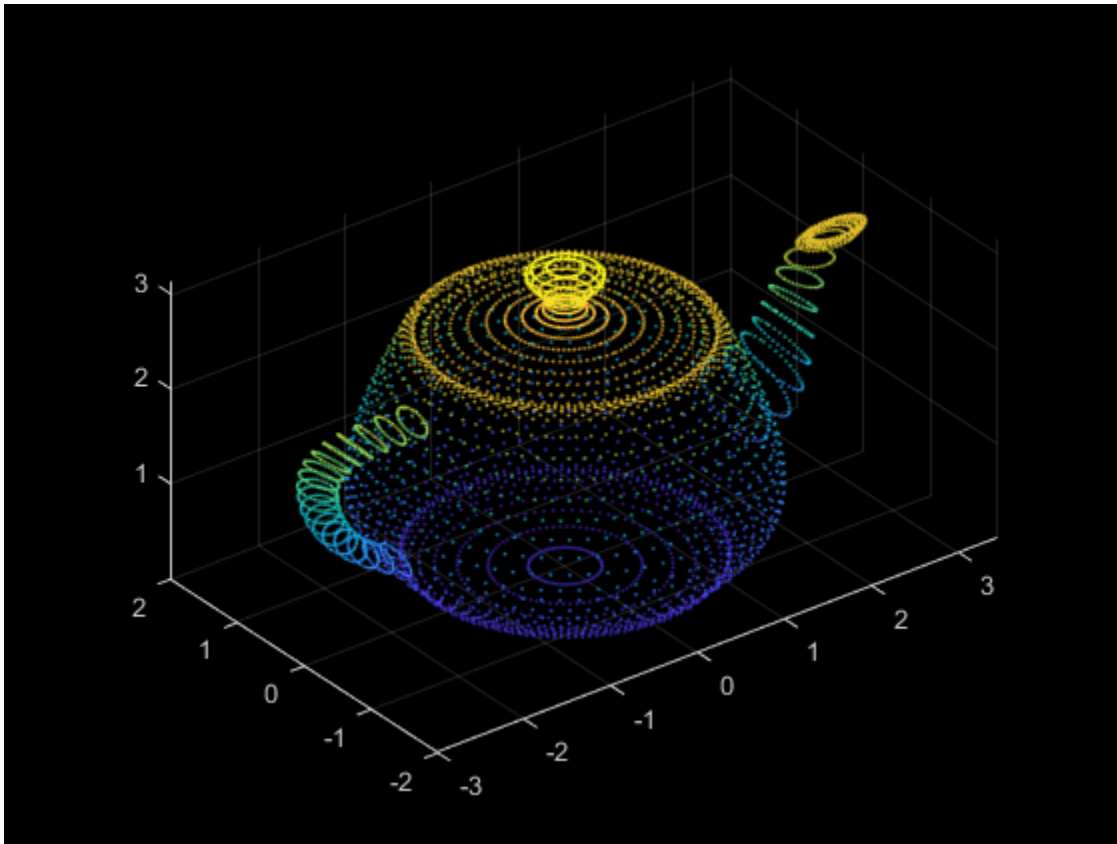
**Modify Color of Point Cloud Data**

Create an RGB color array of size same as the size of the point cloud data. Set the point colors to Red.

```
cmatrix = ones(size(ptCloud.Location)).*[1 0 0];
```

Create the point cloud object with the color property set to the RGB color array.

```
ptCloud = pointCloud(xyzPoints, 'Color', cmatrix);  
pcshow(ptCloud)
```

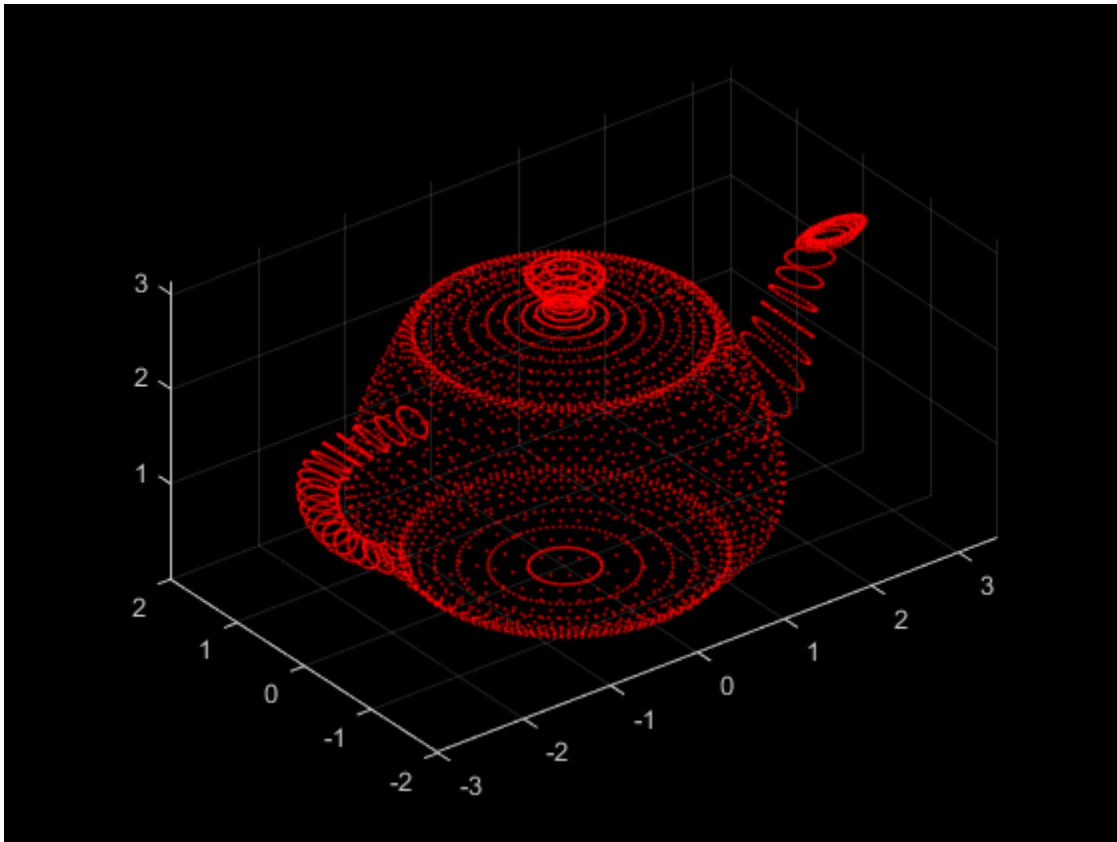

Add Surface Normals to Point Cloud Data

Compute surface normals corresponding to the point cloud data using `pcnormals`.

```
normals = pcnormals(ptCloud);
```

Create point cloud object from input point coordinates. Add the computed surface normals to point cloud object.

```
ptCloud = pointCloud(xyzPoints, 'Normal', normals);
```

Display the point cloud and plot the surface normals.

```
pcshow(ptCloud)
x = ptCloud.Location(:,1);
y = ptCloud.Location(:,2);
z = ptCloud.Location(:,3);
u = normals(:,1);
v = normals(:,2);
w = normals(:,3);
hold on
quiver3(x,y,z,u,v,w);
hold off
```

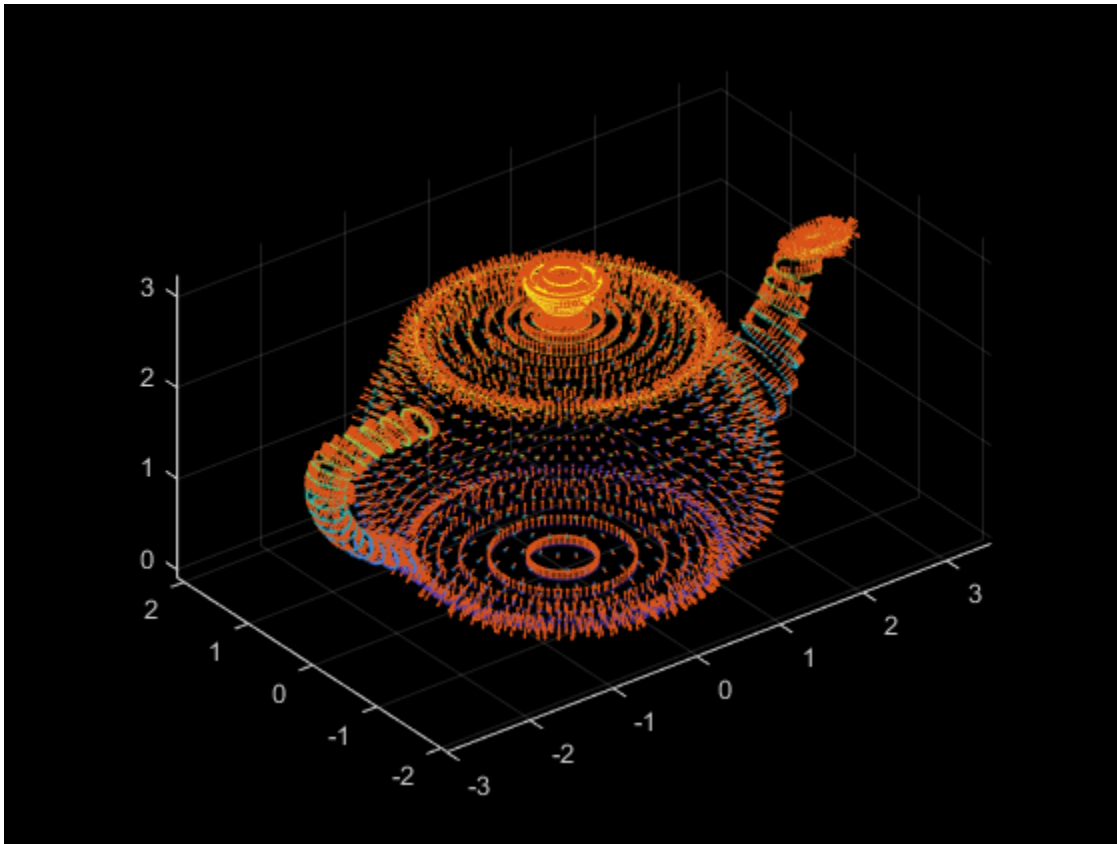

Tips

The `pointCloud` object is a handle object. If you want to create a separate copy of a point cloud, you can use the MATLAB `copy` method.

```
ptCloudB = copy(ptCloudA)
```

If you want to preserve a single copy of a point cloud, which can be modified by point cloud functions, use the same point cloud variable name for the input and output.

```
ptCloud = pcFunction(ptCloud)
```

Extended Capabilities

C/C++ Code Generation

Generate C and C++ code using MATLAB® Coder™.

GPU Code Generation

Generate CUDA® code for NVIDIA® GPUs using GPU Coder™.

Usage notes and limitations:

- GPU code generation for variable input sizes is not optimized. Consider using constant size inputs for an optimized code generation.
- GPU code generation supports the 'Color', 'Normal', and 'Intensity' name-value pairs.

- GPU code generation supports the `findNearestNeighbors`, `findNeighborsInRadius`, `findPointsInROI`, `removeInvalidPoints`, and `select` methods.
- For very large inputs, the memory requirements of the algorithm may exceed the GPU device limits. In such cases, consider reducing the input size to proceed with code generation.

See Also

Functions

`pccat` | `pccalign` | `pcshow` | `pcwrite` | `pcread` | `pcmerge` | `pcdenoise` | `pcnormals` | `pcplayer`

Topics

“3-D Point Cloud Registration and Stitching”

“Coordinate Systems”

Introduced in R2015a

findNearestNeighbors

Find nearest neighbors of a point in point cloud

Syntax

```
[indices,dists] = findNearestNeighbors(ptCloud,point,K)
[indices,dists] = findNearestNeighbors(ptCloud,point,K,camMatrix)
[indices,dists] = findNearestNeighbors( ____,Name,Value)
```

Description

`[indices,dists] = findNearestNeighbors(ptCloud,point,K)` returns the indices for the K-nearest neighbors of a query point in the input point cloud. `ptCloud` can be an unorganized or organized point cloud. The K-nearest neighbors of the query point are computed by using the Kd-tree based search algorithm.

`[indices,dists] = findNearestNeighbors(ptCloud,point,K,camMatrix)` returns the K-nearest neighbors of a query point in the input point cloud. The input point cloud is an organized point cloud generated by a depth camera. The K-nearest neighbors of the query point are determined using fast approximate K-nearest neighbor search algorithm.

The function uses the camera projection matrix `camMatrix` to know the relationship between adjacent points and hence, speeds up the nearest neighbor search. However, the results have lower accuracy as compared to the Kd-tree based approach.

Note

- This syntax only supports organized point cloud data produced by RGB-D sensors.
 - You can use `estimateCameraMatrix` to estimate camera projection matrix for the given point cloud data.
-

`[indices,dists] = findNearestNeighbors(____,Name,Value)` specifies options using one or more name-value arguments in addition to the input arguments in the preceding syntaxes.

Examples

Find K-Nearest Neighbors in a Point Cloud

Load a set of 3-D coordinate points into the workspace.

```
load('xyzPoints.mat');
```

Create a point cloud object.

```
ptCloud = pointCloud(xyzPoints);
```

Specify a query point and the number of nearest neighbors to be identified.

```
point = [0,0,0];
K = 220;
```

Get the indices and the distances of K nearest neighboring points.

```
[indices,dists] = findNearestNeighbors(ptCloud,point,K);
```

Display the point cloud. Plot the query point and their nearest neighbors.

```
figure
pcshow(ptCloud)
hold on
plot3(point(1),point(2),point(3),'*r')
plot3(ptCloud.Location(indices,1),ptCloud.Location(indices,2),ptCloud.Location(indices,3),'*')
legend('Point Cloud','Query Point','Nearest Neighbors','Location','southoutside','Color',[1 1 1])
hold off
```

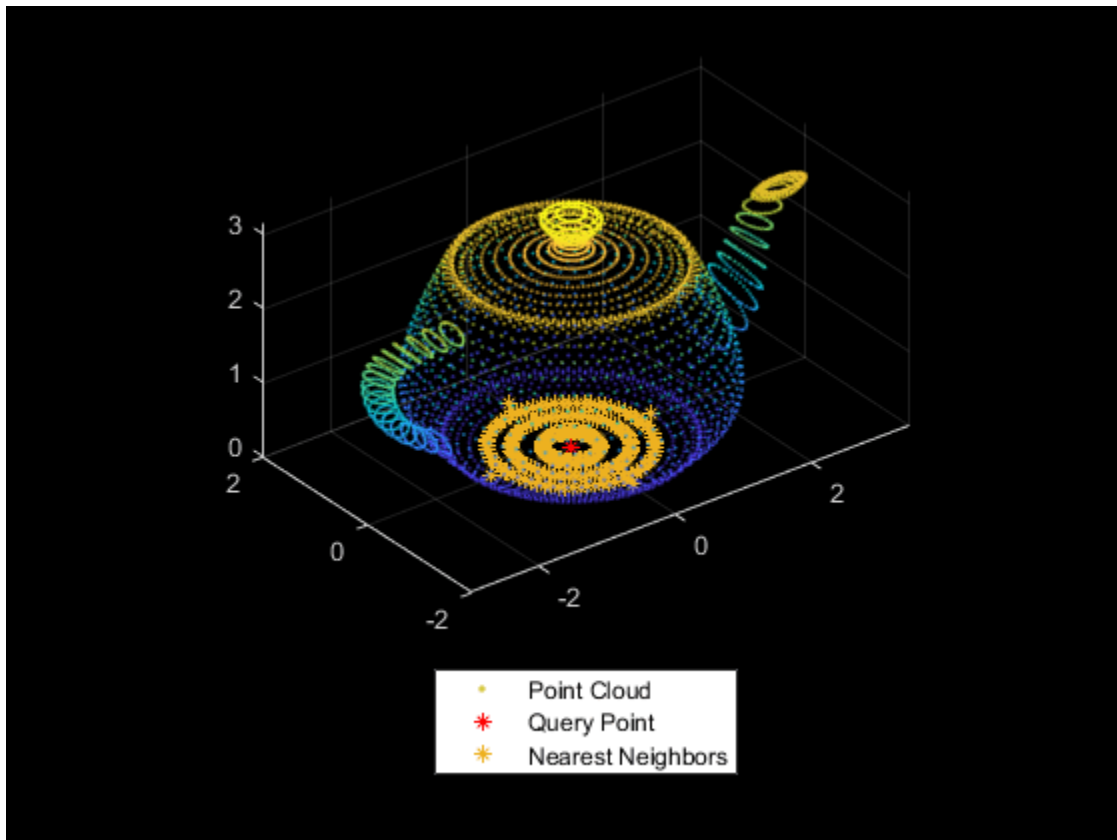

Find K-Nearest Neighbors in Organized Point Cloud

Find the K-nearest neighbors of a query point in the organized point cloud data by using the camera projection matrix. Compute the camera projection matrix from sampled point cloud data points and their corresponding image point coordinates.

Load an organized point cloud data into the workspace. The point cloud is generated by using the Kinect depth sensor.

```
ld = load('object3d.mat');  
ptCloud = ld.ptCloud;
```

Specify the step size for sampling the point cloud data.

```
stepSize = 100;
```

Sample the input point cloud and store the sampled 3-D point coordinates as a point cloud object.

```
indices = 1:stepSize:ptCloud.Count;  
tempPtCloud = select(ptCloud,indices);
```

Remove invalid points from the sampled point cloud.

```
[tempPtCloud,validIndices] = removeInvalidPoints(tempPtCloud);
```

Define the 3-D world point coordinates of input point cloud.

```
worldPoints = tempPtCloud.Location;
```

Find the 2-D image coordinates corresponding to the 3-D point coordinates of input point cloud.

```
[Y,X] = ind2sub([size(ptCloud.Location,1),size(ptCloud.Location,2)],indices);  
imagePoints = [X(validIndices)' Y(validIndices)'];
```

Estimate camera projection matrix from the image and the world point coordinates.

```
camMatrix = estimateCameraMatrix(imagePoints,worldPoints);
```

Specify a query point and the number of nearest neighbors to be identified.

```
point = [0.4 0.3 0.2];  
K = 20;
```

Find the indices and distances of K nearest neighboring points by using the camera projection matrix. Use the point cloud method `select` to get the point cloud data of nearest neighbors.

```
[indices,dists] = findNearestNeighbors(ptCloud,point,K,camMatrix);  
ptCloudB = select(ptCloud,indices);
```

Display the point cloud and the nearest neighbors of the query point.

```
figure  
pcshow(ptCloud)  
hold on  
pcshow(ptCloudB.Location,'ob')  
legend('Point Cloud','Nearest Neighbors','Location','southoutside','Color',[1 1 1])  
hold off
```

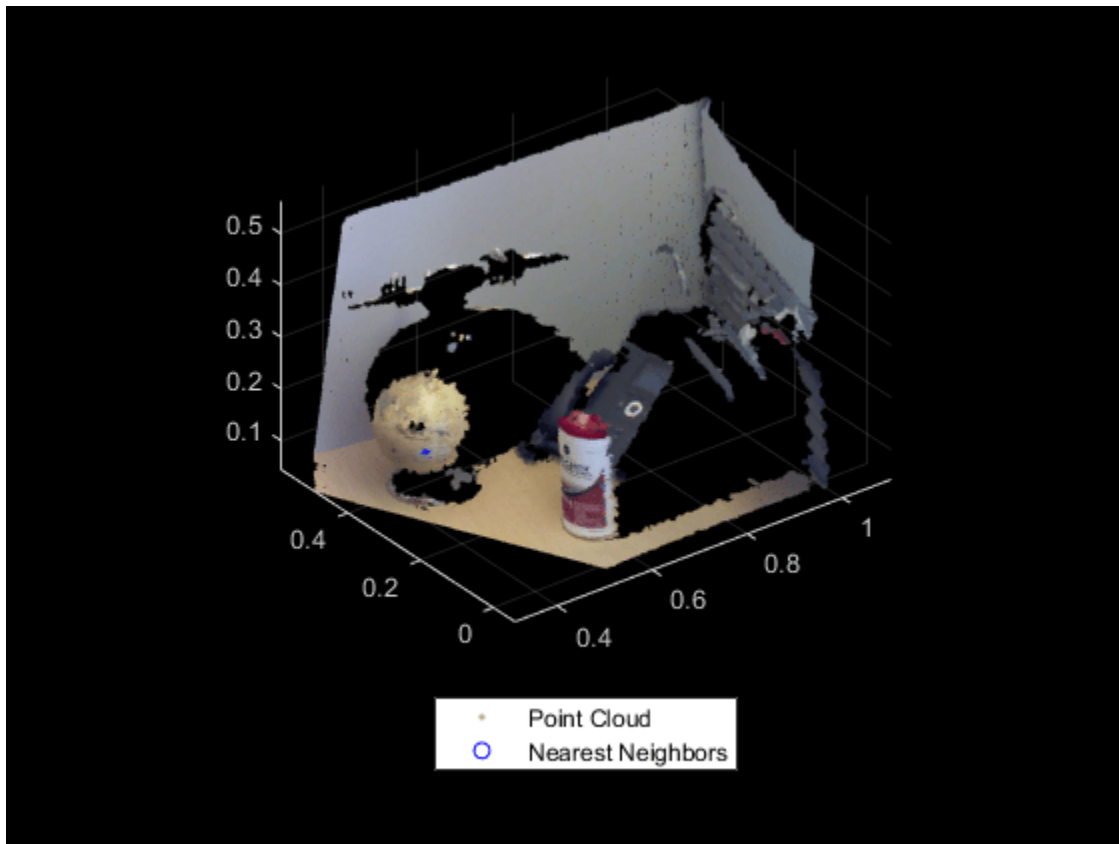
Input Arguments

ptCloud — Point cloud

pointCloud object

Point cloud, specified as a pointCloud object.

Note The function supports organized point cloud data generated only from RGB-D sensors.

point — Query point

three-element vector of form $[x, y, z]$

Query point, specified as a three-element vector of form $[x, y, z]$.

K — Number of nearest neighbors

positive integer

Number of nearest neighbors, specified as a positive integer.

camMatrix — Camera projection matrix

4-by-3 matrix

Camera projection matrix, specified as a 4-by-3 matrix that maps 3-D world points to 2-D image points. You can compute the `camMatrix` by using the `estimateCameraMatrix` function.

Name-Value Pair Arguments

Specify optional comma-separated pairs of `Name`, `Value` arguments. `Name` is the argument name and `Value` is the corresponding value. `Name` must appear inside quotes. You can specify several name and value pair arguments in any order as `Name1, Value1, ..., NameN, ValueN`.

Example: `findNearestNeighbors(ptCloud, point, k, 'Sort', true)`

Sort — Sort indices

`false` (default) | `true`

Sort indices, specified as a comma-separated pair of `'Sort'` and a logical scalar. When you set `Sort` to `true`, the returned indices are sorted in the ascending order based on the distance from a query point. To turn off sorting, set `Sort` to `false`.

MaxLeafChecks — Number of leaf nodes to check

`Inf` (default) | integer

Number of leaf nodes to check, specified as a comma-separated pair consisting of `'MaxLeafChecks'` and an integer. When you set this value to `Inf`, the entire tree is searched. When the entire tree is searched, it produces exact search results. Increasing the number of leaf nodes to check increases accuracy, but reduces efficiency.

Note The name-value argument `'MaxLeafChecks'` is valid only with Kd-tree based search method.

Output Arguments

indices — Indices of stored points

column vector

Indices of stored points, returned as a column vector. The vector contains K linear indices of the nearest neighbors stored in the point cloud.

dists — Distances to query point

column vector

Distances to query point, returned as a column vector. The vector contains the Euclidean distances between the query point and its nearest neighbors.

References

- [1] Muja, M. and David G. Lowe. "Fast Approximate Nearest Neighbors with Automatic Algorithm Configuration". In *VISAPP International Conference on Computer Vision Theory and Applications*. 2009. pp. 331-340.

Extended Capabilities

C/C++ Code Generation

Generate C and C++ code using MATLAB® Coder™.

Usage notes and limitations:

- For code generation in non-host platforms, the value for 'MaxLeafChecks' must be set to the default value `Inf`. If you specify values other than `Inf`, the function generates a warning and automatically assigns the default value for 'MaxLeafChecks'.

GPU Code Generation

Generate CUDA® code for NVIDIA® GPUs using GPU Coder™.

Usage notes and limitations:

- For GPU code generation, the `camMatrix` input argument is ignored.
- For GPU code generation, the 'MaxLeafChecks' name-value pair option is ignored.

See Also

`pointCloud` | `estimateCameraMatrix` | `cameraMatrix`

Introduced in R2015a

findNeighborsInRadius

Find neighbors within a radius of a point in the point cloud

Syntax

```
[indices,dists] = findNeighborsInRadius(ptCloud,point,radius)
[indices,dists] = findNeighborsInRadius(ptCloud,point,radius,camMatrix)
[indices,dists] = findNeighborsInRadius( ____,Name,Value)
```

Description

`[indices,dists] = findNeighborsInRadius(ptCloud,point,radius)` returns the indices of neighbors within a radius of a query point in the input point cloud. `ptCloud` can be an unorganized or organized point cloud. The neighbors within a radius of the query point are computed by using the Kd-tree based search algorithm.

`[indices,dists] = findNeighborsInRadius(ptCloud,point,radius,camMatrix)` returns the neighbors within a radius of a query point in the input point cloud. The input point cloud is an organized point cloud generated by a depth camera. The neighbors within a radius of the query point are determined using fast approximate neighbor search algorithm.

The function uses the camera projection matrix `camMatrix` to know the relationship between adjacent points and hence, speeds up the search. However, the results have lower accuracy as compared to the Kd-tree based approach.

Note

- This syntax only supports organized point cloud data produced by RGB-D sensors.
 - You can use `estimateCameraMatrix` to estimate camera projection matrix for the given point cloud data.
-

`[indices,dists] = findNeighborsInRadius(____,Name,Value)` specifies options using one or more name-value pair arguments in addition to the input arguments in the preceding syntaxes.

Examples

Find Radial Neighbors in Point Cloud

Load a set of 3-D coordinate points into the workspace.

```
load('xyzPoints.mat');
```

Create a point cloud object.

```
ptCloud = pointCloud(xyzPoints);
```

Specify a query point and the radius within which the neighbors are to be identified.

```
point = [0,0,3];
radius = 0.5;
```

Get the indices and the distances of points that lie within the specified radius.

```
[indices,dists] = findNeighborsInRadius(ptCloud,point,radius);
```

Get the point cloud data of radial neighbors.

```
ptCloudB = select(ptCloud,indices);
```

Display the point cloud. Plot the query point and the corresponding radial neighbors.

```
figure
pcshow(ptCloud)
hold on
plot3(point(1),point(2),point(3),'*')
pcshow(ptCloudB.Location,'r')
legend('Point Cloud','Query Point','Radial Neighbors','Location','southoutside','Color',[1 1 1])
hold off
```

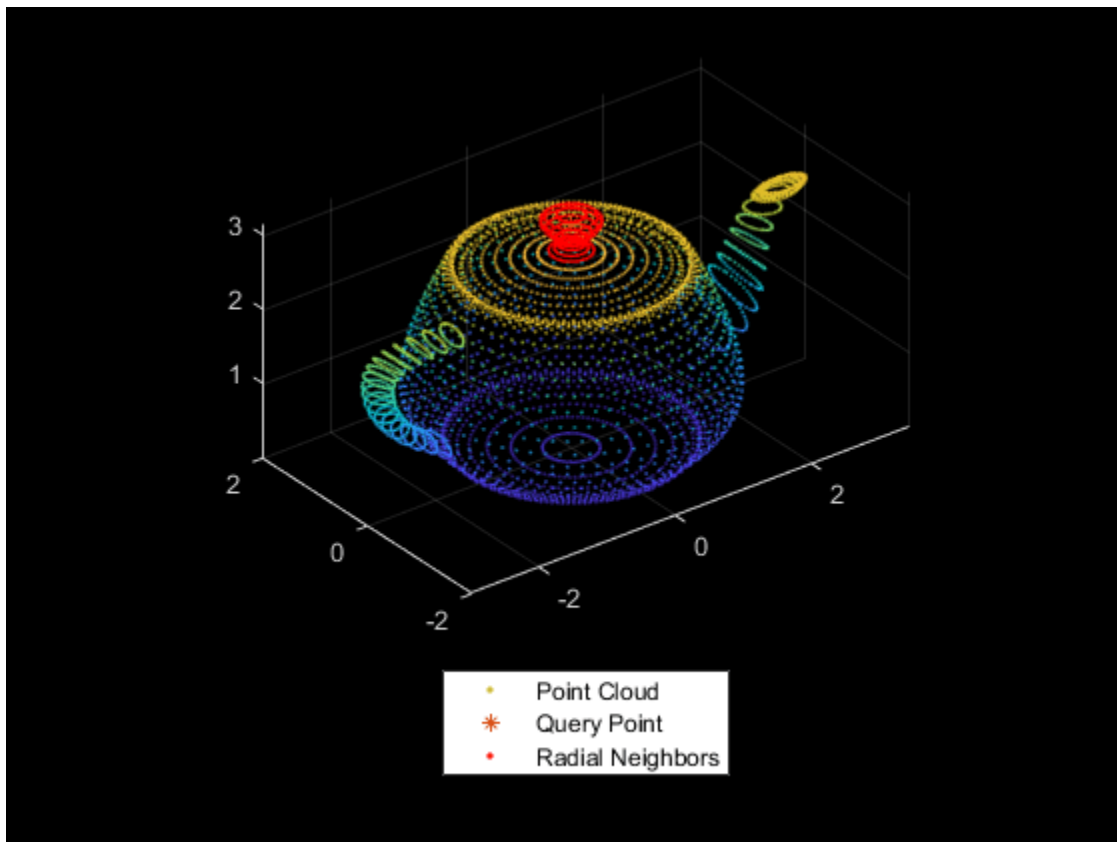

Find Radial Neighbors in Organized Point Cloud

Find radial neighbors of a query point in the organized point cloud data by using the camera projection matrix. Compute the camera projection matrix from sampled point cloud data points and their corresponding image point coordinates.

Load an organized point cloud data into the workspace. The point cloud is generated by using the Kinect depth sensor.

```
ld = load('object3d.mat');  
ptCloud = ld.ptCloud;
```

Specify the step size for sampling the point cloud data.

```
stepSize = 100;
```

Sample the input point cloud and store the sampled 3-D point coordinates as a point cloud object.

```
indices = 1:stepSize:ptCloud.Count;  
tempPtCloud = select(ptCloud,indices);
```

Remove invalid points from the sampled point cloud.

```
[tempPtCloud,validIndices] = removeInvalidPoints(tempPtCloud);
```

Define the 3-D world point coordinates of input point cloud.

```
worldPoints = tempPtCloud.Location;
```

Find the 2-D image coordinates corresponding to the 3-D point coordinates of input point cloud.

```
[Y,X] = ind2sub([size(ptCloud.Location,1),size(ptCloud.Location,2)],indices);  
imagePoints = [X(validIndices)' Y(validIndices)'];
```

Estimate camera projection matrix from the image and the world point coordinates.

```
camMatrix = estimateCameraMatrix(imagePoints,worldPoints);
```

Specify a query point and the radius within which the neighbors are to be identified.

```
point = [0.4 0.3 0.2];  
radius = 0.05;
```

Get the indices and the distances of radial neighbors. Use the point cloud method `select` to get the point cloud data of neighboring points.

```
[indices,dists] = findNeighborsInRadius(ptCloud,point,radius,camMatrix);  
ptCloudB = select(ptCloud,indices);
```

Display the point cloud and the radial neighbors found around a query point.

```
figure  
pcshow(ptCloud);  
hold on;  
pcshow(ptCloudB.Location, 'b');  
legend('Point Cloud','Radial Neighbors','Location','southoutside','Color',[1 1 1] )  
hold off;
```

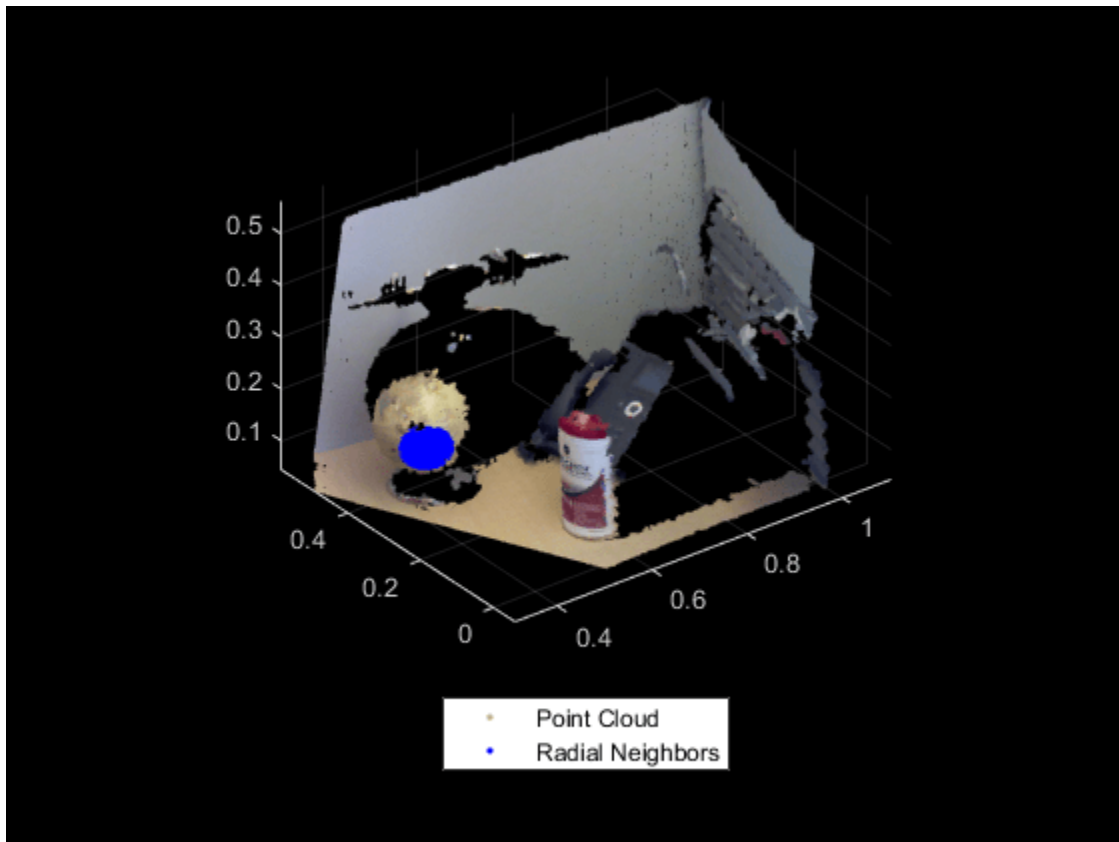

Input Arguments

ptCloud — Point cloud

pointCloud object

Point cloud, specified as a pointCloud object.

point — Query point

three-element vector of form $[x, y, z]$

Query point, specified as a three-element vector of form $[x, y, z]$.

radius — Search radius

scalar

Search radius, specified as a scalar. The function finds the neighbors within the specified radius around a query point in the input point cloud.

camMatrix — Camera projection matrix

4-by-3 matrix

Camera projection matrix, specified as a 4-by-3 matrix that maps 3-D world points to 2-D image points. You can find camMatrix by using the estimateCameraMatrix function.

Name-Value Pair Arguments

Specify optional comma-separated pairs of `Name`, `Value` arguments. `Name` is the argument name and `Value` is the corresponding value. `Name` must appear inside quotes. You can specify several name and value pair arguments in any order as `Name1, Value1, . . . , NameN, ValueN`.

Example: `findNeighborsInRadius(ptCloud, point, radius, 'Sort', true)`

Sort — Sort indices

`false` (default) | `true`

Sort indices, specified as a comma-separated pair of `'Sort'` and a logical scalar. When you set `Sort` to `true`, the returned indices are sorted in the ascending order based on the distance from a query point. To turn off sorting, set `Sort` to `false`.

MaxLeafChecks — Number of leaf nodes

`Inf` (default) | integer

Number of leaf nodes, specified as a comma-separated pair consisting of `'MaxLeafChecks'` and an integer. When you set this value to `Inf`, the entire tree is searched. When the entire tree is searched, it produces exact search results. Increasing the number of leaf nodes to check increases accuracy, but reduces efficiency.

Output Arguments

indices — Indices of stored points

column vector

Indices of stored points, returned as a column vector. The vector contains the linear indices of the radial neighbors stored in the point cloud.

dists — Distances to query point

column vector

Distances to query point, returned as a column vector. The vector contains the Euclidean distances between the query point and its radial neighbors.

References

- [1] Muja, M. and David G. Lowe. "Fast Approximate Nearest Neighbors with Automatic Algorithm Configuration". In *VISAPP International Conference on Computer Vision Theory and Applications*. 2009. pp. 331-340.

Extended Capabilities

C/C++ Code Generation

Generate C and C++ code using MATLAB® Coder™.

Usage notes and limitations:

- For code generation in non-host platforms, the value for `'MaxLeafChecks'` must be set to the default value `Inf`. If you specify values other than `Inf`, the function generates a warning and automatically assigns the default value for `'MaxLeafChecks'`.

GPU Code Generation

Generate CUDA® code for NVIDIA® GPUs using GPU Coder™.

Usage notes and limitations:

- For GPU code generation, the `camMatrix` input argument is ignored.
- For GPU code generation, the `'MaxLeafChecks'` name-value pair option is ignored.

See Also

`pointCloud` | `estimateCameraMatrix` | `cameraMatrix`

Introduced in R2015a

findPointsInROI

Find points within a region of interest in the point cloud

Syntax

```
indices = findPointsInROI(ptCloud,roi)
indices = findpointsInROI(ptCloud,roi,camMatrix)
```

Description

`indices = findPointsInROI(ptCloud,roi)` returns the points within a region of interest (ROI) in the input point cloud. The points within the specified ROI are obtained using a Kd-tree based search algorithm.

`indices = findpointsInROI(ptCloud,roi,camMatrix)` returns the points within the ROI area of the input point cloud. The input point cloud is an organized point cloud generated by a depth camera. The points within the specified ROI are obtained using fast approximate neighbor search algorithm.

The function uses the camera projection matrix `camMatrix` to know the relationship between adjacent points and hence, speeds up the search. However, the results have lower accuracy as compared to the Kd-tree based approach.

Note

- This syntax only supports organized point cloud data produced by RGB-D sensors.
 - You can use `estimateCameraMatrix` to estimate camera projection matrix for the given point cloud data.
-

Examples

Find Points Within a Cuboid ROI in Point Cloud

Read a point cloud data into the workspace.

```
ptCloud = pcread('teapot.ply');
```

Define a cuboid ROI within the range of the x , y and z coordinates of the input point cloud.

```
roi = [-2 2 -2 2 2.4 3.5];
```

Find the indices of the points that lie within the cuboid ROI.

```
indices = findPointsInROI(ptCloud,roi);
```

Select the points that lie within the cuboid ROI and store as a point cloud object.

```
ptCloudB = select(ptCloud,indices);
```

Display the input point cloud and the point cloud within the specified ROI.

```
figure
pcshow(ptCloud.Location,[0.5 0.5 0.5])
hold on
pcshow(ptCloudB.Location,'r');
legend('Point Cloud','Points within ROI','Location','southoutside','Color',[1 1 1])
hold off
```

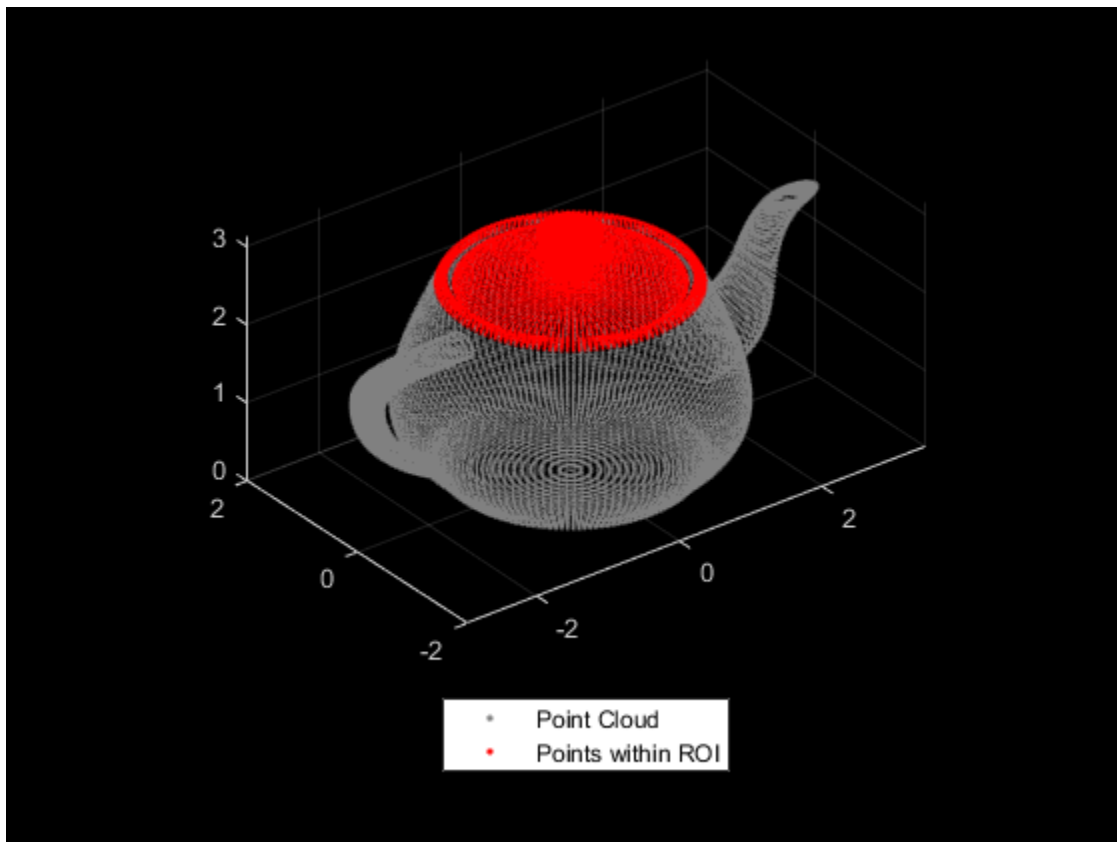

Find Points Within a Cuboid ROI in Organized Point Cloud

Find points within a cuboid ROI in the organized point cloud data by using the camera projection matrix. Compute the camera projection matrix from sampled point cloud data points and their corresponding image point coordinates.

Load an organized point cloud data into the workspace. The point cloud is generated by using the Kinect depth sensor.

```
ld = load('object3d.mat');
ptCloud = ld.ptCloud;
```

Specify the step size for sampling the point cloud data.

```
stepSize = 100;
```

Sample the input point cloud and store the sampled 3-D point coordinates as a point cloud object.

```
indices = 1:stepSize:ptCloud.Count;  
tempPtCloud = select(ptCloud,indices);
```

Remove invalid points from the sampled point cloud.

```
[tempPtCloud,validIndices] = removeInvalidPoints(tempPtCloud);
```

Get the 3-D world point coordinates from input point cloud.

```
worldPoints = tempPtCloud.Location;
```

Find the 2-D image coordinates corresponding to the 3-D point coordinates of input point cloud.

```
[Y,X] = ind2sub([size(ptCloud.Location,1),size(ptCloud.Location,2)],indices);  
imagePoints = [X(validIndices)' Y(validIndices)'];
```

Estimate camera projection matrix from the image and the world point coordinates.

```
camMatrix = estimateCameraMatrix(imagePoints,worldPoints);
```

Specify a cuboid ROI within the range of the x, y and z coordinates of the input point cloud.

```
roi = [0.3 0.7 0 0.4 0.1 0.3];
```

Find the indices of the point cloud data that lie within the cuboid ROI.

```
indices = findPointsInROI(ptCloud,roi,camMatrix);
```

Use the point cloud method `select` to get the point cloud data of points within the ROI.

```
ptCloudB = select(ptCloud,indices);
```

Display the input point cloud and the points within the cuboid ROI.

```
figure  
pcshow(ptCloud)  
hold on  
pcshow(ptCloudB.Location,'r');  
legend('Point Cloud','Points within the ROI','Location','southoutside','Color',[1 1 1])  
hold off
```

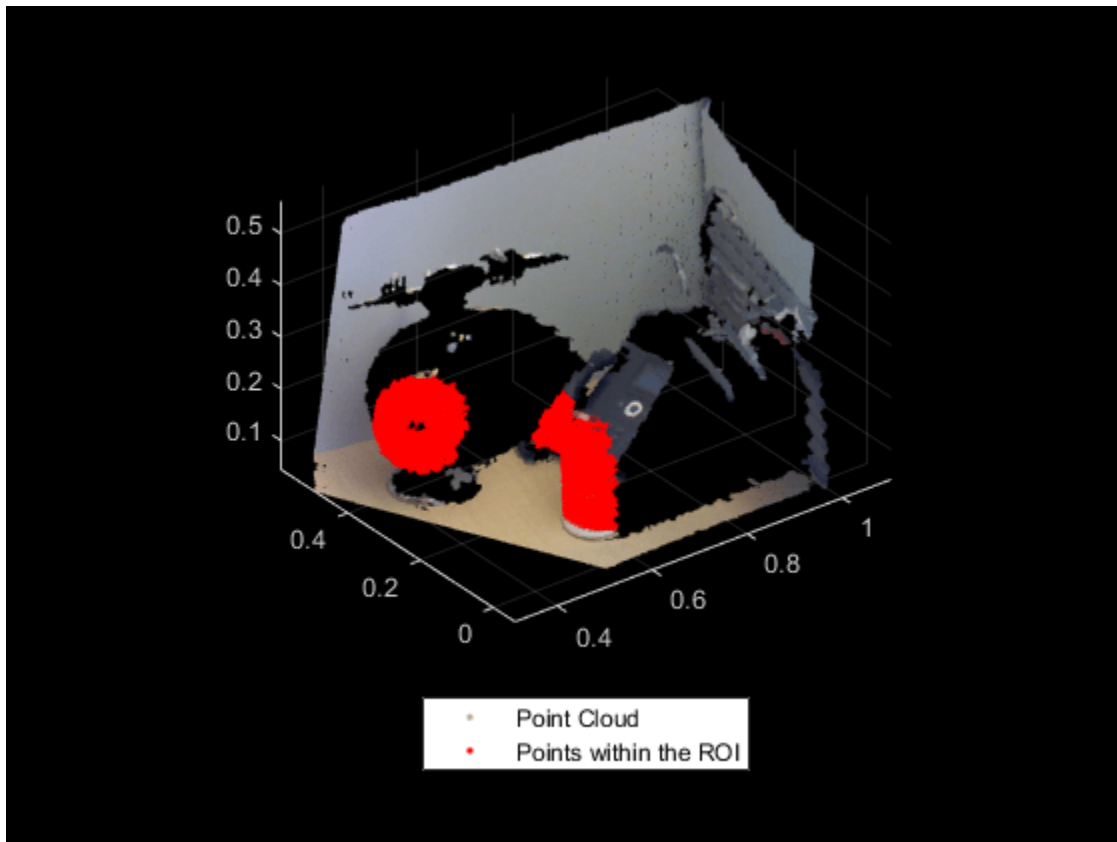

Input Arguments

ptCloud — Point cloud

pointCloud object

Point cloud, specified as a pointCloud object.

roi — Region of interest

six-element vector

Region of interest, specified as a six-element vector of form $[xmin, xmax, ymin, ymax, zmin, zmax]$, where:

- $xmin$ and $xmax$ are the minimum and the maximum limits along the x -axis respectively.
- $ymin$ and $ymax$ are the minimum and the maximum limits along the y -axis respectively.
- $zmin$ and $zmax$ are the minimum and the maximum limits along the z -axis respectively.

camMatrix — Camera projection matrix

4-by-3 matrix

Camera projection matrix, specified as a 4-by-3 matrix that maps 3-D world points to 2-D image points. You can find camMatrix by using the estimateCameraMatrix function.

Output Arguments

indices — Indices of stored points

column vector

Indices of stored points, returned as a column vector. The vector contains the linear indices of the ROI points stored in the point cloud.

References

- [1] Muja, M. and David G. Lowe. "Fast Approximate Nearest Neighbors with Automatic Algorithm Configuration". In *VISAPP International Conference on Computer Vision Theory and Applications*. 2009. pp. 331-340.

Extended Capabilities

C/C++ Code Generation

Generate C and C++ code using MATLAB® Coder™.

GPU Code Generation

Generate CUDA® code for NVIDIA® GPUs using GPU Coder™.

Usage notes and limitations:

For GPU code generation, the `camMatrix` input argument is ignored.

See Also

`pointCloud` | `estimateCameraMatrix` | `cameraMatrix`

Introduced in R2015a

removeInvalidPoints

Remove invalid points from point cloud

Syntax

```
[ptCloudOut,indices] = removeInvalidPoints(ptCloud)
```

Description

`[ptCloudOut,indices] = removeInvalidPoints(ptCloud)` removes points with `Inf` or `NaN` coordinate values from point cloud and returns the indices of valid points.

Examples

Remove Invalid Points from Point Cloud

Create a point cloud object with `NaN` and `Inf` values.

```
xyzpoints = abs(randn(10,3)).*100;
xyzpoints(1:2:4,:) = nan('single');
xyzpoints(6:2:10,:) = inf('single');
ptCloud = pointCloud(xyzpoints);
```

Inspect the `Location` property of point cloud data to verify the occurrence of `NaN` and `Inf` values.

```
ptCloud.Location
```

```
ans = 10×3
```

NaN	NaN	NaN
183.3885	303.4923	120.7487
NaN	NaN	NaN
86.2173	6.3055	163.0235
31.8765	71.4743	48.8894
Inf	Inf	Inf
43.3592	12.4144	72.6885
Inf	Inf	Inf
357.8397	140.9034	29.3871
Inf	Inf	Inf

Remove points with `NaN` and `Inf` values from the point cloud.

```
ptCloudOut = removeInvalidPoints(ptCloud);
```

Inspect the `Location` property of point cloud data to verify that the invalid points are removed.

```
ptCloudOut.Location
```

```
ans = 5×3
```

183.3885	303.4923	120.7487
----------	----------	----------

86.2173	6.3055	163.0235
31.8765	71.4743	48.8894
43.3592	12.4144	72.6885
357.8397	140.9034	29.3871

Input Arguments

ptCloud — Point cloud

pointCloud object

Point cloud, specified as a pointCloud object.

Output Arguments

ptCloudOut — Point cloud with points removed

pointCloud object

Point cloud, returned as a pointCloud object with Inf or NaN coordinates removed.

Note The output is always an unorganized (X -by-3) point cloud. If the input `ptCloud` is an organized point cloud (M -by- N -by-3), the function returns the output as an unorganized point cloud.

indices — Indices of valid points

vector

Indices of valid points in the point cloud, specified as a vector.

Extended Capabilities

C/C++ Code Generation

Generate C and C++ code using MATLAB® Coder™.

GPU Code Generation

Generate CUDA® code for NVIDIA® GPUs using GPU Coder™.

See Also

pointCloud | pcread

Introduced in R2015a

select

Select points in point cloud

Syntax

```
ptCloudOut = select(ptCloud,indices)
ptCloudOut = select(ptCloud,row,column)
ptCloudOut = select( ____, 'OutputSize',outputSize)
```

Description

`ptCloudOut = select(ptCloud,indices)` returns a `pointCloud` object containing only the points that are selected using linear indices.

`ptCloudOut = select(ptCloud,row,column)` returns a `pointCloud` object containing only the points that are selected using row and column subscripts. This syntax applies only if the input is an organized point cloud data of size M -by- N -by-3.

`ptCloudOut = select(____, 'OutputSize',outputSize)` returns the selected points as a `pointCloud` object of size specified by `outputSize`.

Examples

Select Points from Point Cloud

Read a point cloud data into the workspace.

```
ptCloud = pcread('teapot.ply');
```

Read the number of points in the point cloud data.

```
Length = ptCloud.Count;
```

Select indices within the range [1, Length].

```
stepSize = 10;
indices = 1:stepSize:Length;
```

Select points specified by the indices from input point cloud. This selection of points downsamples the input point cloud by a factor of `stepSize`.

```
ptCloudB = select(ptCloud,indices);
```

Display the input and the selected point cloud data.

```
figure
subplot(1,2,1)
pcshow(ptCloud)
title('Input Point Cloud','Color',[1 1 1]);
subplot(1,2,2)
```

```
pcshow(ptCloudB)  
title('Selected Points','Color',[1 1 1]);
```

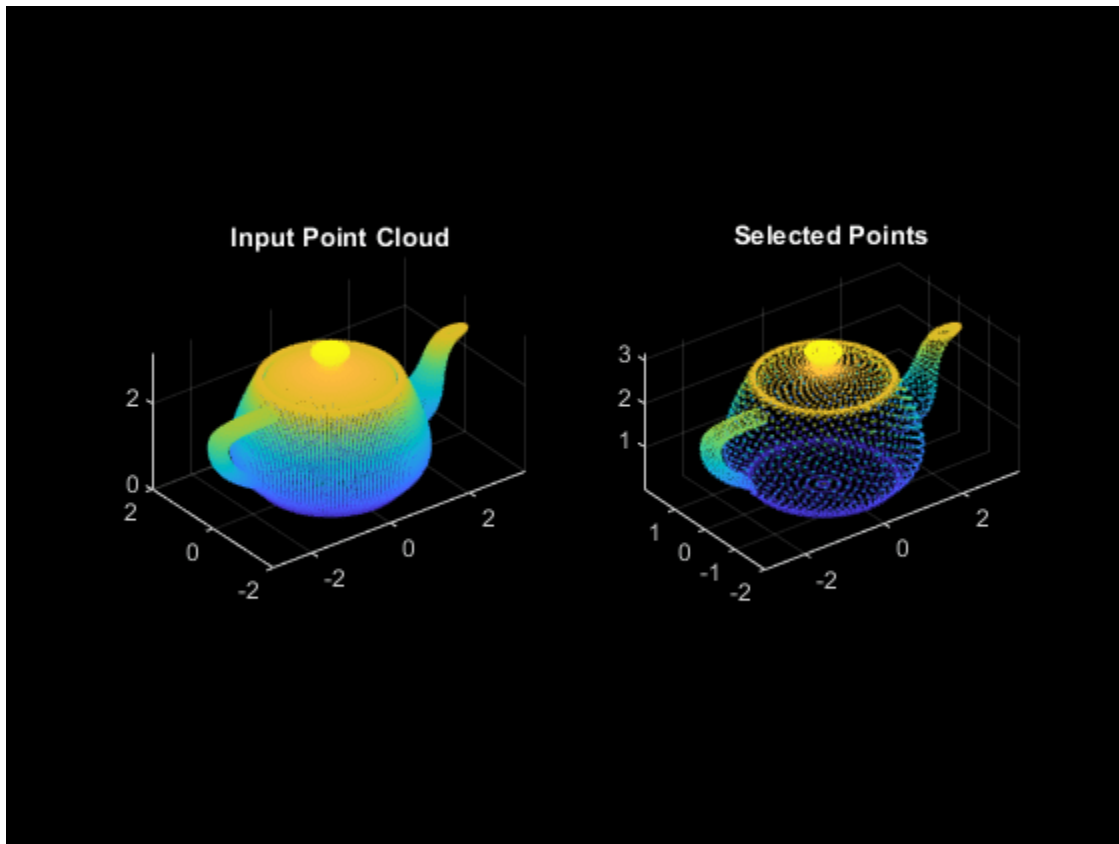

Input Arguments

ptCloud — Point cloud

pointCloud object

Point cloud, specified as a pointCloud object.

indices — Indices of selected points

vector

Indices of selected points, specified as a vector.

row — Row indices

vector

Row indices, specified as a vector. This argument applies only if the input is an organized point cloud data of size M -by- N -by-3.

column — Column indices

vector

Column indices, specified as a vector. This argument applies only if the input is an organized point cloud data of size M -by- N -by-3.

outputSize — Size of output point cloud`'selected' (default) | 'full'`

Size of the output point cloud, `ptCloudOut`, specified as `'selected'` or `'full'`.

- If the size is `'selected'`, then the output contains only the selected points from the input point cloud, `ptCloud`.
- If the size is `'full'`, then the output is same size as the input point cloud `ptCloud`. Cleared points are filled with NaN and the color is set to [0 0 0].

Output Arguments**ptCloudOut — Selected point cloud**`pointCloud` object

Point cloud, returned as a `pointCloud` object.

Extended Capabilities**C/C++ Code Generation**

Generate C and C++ code using MATLAB® Coder™.

GPU Code Generation

Generate CUDA® code for NVIDIA® GPUs using GPU Coder™.

See Also`pointCloud` | `pcread`

Introduced in R2015a

cylinderModel class

Object for storing a parametric cylinder model

Syntax

```
model = cylinderModel(params)
```

Description

Object for storing a parametric cylinder model.

Construction

`model = cylinderModel(params)` constructs a parametric cylinder model from the 1-by-7 `params` input vector that describes a cylinder.

Input Arguments

params — cylinder parameters

1-by-7 scalar vector

Cylinder parameters, specified as a 1-by-7 scalar vector containing seven parameters $[x1,y1,z1,x2,y2,z2,r]$ that describe a cylinder.

- $[x1,y1,z1]$ and $[x2,y2,z2]$ are the centers of each end-cap surface of the cylinder.
- r is the radius of the cylinder.

Properties

These properties are read-only.

Parameters — Cylinder model parameters

1-by-7 scalar vector

Cylinder model parameters, stored as a 1-by-7 scalar vector that describes a cylinder $[x1,y1,z1,x2,y2,z2,r]$ that describe a cylinder.

- $[x1,y1,z1]$ and $[x2,y2,z2]$ are the centers of each end-cap surface of the cylinder.
- r is the radius of the cylinder.

Center — Center of cylinder

1-by-3 vector

Center of cylinder, stored as a 1-by-3 vector.

Height — Height of cylinder

scalar

Height of cylinder, stored as a scalar.

Radius — Radius of cylinder

scalar

Radius of cylinder, stored as a scalar.

Methods

cylinderModel.plot Plot cylinder in a figure window

Examples**Detect Cylinder in Point Cloud**

Load the point cloud.

```
load('object3d.mat');
```

Display point cloud.

```
figure  
pcshow(ptCloud)  
xlabel('X(m)')  
ylabel('Y(m)')  
zlabel('Z(m)')  
title('Detect a Cylinder in a Point Cloud')
```

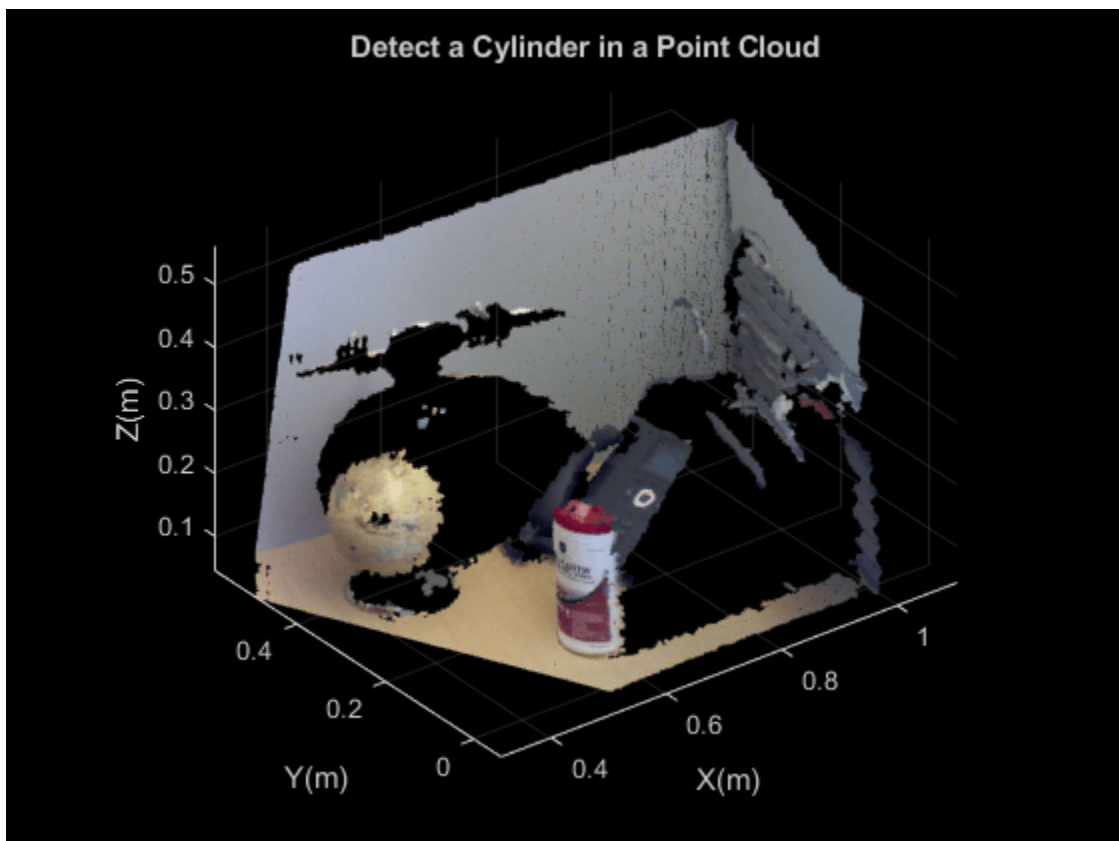

Set the maximum point-to-cylinder distance (5 mm) for the cylinder fitting.

```
maxDistance = 0.005;
```

Set the region of interest to constrain the search.

```
roi = [0.4,0.6;-inf,0.2;0.1,inf];  
sampleIndices = findPointsInROI(ptCloud,roi);
```

Set the orientation constraint.

```
referenceVector = [0,0,1];
```

Detect the cylinder in the point cloud and extract it.

```
model = pcfitcylinder(ptCloud,maxDistance,referenceVector,...  
    'SampleIndices',sampleIndices);
```

Plot the cylinder.

```
hold on  
plot(model)
```

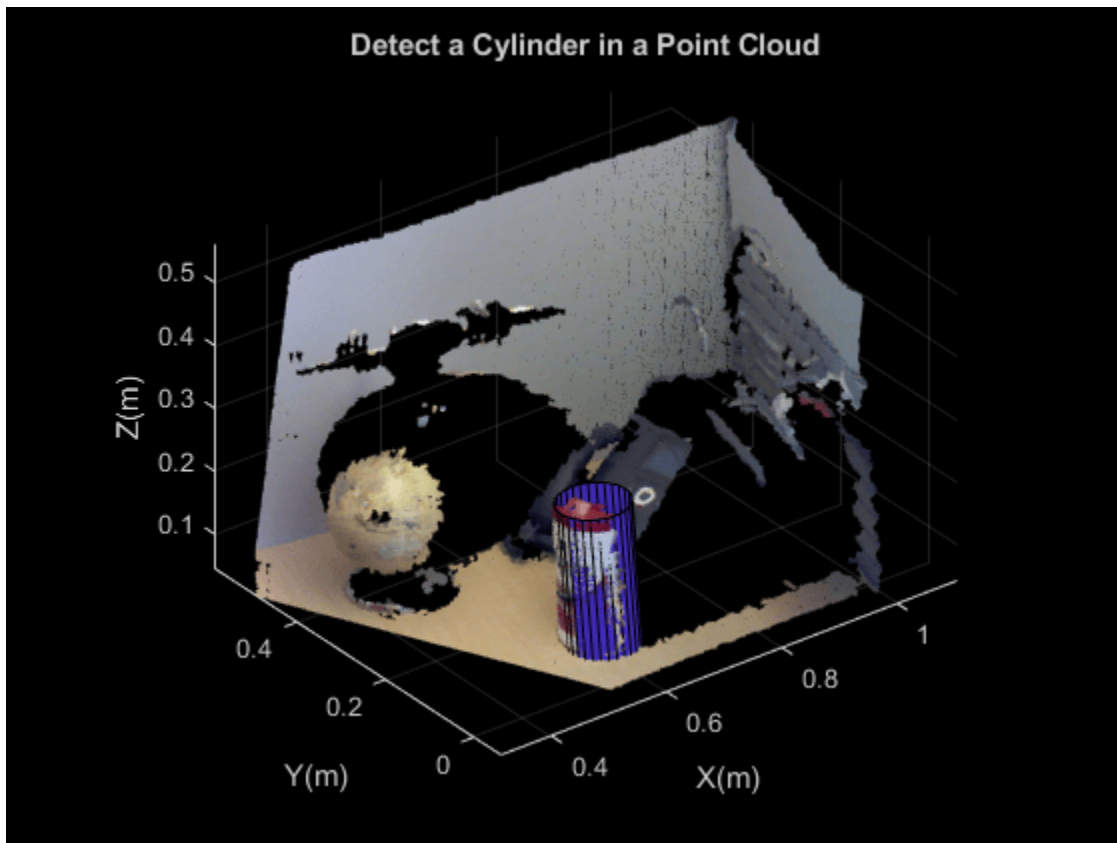

See Also

[pointCloud](#) | [pcfitcylinder](#) | [pcfitplane](#) | [pcfitsphere](#) | [planeModel](#) | [sphereModel](#) | [pcshow](#) | [pcplayer](#) | [pcwrite](#) | [pcread](#) | [pcmerge](#) | [pctransform](#) | [pcdownsample](#) | [pcdenoise](#) | [affine3d](#) | [pcregistericp](#)

Topics

“3-D Point Cloud Registration and Stitching”

Introduced in R2015b

cylinderModel.plot

Plot cylinder in a figure window

Syntax

```
plot(model)
plot(model, 'Parent', ax)
```

Description

`H = plot(model)` plots a cylinder within the axis limits of the current figure. `H` is the handle to surf, a 3-D shaded surface plot.

`H = plot(model, 'Parent', ax)` additionally specifies an output axes.

Input Arguments

model — Parametric cylinder model

cylinder model

Parametric cylinder model returned by `cylinderModel`.

'ax' — Output axes

gca (default) | axes

Output axes, specified as the current axes for displaying the cylinder.

Examples

Detect Cylinder in Point Cloud

Load the point cloud.

```
load('object3d.mat');
```

Display point cloud.

```
figure
pcshow(ptCloud)
xlabel('X(m)')
ylabel('Y(m)')
zlabel('Z(m)')
title('Detect a Cylinder in a Point Cloud')
```

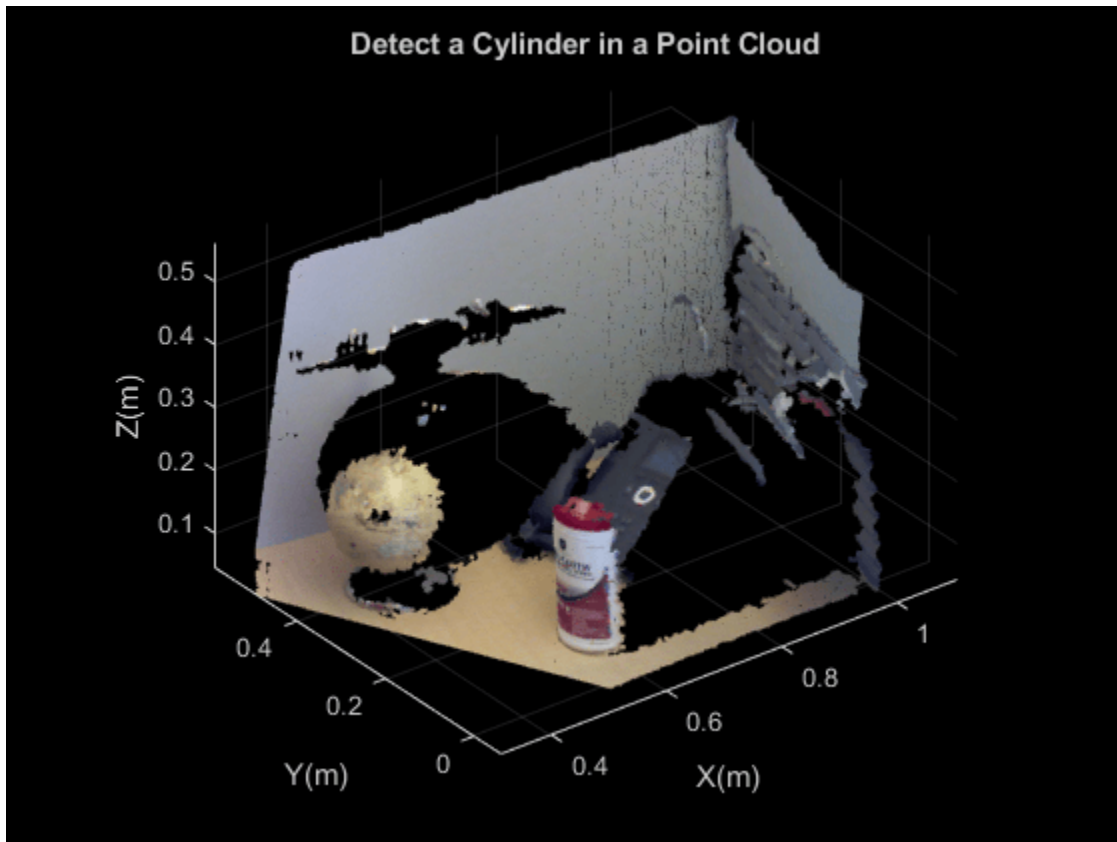
Set the maximum point-to-cylinder distance (5 mm) for the cylinder fitting.

```
maxDistance = 0.005;
```

Set the region of interest to constrain the search.

```
roi = [0.4,0.6;-inf,0.2;0.1,inf];  
sampleIndices = findPointsInROI(ptCloud,roi);
```

Set the orientation constraint.

```
referenceVector = [0,0,1];
```

Detect the cylinder in the point cloud and extract it.

```
model = pcfitcylinder(ptCloud,maxDistance,referenceVector,...  
    'SampleIndices',sampleIndices);
```

Plot the cylinder.

```
hold on  
plot(model)
```

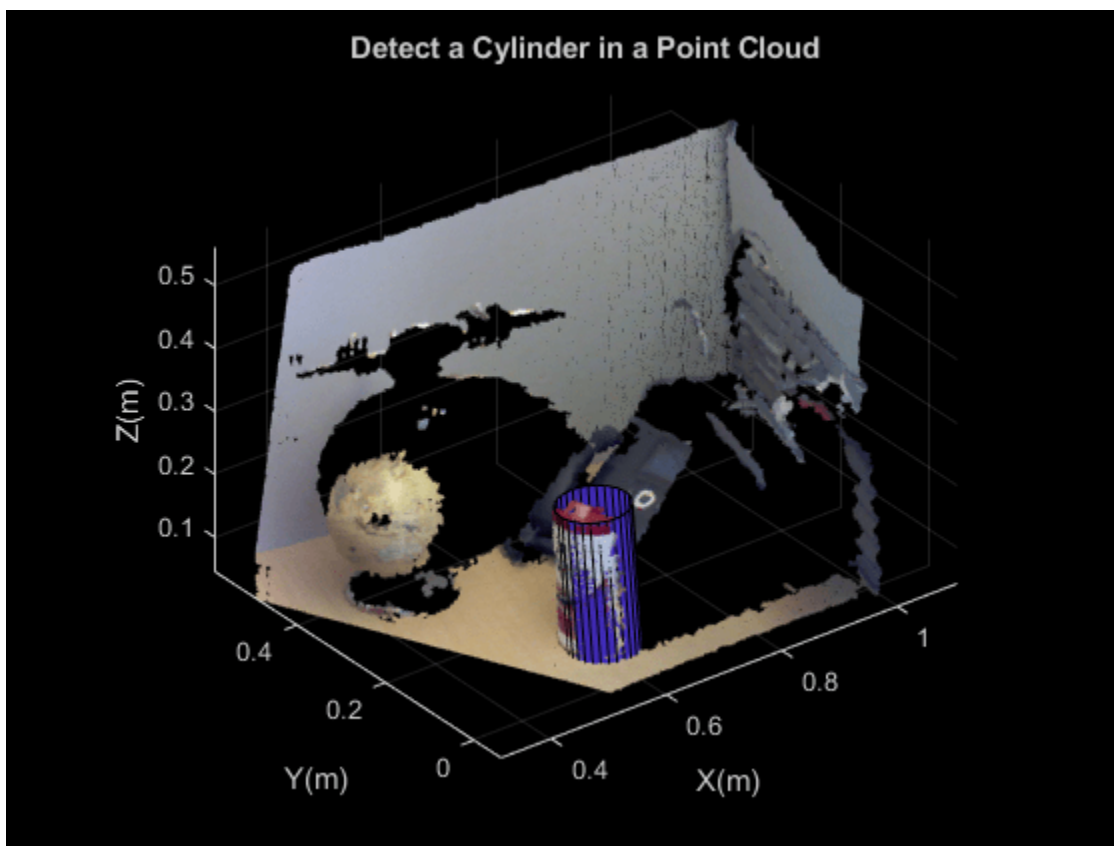

See Also

`pcfitcylinder` | `cylinderModel`

Introduced in R2015b

planeModel

Object for storing a parametric plane model

Description

Construct and store a parametric plane model based on parameters that describe a plane.

Creation

Syntax

```
model = planeModel(Parameters)
```

Description

`model = planeModel(Parameters)` constructs a parametric plane model from the 1-by-4 `Parameters` input vector that describes a plane.

Input Arguments

Parameters — Plane parameters

1-by-4 scalar vector

Plane parameters, specified as a 1-by-4 vector. This input specifies the `Parameters` property. The four parameters $[a,b,c,d]$ describe the equation for a plane:

$$ax + by + cz + d = 0$$

Properties

These properties are read-only.

Parameters — Plane model parameters

1-by-4 vector

Plane model parameters, stored as a 1-by-4 vector. These parameters are specified by the `Parameters` input argument.

Normal — Normal vector of the plane

1-by-3 vector

Normal vector of the plane, stored as a 1-by-3 vector. The $[a,b,c]$ vector specifies the unnormalized normal vector of the plane.

Object Functions

`plot` Plot plane in a figure window
`normalRotation` Compute transform for rotation of a normal to a plane

Examples

Detect Multiple Planes from Point Cloud

Load the point cloud.

```
load('object3d.mat')
```

Display and label the point cloud.

```
figure  
pcshow(ptCloud)  
xlabel('X(m)')  
ylabel('Y(m)')  
zlabel('Z(m)')  
title('Original Point Cloud')
```

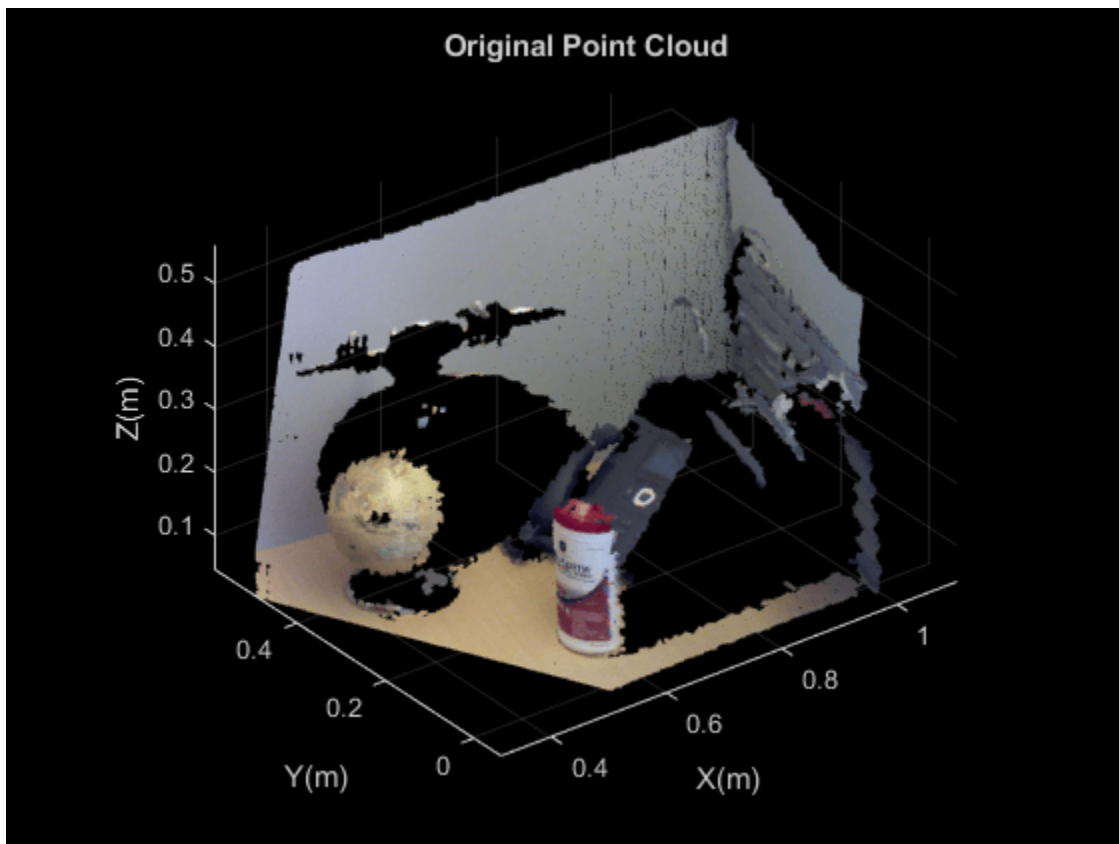

Set the maximum point-to-plane distance (2cm) for plane fitting.

```
maxDistance = 0.02;
```

Set the normal vector of the plane.

```
referenceVector = [0,0,1];
```

Set the maximum angular distance to 5 degrees.

```
maxAngularDistance = 5;
```

Detect the first plane, the table, and extract it from the point cloud.

```
[model1,inlierIndices,outlierIndices] = pcfplane(ptCloud,...
    maxDistance,referenceVector,maxAngularDistance);
plane1 = select(ptCloud,inlierIndices);
remainPtCloud = select(ptCloud,outlierIndices);
```

Set the region of interest to constrain the search for the second plane, left wall.

```
roi = [-inf,inf;0.4,inf;-inf,inf];
sampleIndices = findPointsInROI(remainPtCloud,roi);
```

Detect the left wall and extract it from the remaining point cloud.

```
[model2,inlierIndices,outlierIndices] = pcfplane(remainPtCloud,...
    maxDistance,'SampleIndices',sampleIndices);
plane2 = select(remainPtCloud,inlierIndices);
remainPtCloud = select(remainPtCloud,outlierIndices);
```

Plot the two planes and the remaining points.

```
figure
pcshow(plane1)
title('First Plane')
```

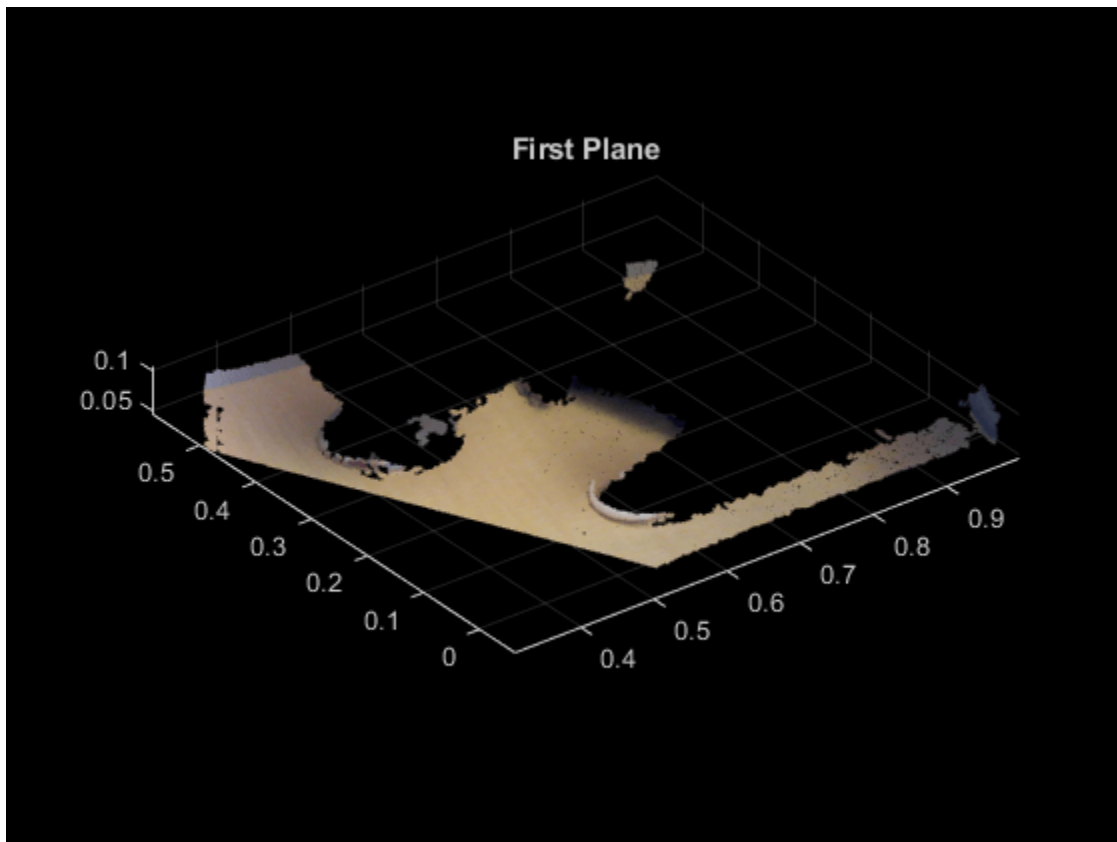

figure

```
pcshow(plane2)  
title('Second Plane')
```

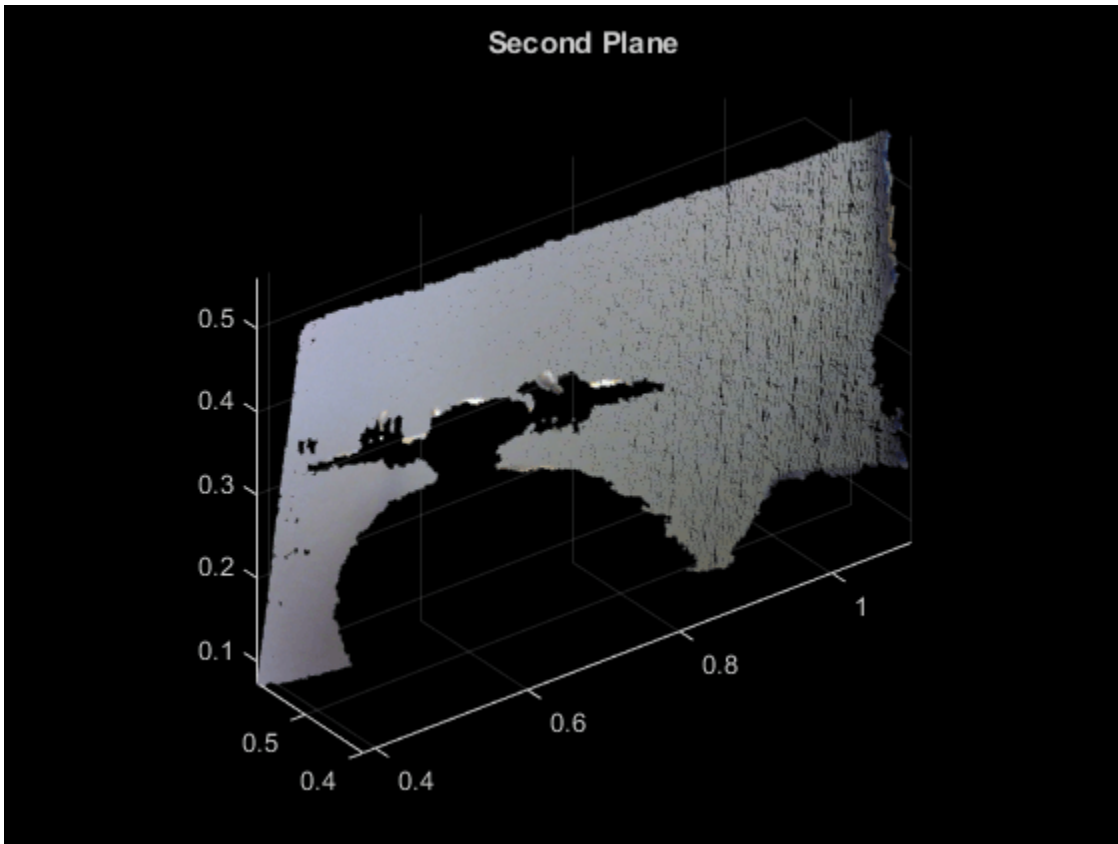

```
figure  
pcshow(remainPtCloud)  
title('Remaining Point Cloud')
```

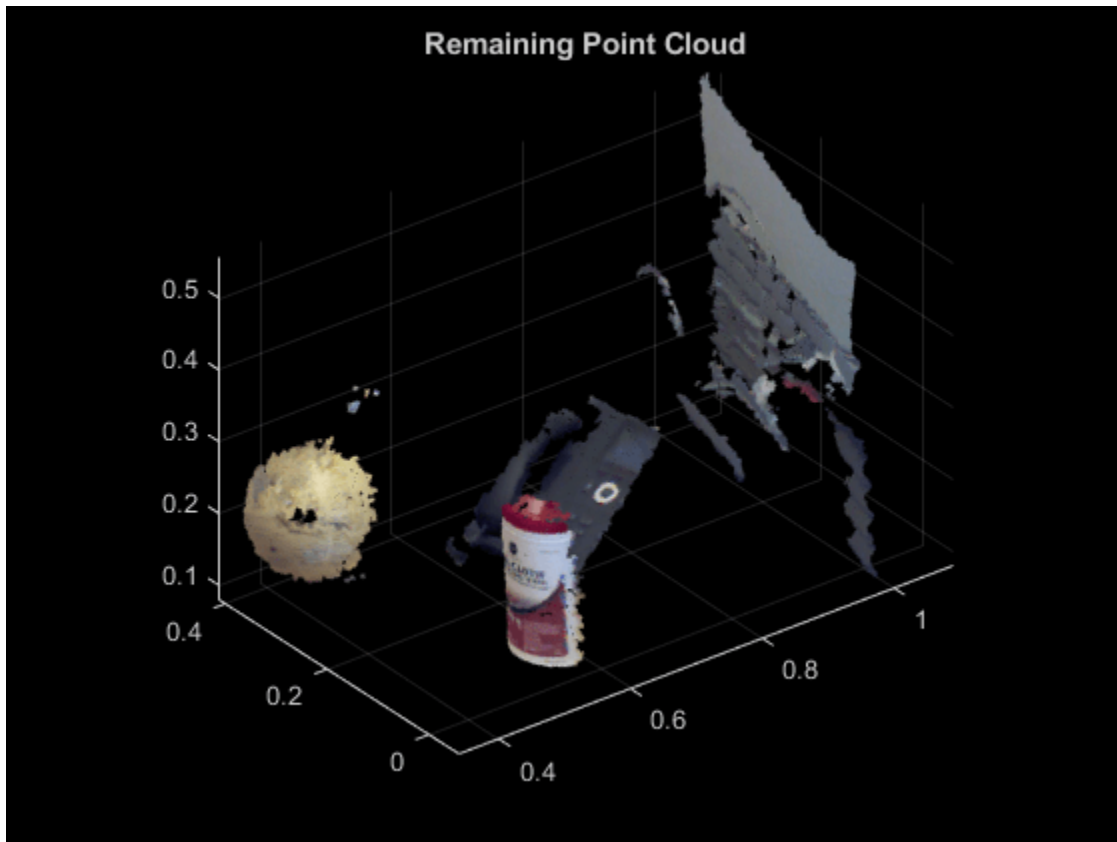

See Also

[pointCloud](#) | [pcfitplane](#) | [pcfitsphere](#) | [pcfitcylinder](#) | [sphereModel](#) | [cylinderModel](#) | [pcshow](#) | [pcplayer](#) | [pcwrite](#) | [pcread](#) | [pcmerge](#) | [pctransform](#) | [pcdownsample](#) | [pcdenoise](#) | [affine3d](#) | [pcregistericp](#)

Topics

“3-D Point Cloud Registration and Stitching”

Introduced in R2015b

plot

Plot plane in a figure window

Syntax

```
plot(model)
plot(model,Name,Value)
```

Description

`H = plot(model)` plots a plane within the axis limits of the current figure. `H` is the handle to the patch.

`H = plot(model,Name,Value)` includes additional options specified by one or more `Name,Value` pair arguments.

Examples

Detect Plane in Point Cloud

Load point cloud.

```
load('object3d.mat');
```

Display the point cloud.

```
figure
pcshow(ptCloud)
xlabel('X(m)')
ylabel('Y(m)')
zlabel('Z(m)')
title('Detect a plane in a point cloud')
```

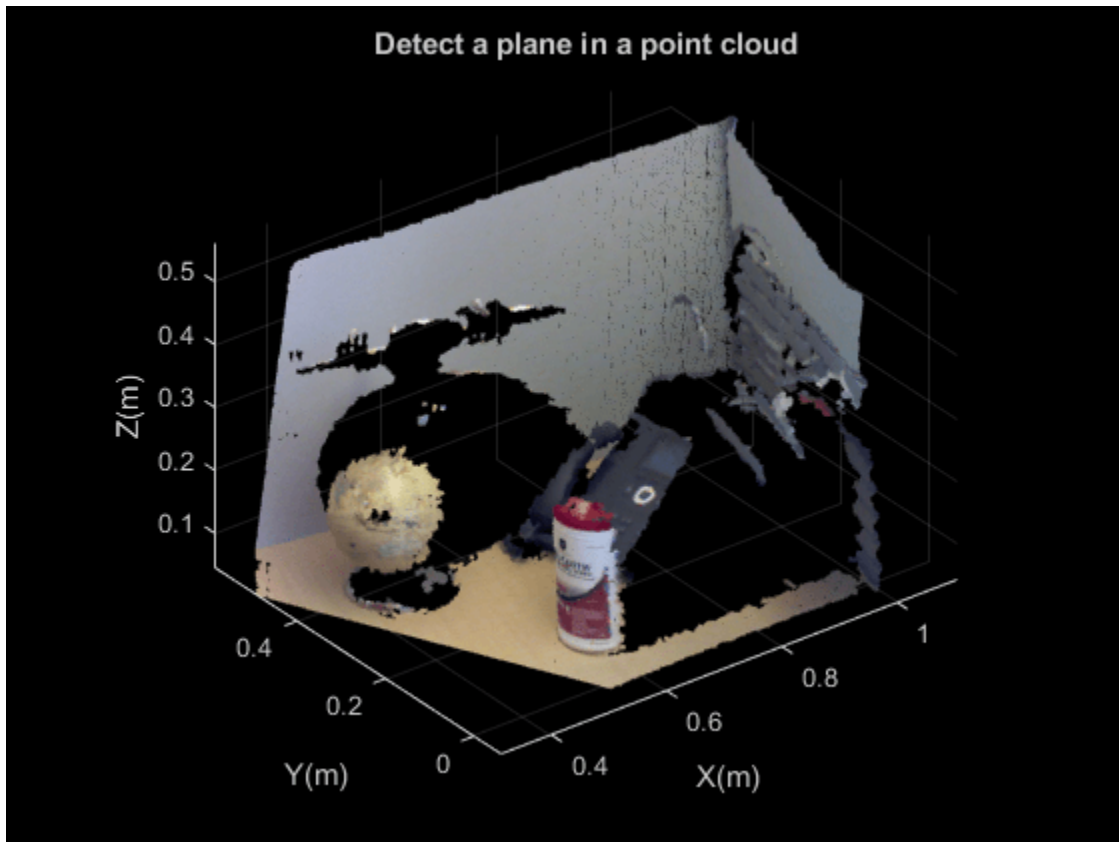
Set the maximum point-to-plane distance (2cm) for plane fitting.

```
maxDistance = 0.02;
```

Set the normal vector of a plane.

```
referenceVector = [0, 0, 1];
```

Set the maximum angular distance (5 degrees).

```
maxAngularDistance = 5;
```

Detect the table in the point cloud and extract it.

```
model = pcfitplane(ptCloud,maxDistance,referenceVector,maxAngularDistance);
```

Plot the plane.

```
hold on  
plot(model)
```

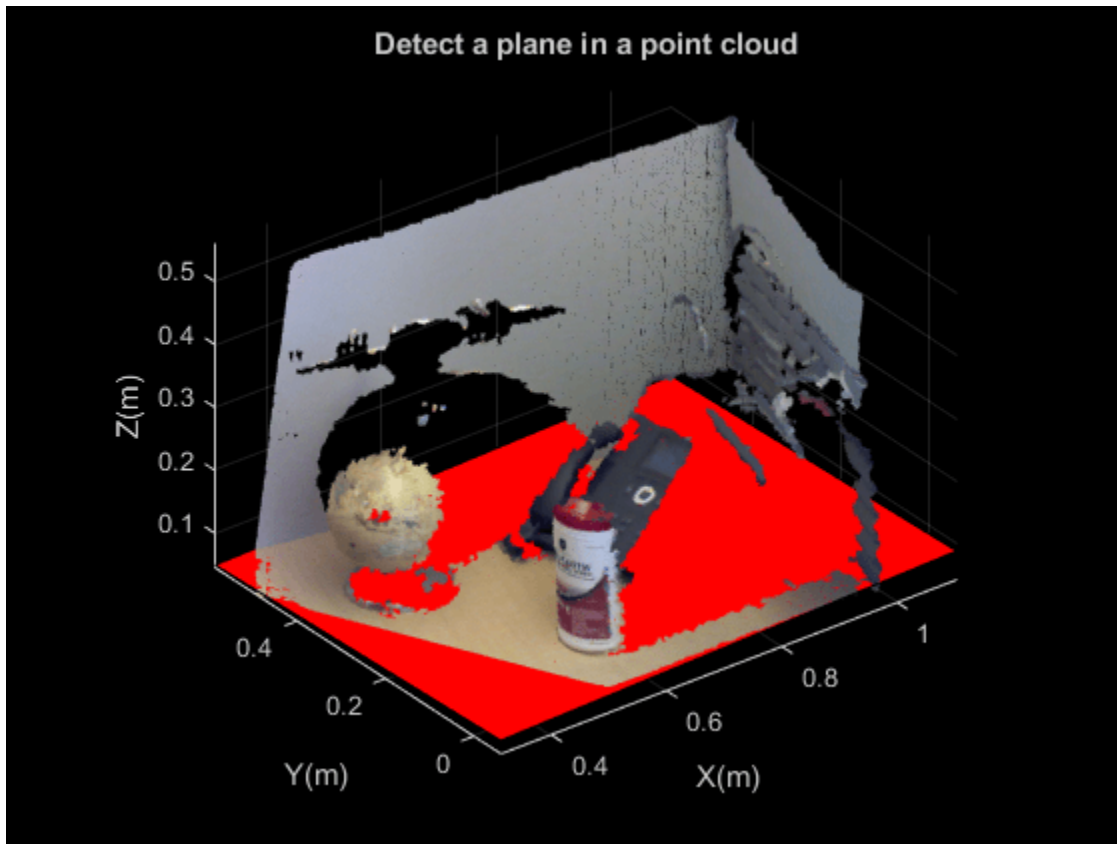

Input Arguments

model — Parametric plane model

plane model

Parametric plane model returned by `planeModel`.

Name-Value Pair Arguments

Specify optional comma-separated pairs of `Name, Value` arguments. `Name` is the argument name and `Value` is the corresponding value. `Name` must appear inside quotes. You can specify several name and value pair arguments in any order as `Name1, Value1, ..., NameN, ValueN`.

Example: `'Color', 'r'`.

Parent — Output axes







`gca` (default) | axes

Output axes, specified as the current axes for displaying the visualization.

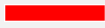
Color — Color of the plane

`'red'` (default) | 1-by-3 RGB vector | short name of color | long name of color

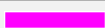
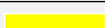
Color of the plane, specified as a 1-by-3 RGB vector or a short or long color name.

Color Name	Short Name	RGB Triplet	Appearance
'red'	'r'	[1 0 0]	
'green'	'g'	[0 1 0]	
'blue'	'b'	[0 0 1]	
'cyan'	'c'	[0 1 1]	
'magenta'	'm'	[1 0 1]	
'yellow'	'y'	[1 1 0]	
'black'	'k'	[0 0 0]	
'white'	'w'	[1 1 1]	

Introduced in R2015b

sphereModel class

Object for storing a parametric sphere model

Syntax

```
model = sphereModel(params)
```

Description

Object for storing a parametric sphere model

Construction

`model = sphereModel(params)` constructs a parametric sphere model from the 1-by-4 `params` input vector that describes a sphere.

Input Arguments

params — Sphere parameters

1-by-4 scalar vector

Sphere parameters, specified as a 1-by-4 scalar vector. This input specifies the `Parameters` property. The four parameters $[a,b,c,d]$ satisfy the equation for a sphere:

$$(x - a)^2 + (y - b)^2 + (z - c)^2 = d^2$$

Properties

These properties are read-only.

Parameters — Sphere model parameters

1-by-4 vector

Sphere model parameters, stored as a 1-by-4 vector. These parameters are specified by the `params` input argument. The four parameters $[a,b,c,d]$ satisfy the equation for a sphere:

$$(x - a)^2 + (y - b)^2 + (z - c)^2 = d^2$$

Center — Center of the sphere

1-by-3 vector

Center of the sphere, stored as a 1-by-3 vector $[xc,yc,zc]$ that specifies the center coordinates of the sphere.

Radius — Radius of sphere

scalar

Radius of sphere, stored as a scalar value.

Methods

sphereModel.plot

Plot sphere in a figure window

Examples

Detect Sphere in Point Cloud

Load point cloud.

```
load('object3d.mat');
```

Display point cloud.

```
figure
pcshow(ptCloud)
xlabel('X(m)')
ylabel('Y(m)')
zlabel('Z(m)')
title('Detect a sphere in a point cloud')
```

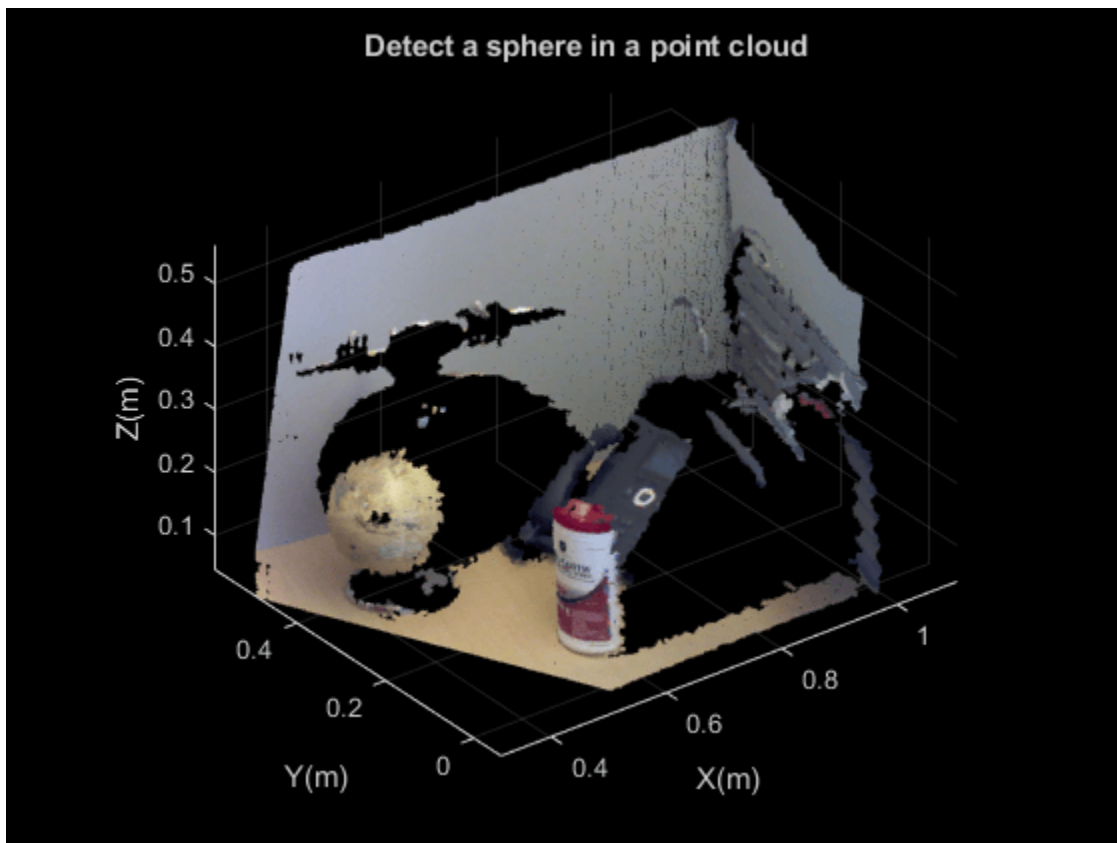

Set the maximum point-to-sphere distance (1cm), for sphere fitting.

```
maxDistance = 0.01;
```

Set the region of interest to constrain the search.

```
roi = [-inf, 0.5; 0.2, 0.4; 0.1, inf];  
sampleIndices = findPointsInROI(ptCloud, roi);
```

Detect the globe in the point cloud and extract it.

```
model = pcfitsphere(ptCloud, maxDistance, 'SampleIndices', sampleIndices);
```

Plot the sphere.

```
hold on  
plot(model)
```

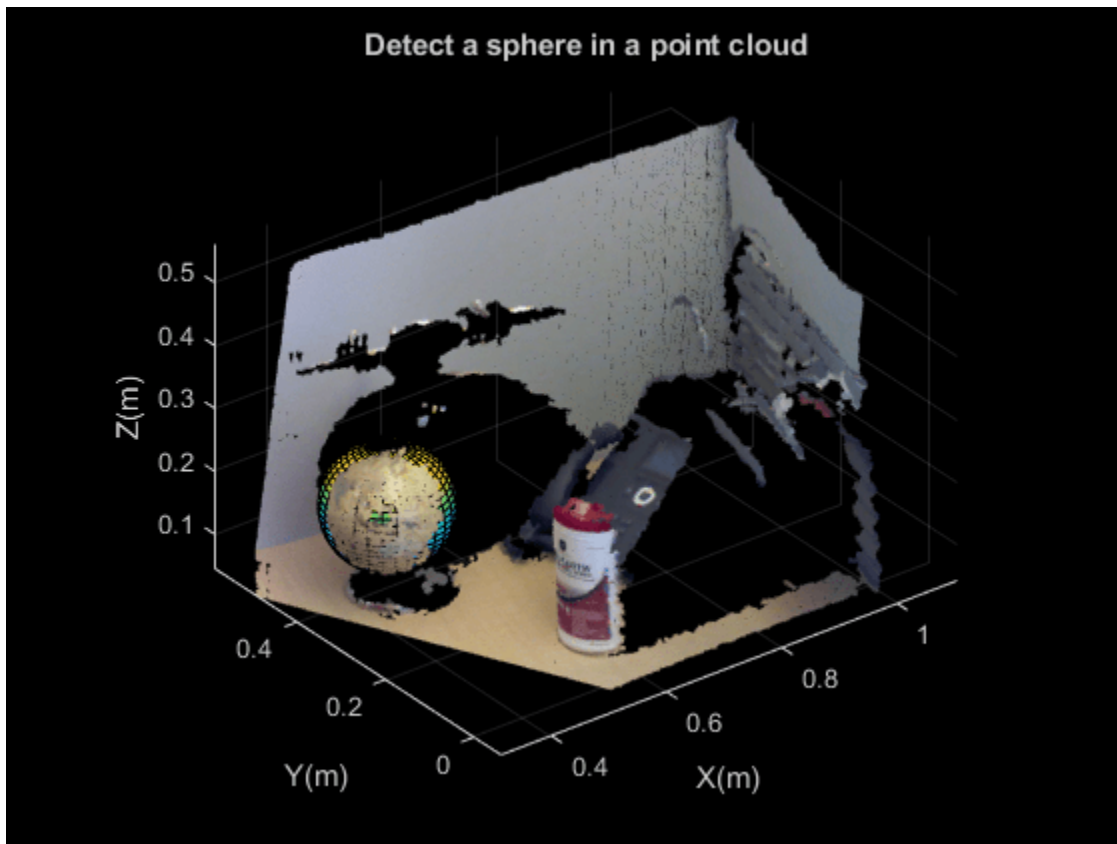

See Also

[pointCloud](#) | [pcfitsphere](#) | [pcfitcylinder](#) | [pcfitplane](#) | [planeModel](#) | [cylinderModel](#) | [pcshow](#) | [pcplayer](#) | [pcwrite](#) | [pcread](#) | [pcmerge](#) | [pctransform](#) | [pcdownsample](#) | [pcdenoise](#) | [affine3d](#) | [pcregistericp](#)

Topics

"3-D Point Cloud Registration and Stitching"

Introduced in R2015b

sphereModel.plot

Plot sphere in a figure window

Syntax

```
plot(model)
plot(model, 'Parent', ax)
```

Description

`H = plot(model)` plots a sphere in the current figure. `H` is the handle to `surf`, a 3-D shaded surface plot.

`H = plot(model, 'Parent', ax)` additionally allows you to specify an output axes.

Input Arguments

model — Parametric sphere model

sphere model

Parametric sphere model returned by `sphereModel`.

'Parent' — Output axes

`gca` (default) | axes

Output axes, specified as the comma-separated pair of `'Parent'` and the current axes for displaying the visualization.

Examples

Detect Sphere in Point Cloud

Load point cloud.

```
load('object3d.mat');
```

Display point cloud.

```
figure
pcshow(ptCloud)
xlabel('X(m)')
ylabel('Y(m)')
zlabel('Z(m)')
title('Detect a sphere in a point cloud')
```

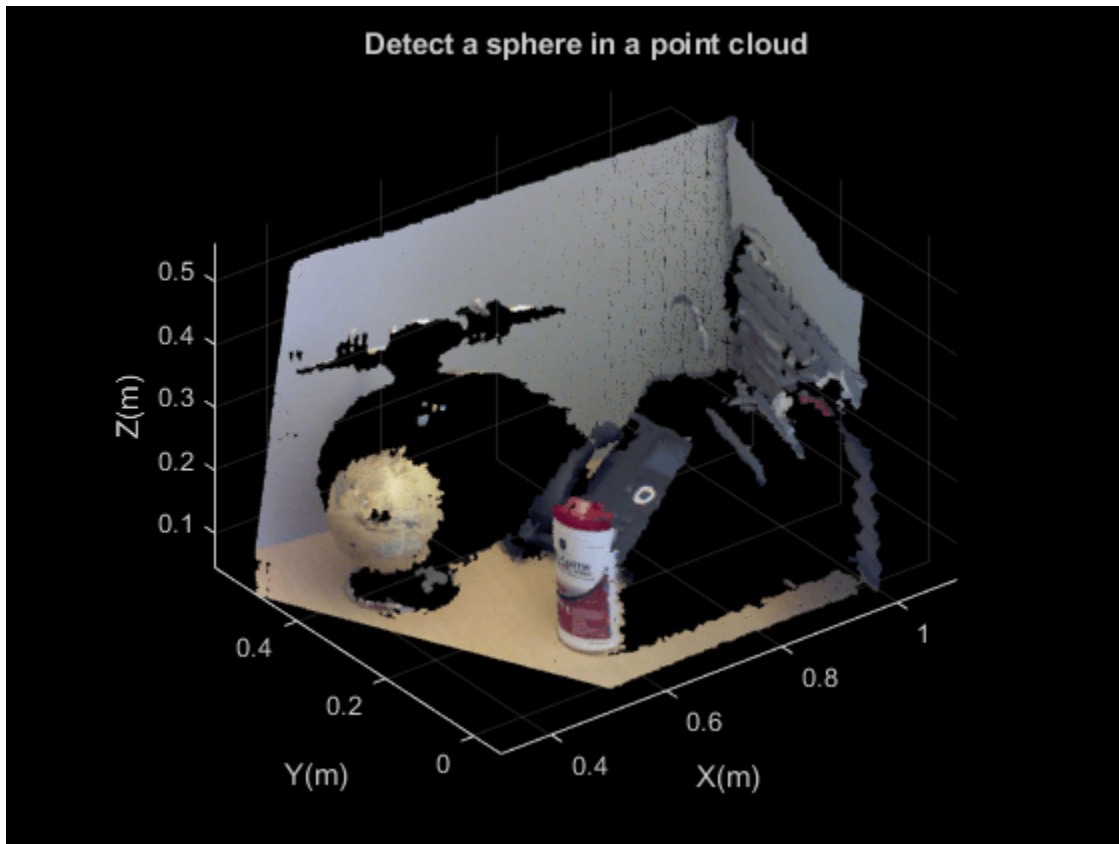

Set the maximum point-to-sphere distance (1cm), for sphere fitting.

```
maxDistance = 0.01;
```

Set the region of interest to constrain the search.

```
roi = [-inf, 0.5; 0.2, 0.4; 0.1, inf];  
sampleIndices = findPointsInROI(ptCloud, roi);
```

Detect the globe in the point cloud and extract it.

```
model = pcfitsphere(ptCloud, maxDistance, 'SampleIndices', sampleIndices);
```

Plot the sphere.

```
hold on  
plot(model)
```

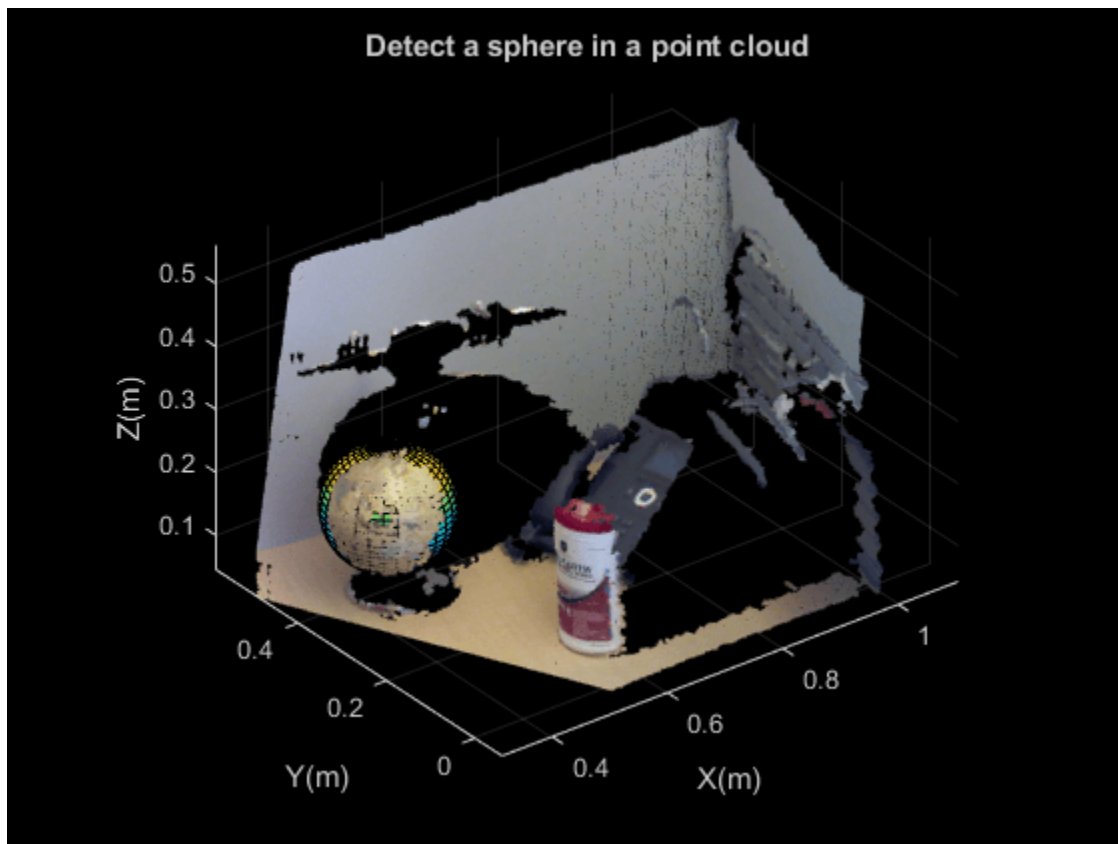
See Also

`pcfitsphere` | `sphereModel`

Introduced in R2015b

opticalFlow

Object for storing optical flow matrices

Description

The `opticalFlow` object stores the direction and speed of a moving object from one image or video frame to another. Use the object function `plot` to plot the optical flow vectors.

Creation

Syntax

```
flow = opticalFlow  
flow = opticalFlow(Vx,Vy)
```

Description

`flow = opticalFlow` creates an optical flow object with default property values.

`flow = opticalFlow(Vx,Vy)` creates an optical flow object from two equal-sized matrices `Vx` and `Vy`. The matrices `Vx` and `Vy` are the *x* and *y* components of velocity respectively. The input velocity components set the “Properties” on page 2-654 of optical flow object.

Input Arguments

Vx — x component of velocity

M-by-*N* matrix

x component of velocity, specified as an *M*-by-*N* matrix.

Data Types: `single` | `double`

Vy — y component of velocity

M-by-*N* matrix

y component of velocity, specified as an *M*-by-*N* matrix.

Data Types: `single` | `double`

Note `Vx` and `Vy` must be of the same size and data type.

Properties

Vx — x component of velocity

0-by-1 empty matrix (default) | *M*-by-*N* matrix

x component of velocity, specified as an *M*-by-*N* matrix. If the input `Vx` is not specified, the default value of this property is set to 0-by-1 empty matrix.

Data Types: `single` | `double`

Vy — y component of velocity

0-by-1 empty matrix (default) | *M*-by-*N* matrix

y component of velocity, specified as an *M*-by-*N* matrix. If the input *Vy* is not specified, the default value of this property is set to 0-by-1 empty matrix.

Data Types: `single` | `double`

Orientation — Phase angles of optical flow

0-by-1 empty matrix (default) | *M*-by-*N* matrix

This property is read-only.

Phase angles of optical flow in radians, specified as an *M*-by-*N* matrix of the same size and data type as the components of velocity. The phase angles of optical flow is calculated from the *x* and *y* components of velocity. If the inputs *Vx* and *Vy* are not specified, the default value of this property is set to 0-by-1 empty matrix.

Data Types: `single` | `double`

Magnitude — Magnitude of optical flow

0-by-1 empty matrix (default) | *M*-by-*N* matrix

This property is read-only.

Magnitude of optical flow, specified as an *M*-by-*N* matrix of the same size and data type as the components of velocity. The magnitude of optical flow is calculated from the *x* and *y* components of velocity. If the inputs *Vx* and *Vy* are not specified, the default value of this property is set to 0-by-1 empty matrix.

Data Types: `single` | `double`

Object Functions

`plot` Plot optical flow vectors

Examples

Create Optical Flow Object

Create an optical flow object and view its properties.

```
flow = opticalFlow
```

```
flow =
```

```
    opticalFlow with properties:
```

```
        Vx: [0×1 double]
        Vy: [0×1 double]
    Orientation: [0×1 double]
        Magnitude: [0×1 double]
```

The default values of the properties are returned as an empty matrix of size 0-by-1 and data type double.

Create an Optical Flow Object and Plot Its Velocity

Create an optical flow object from two equal-sized velocity matrices.

```
Vx = randn(100,100);  
Vy = randn(100,100);  
opflow = opticalFlow(Vx,Vy);
```

Inspect the properties of the optical flow object. The orientation and the magnitude are computed from the velocity matrices.

```
opflow  
  
opflow =  
  opticalFlow with properties:  
  
          Vx: [100x100 double]  
          Vy: [100x100 double]  
  Orientation: [100x100 double]  
  Magnitude: [100x100 double]
```

Plot the velocity of the object as a quiver plot.

```
plot(opflow, 'DecimationFactor', [10 10], 'ScaleFactor', 10);
```

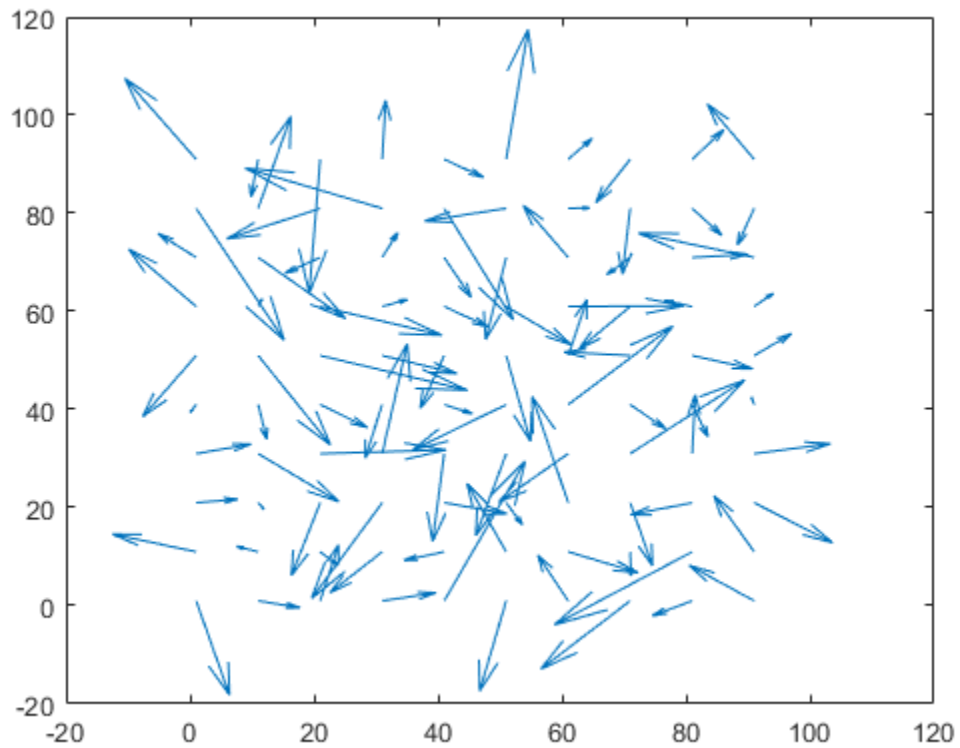

Extended Capabilities

C/C++ Code Generation

Generate C and C++ code using MATLAB® Coder™.

See Also

[quiver](#) | [opticalFlowHS](#) | [opticalFlowLKDoG](#) | [opticalFlowLK](#) | [opticalFlowFarneback](#)

Introduced in R2015a

plot

Plot optical flow vectors

Syntax

```
plot(flow)
plot(flow,Name,Value)
```

Description

`plot(flow)` plots the optical flow vectors.

`plot(flow,Name,Value)` specifies options using one or more name-value arguments in addition to the input argument in the previous syntax.

Examples

Create an Optical Flow Object and Plot Its Velocity

Create an optical flow object from two equal-sized velocity matrices.

```
Vx = randn(100,100);
Vy = randn(100,100);
opflow = opticalFlow(Vx,Vy);
```

Inspect the properties of the optical flow object. The orientation and the magnitude are computed from the velocity matrices.

```
opflow
```

```
opflow =
  opticalFlow with properties:
      Vx: [100x100 double]
      Vy: [100x100 double]
  Orientation: [100x100 double]
  Magnitude: [100x100 double]
```

Plot the velocity of the object as a quiver plot.

```
plot(opflow,'DecimationFactor',[10 10],'ScaleFactor',10);
```

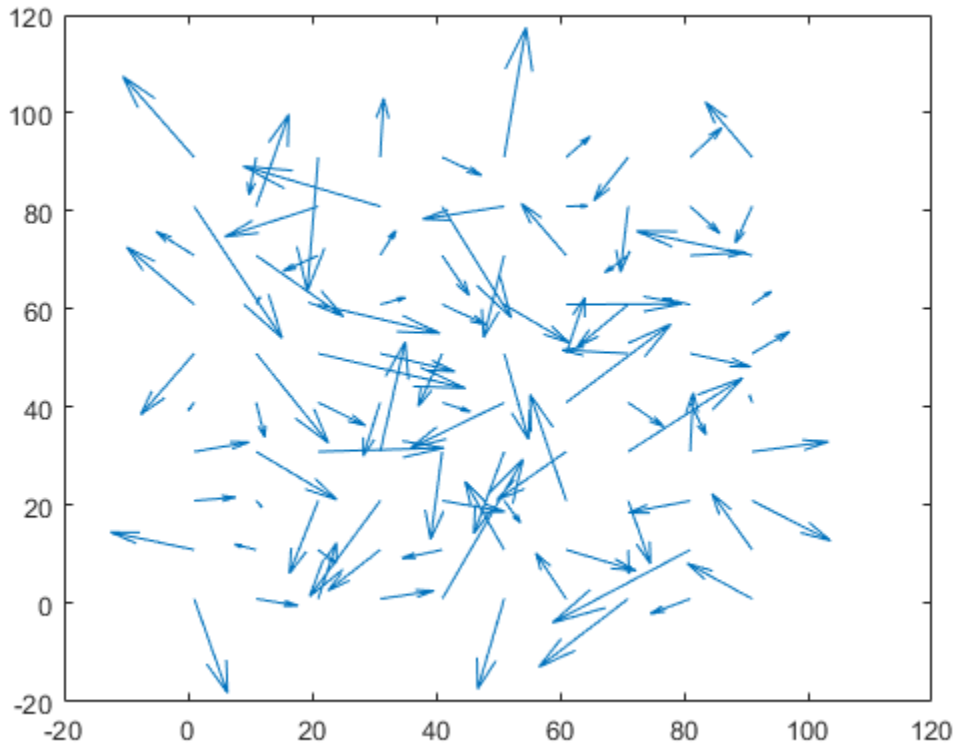

Input Arguments

flow — Object containing optical flow matrices

opticalFlow object

Object containing optical flow velocity matrices, specified as an `opticalFlow` object.

Name-Value Pair Arguments

Specify optional comma-separated pairs of `Name`, `Value` arguments. `Name` is the argument name and `Value` is the corresponding value. `Name` must appear inside quotes. You can specify several name and value pair arguments in any order as `Name1`, `Value1`, ..., `NameN`, `ValueN`.

Example: `plot(flow, 'DecimationFactor', [1 1])`

DecimationFactor — Decimation factor of velocity vectors

[1 1] (default) | two-element vector

Decimation factor of velocity vectors, specified as the comma-separated pair consisting of 'DecimationFactor' and a two-element vector. The two-element vector is of form `[XDecimFactor YDecimFactor]` and specifies the decimation factor for velocity vectors along the *x* and *y* directions respectively. `XDecimFactor` and `YDecimFactor` are positive scalar integers. Increase the value of this property to get a less cluttered quiver plot.

ScaleFactor — Scaling factor for velocity vector display

1 (default) | positive integer-valued scalar

Scaling factor for velocity vector display, specified as the comma-separated pair consisting of 'ScaleFactor' and a positive integer-valued scalar. Increase this value to display longer vectors.

Parent — Figure axes

gca handle

Figure axes, specified as the comma-separated pair consisting of 'Parent' and axes object. The default is set to the current axes handle, `gca`.

See Also

`quiver` | `opticalFlow`

Introduced in R2015a

opticalFlowHS

Object for estimating optical flow using Horn-Schunck method

Description

Create an optical flow object for estimating the direction and speed of a moving object using the Horn-Schunck method. Use the object function `estimateFlow` to estimate the optical flow vectors. Using the `reset` object function, you can reset the internal state of the optical flow object.

Creation

Syntax

```
opticFlow = opticalFlowHS  
opticFlow = opticalFlowHS(Name, Value)
```

Description

`opticFlow = opticalFlowHS` returns an optical flow object that you can use to estimate the direction and speed of the moving objects in a video. The optical flow is estimated using the Horn-Schunck method.

`opticFlow = opticalFlowHS(Name, Value)` returns an optical flow object with properties specified as one or more `Name, Value` pair arguments. Any unspecified properties have default values. Enclose each property name in quotes.

For example, `opticalFlowHS('Smoothness', 1.5)`

Properties

Smoothness — Expected smoothness

1 (default) | positive scalar

Expected smoothness of optical flow, specified as a positive scalar. Increase this value when there is increased motion between consecutive frames. A typical value for 'Smoothness' is around 1.

MaxIteration — Maximum number of iterations

10 (default) | positive integer-valued scalar

Maximum number of iterations, specified as a positive integer-valued scalar. Increase this value to estimate the optical flow of objects with low velocity.

The iterative computation stops when the number of iterations equals the value of 'MaxIteration' or when the algorithm reaches the value set for 'VelocityDifference'. To stop computation only by using 'MaxIteration', set the value of 'VelocityDifference' to 0.

VelocityDifference — Minimum absolute velocity difference

0 (default) | positive scalar

Minimum absolute velocity difference, specified as a positive scalar. This value depends on the input data type. Decrease this value to estimate the optical flow of objects that have low velocity.

The iterative computation stops when the algorithm reaches the value set for 'VelocityDifference' or the number of iterations equals 'MaxIteration'. To use only 'VelocityDifference' to stop computation, set 'MaxIteration' to Inf.

Object Functions

`estimateFlow` Estimate optical flow
`reset` Reset the internal state of the optical flow estimation object

Examples

Estimate Optical Flow Using Horn-Schunck Method

Create a `VideoReader` object for the input video file, `visiontraffic.avi`. Specify the timestamp of the frame to read as 11.

```
vidReader = VideoReader('visiontraffic.avi','CurrentTime',11);
```

Specify the optical flow estimation method as `opticalFlowHS`. The output is an object specifying the optical flow estimation method and its properties.

```
opticFlow = opticalFlowHS

opticFlow =
  opticalFlowHS with properties:
      Smoothness: 1
    MaxIteration: 10
  VelocityDifference: 0
```

Create a custom figure window to visualize the optical flow vectors.

```
h = figure;
movegui(h);
hViewPanel = uipanel(h,'Position',[0 0 1 1],'Title','Plot of Optical Flow Vectors');
hPlot = axes(hViewPanel);
```

Read image frames from the `VideoReader` object and convert to grayscale images. Estimate the optical flow from consecutive image frames. Display the current image frame and plot the optical flow vectors as quiver plot.

```
while hasFrame(vidReader)
    frameRGB = readFrame(vidReader);
    frameGray = im2gray(frameRGB);
    flow = estimateFlow(opticFlow,frameGray);
    imshow(frameRGB)
    hold on
    plot(flow,'DecimationFactor',[5 5],'ScaleFactor',60,'Parent',hPlot);
    hold off
    pause(10^-3)
end
```

Plot of Optical Flow Vectors

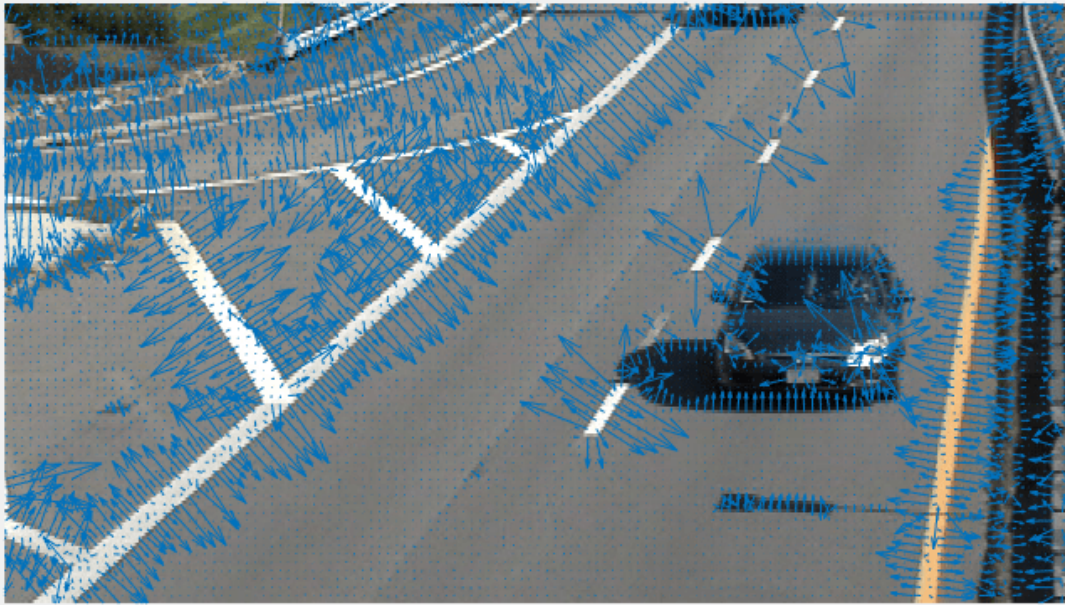

Plot of Optical Flow Vectors

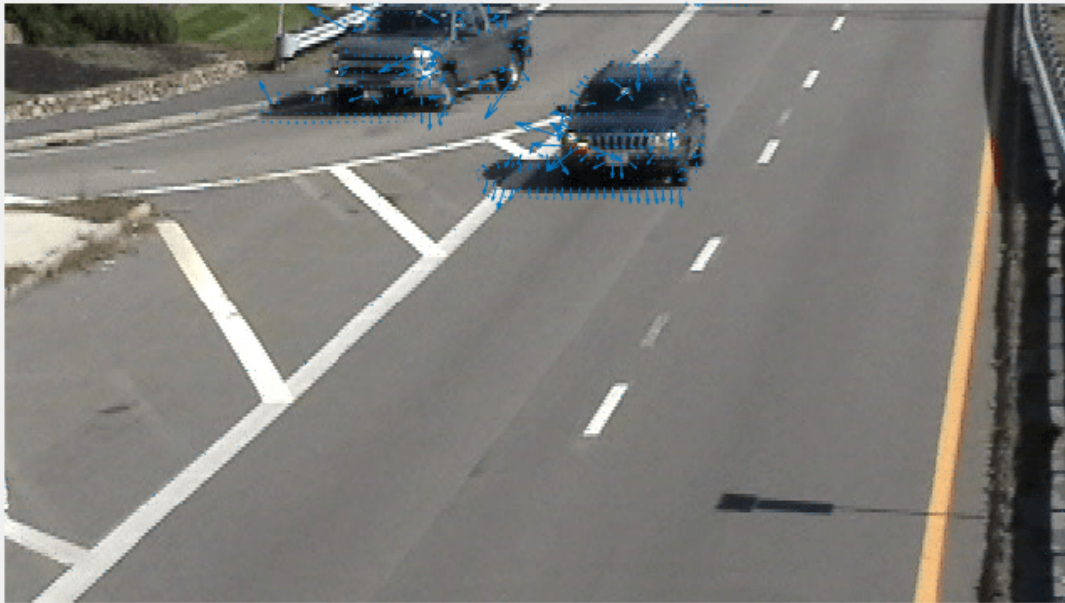

Algorithms

To compute the optical flow between two images, you must solve this optical flow constraint equation:

$$I_x u + I_y v + I_t = 0$$

.

- I_x , I_y , and I_t are the spatiotemporal image brightness derivatives.
- u is the horizontal optical flow.
- v is the vertical optical flow.

Horn-Schunck Method

By assuming that the optical flow is smooth across the entire image, the Horn-Schunck method estimates a velocity field, $[u \ v]^T$, that minimizes this equation:

$$E = \iint (I_x u + I_y v + I_t)^2 dx dy + \alpha \iint \left\{ \left(\frac{\partial u}{\partial x} \right)^2 + \left(\frac{\partial u}{\partial y} \right)^2 + \left(\frac{\partial v}{\partial x} \right)^2 + \left(\frac{\partial v}{\partial y} \right)^2 \right\} dx dy$$

.

In this equation, $\frac{\partial u}{\partial x}$ and $\frac{\partial u}{\partial y}$ are the spatial derivatives of the optical velocity component, u , and α scales the global smoothness term. The Horn-Schunck method minimizes the previous equation to obtain the velocity field, $[u \ v]$, for each pixel in the image. This method is given by the following equations:

$$u_{x,y}^{k+1} = \bar{u}_{x,y}^k - \frac{I_x [I_x \bar{u}_{x,y}^k + I_y \bar{v}_{x,y}^k + I_t]}{\alpha^2 + I_x^2 + I_y^2}$$

$$v_{x,y}^{k+1} = \bar{v}_{x,y}^k - \frac{I_y [I_x \bar{u}_{x,y}^k + I_y \bar{v}_{x,y}^k + I_t]}{\alpha^2 + I_x^2 + I_y^2}$$

.

In these equations, $[u_{x,y}^k \ v_{x,y}^k]$ is the velocity estimate for the pixel at (x,y) , and $[\bar{u}_{x,y}^k \ \bar{v}_{x,y}^k]$ is the neighborhood average of $[u_{x,y}^k \ v_{x,y}^k]$. For $k = 0$, the initial velocity is 0.

To solve u and v using the Horn-Schunck method:

- 1 Compute I_x and I_y by using the Sobel convolution kernel, $[-1 \ -2 \ -1; 0 \ 0 \ 0; 1 \ 2 \ 1]$, and its transposed form for each pixel in the first image.
- 2 Compute I_t between images 1 and 2 using the $[-1 \ 1]$ kernel.
- 3 Assume the previous velocity to be 0, and compute the average velocity for each pixel using $[0 \ 1 \ 0; 1 \ 0 \ 1; 0 \ 1 \ 0]$ as a convolution kernel.
- 4 Iteratively solve for u and v .

References

- [1] Barron, J. L., D. J. Fleet, S. S. Beauchemin, and T. A. Burkitt. "Performance of optical flow techniques." In *Proceedings of the IEEE Conference on Computer Vision and Pattern Recognition (CVPR)*, 236-242. Champaign, IL: CVPR, 1992.

Extended Capabilities

C/C++ Code Generation

Generate C and C++ code using MATLAB® Coder™.

See Also

[quiver](#) | [opticalFlow](#) | [opticalFlowLKDoG](#) | [opticalFlowLK](#) | [opticalFlowFarneback](#)

Introduced in R2015a

opticalFlowLK

Object for estimating optical flow using Lucas-Kanade method

Description

Create an optical flow object for estimating the direction and speed of a moving object using the Lucas-Kanade method. Use the object function `estimateFlow` to estimate the optical flow vectors. Using the `reset` object function, you can reset the internal state of the optical flow object.

Creation

Syntax

```
opticFlow = opticalFlowLK  
opticFlow = opticalFlowLK('NoiseThreshold', threshold)
```

Description

`opticFlow = opticalFlowLK` returns an optical flow object that you can use to estimate the direction and speed of the moving objects in a video. The optical flow is estimated using the Lucas-Kanade method.

`opticFlow = opticalFlowLK('NoiseThreshold', threshold)` returns an optical flow object with the property 'NoiseThreshold' specified as a Name, Value pair. Enclose the property name in quotes.

For example, `opticalFlowLK('NoiseThreshold', 0.05)`

Properties

threshold — Threshold for noise reduction

0.0039 (default) | positive scalar

Threshold for noise reduction, specified as a positive scalar. As you increase this number, the movement of the objects has less impact on optical flow calculation.

Object Functions

<code>estimateFlow</code>	Estimate optical flow
<code>reset</code>	Reset the internal state of the optical flow estimation object

Examples

Compute Optical Flow Using Lucas-Kanade Algorithm

Read a video file. Specify the timestamp of the frame to be read.

```
vidReader = VideoReader('visiontraffic.avi','CurrentTime',11);
```

Create an optical flow object for estimating the optical flow using Lucas-Kanade method. Specify the threshold for noise reduction. The output is an optical flow object specifying the optical flow estimation method and its properties.

```
opticFlow = opticalFlowLK('NoiseThreshold',0.009);
```

Create a custom figure window to visualize the optical flow vectors.

```
h = figure;
movegui(h);
hViewPanel = uipanel(h,'Position',[0 0 1 1],'Title','Plot of Optical Flow Vectors');
hPlot = axes(hViewPanel);
```

Read the image frames and convert to grayscale images. Estimate the optical flow from consecutive image frames. Display the current image frame and plot the optical flow vectors as quiver plot.

```
while hasFrame(vidReader)
    frameRGB = readFrame(vidReader);
    frameGray = im2gray(frameRGB);
    flow = estimateFlow(opticFlow,frameGray);
    imshow(frameRGB)
    hold on
    plot(flow,'DecimationFactor',[5 5],'ScaleFactor',10,'Parent',hPlot);
    hold off
    pause(10^-3)
end
```

Plot of Optical Flow Vectors

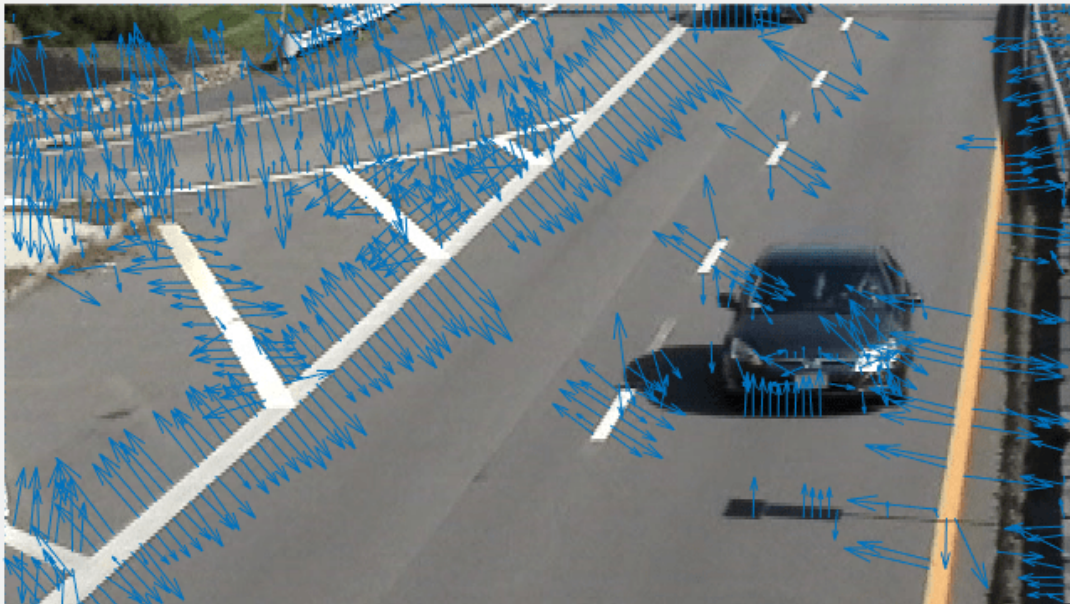

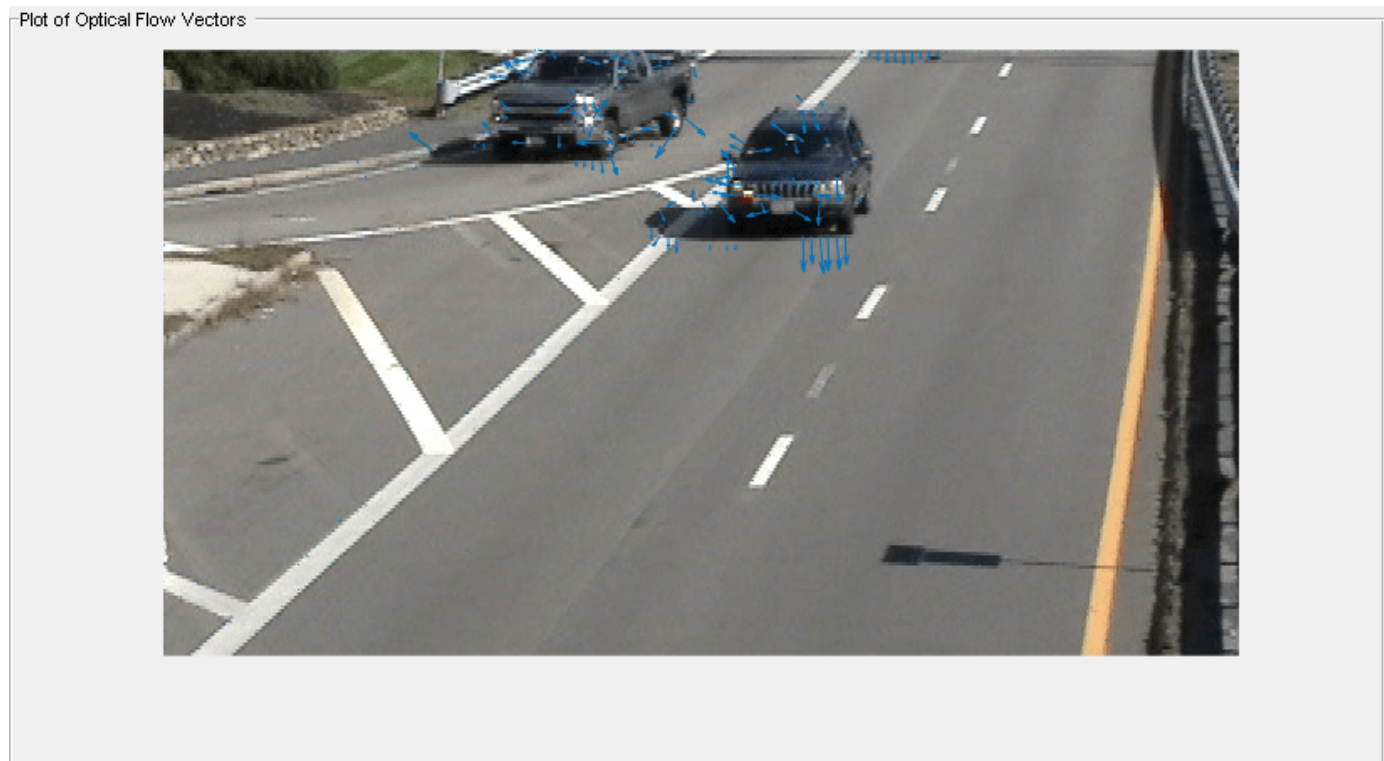

Algorithms

To compute the optical flow between two images, you must solve this optical flow constraint equation:

$$I_x u + I_y v + I_t = 0$$

.

- I_x , I_y , and I_t are the spatiotemporal image brightness derivatives.
- u is the horizontal optical flow.
- v is the vertical optical flow.

Lucas-Kanade Method

To solve the optical flow constraint equation for u and v , the Lucas-Kanade method divides the original image into smaller sections and assumes a constant velocity in each section. Then it performs a weighted, least-square fit of the optical flow constraint equation to a constant model for $[u \ v]^T$ in each section Ω . The method achieves this fit by minimizing this equation:

$$\sum_{x \in \Omega} W^2 [I_x u + I_y v + I_t]^2$$

W is a window function that emphasizes the constraints at the center of each section. The solution to the minimization problem is

$$\begin{bmatrix} \sum W^2 I_x^2 & \sum W^2 I_x I_y \\ \sum W^2 I_y I_x & \sum W^2 I_y^2 \end{bmatrix} \begin{bmatrix} u \\ v \end{bmatrix} = - \begin{bmatrix} \sum W^2 I_x I_t \\ \sum W^2 I_y I_t \end{bmatrix}$$

The Lucas-Kanade method computes I_t using a difference filter, $[-1 \ 1]$.

u and v are solved as follows:

- 1 Compute I_x and I_y using the kernel $[-1 \ 8 \ 0 \ -8 \ 1]/12$ and its transposed form.
- 2 Compute I_t between images 1 and 2 using the $[-1 \ 1]$ kernel.
- 3 Smooth the gradient components, I_x , I_y , and I_t , using a separable and isotropic 5-by-5 element kernel whose effective 1-D coefficients are $[1 \ 4 \ 6 \ 4 \ 1]/16$.
- 4 Solve the 2-by-2 linear equations for each pixel using the following method:

- If $A = \begin{bmatrix} a & b \\ b & c \end{bmatrix} = \begin{bmatrix} \sum W^2 I_x^2 & \sum W^2 I_x I_y \\ \sum W^2 I_y I_x & \sum W^2 I_y^2 \end{bmatrix}$

Then the eigenvalues of A are $\lambda_i = \frac{a+c}{2} \pm \frac{\sqrt{4b^2 + (a-c)^2}}{2}; i = 1, 2$

- The eigenvalues are compared to the threshold, τ , that corresponds to the value you enter for the threshold for noise reduction. The results fall into one of the following cases:

Case 1: $\lambda_1 \geq \tau$ and $\lambda_2 \geq \tau$

A is nonsingular, the system of equations are solved using Cramer's rule.

Case 2: $\lambda_1 \geq \tau$ and $\lambda_2 < \tau$

A is singular (noninvertible), the gradient flow is normalized to calculate u and v .

Case 3: $\lambda_1 < \tau$ and $\lambda_2 < \tau$

The optical flow, u and v , is 0.

References

- [1] Barron, J. L., D. J. Fleet, S. S. Beauchemin, and T. A. Burkitt. "Performance of optical flow techniques." In *Proceedings of the IEEE Conference on Computer Vision and Pattern Recognition (CVPR)*, 236-242. Champaign, IL: CVPR, 1992.

Extended Capabilities

C/C++ Code Generation

Generate C and C++ code using MATLAB® Coder™.

See Also

quiver | opticalFlow | opticalFlowHS | opticalFlowFarneback | opticalFlowLKDoG

Introduced in R2015a

opticalFlowLKDoG

Object for estimating optical flow using Lucas-Kanade derivative of Gaussian method

Description

Create an optical flow object for estimating the direction and speed of moving objects using the Lucas-Kanade derivative of Gaussian (DoG) method. Use the object function `estimateFlow` to estimate the optical flow vectors. Using the `reset` object function, you can reset the internal state of the optical flow object.

Creation

Syntax

```
opticFlow = opticalFlowLKDoG
opticFlow = opticalFlowLKDoG(Name, Value)
```

Description

`opticFlow = opticalFlowLKDoG` returns an optical flow object that you can use to estimate the direction and speed of the moving objects in a video. The optical flow is estimated using the Lucas-Kanade derivative of Gaussian (DoG) method.

`opticFlow = opticalFlowLKDoG(Name, Value)` returns an optical flow object with properties specified as one or more `Name, Value` pair arguments. Any unspecified properties have default values. Enclose each property name in quotes.

For example, `opticalFlowLKDoG('NumFrames', 3)`

Properties

NumFrames — Number of buffered frames

3 (default) | positive integer-valued scalar

Number of buffered frames for temporal smoothing, specified as a positive integer-valued scalar. As you increase this number, the optical flow estimation method becomes less robust to abrupt changes in the trajectory of the moving objects. The amount of delay in flow estimation depends on the value of `NumFrames`. The output flow corresponds to the image at $t_{flow} = t_{current} - 0.5(NumFrames-1)$, where $t_{current}$ is the time of the current image.

ImageFilterSigma — Standard deviation for image smoothing filter

1.5 | positive scalar

Standard deviation for image smoothing filter, specified as a positive scalar.

GradientFilterSigma — Standard deviation for gradient smoothing filter

1 | positive scalar

Standard deviation for gradient smoothing filter, specified as a positive scalar.

NoiseThreshold — Threshold for noise reduction

0.0039 (default) | positive scalar

Threshold for noise reduction, specified as a positive scalar. As you increase this number, the movement of the objects has less impact on optical flow calculation.

Object Functions

estimateFlow Estimate optical flow

reset Reset the internal state of the optical flow estimation object

Examples

Compute Optical Flow Using Lucas-Kanade DoG Method

Read a video file. Specify the timestamp of the frame to be read.

```
vidReader = VideoReader('visiontraffic.avi','CurrentTime',11);
```

Create an optical flow object for estimating the optical flow using Lucas-Kanade DoG method. Specify the threshold for noise reduction. The output is an optical flow object specifying the optical flow estimation method and its properties.

```
opticFlow = opticalFlowLKDoG('NoiseThreshold',0.0005)
```

```
opticFlow =  
    opticalFlowLKDoG with properties:
```

```
        NumFrames: 3  
    ImageFilterSigma: 1.5000  
    GradientFilterSigma: 1  
    NoiseThreshold: 5.0000e-04
```

Create a custom figure window to visualize the optical flow vectors.

```
h = figure;  
movegui(h);  
hViewPanel = uipanel(h,'Position',[0 0 1 1],'Title','Plot of Optical Flow Vectors');  
hPlot = axes(hViewPanel);
```

Read the image frames and convert to grayscale images. Estimate the optical flow from consecutive image frames. Display the current image frame and plot the optical flow vectors as quiver plot.

```
while hasFrame(vidReader)  
    frameRGB = readFrame(vidReader);  
    frameGray = im2gray(frameRGB);  
    flow = estimateFlow(opticFlow,frameGray);  
    imshow(frameRGB)  
    hold on  
    plot(flow,'DecimationFactor',[5 5],'ScaleFactor',35,'Parent',hPlot);  
    hold off  
    pause(10^-3)  
end
```

Plot of Optical Flow Vectors



Plot of Optical Flow Vectors

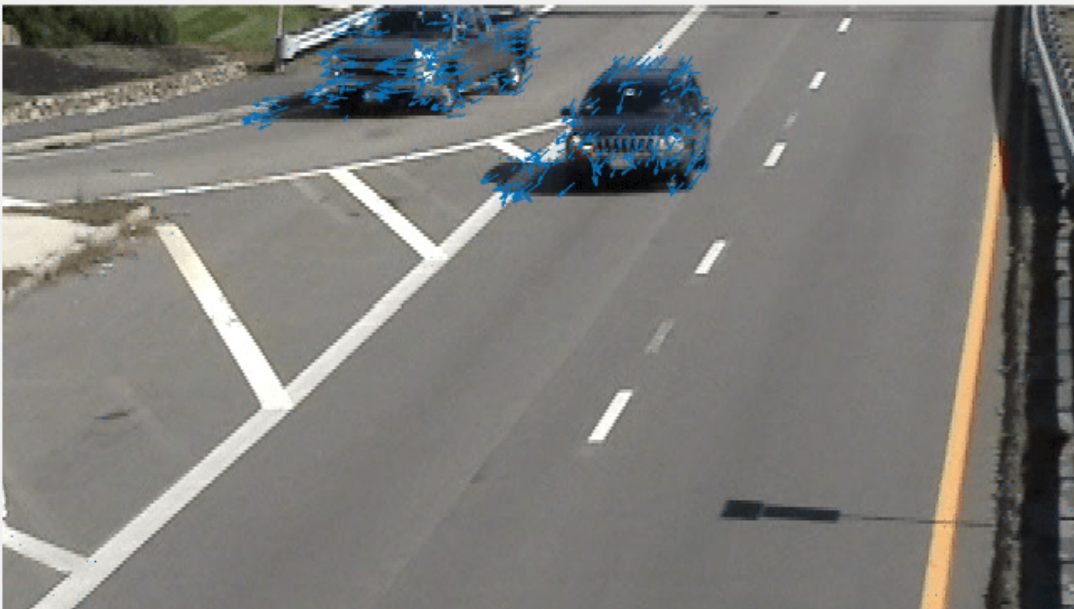

Algorithms

To compute the optical flow between two images, you must solve this optical flow constraint equation:

$$I_x u + I_y v + I_t = 0$$

.

- I_x , I_y , and I_t are the spatiotemporal image brightness derivatives.
- u is the horizontal optical flow.
- v is the vertical optical flow.

Lucas-Kanade Derivative of Gaussian Method

The Lucas-Kanade method computes I_t using a derivative of Gaussian filter.

To solve the optical flow constraint equation for u and v :

- 1 Compute I_x and I_y using the following steps:
 - a Use a Gaussian filter to perform temporal filtering. Specify the temporal filter characteristics such as the standard deviation and number of filter coefficients using the `NumFrames` property.
 - b Use a Gaussian filter and the derivative of a Gaussian filter to smooth the image using spatial filtering. Specify the standard deviation and length of the image smoothing filter using the `ImageFilterSigma` property.
- 2 Compute I_t between images 1 and 2 using the following steps:
 - a Use the derivative of a Gaussian filter to perform temporal filtering. Specify the temporal filter characteristics such as the standard deviation and number of filter coefficients using the `NumFrames` property.
 - b Use the filter described in step 1b to perform spatial filtering on the output of the temporal filter.
- 3 Smooth the gradient components, I_x , I_y , and I_t , using a gradient smoothing filter. Use the `GradientFilterSigma` property to specify the standard deviation and the number of filter coefficients for the gradient smoothing filter.
- 4 Solve the 2-by-2 linear equations for each pixel using the following method:

$$\text{If } A = \begin{bmatrix} a & b \\ b & c \end{bmatrix} = \begin{bmatrix} \sum W^2 I_x^2 & \sum W^2 I_x I_y \\ \sum W^2 I_y I_x & \sum W^2 I_y^2 \end{bmatrix}$$

Then the eigenvalues of A are $\lambda_i = \frac{a+c}{2} \pm \frac{\sqrt{4b^2 + (a-c)^2}}{2}; i = 1, 2$

- When the algorithm finds the eigenvalues, it compares them to the threshold, τ , that corresponds to the value you enter for the `NoiseThreshold` property. The results fall into one of the following cases:

Case 1: $\lambda_1 \geq \tau$ and $\lambda_2 \geq \tau$

A is nonsingular, so the algorithm solves the system of equations using Cramer's rule.

Case 2: $\lambda_1 \geq \tau$ and $\lambda_2 < \tau$

A is singular (noninvertible), so the algorithm normalizes the gradient flow to calculate u and v .

Case 3: $\lambda_1 < \tau$ and $\lambda_2 < \tau$

The optical flow, u and v , is 0.

References

- [1] Barron, J. L., D. J. Fleet, S. S. Beauchemin, and T. A. Burkitt. "Performance of optical flow techniques." In *Proceedings of the IEEE Conference on Computer Vision and Pattern Recognition (CVPR)*, 236-242. Champaign, IL: CVPR, 1992.

Extended Capabilities

C/C++ Code Generation

Generate C and C++ code using MATLAB® Coder™.

See Also

[quiver](#) | [opticalFlow](#) | [opticalFlowHS](#) | [opticalFlowLK](#) | [opticalFlowFarneback](#)

Introduced in R2015a

opticalFlowFarneback

Object for estimating optical flow using Farneback method

Description

Create an optical flow object for estimating the direction and speed of moving objects using the Farneback method. Use the object function `estimateFlow` to estimate the optical flow vectors. Using the `reset` object function, you can reset the internal state of the optical flow object.

Creation

Syntax

```
opticFlow = opticalFlowFarneback  
opticFlow = opticalFlowFarneback(Name, Value)
```

Description

`opticFlow = opticalFlowFarneback` returns an optical flow object that you can use to estimate the direction and speed of the moving objects in a video. The optical flow is estimated using the Farneback method.

`opticFlow = opticalFlowFarneback(Name, Value)` returns an optical flow object with properties specified as one or more `Name, Value` pair arguments. Any unspecified properties have default values. Enclose each property name in quotes.

For example, `opticalFlowFarneback('NumPyramidLevels', 3)`

Properties

NumPyramidLevels — Number of pyramid layers

3 (default) | positive scalar

Number of pyramid layers, specified as a positive scalar. The value includes the initial image as one of the layers. When you set this value to 1, the function estimates optical flow only from the original image frame and does not perform pyramid decomposition. The recommended values are between 1 and 4.

PyramidScale — Image scale

0.5 (default) | positive scalar in the range (0,1)

Image scale, specified as a positive scalar in the range (0,1). The value specifies the rate of downsampling at each pyramid level. A value of 0.5 creates a classical pyramid, where the resolution of the pyramid reduces by a factor of two at each level. The lowest level in the pyramid has the highest resolution.

NumIterations — Number of search iterations per pyramid level

3 (default) | positive integer

Number of search iterations per pyramid level, specified as a positive integer. The Farneback algorithm performs an iterative search for the key points at each pyramid level, until convergence.

NeighborhoodSize — Size of the pixel neighborhood

5 (default) | positive integer

Size of the pixel neighborhood, specified as a positive integer. Increase the neighborhood size to increase blurred motion. The blur motion yields a more robust estimation of optical flow. A typical value for NeighborhoodSize is 5 or 7.

FilterSize — Averaging filter size

15 (default) | positive integer in the range [2, Inf)

Averaging filter size, specified as a positive integer in the range [2, Inf). After the algorithm computes the displacement (flow), the averaging over neighborhoods is done using a Gaussian filter of size (FilterSize * FilterSize). Also, the pixels close to the borders are given a reduced weight because the algorithm assumes that the polynomial expansion coefficients are less reliable there. Increasing the filter size increases the robustness of the algorithm to image noise. The larger the filter size, the greater the algorithm handles image noise and fast motion detection, making it more robust.

Object Functions

estimateFlow Estimate optical flow
 reset Reset the internal state of the optical flow estimation object

Examples

Estimate Optical Flow Using Farneback Method

Read a video file. Specify the timestamp of the frame to be read.

```
vidReader = VideoReader('visiontraffic.avi', 'CurrentTime', 11);
```

Create an optical flow object for estimating the optical flow using Farneback method. The output is an object specifying the optical flow estimation method and its properties.

```
opticFlow = opticalFlowFarneback
```

```
opticFlow =  
    opticalFlowFarneback with properties:
```

```
    NumPyramidLevels: 3  
        PyramidScale: 0.5000  
    NumIterations: 3  
    NeighborhoodSize: 5  
        FilterSize: 15
```

Create a custom figure window to visualize the optical flow vectors.

```
h = figure;  
movegui(h);  
hViewPanel = uipanel(h, 'Position', [0 0 1 1], 'Title', 'Plot of Optical Flow Vectors');  
hPlot = axes(hViewPanel);
```

Read the image frames and convert to grayscale images. Estimate the optical flow from consecutive image frames. Display the current image frame and plot the optical flow vectors as quiver plot.

```
while hasFrame(vidReader)
    frameRGB = readFrame(vidReader);
    frameGray = im2gray(frameRGB);
    flow = estimateFlow(opticFlow,frameGray);

    imshow(frameRGB)
    hold on
    plot(flow,'DecimationFactor',[5 5],'ScaleFactor',2,'Parent',hPlot);
    hold off
    pause(10^-3)
end
```

Plot of Optical Flow Vectors

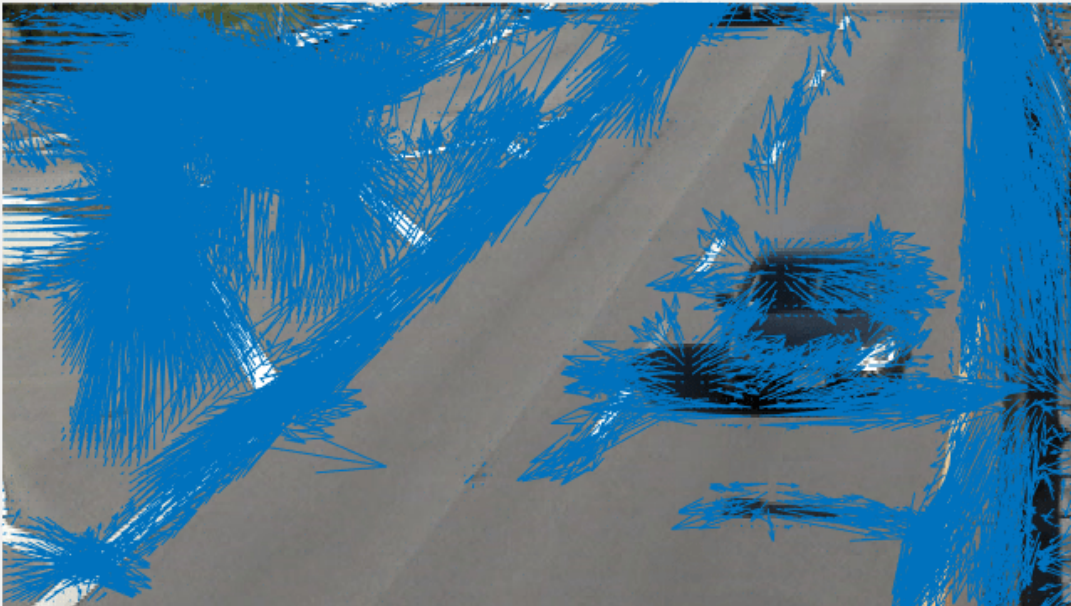

Plot of Optical Flow Vectors

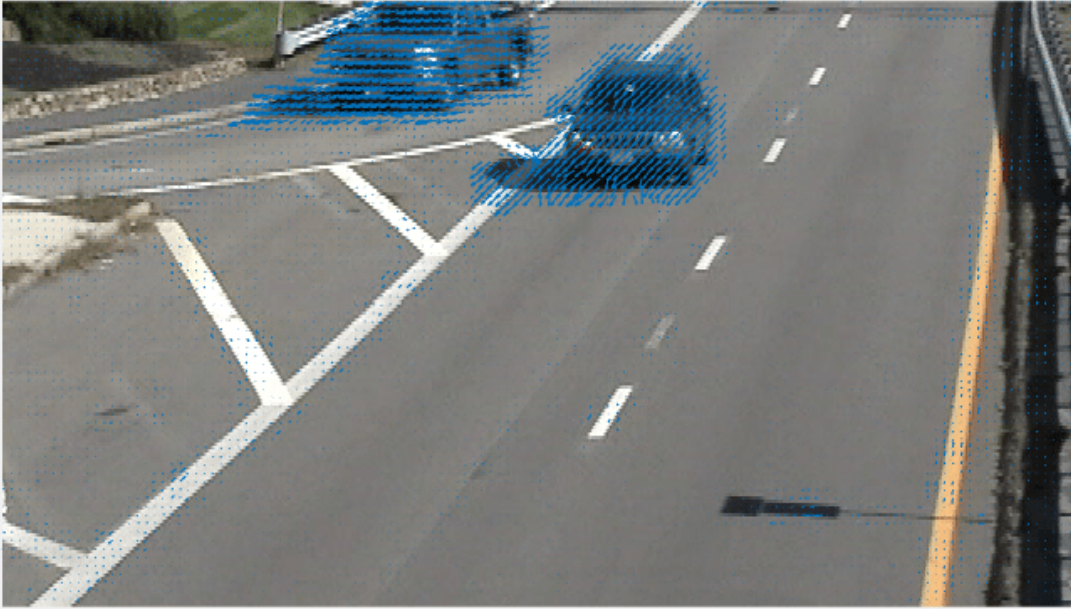

Algorithms

The Farneback algorithm generates an image pyramid, where each level has a lower resolution compared to the previous level. When you select a pyramid level greater than 1, the algorithm can track the points at multiple levels of resolution, starting at the lowest level. Increasing the number of pyramid levels enables the algorithm to handle larger displacements of points between frames. However, the number of computations also increases. The diagram shows an image pyramid with three levels.

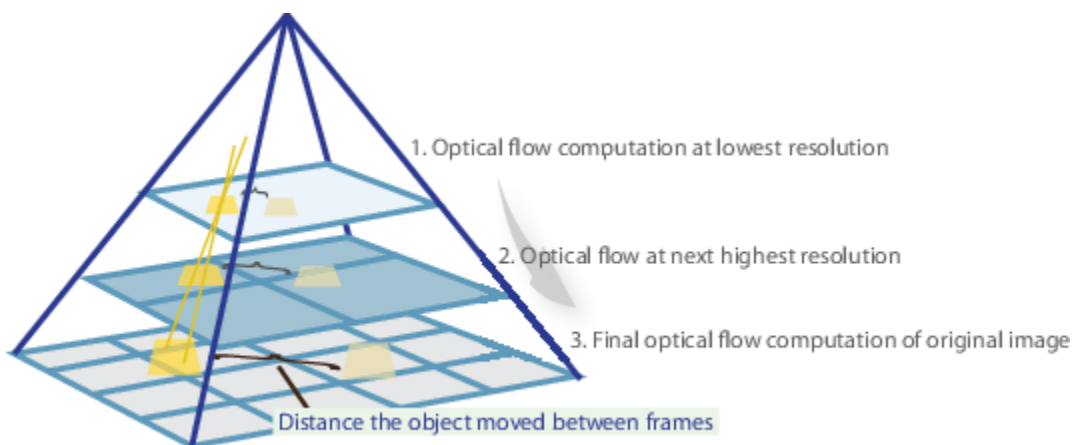

The tracking begins in the lowest resolution level, and continues until convergence. The point locations detected at a level are propagated as keypoints for the succeeding level. In this way, the algorithm refines the tracking with each level. The pyramid decomposition enables the algorithm to handle large pixel motions, which can be distances greater than the neighborhood size.

References

- [1] Farneback, G. "Two-Frame Motion Estimation Based on Polynomial Expansion." In *Proceedings of the 13th Scandinavian Conference on Image Analysis*, 363 - 370. Halmstad, Sweden: SCIA, 2003.

Extended Capabilities

C/C++ Code Generation

Generate C and C++ code using MATLAB® Coder™.

Usage notes and limitations:

- Generates portable C code using a C++ compiler that links to OpenCV (Version 3.4.0) libraries. See "Portable C Code Generation for Functions That Use OpenCV Library".

See Also

[quiver](#) | [opticalFlow](#) | [opticalFlowLKDoG](#) | [opticalFlowHS](#) | [opticalFlowLK](#)

Introduced in R2015b

estimateFlow

Estimate optical flow

Syntax

```
flow = estimateFlow(opticFlow,I)
```

Description

`flow = estimateFlow(opticFlow,I)` estimates optical flow between two consecutive video frames.

Examples

Estimate Optical Flow Using Horn-Schunck Method

Create a `VideoReader` object for the input video file, `visiontraffic.avi`. Specify the timestamp of the frame to read as 11.

```
vidReader = VideoReader('visiontraffic.avi','CurrentTime',11);
```

Specify the optical flow estimation method as `opticalFlowHS`. The output is an object specifying the optical flow estimation method and its properties.

```
opticFlow = opticalFlowHS
opticFlow =
    opticalFlowHS with properties:
        Smoothness: 1
        MaxIteration: 10
        VelocityDifference: 0
```

Create a custom figure window to visualize the optical flow vectors.

```
h = figure;
movegui(h);
hViewPanel = uipanel(h,'Position',[0 0 1 1],'Title','Plot of Optical Flow Vectors');
hPlot = axes(hViewPanel);
```

Read image frames from the `VideoReader` object and convert to grayscale images. Estimate the optical flow from consecutive image frames. Display the current image frame and plot the optical flow vectors as quiver plot.

```
while hasFrame(vidReader)
    frameRGB = readFrame(vidReader);
    frameGray = im2gray(frameRGB);
    flow = estimateFlow(opticFlow,frameGray);
    imshow(frameRGB)
    hold on
```

```
plot(flow, 'DecimationFactor', [5 5], 'ScaleFactor', 60, 'Parent', hPlot);  
hold off  
pause(10^-3)  
end
```

Plot of Optical Flow Vectors

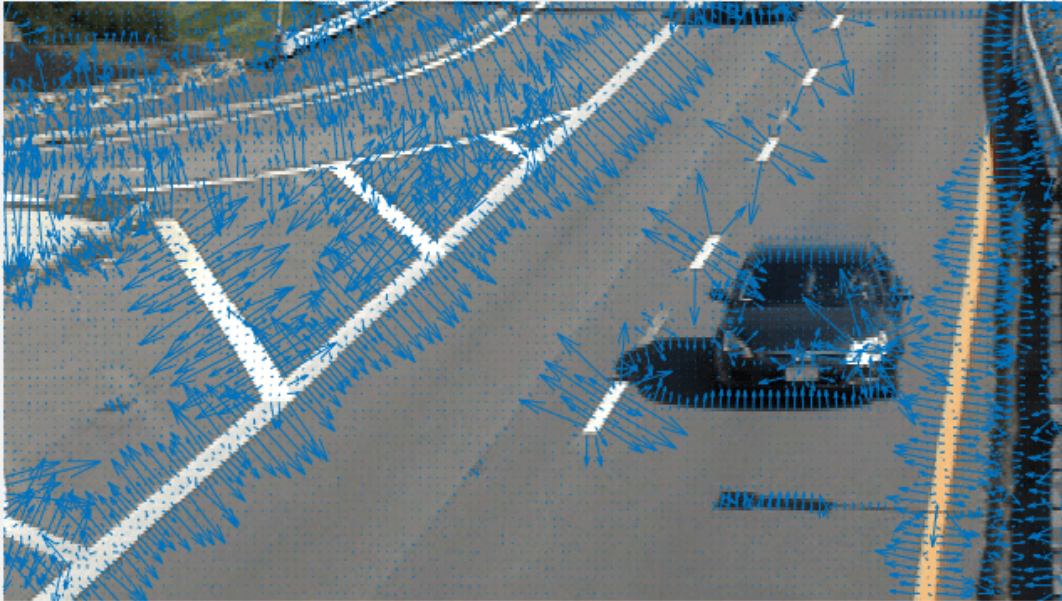

Plot of Optical Flow Vectors

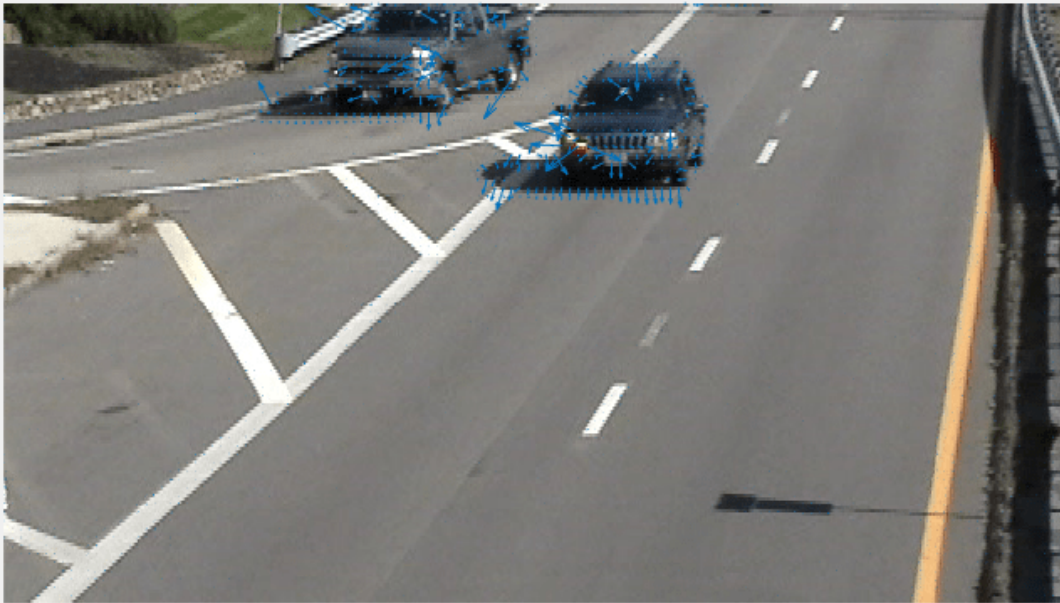

Input Arguments

opticFlow – Object for optical flow estimation

`opticFlowFarneback` object | `opticFlowHS` | object | `opticFlowLK` object | `opticFlowLKDoG` object

Object for optical flow estimation, specified as one of the following:

- `opticFlowFarneback` object
- `opticFlowHS` object
- `opticFlowLK` object
- `opticFlowLKDoG` object

The input `opticFlow` defines the optical flow estimation method and its properties used for estimating the optical flow velocity matrices.

I – Current video frame

2-D grayscale image

Current video frame, specified as a 2-D grayscale image of size m -by- n . The input image is generated from the current video frame read using the `VideoReader` object. The video frames in RGB format must be converted to 2-D grayscale images for estimating the optical flow.

Output Arguments

flow — Object for storing optical flow velocity matrices

`opticalFlow` object

Object for storing optical flow velocity matrices, returned as an `opticalFlow` object.

Algorithms

The function estimates optical flow of the input video using the method specified by the input object `opticFlow`. The optical flow is estimated as the motion between two consecutive video frames. The video frame T at the given instant $t_{current}$ is referred as current frame and the video frame $T-1$ is referred as previous frame. The initial value of the previous frame at time $t_{current} = 0$ is set as a uniform image of grayscale value 0.

Note If you specify `opticFlow` as `opticalFlowLKDoG` object, then the estimation delays by an amount relative to the number of video frames. The amount of delay depends on the value of `NumFrames` defined in `opticalFlowLKDoG` object. The optic flow estimated for a video frame at $t_{current}$ corresponds to the video frame at time $t_{flow} = (t_{current} - (NumFrames - 1))/2$. $t_{current}$ is the time of the current video frame.

Extended Capabilities

C/C++ Code Generation

Generate C and C++ code using MATLAB® Coder™.

See Also

`reset`

Introduced in R2015a

reset

Reset the internal state of the optical flow estimation object

Syntax

```
reset(opticFlow)
```

Description

`reset(opticFlow)` resets the internal state of the optical flow estimation object. The previous frame is reset to its initial value which is a uniform image of intensity value 0.

Input Arguments

opticFlow — Object for optical flow estimation

`opticalFlowFarneback` object | `opticalFlowHS` object | `opticalFlowLK` object | `opticalFlowLKDoG` object

Object for optical flow estimation, specified as one of the following:

- `opticalFlowFarneback` object
- `opticalFlowHS` object
- `opticalFlowLK` object
- `opticalFlowLKDoG` object

The input `opticFlow` defines the optical flow estimation method and its properties used for estimating the optical flow velocity matrices.

Extended Capabilities

C/C++ Code Generation

Generate C and C++ code using MATLAB® Coder™.

See Also

`estimateFlow`

Introduced in R2015a

vision.PeopleDetector

Package: vision

Detect upright people using HOG features

Description

The people detector object detects people in an input image using the Histogram of Oriented Gradient (HOG) features and a trained Support Vector Machine (SVM) classifier. The object detects unoccluded people in an upright position.

To detect people in an image:

- 1 Create the `vision.PeopleDetector` object and set its properties.
- 2 Call the object with arguments, as if it were a function.

To learn more about how System objects work, see [What Are System Objects?](#)

Creation

Syntax

```
peopleDetector = vision.PeopleDetector  
peopleDetector = vision.PeopleDetector(model)  
peopleDetector = vision.PeopleDetector(Name,Value)
```

Description

`peopleDetector = vision.PeopleDetector` returns a people detector object, `peopleDetector`, that tracks a set of points in a video.

`peopleDetector = vision.PeopleDetector(model)` creates a people detector object and sets the `ClassificationModel` property to `model`.

`peopleDetector = vision.PeopleDetector(Name,Value)` sets properties using one or more name-value pairs. Enclose each property name in quotes. For example, `peopleDetector = vision.PeopleDetector('ClassificationModel','UprightPeople_128x64')`

Properties

Unless otherwise indicated, properties are *nontunable*, which means you cannot change their values after calling the object. Objects lock when you call them, and the `release` function unlocks them.

If a property is *tunable*, you can change its value at any time.

For more information on changing property values, see [System Design in MATLAB Using System Objects](#).

ClassificationModel — Name of classification model

'UprightPeople_128x64' (default) | 'UprightPeople_96x48'

Name of classification model, specified as 'UprightPeople_128x64' or 'UprightPeople_96x48'. The pixel dimensions indicate the image size used for training.

The images used to train the models include background pixels around the person. Therefore, the actual size of a detected person is smaller than the training image size.

ClassificationThreshold — People classification threshold

1 (default) | nonnegative scalar value

People classification threshold, specified as a nonnegative scalar value. Use this threshold to control the classification of individual image subregions during multiscale detection. The threshold controls whether a subregion gets classified as a person. You can increase this value when there are many false detections. The higher the threshold value, the more stringent the requirements are for the classification. Vary the threshold over a range of values to find the optimum value for your data set. Typical values range from 0 to 4.

Tunable: Yes

MinSize — Smallest region containing a person

[] (default) | two-element vector

Smallest region containing a person, specified in pixels as a two-element vector, [*height width*]. Set this property to the minimum size region containing a person. You can reduce computation time when you set this property. To do so, set this property to a value larger than the image size used to train the classification model. When you do not specify this property, the detector sets it to the image size used to train the classification model.

Tunable: Yes

MaxSize — Largest region containing a person

[] (default) | two-element vector

Largest region that contains a person, specified in pixels as a two-element vector, [*height width*]. Set this property to the largest region containing a person. You can reduce computation time when you set this property. To do so, set this property to a value smaller than the size of the input image. When you do not specify this property, the detector sets it to the input image size. This property is tunable.

ScaleFactor — Multiscale object detection scaling

1.05 (default) | numeric value greater than 1.0001

Multiscale object detection scaling, specified as a value greater than 1.0001. The scale factor incrementally scales the detection resolution between `MinSize` and `MaxSize`. You can set the scale factor to an ideal value using:

$$\text{size}(I)/(\text{size}(I)-0.5)$$

The object calculates the detection resolution at each increment.

$$\text{round}(\text{TrainingSize} * (\text{ScaleFactor}^N))$$

In this case, the *TrainingSize* is [128 64] for the 'UprightPeople_128x64' model and [96 48] for the 'UprightPeople_96x48' model. *N* is the increment. Decreasing the scale factor can increase the detection accuracy. However, doing so increases the computation time. This property is tunable.

WindowStride — Detection window stride`[8 8]` (default) | scalar | two-element vector

Detection window stride in pixels, specified as a scalar or a two-element vector, `[x y]`. The detector uses the window stride to slide the detection window across the image. When you specify this value as a vector, the first and second elements are the stride size in the *x* and *y* directions. When you specify this value as a scalar, the stride is the same for both *x* and *y*. Decreasing the window stride can increase the detection accuracy. However, doing so increases computation time. Increasing the window stride beyond `[8 8]` can lead to a greater number of missed detections. This property is tunable.

MergeDetections — Merge detection control`true` | `false`

Merge detection control, specified as `true` or `false`. This property controls whether similar detections are merged. Set this property to `true` to merge bounding boxes using a mean-shift based algorithm. Set this property to `false` to output the unmerged bounding boxes.

For more flexibility and control of merging parameters, you can use the `selectStrongestBbox` function in place of the `MergeDetections` algorithm. To do this, set the `MergeDetections` property to `false`. See the “Tracking Pedestrians from a Moving Car” example, which shows the use of the people detector and the `selectStrongestBbox` function.

UseROI — Use region of interest`false` (default) | `true`

Use region of interest, specified as `true` or `false`. Set this property to `true` to detect objects within a rectangular region of interest within the input image.

Usage

Syntax

```
bboxes = peopleDetector(I)
[bboxes, scores] = peopleDetector(I)
[ ___ ] = peopleDetector(I, roi)
```

Description

`bboxes = peopleDetector(I)` performs multiscale object detection on the input image, *I* and returns an *M*-by-4 matrix defining *M* bounding boxes. *M* represents the number of detected people. Each row of the output matrix, `BBOXES`, contains a four-element vector, `[x y width height]`. This vector specifies, in pixels, the upper-left corner and size, of a bounding box. When no people are detected, the `step` method returns an empty vector. The input image, *I*, must be a grayscale or truecolor (RGB) image.

`[bboxes, scores] = peopleDetector(I)` additionally returns a confidence value for the detections.

`[___] = peopleDetector(I, roi)` detects people within the rectangular search region, *roi*.

Input Arguments

I — Input image

grayscale | truecolor (RGB)

Input image, specified as grayscale or truecolor (RGB).

roi — Rectangular region of interest

four-element vector (default)

Rectangular region of interest within image I, specified as a four-element vector, [*x y width height*].

model — Classification model

'UprightPeople_128x64' (default) | 'UprightPeople_96x48'

Classification model, specified as 'UprightPeople_128x64' or 'UprightPeople_96x48'.

Output Arguments

peopleDetector — People detector

object (default)

People detector object, returned as an object. The detector detects people in an input image using the Histogram of Oriented Gradient (HOG) features and a trained SVM classifier. The object detects unoccluded people in an upright position.

Object Functions

To use an object function, specify the System object as the first input argument. For example, to release system resources of a System object named *obj*, use this syntax:

```
release(obj)
```

Common to All System Objects

step	Run System object algorithm
release	Release resources and allow changes to System object property values and input characteristics
reset	Reset internal states of System object

Examples

Detect People

Create a people detector and load the input image.

```
peopleDetector = vision.PeopleDetector;  
I = imread('visionteam1.jpg');
```

Detect people using the people detector object.

```
[bboxes,scores] = peopleDetector(I);
```

Annotate detected people.

```
I = insertObjectAnnotation(I, 'rectangle', bboxes, scores);  
figure, imshow(I)  
title('Detected people and detection scores');
```

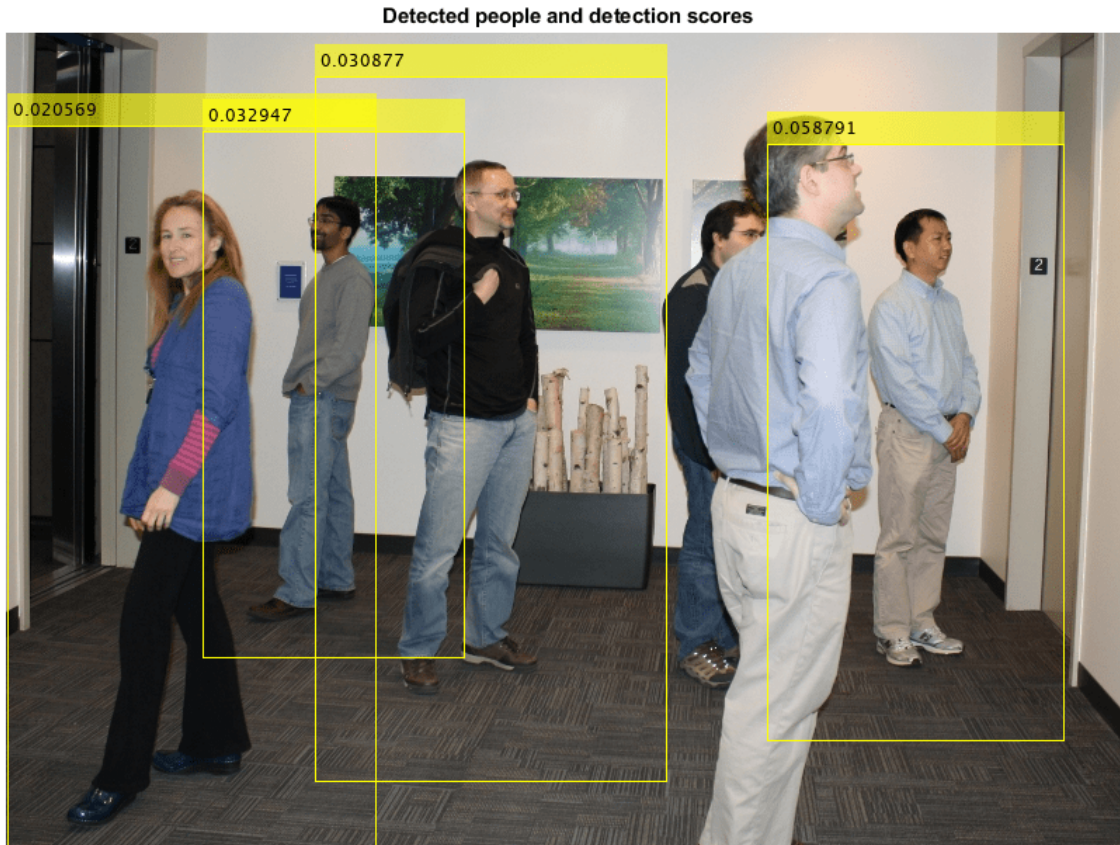

References

- [1] Dalal, N. and B. Triggs. "Histograms of Oriented Gradients for Human Detection," *Proceedings of IEEE Conference on Computer Vision and Pattern Recognition*, June 2005, pp. 886-893.

Extended Capabilities

C/C++ Code Generation

Generate C and C++ code using MATLAB® Coder™.

Usage notes and limitations:

- Generates portable C code using a C++ compiler that links to OpenCV (Version 3.4.0) libraries. See "Portable C Code Generation for Functions That Use OpenCV Library".
- See "System Objects in MATLAB Code Generation" (MATLAB Coder).

See Also

`vision.CascadeObjectDetector` | `detectPeopleACF` | `insertObjectAnnotation` | `extractHOGFeatures`

Topics

“Tracking Pedestrians from a Moving Car”

“Multiple Object Tracking”

Introduced in R2012b

semanticSegmentationMetrics

Semantic segmentation quality metrics

Description

A `semanticSegmentationMetrics` object encapsulates semantic segmentation quality metrics for a set of images.

Creation

Create a `semanticSegmentationMetrics` object using the `evaluateSemanticSegmentation` function.

Properties

ConfusionMatrix — Confusion matrix

table

This property is read-only.

Confusion matrix, specified as a table with C rows and columns, where C is the number of classes in the semantic segmentation. Each table element (i,j) is the count of pixels known to belong to class i but predicted to belong to class j .

NormalizedConfusionMatrix — Normalized confusion matrix

table

This property is read-only.

Normalized confusion matrix, specified as a table with C rows and columns, where C is the number of classes in the semantic segmentation. Each table element (i,j) is the count of pixels known to belong to class i but predicted to belong to class j , divided by the total number of pixels predicted in class j . Elements are in the range $[0, 1]$.

DataSetMetrics — Data set metrics

table

This property is read-only.

Semantic segmentation metrics aggregated over the data set, specified as a table with one row. `DataSetMetrics` has up to five columns, corresponding to the metrics that were specified by the 'Metrics' name-value pair used with `evaluateSemanticSegmentation`:

- `GlobalAccuracy` — Ratio of correctly classified pixels to total pixels, regardless of class.
- `MeanAccuracy` — Ratio of correctly classified pixels in each class to total pixels, averaged over all classes. The value is equal to the mean of `ClassMetrics.Accuracy`.
- `MeanIoU` — Average intersection over union (IoU) of all classes. The value is equal to the mean of `ClassMetrics.IoU`.

- **WeightedIoU** — Average IoU of all classes, weighted by the number of pixels in the class.
- **MeanBFScore** — Average boundary F1 (BF) score of all images. The value is equal to the mean of `ImageMetrics.BFScore`. This metric is not available when you create a `semanticSegmentationMetrics` object by using a confusion matrix as the input to `evaluateSemanticSegmentation`.

ClassMetrics — Class metrics

table

This property is read-only.

Semantic segmentation metrics for each class, specified as a table with C rows, where C is the number of classes in the semantic segmentation. `ClassMetrics` has up to three columns, corresponding to the metrics that were specified by the 'Metrics' name-value pair used with `evaluateSemanticSegmentation`:

- **Accuracy** — Ratio of correctly classified pixels in each class to the total number of pixels belonging to that class according to the ground truth. Accuracy can be expressed as:

$$\text{Accuracy} = (TP + TN) / (TP + TN + FP + FN)$$

	Positive	Negative
Positive	TP: True Positive	FN: False Negative
Negative	FP: False Positive	TN: True Negative

TP: True positives and FN is the number of false negatives.

- **IoU** — Ratio of correctly classified pixels to the total number of pixels that are assigned that class by the ground truth and the predictor. IoU can be expressed as:

$$\text{IoU} = TP / (TP + FP + FN)$$

The image describes the true positives (TP), false positives (FP), and false negatives (FN).

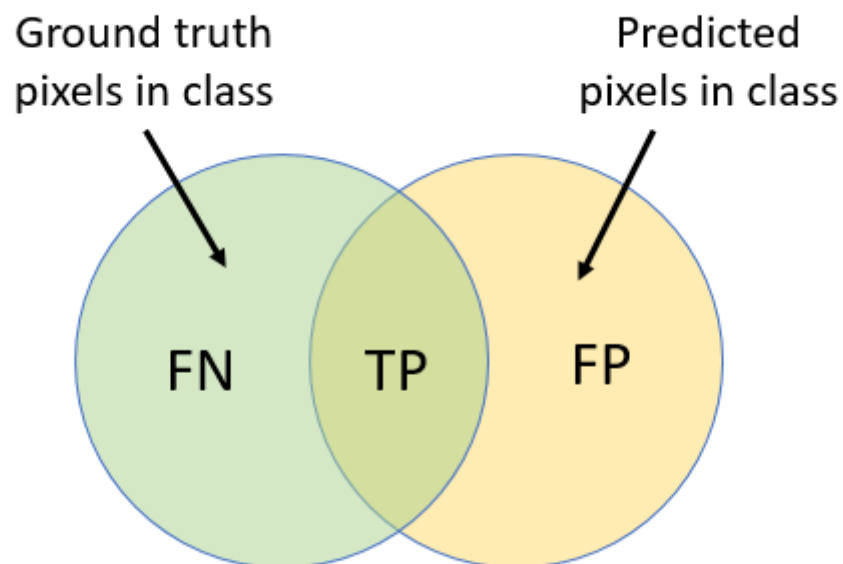

- **MeanBFScore** — Boundary F1 score for each class, averaged over all images. This metric is not available when you create a `semanticSegmentationMetrics` object by using a confusion matrix as the input to `evaluateSemanticSegmentation`.

ImageMetrics — Image metrics

table

This property is read-only.

Semantic segmentation metrics for each image in the data set, specified as a table with N rows, where N is the number of images in the data set. `ImageMetrics` has up to five columns, corresponding to the metrics that were specified by the 'Metrics' name-value pair used with `evaluateSemanticSegmentation`:

- **GlobalAccuracy** — Ratio of correctly classified pixels to total pixels, regardless of class.
- **MeanAccuracy** — Ratio of correctly classified pixels to total pixels, averaged over all classes in the image.
- **MeanIoU** — Average IoU of all classes in the image.
- **WeightedIoU** — Average IoU of all classes in the image, weighted by the number of pixels in each class.
- **MeanBFScore** — Average BF score of each class in the image. This metric is not available when you create a `semanticSegmentationMetrics` object by using a confusion matrix as the input to `evaluateSemanticSegmentation`.

Each image metric returns a vector, with one element for each image in the data set. The order of the rows matches the order of the images defined by the input `PixelLabelDatastore` objects representing the data set.

Examples

Evaluate Semantic Segmentation Results

The `triangleImages` data set has 100 test images with ground truth labels. Define the location of the data set.

```
dataSetDir = fullfile(toolboxdir('vision'),'visiondata','triangleImages');
```

Define the location of the test images.

```
testImagesDir = fullfile(dataSetDir,'testImages');
```

Define the location of the ground truth labels.

```
testLabelsDir = fullfile(dataSetDir,'testLabels');
```

Create an `imageDatastore` holding the test images.

```
imds = imageDatastore(testImagesDir);
```

Define the class names and their associated label IDs.

```
classNames = ["triangle","background"];
labelIDs   = [255 0];
```

Create a `pixelLabelDatastore` holding the ground truth pixel labels for the test images.

```
pxdsTruth = pixelLabelDatastore(testLabelsDir,classNames,labelIDs);
```

Load a semantic segmentation network that has been trained on the training images of `triangleImages`.

```
net = load('triangleSegmentationNetwork');
net = net.net;
```

Run the network on the test images. Predicted labels are written to disk in a temporary directory and returned as a `pixelLabelDatastore`.

```
pxdsResults = semanticseg(imds,net,"WriteLocation",tempdir);
```

```
Running semantic segmentation network
```

```
-----
* Processed 100 images.
```

Evaluate the prediction results against the ground truth.

```
metrics = evaluateSemanticSegmentation(pxdsResults,pxdsTruth);
```

```
Evaluating semantic segmentation results
```

```
-----
* Selected metrics: global accuracy, class accuracy, IoU, weighted IoU, BF score.
* Processed 100 images.
* Finalizing... Done.
* Data set metrics:
```

GlobalAccuracy	MeanAccuracy	MeanIoU	WeightedIoU	MeanBFScore
0.90624	0.95085	0.61588	0.87529	0.40652

Display the properties of the `semanticSegmentationMetrics` object.

```
metrics
```

```
metrics =
  semanticSegmentationMetrics with properties:
```

```
    ConfusionMatrix: [2x2 table]
  NormalizedConfusionMatrix: [2x2 table]
      DataSetMetrics: [1x5 table]
        ClassMetrics: [2x3 table]
        ImageMetrics: [100x5 table]
```

Display the classification accuracy, the intersection over union, and the boundary F-1 score for each class. These values are stored in the `ClassMetrics` property.

```
metrics.ClassMetrics
```

```
ans=2x3 table
```

	Accuracy	IoU	MeanBFScore
triangle	1	0.33005	0.028664
background	0.9017	0.9017	0.78438

Display the normalized confusion matrix that is stored in the `NormalizedConfusionMatrix` property.

```
metrics.ConfusionMatrix
```

```
ans=2×2 table
```

	triangle	background
triangle	4730	0
background	9601	88069

See Also

[evaluateSemanticSegmentation](#) | [plotconfusion](#) | [jaccard](#) | [bfscore](#)

Topics

“Getting Started with Semantic Segmentation Using Deep Learning”

“Deep Learning in MATLAB” (Deep Learning Toolbox)

Introduced in R2017b

vision.StandardDeviation

Package: vision

Find standard deviation values in input or sequence of inputs

Description

Find the standard deviation values in an input or sequence of inputs.

To track a set of points:

- 1 Create the `vision.StandardDeviation` object and set its properties.
- 2 Call the object with arguments, as if it were a function.

To learn more about how System objects work, see [What Are System Objects?](#)

Creation

Syntax

```
stdDev = vision.StandardDeviation
stdDev = vision.StandardDeviation(Name,Value)
```

Description

`stdDev = vision.StandardDeviation` returns an object, `stdDev`, that computes the value and index of the maximum elements in an input or a sequence of inputs.

`stdDev = vision.StandardDeviation(Name,Value)` sets properties using one or more name-value pairs. Enclose each property name in quotes. For example, `stdDev = vision.Maximum('RunningStandardDeviation',false)`

Properties

Unless otherwise indicated, properties are *nontunable*, which means you cannot change their values after calling the object. Objects lock when you call them, and the `release` function unlocks them.

If a property is *tunable*, you can change its value at any time.

For more information on changing property values, see [System Design in MATLAB Using System Objects](#).

ValueOutputPort — Output Minimum value

true (default) | false

Output standard deviation value, specified as `true` or `false`. Set this property to `true` to output the Minimum value of the input. This property applies when you set the `RunningStandardDeviation` property to `false`.

RunningStandardDeviation — Calculate over single input or multiple inputs`false (default) | true`

Calculate over single input or multiple inputs, specified as `true` or `false`. When you set this property to `true`, the object computes the standard deviation value over a sequence of inputs. When you set this property to `false`, the object computes the standard deviation value over the current input.

ResetInputPort — Additional input to enable resetting of running standard deviation`false (default) | true`

Additional input to enable resetting of running standard deviation, specified as `true` or `false`. When you set this property to `true`, a reset input must be specified to reset the running standard deviation. This property applies only when you set the `RunningStandardDeviation` property to `true`.

ResetCondition — Condition that triggers resetting of running standard deviation`'Non-zero' (default) | 'Rising edge' | 'Falling edge' | 'Either edge'`

Condition that triggers resetting of running standard deviation, specified as `'Rising edge'`, `'Falling edge'`, `'Either edge'`, or `'Non-zero'`. This property applies only when you set the `ResetInputPort` property to `true`.

Dimension — Dimension to operate along`'Column' (default) | {'All'} | 'Row' | 'Custom'`

Dimension to operate along, specified as `{'All'}`, `'Row'`, `'Column'`, or `'Custom'`. This property applies only when you set the `RunningStandardDeviation` property to `false`.

CustomDimension — Numerical dimension to calculate over`1 (default) | numerical scalar`

Numerical dimension to calculate over, specified as a numerical scalar. This property only applies when you set the `Dimension` property to `'Custom'`.

ROIProcessing — Enable region-of-interest processing`false (default) | true`

Enable region-of-interest processing, specified as `true` or `false`. This property applies when you set the `Dimension` property to `'All'` and the `RunningStandardDeviation` property to `false`.

ROIForm — Type of ROI`'Rectangles' (default) | 'Lines' | 'Label matrix' | 'Binary mask'`

Type of ROI, specified as `'Rectangles'`, `'Lines'`, `'Label matrix'`, or `'Binary mask'`. This property applies only when you set the `ROIProcessing` property to `true`.

ROIPortion — ROI or perimeter calculation`'Entire ROI' (default) | 'ROI perimeter'`

ROI or perimeter calculation, specified as `'Entire ROI'` or `'ROI perimeter'`. This property applies only when you set the `ROIForm` property to `'Rectangles'`.

ROIStatistics — Calculate statistics for each ROI or one for all ROIs`'Individual statistics for each ROI' (default) | 'Single statistic for all ROIs'`

Calculate statistics for each ROI or one for all ROIs, specified as 'Individual statistics for each ROI' or 'Single statistic for all ROIs'. This property applies only when you set the 'ROIForm' property to 'Rectangles', 'Lines', or 'Label matrix'.

ValidityOutputPort — Flag to indicate if any part of ROI is outside input image

false (default) | true

Flag to indicate if any part of ROI is outside input image, specified as true or false.

This applies when you set the ROIForm property to 'Lines' or 'Rectangles'.

Set this property to true to return the validity of the specified label numbers. This applies when you set the ROIForm property to 'Label matrix'.

Usage

Syntax

```
[value,index] = stdDev(input)
index = stdDev(input)
```

```
[ ___ ] = stdDev(I,ROI)
[ ___ ,flag] = stdDev(I,ROI)
```

```
[ ___ ] = stdDev(I,label,labelNumbers)
[ ___ ,flag] = stdDev(I,label,labelNumbers)
```

Description

[value,index] = stdDev(input) returns the standard deviation value and index of the input.

index = stdDev(input) returns the one-based index of the standard deviation value when you set the IndexOutputPort property to true and the ValueOutputPort property to false. The RunningStandardDeviation property must be set to false.

[___] = stdDev(I,ROI) returns the standard deviation value in the input image within the given region of interest.

[___ ,flag] = stdDev(I,ROI) additionally returns a flag to indicate whether the given ROI is within the bounds of the image.

[___] = stdDev(I,label,labelNumbers) returns the standard deviation of the input image for a region the labels specified in the labelNumbers vector. The regions are defined and labeled in the label matrix.

[___ ,flag] = stdDev(I,label,labelNumbers) additionally returns a flag to indicate whether the input label numbers are valid.

Input Arguments

input — Input data

vector | matrix | multidimensional array

Input data, specified as a vector, matrix, or multidimensional array.

ROI — Region of interest

four-element vector

Region of interest, specified as a four-element vector, [*x y width height*]. This option is available when you set the `ROIProcessing` property to `true` and the `ROIForm` property to `'Lines'`, `'Rectangles'`, or `'Binary Mask'`.

Label — Label numbers

matrix

Label numbers, specified as a matrix. This option is available when you set the `ROIProcessing` property to `true` and the `ROIForm` property to `'Label matrix'`.

LabelNumbers — Label numbers

vector

Label numbers, specified as a vector. This option is available when you set the `ROIProcessing` property to `true` and the `ROIForm` property to `'Label matrix'`.

Output Arguments**value — Minimum value**

same as input

Minimum value, returned as the same data type as the input

index — Index to standard deviation value

one-based index

Index to standard deviation value, returned as a one-based index.

flag — Flag for valid data`true` | `false`

Flag for valid data, returned as `true` or `false`.

Object Functions

To use an object function, specify the System object as the first input argument. For example, to release system resources of a System object named `obj`, use this syntax:

```
release(obj)
```

Common to All System Objects

<code>step</code>	Run System object algorithm
<code>release</code>	Release resources and allow changes to System object property values and input characteristics
<code>reset</code>	Reset internal states of System object

Examples

Determine Standard Deviation in Grayscale Image

Read a color image.

```
img = imread('peppers.png');
```

Convert the image to grayscale.

```
img = im2single(rgb2gray(img));
```

Find the standard deviation.

```
stdDev = vision.StandardDeviation;  
stdDevValue = stdDev(img);
```

Extended Capabilities

C/C++ Code Generation

Generate C and C++ code using MATLAB® Coder™.

Usage notes and limitations:

- See “System Objects in MATLAB Code Generation” (MATLAB Coder).

See Also

[vision.Maximum](#) | [vision.Mean](#) | [vision.Minimum](#) | [vision.Median](#)

Introduced in R2012a

stereoParameters

Object for storing stereo camera system parameters

Description

The `stereoParameters` object stores the intrinsic and extrinsic parameters of two cameras and their geometric relationship.

Creation

You can create a `stereoParameters` object using the `stereoParameters` function described here. You can also create a `stereoParameters` object by using the `estimateCameraParameters` with an M -by-2-by- numImages -by-2 array of input image points, where M is the number of keypoint coordinates in each pattern.

Syntax

```
stereoParams = stereoParameters(cameraParameters1, cameraParameters2,  
tformOfCamera2)  
stereoParams = stereoParameters(cameraParameters1, cameraParameters2,  
rotationOfCamera2, translationOfCamera2)  
stereoParams = stereoParameters(paramStruct)
```

Description

`stereoParams = stereoParameters(cameraParameters1, cameraParameters2, tformOfCamera2)` returns a stereo camera system parameters object using the camera parameters from two cameras and a `tformOfCamera2` object that specifies the transformation of camera 2 relative to camera 1. `cameraParameters1` and `cameraParameters2` contain the intrinsics and extrinsics of camera 1 and camera 2 respectively.

`stereoParams = stereoParameters(cameraParameters1, cameraParameters2, rotationOfCamera2, translationOfCamera2)` creates a `stereoParameters` object that contains the parameters of a stereo camera system, and sets the `cameraParameters1`, `cameraParameters2`, `rotationOfCamera2`, and `translationOfCamera2` properties.

`stereoParams = stereoParameters(paramStruct)` creates an identical `stereoParameters` object from an existing `stereoParameters` object with parameters stored in `paramStruct`.

Input Arguments

tformOfCamera2 — Transformation of camera 2
`rigid3d` object

Transformation of camera 2 relative to camera 1, specified as a `rigid3d`.

paramStruct — Stereo parameters
`struct`

Stereo parameters, specified as a stereo parameters struct. To get a paramStruct from an existing stereoParameters object, use the toStruct function.

Properties

Intrinsic and extrinsic parameters of the two cameras

cameraParameters1 — Parameters of camera 1

cameraParameters object

Parameters of camera 1, specified as a cameraParameters object. The object contains the intrinsic, extrinsic, and lens distortion parameters of a camera.

cameraParameters2 — Parameters of camera 2

cameraParameters object

Parameters of camera 2, specified as a cameraParameters object. The object contains the intrinsic, extrinsic, and lens distortion parameters of a camera.

Geometric relationship between the two cameras

rotationOfCamera2 — Rotation of camera 2

3-by-3 matrix

Rotation of camera 2 relative to camera 1, specified as a 3-by-3 matrix.

translationOfCamera2 — Translation of camera 2

3-element vector

Translation of camera 2 relative to camera 1, specified as a 3-element vector.

FundamentalMatrix — Fundamental matrix

3-by-3 matrix

Fundamental matrix, stored as a 3-by-3 matrix. The fundamental matrix relates the two stereo cameras, such that the following equation must be true:

$$[P_2 \ 1] * FundamentalMatrix * [P_1 \ 1]' = 0$$

P_1 , the point in image 1 in pixels, corresponds to the point, P_2 , in image 2.

EssentialMatrix — Essential matrix

3-by-3 matrix

Essential matrix, stored as a 3-by-3 matrix. The essential matrix relates the two stereo cameras, such that the following equation must be true:

$$[P_2 \ 1] * EssentialMatrix * [P_1 \ 1]' = 0$$

P_1 , the point in image 1, corresponds to P_2 , the point in image 2. Both points are expressed in normalized image coordinates, where the origin is at the camera's optical center. The x and y pixel coordinates are normalized by the focal length f_x and f_y .

Accuracy of estimated parameters**MeanReprojectionError — Average Euclidean distance**

number of pixels

Average Euclidean distance between reprojected points and detected points over all image pairs, specified in pixels.

Settings for camera parameter estimation**NumPatterns — Number of calibrated patterns**

integer

Number of calibration patterns that estimate the extrinsics of the two cameras, stored as an integer.

WorldPoints — World coordinates*M*-by-2 array

World coordinates of key points in the calibration pattern, specified as an *M*-by-2 array. *M* represents the number of key points in the pattern.

WorldUnits — World points units

'mm' (default) | character vector

World points units, specified as a character vector. The character vector describes the units of measure.

Object Functions`toStruct` Convert a stereo parameters object into a struct**Examples****Stereo Camera Calibration**

Specify calibration images.

```
leftImages = imageDatastore(fullfile(toolboxdir('vision'),'visiondata', ...  
    'calibration','stereo','left'));  
rightImages = imageDatastore(fullfile(toolboxdir('vision'),'visiondata', ...  
    'calibration','stereo','right'));
```

Detect the checkerboards.

```
[imagePoints,boardSize] = ...  
    detectCheckerboardPoints(leftImages.Files,rightImages.Files);
```

Specify the world coordinates of the checkerboard keypoints. Square size is in millimeters.

```
squareSize = 108;  
worldPoints = generateCheckerboardPoints(boardSize,squareSize);
```

Calibrate the stereo camera system. Both cameras have the same resolution.

```
I = readimage(leftImages,1);  
imageSize = [size(I,1),size(I,2)];
```

```
params = estimateCameraParameters(imagePoints,worldPoints, ...  
                                'ImageSize',imageSize);
```

Visualize the calibration accuracy.

```
showReprojectionErrors(params);
```

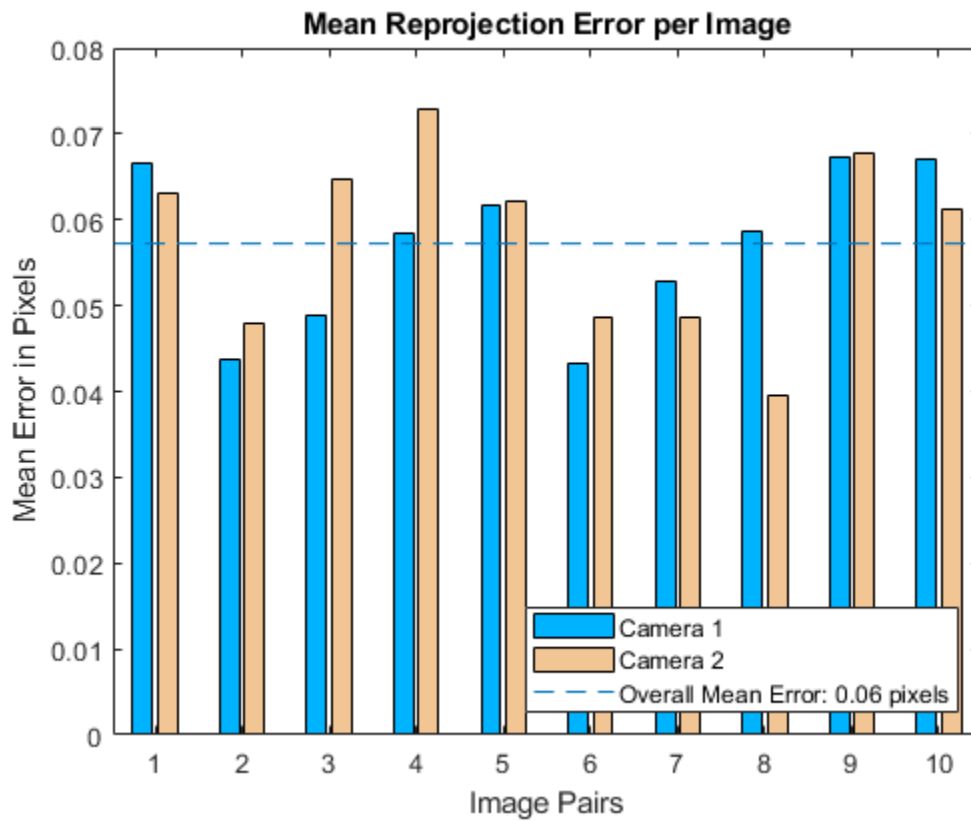

Visualize camera extrinsics.

```
figure;  
showExtrinsics(params);
```

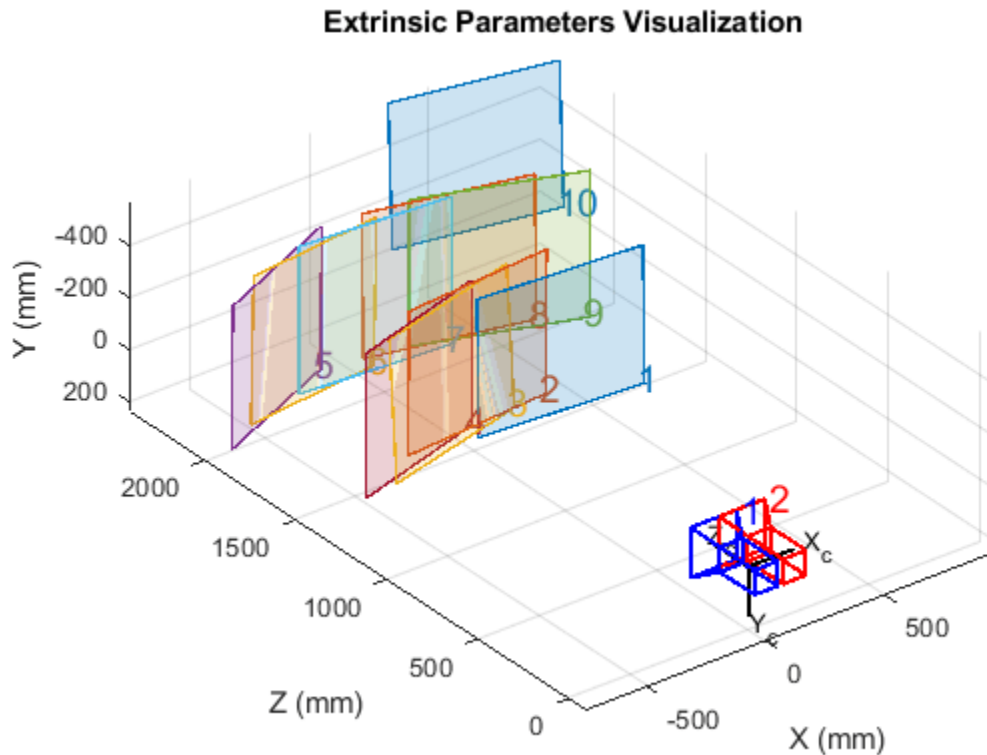

References

- [1] Zhang, Z. "A Flexible New Technique for Camera Calibration". *IEEE Transactions on Pattern Analysis and Machine Intelligence*. Vol. 22, No. 11, 2000, pp. 1330-1334.
- [2] Heikkila, J, and O. Silven. "A Four-step Camera Calibration Procedure with Implicit Image Correction." *IEEE International Conference on Computer Vision and Pattern Recognition*. 1997.

Extended Capabilities

C/C++ Code Generation

Generate C and C++ code using MATLAB® Coder™.

Usage notes and limitations:

- Use the `toStruct` method to pass a `stereoParameters` object into generated code. See the "Code Generation for Depth Estimation From Stereo Video" example.

See Also

Apps

Camera Calibrator | Stereo Camera Calibrator

Objects

stereoCalibrationErrors | intrinsicsEstimationErrors |
extrinsicsEstimationErrors | cameraParameters | rigid3d

Functions

estimateCameraParameters | showReprojectionErrors | showExtrinsics |
undistortImage | undistortPoints | detectCheckerboardPoints |
generateCheckerboardPoints | reconstructScene | rectifyStereoImages |
estimateFundamentalMatrix

Topics

“Structure From Motion From Two Views”
“Structure From Motion From Multiple Views”
“Code Generation for Depth Estimation From Stereo Video”
“Using the Single Camera Calibrator App”
“Using the Stereo Camera Calibrator App”
“Import Stereo Camera Parameters from ROS”

Introduced in R2014a

toStruct

Convert a stereo parameters object into a struct

Syntax

```
paramStruct = toStruct(stereoParams)
```

Description

`paramStruct = toStruct(stereoParams)` returns a struct containing the stereo parameters in the `stereoParams` input object. You can use the struct to create an identical `stereoParameters` object. Use the struct for C code generation. You can call `toStruct`, and then pass the resulting structure into the generated code, which recreates the `stereoParameters` object.

Input Arguments

stereoParams — Stereo parameters

`stereoParameters` object

Stereo parameters, specified as a `stereoParameters` object. The object contains the parameters of the stereo camera system.

Output Arguments

paramStruct — Stereo parameters

struct

Stereo parameters, returned as a stereo parameters struct.

See Also

Topics

“Code Generation for Depth Estimation From Stereo Video”

Introduced in R2015a

vision.TemplateMatcher

Package: vision

Locate template in image

Description

To locate a template in an image.

- 1 Create the `vision.TemplateMatcher` object and set its properties.
- 2 Call the object with arguments, as if it were a function.

To learn more about how System objects work, see [What Are System Objects?](#)

Creation

Syntax

```
tMatcher = vision.TemplateMatcher
tMatcher = vision.TemplateMatcher(Name,Value)
```

Description

`tMatcher = vision.TemplateMatcher` returns a template matcher object, `tMatcher`. This object performs template matching by shifting a template in single-pixel increments throughout the interior of an image.

`tMatcher = vision.TemplateMatcher(Name,Value)` sets properties using one or more name-value pairs. Enclose each property name in quotes. For example, `tMatcher = vision.TemplateMatcher('Metric','Sum of absolute differences')`

Properties

Unless otherwise indicated, properties are *nontunable*, which means you cannot change their values after calling the object. Objects lock when you call them, and the `release` function unlocks them.

If a property is *tunable*, you can change its value at any time.

For more information on changing property values, see [System Design in MATLAB Using System Objects](#).

Metric — Metric used for template matching source

```
'Sum of absolute differences' (default) | 'Sum of squared differences' | 'Maximum absolute difference'
```

Metric used for template matching, specified as `'Sum of absolute differences'`, `'Sum of squared differences'`, or `'Maximum absolute difference'`.

OutputValue — Type of output`'Best match location' (default) | 'Metric matrix'`

Type of output, specified as 'Metric matrix' or 'Best match location'.

SearchMethod — Specify search criteria to find minimum difference between two inputs`'Exhaustive' (default) | 'Three-step'`

Specify search criteria to find minimum difference between two inputs, specified as 'Exhaustive' or 'Three-step'. If you set this property to 'Exhaustive', the object searches for the minimum difference pixel by pixel. If you set this property to 'Three-step', the object searches for the minimum difference using a steadily decreasing step size. The 'Three-step' method is computationally less expensive than the 'Exhaustive' method, but sometimes does not find the optimal solution. This property applies when you set the OutputValue property to 'Best match location'.

BestMatchNeighborhoodOutputPort — Enable metric values output`false (default) | true`

Enable metric values output, specified as true or false. This property applies when you set the OutputValue property to 'Best match location'.

NeighborhoodSize — Size of the metric values`3 (default) | odd number`

Size of the metric values, specified as an odd number. The size N , of the N -by- N matrix of metric values as an odd number. For example, if the matrix size is 3-by-3 set this property to 3. This property applies when you set the OutputValue property to 'Best match location' and the BestMatchNeighborhoodOutputPort property to true.

ROIInputPort — Enable ROI specification through input`false (default) | true`

Enable ROI specification through input, specified as true or false. Set this property to true to define the Region of Interest (ROI) over which to perform the template matching. If you set this property to true, the ROI must be specified. Otherwise the entire input image is used.

ROIValidityOutputPort — Enable output of a flag indicating if any part of ROI is outside input image`false (default) | true`

Enable output of a flag indicating if any part of ROI is outside input image, specified as true or false. When you set this property to true, the object returns an ROI flag. The flag, when set to false, indicates a part of the ROI is outside of the input image. This property applies when you set the ROIInputPort property to true

Fixed-Point Properties**RoundingMethod — Rounding method for fixed-point operations**`'Floor' (default) | 'Ceiling' | 'Convergent' | 'Nearest' | 'Round' | 'Simplest' | 'Zero'`

Rounding method for fixed-point operations, specified as 'Floor', 'Ceiling', 'Convergent', 'Nearest', 'Round', 'Simplest', or 'Zero'.

OverflowAction — Action to take when integer input is out-of-range`'Wrap'` (default) | `'Saturate'`

Action to take when integer input is out-of-range, specified as `'Wrap'` or `'Saturate'`.

ProductDataType — Product data type`'Same as input'` (default) | `'Custom'`

Product data type, specified as `'Same as input'` or `'Custom'`.

CustomProductDataType — Product word and fraction lengths`numericType(true,32,30)` (default) | scaled `numericType` object

Product word and fraction lengths, specified as a scaled `numericType` object. This property applies only when you set the `AccumulatorDataType` property to `'Custom'`.

AccumulatorDataType — Data type of accumulator`'Same as product'` (default) | `'Same as input'` | `'Custom'`

Data type of accumulator, specified as `'Same as product'`, `'Same as input'`, or `'Custom'`.

CustomAccumulatorDataType — Accumulator word and fraction lengths`numericType(true,32,30)` (default) | scaled `numericType` object

Accumulator word and fraction lengths, specified as a scaled `numericType` object. This property applies only when you set the `AccumulatorDataType` property to `'Custom'`.

Usage

Syntax

```
location = tMatcher(I,T)
```

```
[location,numberOfValues,numValid] = tMatcher(I,T,ROI)
```

```
[location,numberOfValues,numValid,ROIInvalid] = tMatcher(I,T,ROI)
```

```
[location,ROIInvalid] = tMatcher(I,T,ROI)
```

Description

`location = tMatcher(I,T)` returns the `[x y]` location coordinates of the best template match relative to the top left corner of the image between the image matrix, `I`, and the template matrix, `T`. The object computes the location by shifting the template in single-pixel increments throughout the interior of the image.

`[location,numberOfValues,numValid] = tMatcher(I,T,ROI)` returns the location of the best template match `location`, the metric values around the best match `numberOfValues`, and a logical flag `numValid`. This applies when you set the `OutputValue` property to `'Best match location'` and the `BestMatchNeighborhoodOutputPort` property to `true`.

`[location,numberOfValues,numValid,ROIInvalid] = tMatcher(I,T,ROI)` also returns a logical flag, `ROIInvalid` to indicate whether the ROI is outside the bounds of the input image `I`. This applies when you set the `OutputValue` property to `'Best match location'`, and the `BestMatchNeighborhoodOutputPort`, `ROIInputPort`, and `ROIValidityOutputPort` properties to `true`.

[location,R0Invalid] = tMatcher(I,T,ROI) also returns a logical flag R0Invalid indicating if the specified ROI is outside the bounds of the input image I. This applies when you set the OutputValue property to 'Best match location', and both the ROIInputPort and ROIValidityOutputPort properties to true.

Input Arguments

I – Input image

truecolor | *M*-by-*N* 2-D grayscale image

Input image, specified as either a 2-D grayscale or truecolor image.

T – Template

binary image | truecolor | *M*-by-*N* 2-D grayscale image

Input template, specified as 2-D grayscale or truecolor image.

ROI – Input ROI

four-element vector

Input ROI, specified as a four-element vector, [*x* *y* *width* *height*], where the first two elements represent the coordinates of the upper-left corner of the rectangular ROI.

Output Arguments

location – Location of best template match

vector

Location of best template match, returned as a vector in the format (*x*,*y*). The coordinates indicate the center of the template relative to the top-left corner of the image. For more details, see “Algorithms” on page 2-715

numberOfValues – Metric value

matrix

Metric value matrix, returned as a matrix. A false value for numValid indicates that the neighborhood around the best match extended outside the borders of the metric value matrix numberOfValues.

numValid – Valid neighborhood

true | false

Valid neighborhood, returned as true or false. A false value for numValid indicates that the neighborhood around the best match extended outside the borders of the metric value matrix numberOfValues.

R0Invalid – Valid ROI

true | false

Valid ROI neighborhood, returned as true or false. A false value for R0Invalid indicates that the ROI is outside the bounds of the input image.

Object Functions

To use an object function, specify the System object as the first input argument. For example, to release system resources of a System object named `obj`, use this syntax:

```
release(obj)
```

Common to All System Objects

<code>step</code>	Run System object algorithm
<code>release</code>	Release resources and allow changes to System object property values and input characteristics
<code>reset</code>	Reset internal states of System object

Examples

Video Stabilization

This example shows how to remove the effect of camera motion from a video stream.

Introduction

In this example we first define the target to track. In this case, it is the back of a car and the license plate. We also establish a dynamic search region, whose position is determined by the last known target location. We then search for the target only within this search region, which reduces the number of computations required to find the target. In each subsequent video frame, we determine how much the target has moved relative to the previous frame. We use this information to remove unwanted translational camera motions and generate a stabilized video.

Initialization

Create a System object™ to read video from a multimedia file. We set the output to be of intensity only video.

```
% Input video file which needs to be stabilized.
filename = 'shaky_car.avi';
```

```
hVideoSource = VideoReader(filename);
```

Create a template matcher System object to compute the location of the best match of the target in the video frame. We use this location to find translation between successive video frames.

```
hTM = vision.TemplateMatcher('ROIInputPort', true, ...
                             'BestMatchNeighborhoodOutputPort', true);
```

Create a System object to display the original video and the stabilized video.

```
hVideoOut = vision.VideoPlayer('Name', 'Video Stabilization');
hVideoOut.Position(1) = round(0.4*hVideoOut.Position(1));
hVideoOut.Position(2) = round(1.5*(hVideoOut.Position(2)));
hVideoOut.Position(3:4) = [650 350];
```

Here we initialize some variables used in the processing loop.

```
pos.template_orig = [109 100]; % [x y] upper left corner
pos.template_size = [22 18];  % [width height]
```

```

pos.search_border = [15 10]; % max horizontal and vertical displacement
pos.template_center = floor((pos.template_size-1)/2);
pos.template_center_pos = (pos.template_orig + pos.template_center - 1);
W = hVideoSource.Width; % Width in pixels
H = hVideoSource.Height; % Height in pixels
BorderCols = [1:pos.search_border(1)+4 W-pos.search_border(1)+4:W];
BorderRows = [1:pos.search_border(2)+4 H-pos.search_border(2)+4:H];
sz = [W, H];
TargetRowIndices = ...
    pos.template_orig(2)-1:pos.template_orig(2)+pos.template_size(2)-2;
TargetColIndices = ...
    pos.template_orig(1)-1:pos.template_orig(1)+pos.template_size(1)-2;
SearchRegion = pos.template_orig - pos.search_border - 1;
Offset = [0 0];
Target = zeros(18,22);
firstTime = true;

```

Stream Processing Loop

This is the main processing loop which uses the objects we instantiated above to stabilize the input video.

```

while hasFrame(hVideoSource)
    input = rgb2gray(im2double(readFrame(hVideoSource)));

    % Find location of Target in the input video frame
    if firstTime
        Idx = int32(pos.template_center_pos);
        MotionVector = [0 0];
        firstTime = false;
    else
        IdxPrev = Idx;

        ROI = [SearchRegion, pos.template_size+2*pos.search_border];
        Idx = hTM(input,Target,ROI);

        MotionVector = double(Idx-IdxPrev);
    end

    [Offset, SearchRegion] = updatesearch(sz, MotionVector, ...
        SearchRegion, Offset, pos);

    % Translate video frame to offset the camera motion
    Stabilized = imtranslate(input, Offset, 'linear');

    Target = Stabilized(TargetRowIndices, TargetColIndices);

    % Add black border for display
    Stabilized(:, BorderCols) = 0;
    Stabilized(BorderRows, :) = 0;

    TargetRect = [pos.template_orig-Offset, pos.template_size];
    SearchRegionRect = [SearchRegion, pos.template_size + 2*pos.search_border];

    % Draw rectangles on input to show target and search region
    input = insertShape(input, 'Rectangle', [TargetRect; SearchRegionRect], ...
        'Color', 'white');
    % Display the offset (displacement) values on the input image

```

```

txt = sprintf('%+05.1f,%+05.1f', Offset);
input = insertText(input(:,:,1),[191 215],txt,'FontSize',16, ...
    'TextColor', 'white', 'BoxOpacity', 0);
% Display video
hVideoOut([input(:,:,1) Stabilized]);
end

```

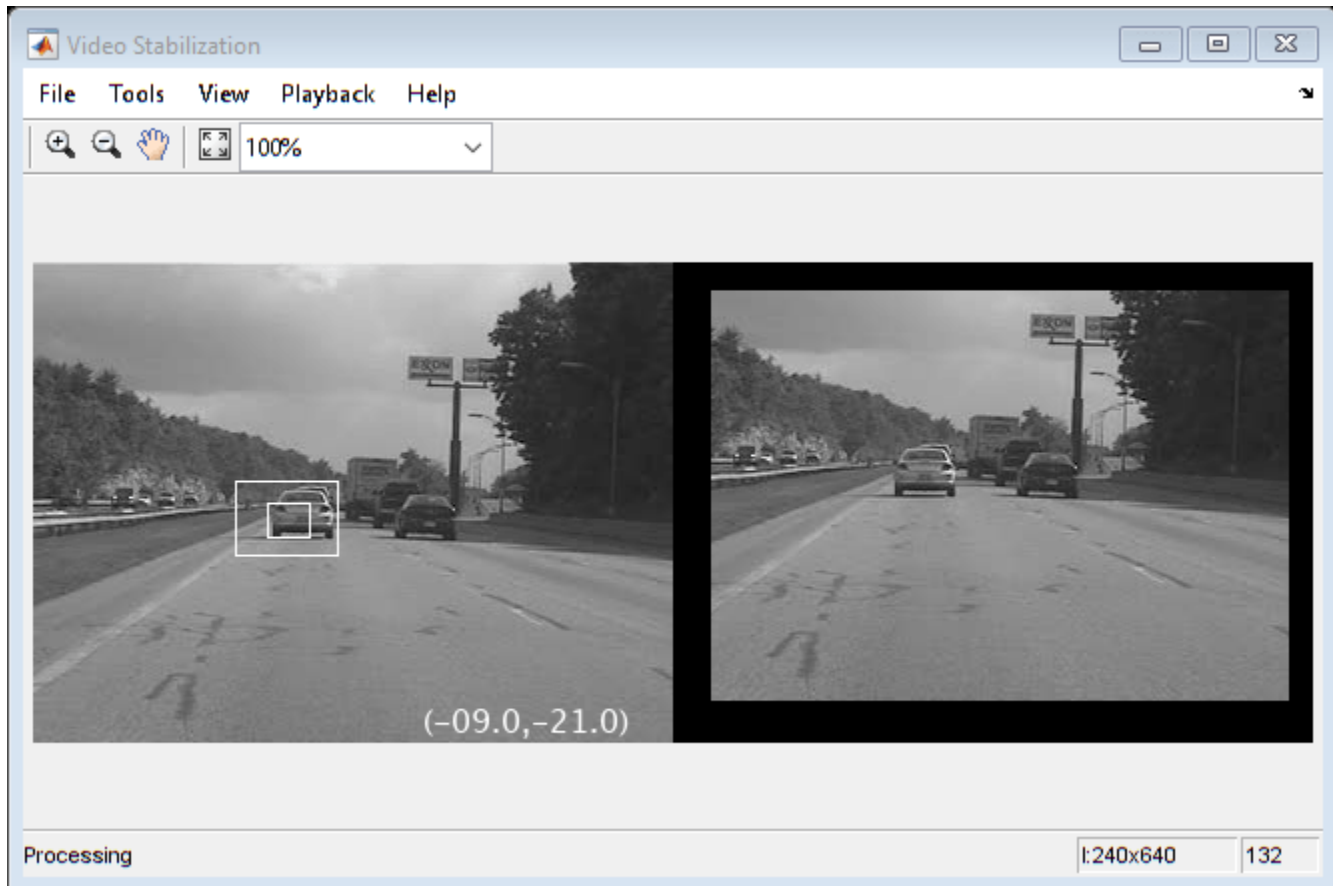

Conclusion

Using the Computer Vision Toolbox™ functionality from MATLAB® command line it is easy to implement complex systems like video stabilization.

Appendix

The following helper function is used in this example.

- updatesearch.m

Algorithms

Typical use of the template matcher involves finding a small region within a larger image. The region is specified by the template image which can be as large as the input image, but which is typically smaller than the input image.

The object outputs the best match coordinates, relative to the top-left corner of the image. The $[x\ y]$ coordinates of the location correspond to the center of the template. When you use a template with

an odd number of pixels, the object uses the center of the template. When you use a template with an even number of pixels, the object uses the centered upper-left pixel for the location. The following table shows how the object outputs the location (LOC), of odd and even templates:

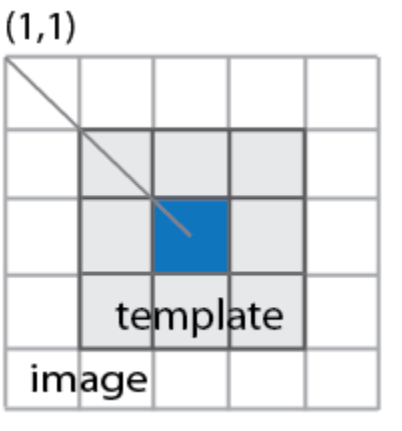
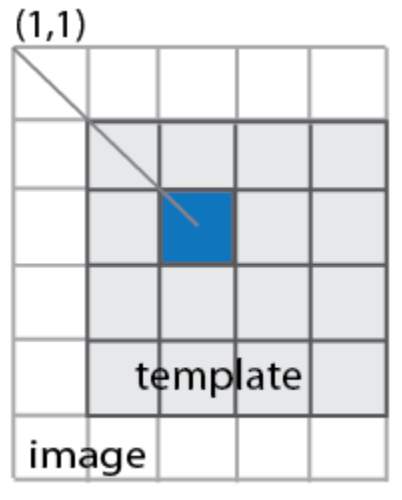
Odd number of pixels in template	Even number of pixels in template
	

Extended Capabilities

C/C++ Code Generation

Generate C and C++ code using MATLAB® Coder™.

Usage notes and limitations:

- See “System Objects in MATLAB Code Generation” (MATLAB Coder).

See Also

`opticalFlowHS` | `opticalFlowLKDoG` | `opticalFlowLK` | `opticalFlowFarneback` | `insertMarker`

Introduced in R2012a

vision.Variance

Package: vision

Find variance values in input or sequence of inputs

Description

Find the variance values in an input or sequence of inputs.

To track a set of points:

- 1 Create the `vision.Variance` object and set its properties.
- 2 Call the object with arguments, as if it were a function.

To learn more about how System objects work, see [What Are System Objects?](#)

Creation

Syntax

```
varObj = vision.Variance
varObj = vision.Variance(Name,Value)
```

Description

`varObj = vision.Variance` returns an object, `varObj`, that computes the value and index of the maximum elements in an input or a sequence of inputs.

`varObj = vision.Variance(Name,Value)` sets properties using one or more name-value pairs. Enclose each property name in quotes. For example, `varObj = vision.Variance('RunningVariance', false)`

Properties

Unless otherwise indicated, properties are *nontunable*, which means you cannot change their values after calling the object. Objects lock when you call them, and the `release` function unlocks them.

If a property is *tunable*, you can change its value at any time.

For more information on changing property values, see [System Design in MATLAB Using System Objects](#).

RunningVariance — Calculate over single input or multiple inputs

`false` (default) | `true`

Calculate over single input or multiple inputs, specified as `true` or `false`. When you set this property to `true`, the object computes the variance value over a sequence of inputs. When you set this property to `false`, the object computes the variance value over the current input.

ResetInputPort — Additional input to enable resetting of running variance`false` (default) | `true`

Additional input to enable resetting of running variance, specified as `true` or `false`. When you set this property to `true`, a reset input must be specified to reset the running variance. This property applies only when you set the `RunningVariance` property to `true`.

ResetCondition — Condition that triggers resetting of running variance`'Non-zero'` (default) | `'Rising edge'` | `'Falling edge'` | `'Either edge'`

Condition that triggers resetting of running variance, specified as `'Rising edge'`, `'Falling edge'`, `'Either edge'`, or `'Non-zero'`. This property applies only when you set the `ResetInputPort` property to `true`.

Dimension — Dimension to operate along`'Column'` (default) | `{'All'}` | `'Row'` | `'Custom'`

Dimension to operate along, specified as `{'All'}`, `'Row'`, `'Column'`, or `'Custom'`. This property applies only when you set the `RunningVariance` property to `false`.

CustomDimension — Numerical dimension to calculate over`1` (default) | numerical scalar

Numerical dimension to calculate over, specified as a numerical scalar. This property only applies when you set the `Dimension` property to `'Custom'`.

ROIProcessing — Enable region-of-interest processing`false` (default) | `true`

Enable region-of-interest processing, specified as `true` or `false`. This property applies when you set the `Dimension` property to `'All'` and the `RunningVariance` property to `false`.

ROIForm — Type of ROI`'Rectangles'` (default) | `'Lines'` | `'Label matrix'` | `'Binary mask'`

Type of ROI, specified as `'Rectangles'`, `'Lines'`, `'Label matrix'`, or `'Binary mask'`. This property applies only when you set the `ROIProcessing` property to `true`.

ROIStatistics — Calculate statistics for each ROI or one for all ROIs`'Individual statistics for each ROI'` (default) | `'Single statistic for all ROIs'`

Calculate statistics for each ROI or one for all ROIs, specified as `'Individual statistics for each ROI'` or `'Single statistic for all ROIs'`. This property applies only when you set the `ROIForm` property to `'Rectangles'`, `'Lines'`, or `'Label matrix'`.

ValidityOutputPort — Flag to indicate if any part of ROI is outside input image`false` (default) | `true`

Flag to indicate if any part of ROI is outside input image, specified as `true` or `false`.

This applies when you set the `ROIForm` property to `'Lines'` or `'Rectangles'`.

Set this property to `true` to return the validity of the specified label numbers. This applies when you set the `ROIForm` property to `'Label matrix'`.

Fixed-Point Properties

RoundingMethod — Rounding method for fixed-point operations

'Floor' (default) | 'Ceiling' | 'Convergent' | 'Nearest' | 'Round' | 'Simplest' | 'Zero'

Rounding method for fixed-point operations, specified as 'Floor', 'Ceiling', 'Convergent', 'Nearest', 'Round', 'Simplest', or 'Zero'.

OverflowAction — Action to take when integer input is out-of-range

'Wrap' (default) | 'Saturate'

Action to take when integer input is out-of-range, specified as 'Wrap' or 'Saturate'.

ProductDataType — Product data type

'Same as input' (default) | 'Custom'

Product data type, specified as 'Same as input' or 'Custom'.

CustomProductDataType — Product word and fraction lengths

numericType(true,32,30) (default) | scaled numericType object

Product word and fraction lengths, specified as a scaled numericType object. This property applies only when you set the AccumulatorDataType property to 'Custom'.

AccumulatorDataType — Data type of accumulator

'Same as product' (default) | 'Same as input' | 'Custom'

Data type of accumulator, specified as 'Same as product', 'Same as input', or 'Custom'.

CustomAccumulatorDataType — Accumulator word and fraction lengths

numericType(true,32,30) (default) | scaled numericType object

Accumulator word and fraction lengths, specified as a scaled numericType object. This property applies only when you set the AccumulatorDataType property to 'Custom'.

Usage

Syntax

```
[value,index] = varObj(input)
index = varObj(input)
```

```
[ ___ ] = varObj(I,ROI)
[ ___ ,flag] = varObj(I,ROI)
```

```
[ ___ ] = varObj(I,label,labelNumbers)
[ ___ ,flag] = varObj(I,label,labelNumbers)
```

Description

[value,index] = varObj(input) returns the variance value and index of the input.

index = varObj(input) returns the one-based index of the variance value when you set the IndexOutputPort property to true and the ValueOutputPort property to false. The RunningVariance property must be set to false.

[___] = varObj (I , ROI) returns the variance value in the input image within the given region of interest.

[___ , flag] = varObj (I , ROI) additionally returns a flag to indicate whether the given ROI is within the bounds of the image.

[___] = varObj (I , label , labelNumbers) returns the variance of the input image for a region the labels specified in the labelNumbers vector. The regions are defined and labeled in the label matrix.

[___ , flag] = varObj (I , label , labelNumbers) additionally returns a flag to indicate whether the input label numbers are valid.

Input Arguments

input — Input data

vector | matrix | multidimensional array

Input data, specified as a vector, matrix, or multidimensional array.

ROI — Region of interest

four-element vector

Region of interest, specified as a four-element vector, [x y width height]. This option is available when you set the ROIProcessing property to true and the ROIForm property to 'Lines', 'Rectangles', or 'Binary Mask'.

label — Label numbers

matrix

Label numbers, specified as a matrix. This option is available when you set the ROIProcessing property to true and the ROIForm property to 'Label matrix'.

labelNumbers — Label numbers

vector

Label numbers, specified as a vector. This option is available when you set the ROIProcessing property to true and the ROIForm property to 'Label matrix'.

Output Arguments

value — Variance value

same as input

Variance value, returned as the same data type as the input

index — Index to variance value

one-based index

Index to variance value, returned as a one-based index.

flag — Flag for valid data

true | false

Flag for valid data, returned as true or false.

Object Functions

To use an object function, specify the System object as the first input argument. For example, to release system resources of a System object named `obj`, use this syntax:

```
release(obj)
```

Common to All System Objects

<code>step</code>	Run System object algorithm
<code>release</code>	Release resources and allow changes to System object property values and input characteristics
<code>reset</code>	Reset internal states of System object

Examples

Determine Variance in Grayscale Image

Read a color image.

```
img = imread('peppers.png');
```

Convert the image to grayscale.

```
img = im2single(rgb2gray(img));
```

Find the variance.

```
varObj = vision.Variance;  
varValue = varObj(img);
```

Extended Capabilities

C/C++ Code Generation

Generate C and C++ code using MATLAB® Coder™.

Usage notes and limitations:

- See “System Objects in MATLAB Code Generation” (MATLAB Coder).

See Also

`vision.Maximum` | `vision.Mean` | `vision.Minimum` | `vision.Median` | `vision.StandardDeviation`

Introduced in R2012a

vision.VideoPlayer

Package: vision

Play video or display image

Description

Play a video or display image sequences.

Note If you own the MATLAB Coder product, you can generate C or C++ code from MATLAB code in which an instance of this system object is created. When you do so, the scope system object is automatically declared as an extrinsic variable. In this manner, you are able to see the scope display in the same way that you would see a figure using the `plot` function, without directly generating code from it. For the full list of system objects supporting code generation, see Code Generation Support, Usage Notes, and Limitations.

Note Starting in R2016b, instead of using the `step` method to perform the operation defined by the System object, you can call the object with arguments, as if it were a function. For example, `y = step(obj,x)` and `y = obj(x)` perform equivalent operations.

Creation

Syntax

```
videoPlayer = vision.VideoPlayer  
videoPlayer = vision.VideoPlayer( ___,Name,Value)
```

Description

`videoPlayer = vision.VideoPlayer` returns a video player object, `videoPlayer`, for displaying video frames.

`videoPlayer = vision.VideoPlayer(___,Name,Value)` additionally sets properties using one or more name-value pairs. Enclose each property name in quotes. For example, `videoPlayer = vision.VideoPlayer('Name','Caption title')`

Properties

Name — Caption display on video player window

Video (default) | character vector

Caption display on video player window, specified as a character vector.

Tunable: Yes

Position — Size and position of the video player window in pixels

four-element vector

Size and position of the video player window in pixels, specified as a four-element vector, [`left` `bottom` `width` `height`]. The default size depends on your screen resolution. The window is positioned in the center of the screen, 400 pixels in width by 300 pixels in height.

Tunable: Yes

Usage

Syntax

```
videoPlayer(videoFrame)
```

Description

`videoPlayer(videoFrame)` displays one grayscale or truecolor RGB video frame, `videoFrame`, in the video player.

Input Arguments

videoFrame — Video frame

truecolor | 2-D grayscale image

Video frame, specified as a truecolor or 2-D grayscale image.

Object Functions

To use an object function, specify the System object as the first input argument. For example, to release system resources of a System object named `obj`, use this syntax:

```
release(obj)
```

Common to All System Objects

<code>step</code>	Run System object algorithm
<code>release</code>	Release resources and allow changes to System object property values and input characteristics
<code>reset</code>	Reset internal states of System object

Examples

Play a Video File

Read video from a file and set up player object.

```
videoReader = VideoReader('viplanedeparture.mp4');
videoPlayer = vision.VideoPlayer;
```

Play video. Every call to the `step` method reads another frame.

```
while hasFrame(videoReader)
    frame = readFrame(videoReader);
    step(videoPlayer, frame);
end
```

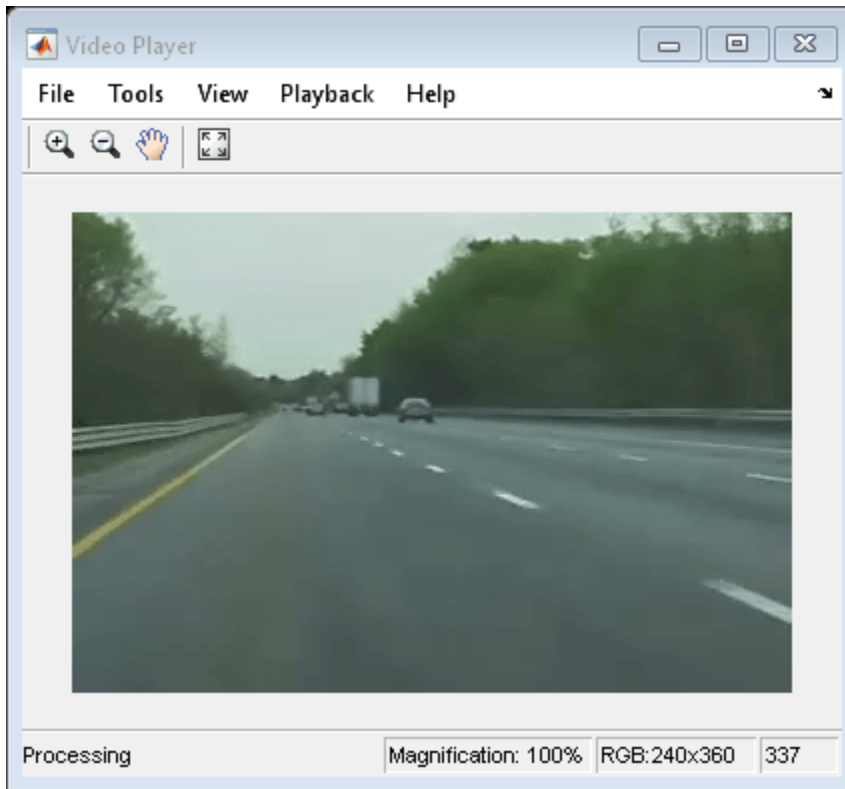

Close the video player.

```
release(videoPlayer);
```

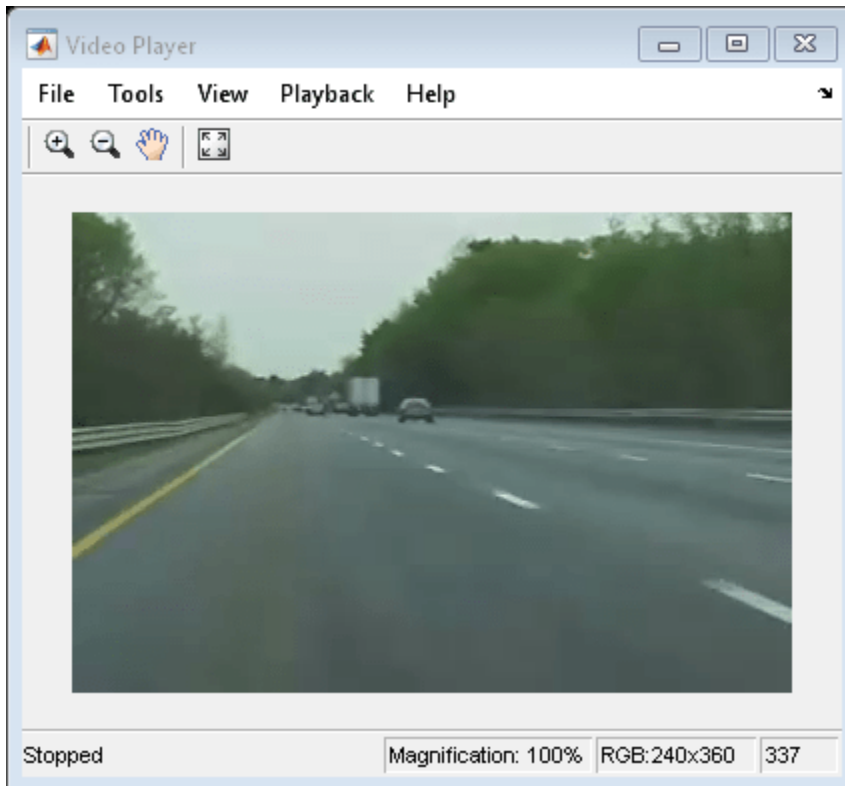
See Also

[vision.DeployableVideoPlayer](#) | [vision.VideoFileReader](#) | [vision.VideoFileWriter](#) | [imshow](#) | **Video Viewer**

Topics

[“Face Detection and Tracking Using CAMShift”](#)
[“Face Detection and Tracking Using the KLT Algorithm”](#)
[“Face Detection and Tracking Using Live Video Acquisition”](#)
[“Video Display in a Custom User Interface”](#)

Introduced in R2012a

fastRCNNObjectDetector

Detect objects using Fast R-CNN deep learning detector

Description

The `fastRCNNObjectDetector` object detects objects from an image, using a Fast R-CNN (regions with convolution neural networks) object detector. To detect objects in an image, pass the trained detector to the `detect` function. To classify image regions, pass the detector to the `classifyRegions` function.

When using the `detect` or `classifyRegions` functions with `fastRCNNObjectDetector`, use of a CUDA enabled NVIDIA GPU is highly recommended. The GPU reduces computation time significantly. Usage of the GPU requires Parallel Computing Toolbox. For information about the supported compute capabilities, see “GPU Support by Release” (Parallel Computing Toolbox).

Creation

Create a `fastRCNNObjectDetector` object by calling the `trainFastRCNNObjectDetector` function with training data (requires Deep Learning Toolbox).

```
detector = trainFastRCNNObjectDetector(trainingData,...)
```

Properties

modelName — Name of classification model

character vector | string scalar

Name of the classification model, specified as a character vector or string scalar. By default, the name is set to the heading of the second column of the `trainingData` table specified in the `trainFastRCNNObjectDetector` function. You can modify this name after creating your `fastRCNNObjectDetector` object.

Example: 'stopSign'

network — Trained Fast R-CNN object detection network

object

This property is read-only.

Trained Fast R-CNN detection network, specified as an object. This object stores the layers that define the convolutional neural network used within the Fast R-CNN detector. This network classifies region proposals produced by the `RegionProposalFcn` property.

RegionProposalFcn — Region proposal method

function handle

Region proposal method, specified as a function handle.

ClassNames — Object class names

cell array

This property is read-only.

Names of the object classes that the Fast R-CNN detector was trained to find, specified as a cell array. This property is set by the `trainingData` input argument for the `trainFastRCNNObjectDetector` function. Specify the class names as part of the `trainingData` table.

MinObjectSize — Minimum object size supported

[height width] vector

This property is read-only.

Minimum object size supported by the Fast R-CNN network, specified as a *[height width]* vector. The minimum size depends on the network architecture.

Object Functions

`detect` Detect objects using Fast R-CNN object detector
`classifyRegions` Classify objects in image regions using Fast R-CNN object detector

Examples**Detect Vehicles Using Faster R-CNN**

Detect vehicles within an image by using a Faster R-CNN object detector.

Load a Faster R-CNN object detector pretrained to detect vehicles.

```
data = load('fasterRCNNVehicleTrainingData.mat', 'detector');  
detector = data.detector;
```

Read in a test image.

```
I = imread('highway.png');  
imshow(I)
```



Run the detector on the image and inspect the results. The labels come from the `ClassNames` property of the detector.

```
[bboxes,scores,labels] = detect(detector,I)
```

```
bboxes = 2x4
```

```
    150    86    80    72  
     91    89    67    48
```

```
scores = 2x1 single column vector
```

```
    1.0000  
    0.9001
```

```
labels = 2x1 categorical
```

```
    vehicle  
    vehicle
```

The detector has high confidence in the detections. Annotate the image with the bounding boxes for the detections and the corresponding detection scores.

```
detectedI = insertObjectAnnotation(I, 'Rectangle',bboxes,cellstr(labels));  
figure  
imshow(detectedI)
```

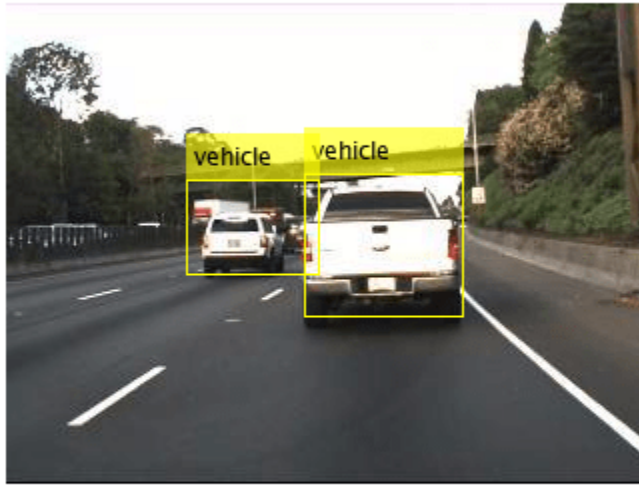

See Also

Apps

[Image Labeler](#) | [Video Labeler](#)

Functions

[trainFastRCNNObjectDetector](#) | [trainFasterRCNNObjectDetector](#) |
[trainACFObjectDetector](#) | [trainNetwork](#) | [selectStrongestBboxMulticlass](#)

Objects

[SeriesNetwork](#) | [boxLabelDatastore](#)

Topics

“Getting Started with R-CNN, Fast R-CNN, and Faster R-CNN”
“Datastores for Deep Learning” (Deep Learning Toolbox)

Introduced in R2017a

fasterRCNNObjectDetector

Detect objects using Faster R-CNN deep learning detector

Description

The `fasterRCNNObjectDetector` object detects objects from an image, using a Faster R-CNN (regions with convolution neural networks) object detector. To detect objects in an image, pass the trained detector to the `detect` function.

When using the `detect` function, use of a CUDA enabled NVIDIA GPU is highly recommended. The GPU reduces computation time significantly. Usage of the GPU requires Parallel Computing Toolbox. For information about the supported compute capabilities, see “GPU Support by Release” (Parallel Computing Toolbox).

Creation

Create a `fasterRCNNObjectDetector` object by calling the `trainFasterRCNNObjectDetector` function with training data (requires Deep Learning Toolbox).

```
detector = trainFasterRCNNObjectDetector(trainingData,...)
```

Properties

ModelName — Name of classification model

character vector | string scalar

This property is read-only.

Name of the classification model, specified as a character vector or string scalar. By default, the name is set to the heading of the second column of the `trainingData` table specified in the `trainFasterRCNNObjectDetector` function. You can modify this name after creating your `fasterRCNNObjectDetector` object.

Network — Trained Fast R-CNN object detection network

DAGNetwork object

This property is read-only.

Trained Fast R-CNN object detection network, specified as a `DAGNetwork` object. This object stores the layers that define the convolutional neural network used within the Faster R-CNN detector.

AnchorBoxes — Size of anchor boxes

M-by-2 matrix

This property is read-only.

Size of anchor boxes, specified as an *M*-by-2 matrix, where each row is in the format [*height width*]. This value is set during training.

ClassNames — Object class names

cell array

This property is read-only.

Names of the object classes that the Faster R-CNN detector was trained to find, specified as a cell array. This property is set by the `trainingData` input argument for the `trainFasterRCNNObjectDetector` function. Specify the class names as part of the `trainingData` table.

MinObjectSize — Minimum object size supported*[height width]* vector

This property is read-only.

Minimum object size supported by the Faster R-CNN network, specified as a *[height width]* vector. The minimum size depends on the network architecture.

Object Functions

`detect` Detect objects using Faster R-CNN object detector

Examples**Object Detection Using Faster R-CNN Deep Learning**

This example shows how to train a Faster R-CNN (regions with convolutional neural networks) object detector.

Deep learning is a powerful machine learning technique that you can use to train robust object detectors. Several deep learning techniques for object detection exist, including Faster R-CNN and you only look once (YOLO) v2. This example trains a Faster R-CNN vehicle detector using the `trainFasterRCNNObjectDetector` function. For more information, see “Object Detection”.

Download Pretrained Detector

Download a pretrained detector to avoid having to wait for training to complete. If you want to train the detector, set the `doTraining` variable to true.

```
doTraining = false;
if ~doTraining && ~exist('fasterRCNNResNet50EndToEndVehicleExample.mat','file')
    disp('Downloading pretrained detector (118 MB)...');
    pretrainedURL = 'https://www.mathworks.com/supportfiles/vision/data/fasterRCNNResNet50EndToE
    websave('fasterRCNNResNet50EndToEndVehicleExample.mat',pretrainedURL);
end
```

Load Data Set

This example uses a small labeled dataset that contains 295 images. Many of these images come from the Caltech Cars 1999 and 2001 data sets, available at the Caltech Computational Vision website, created by Pietro Perona and used with permission. Each image contains one or two labeled instances of a vehicle. A small dataset is useful for exploring the Faster R-CNN training procedure, but in practice, more labeled images are needed to train a robust detector. Unzip the vehicle images and load the vehicle ground truth data.

```
unzip vehicleDatasetImages.zip
data = load('vehicleDatasetGroundTruth.mat');
vehicleDataset = data.vehicleDataset;
```

The vehicle data is stored in a two-column table, where the first column contains the image file paths and the second column contains the vehicle bounding boxes.

Split the dataset into training, validation, and test sets. Select 60% of the data for training, 10% for validation, and the rest for testing the trained detector.

```
rng(0)
shuffledIndices = randperm(height(vehicleDataset));
idx = floor(0.6 * height(vehicleDataset));

trainingIdx = 1:idx;
trainingDataTbl = vehicleDataset(shuffledIndices(trainingIdx),:);

validationIdx = idx+1 : idx + 1 + floor(0.1 * length(shuffledIndices) );
validationDataTbl = vehicleDataset(shuffledIndices(validationIdx),:);

testIdx = validationIdx(end)+1 : length(shuffledIndices);
testDataTbl = vehicleDataset(shuffledIndices(testIdx),:);
```

Use `imageDatastore` and `boxLabelDatastore` to create datastores for loading the image and label data during training and evaluation.

```
imdsTrain = imageDatastore(trainingDataTbl{:, 'imageFilename'});
bldsTrain = boxLabelDatastore(trainingDataTbl(:, 'vehicle'));

imdsValidation = imageDatastore(validationDataTbl{:, 'imageFilename'});
bldsValidation = boxLabelDatastore(validationDataTbl(:, 'vehicle'));

imdsTest = imageDatastore(testDataTbl{:, 'imageFilename'});
bldsTest = boxLabelDatastore(testDataTbl(:, 'vehicle'));
```

Combine image and box label datastores.

```
trainingData = combine(imdsTrain,bldsTrain);
validationData = combine(imdsValidation,bldsValidation);
testData = combine(imdsTest,bldsTest);
```

Display one of the training images and box labels.

```
data = read(trainingData);
I = data{1};
bbox = data{2};
annotatedImage = insertShape(I, 'Rectangle', bbox);
annotatedImage = imresize(annotatedImage, 2);
figure
imshow(annotatedImage)
```

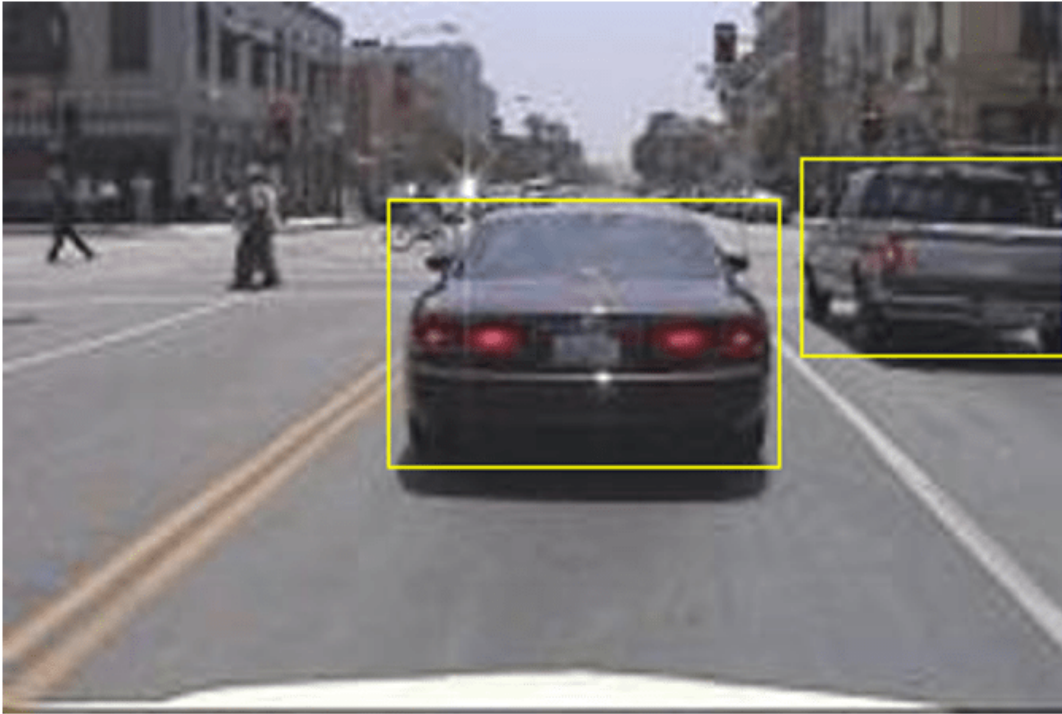
Create Faster R-CNN Detection Network

A Faster R-CNN object detection network is composed of a feature extraction network followed by two subnetworks. The feature extraction network is typically a pretrained CNN, such as ResNet-50 or Inception v3. The first subnetwork following the feature extraction network is a region proposal network (RPN) trained to generate object proposals - areas in the image where objects are likely to exist. The second subnetwork is trained to predict the actual class of each object proposal.

The feature extraction network is typically a pretrained CNN (for details, see “Pretrained Deep Neural Networks” (Deep Learning Toolbox)). This example uses ResNet-50 for feature extraction. You can also use other pretrained networks such as MobileNet v2 or ResNet-18, depending on your application requirements.

Use `fasterRCNNLayers` to create a Faster R-CNN network automatically given a pretrained feature extraction network. `fasterRCNNLayers` requires you to specify several inputs that parameterize a Faster R-CNN network:

- Network input size
- Anchor boxes
- Feature extraction network

First, specify the network input size. When choosing the network input size, consider the minimum size required to run the network itself, the size of the training images, and the computational cost incurred by processing data at the selected size. When feasible, choose a network input size that is close to the size of the training image and larger than the input size required for the network. To

reduce the computational cost of running the example, specify a network input size of [224 224 3], which is the minimum size required to run the network.

```
inputSize = [224 224 3];
```

Note that the training images used in this example are bigger than 224-by-224 and vary in size, so you must resize the images in a preprocessing step prior to training.

Next, use `estimateAnchorBoxes` to estimate anchor boxes based on the size of objects in the training data. To account for the resizing of the images prior to training, resize the training data for estimating anchor boxes. Use `transform` to preprocess the training data, then define the number of anchor boxes and estimate the anchor boxes.

```
preprocessedTrainingData = transform(trainingData, @(data)preprocessData(data,inputSize));  
numAnchors = 3;  
anchorBoxes = estimateAnchorBoxes(preprocessedTrainingData,numAnchors)
```

```
anchorBoxes = 3×2
```

```
    29    17  
    46    39  
   136   116
```

For more information on choosing anchor boxes, see “Estimate Anchor Boxes From Training Data” (Computer Vision Toolbox™) and “Anchor Boxes for Object Detection”.

Now, use `resnet50` to load a pretrained ResNet-50 model.

```
featureExtractionNetwork = resnet50;
```

Select `'activation_40_relu'` as the feature extraction layer. This feature extraction layer outputs feature maps that are downsampled by a factor of 16. This amount of downsampling is a good trade-off between spatial resolution and the strength of the extracted features, as features extracted further down the network encode stronger image features at the cost of spatial resolution. Choosing the optimal feature extraction layer requires empirical analysis. You can use `analyzeNetwork` to find the names of other potential feature extraction layers within a network.

```
featureLayer = 'activation_40_relu';
```

Define the number of classes to detect.

```
numClasses = width(vehicleDataset)-1;
```

Create the Faster R-CNN object detection network.

```
lgraph = fasterRCNNLayers(inputSize,numClasses,anchorBoxes,featureExtractionNetwork,featureLayer);
```

You can visualize the network using `analyzeNetwork` or Deep Network Designer from Deep Learning Toolbox™.

If more control is required over the Faster R-CNN network architecture, use Deep Network Designer to design the Faster R-CNN detection network manually. For more information, see “Getting Started with R-CNN, Fast R-CNN, and Faster R-CNN”.

Data Augmentation

Data augmentation is used to improve network accuracy by randomly transforming the original data during training. By using data augmentation, you can add more variety to the training data without actually having to increase the number of labeled training samples.

Use `transform` to augment the training data by randomly flipping the image and associated box labels horizontally. Note that data augmentation is not applied to test and validation data. Ideally, test and validation data are representative of the original data and are left unmodified for unbiased evaluation.

```
augmentedTrainingData = transform(trainingData,@augmentData);
```

Read the same image multiple times and display the augmented training data.

```
augmentedData = cell(4,1);
for k = 1:4
    data = read(augmentedTrainingData);
    augmentedData{k} = insertShape(data{1}, 'Rectangle', data{2});
    reset(augmentedTrainingData);
end
figure
montage(augmentedData, 'BorderSize', 10)
```

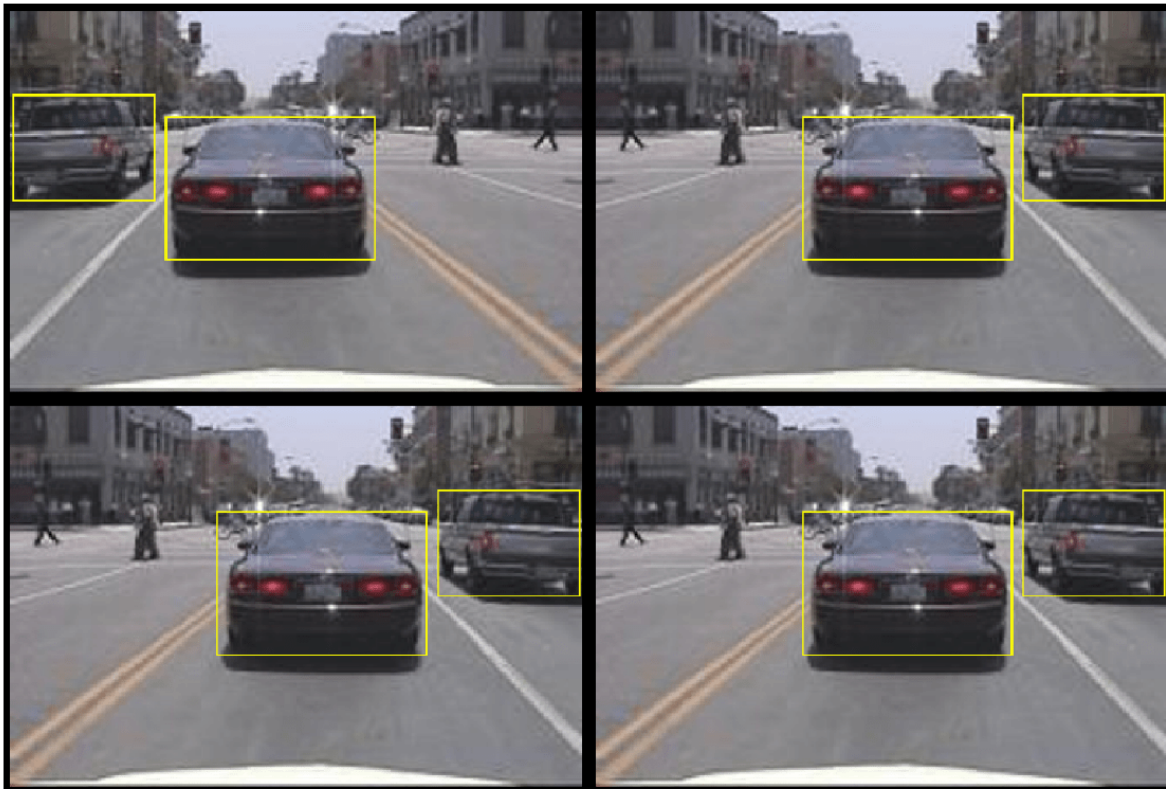

Preprocess Training Data

Preprocess the augmented training data, and the validation data to prepare for training.

```
trainingData = transform(augmentedTrainingData,@(data)preprocessData(data,inputSize));  
validationData = transform(validationData,@(data)preprocessData(data,inputSize));
```

Read the preprocessed data.

```
data = read(trainingData);
```

Display the image and box bounding boxes.

```
I = data{1};  
bbox = data{2};  
annotatedImage = insertShape(I,'Rectangle',bbox);  
annotatedImage = imresize(annotatedImage,2);  
figure  
imshow(annotatedImage)
```



Train Faster R-CNN

Use `trainingOptions` to specify network training options. Set `'ValidationData'` to the preprocessed validation data. Set `'CheckpointPath'` to a temporary location. This enables the saving of partially trained detectors during the training process. If training is interrupted, such as by a power outage or system failure, you can resume training from the saved checkpoint.

```
options = trainingOptions('sgdm',...
    'MaxEpochs',10,...
    'MiniBatchSize',2,...
    'InitialLearnRate',1e-3,...
    'CheckpointPath',tempdir,...
    'ValidationData',validationData);
```

Use `trainFasterRCNNObjectDetector` to train Faster R-CNN object detector if `doTraining` is true. Otherwise, load the pretrained network.

```
if doTraining
    % Train the Faster R-CNN detector.
    % * Adjust NegativeOverlapRange and PositiveOverlapRange to ensure
    %   that training samples tightly overlap with ground truth.
    [detector, info] = trainFasterRCNNObjectDetector(trainingData,lgraph,options, ...
        'NegativeOverlapRange',[0 0.3], ...
        'PositiveOverlapRange',[0.6 1]);
else
    % Load pretrained detector for the example.
    pretrained = load('fasterRCNNResNet50EndToEndVehicleExample.mat');
    detector = pretrained.detector;
end
```

This example was verified on an Nvidia(TM) Titan X GPU with 12 GB of memory. Training the network took approximately 20 minutes. The training time varies depending on the hardware you use.

As a quick check, run the detector on one test image. Make sure you resize the image to the same size as the training images.

```
I = imread(testDataTbl.imageFilename{3});
I = imresize(I,inputSize(1:2));
[bboxes,scores] = detect(detector,I);
```

Display the results.

```
I = insertObjectAnnotation(I,'rectangle',bboxes,scores);
figure
imshow(I)
```

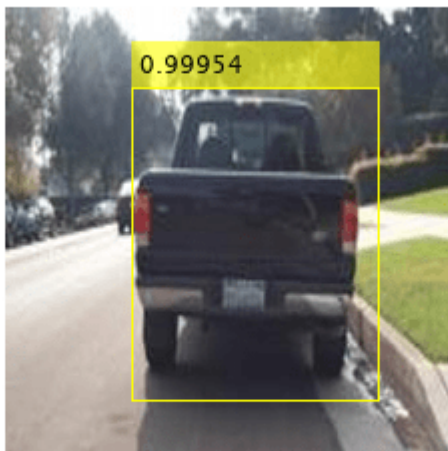

Evaluate Detector Using Test Set

Evaluate the trained object detector on a large set of images to measure the performance. Computer Vision Toolbox™ provides object detector evaluation functions to measure common metrics such as average precision (`evaluateDetectionPrecision`) and log-average miss rates (`evaluateDetectionMissRate`). For this example, use the average precision metric to evaluate performance. The average precision provides a single number that incorporates the ability of the detector to make correct classifications (precision) and the ability of the detector to find all relevant objects (recall).

Apply the same preprocessing transform to the test data as for the training data.

```
testData = transform(testData,@(data)preprocessData(data,inputSize));
```

Run the detector on all the test images.

```
detectionResults = detect(detector,testData,'MinibatchSize',4);
```

Evaluate the object detector using the average precision metric.

```
[ap, recall, precision] = evaluateDetectionPrecision(detectionResults,testData);
```

The precision/recall (PR) curve highlights how precise a detector is at varying levels of recall. The ideal precision is 1 at all recall levels. The use of more data can help improve the average precision but might require more training time. Plot the PR curve.

```
figure  
plot(recall,precision)  
xlabel('Recall')  
ylabel('Precision')  
grid on  
title(sprintf('Average Precision = %.2f', ap))
```

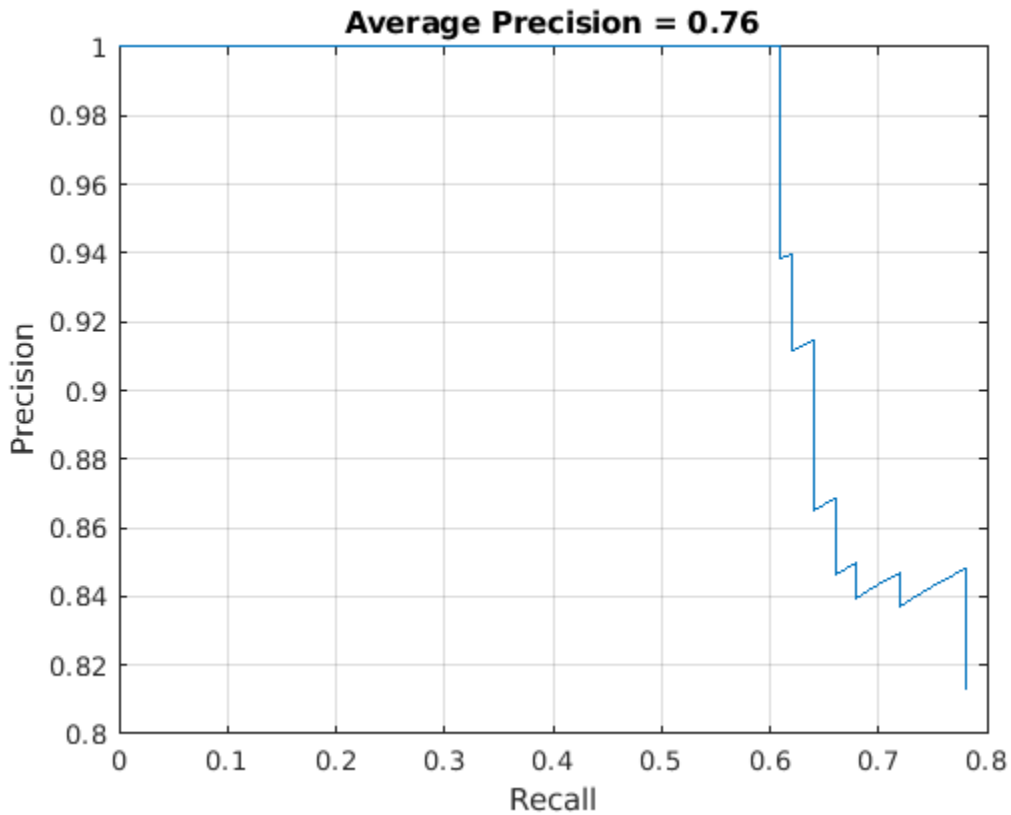
Supporting Functions

```
function data = augmentData(data)
% Randomly flip images and bounding boxes horizontally.
tform = randomAffine2d('XReflection',true);
sz = size(data{1});
rout = affineOutputView(sz,tform);
data{1} = imwarp(data{1},tform,'OutputView',rout);
```

```
% Sanitize box data, if needed.
data{2} = helperSanitizeBoxes(data{2}, sz);
```

```
% Warp boxes.
data{2} = bboxwarp(data{2},tform,rout);
end
```

```
function data = preprocessData(data,targetSize)
% Resize image and bounding boxes to targetSize.
sz = size(data{1},[1 2]);
scale = targetSize(1:2)./sz;
data{1} = imresize(data{1},targetSize(1:2));
```

```
% Sanitize box data, if needed.
data{2} = helperSanitizeBoxes(data{2}, sz);
```

```
% Resize boxes.
```

```
data{2} = bboxresize(data{2},scale);  
end
```

References

- [1] Ren, S., K. He, R. Gershick, and J. Sun. "Faster R-CNN: Towards Real-Time Object Detection with Region Proposal Networks." *IEEE Transactions of Pattern Analysis and Machine Intelligence*. Vol. 39, Issue 6, June 2017, pp. 1137-1149.
- [2] Girshick, R., J. Donahue, T. Darrell, and J. Malik. "Rich Feature Hierarchies for Accurate Object Detection and Semantic Segmentation." *Proceedings of the 2014 IEEE Conference on Computer Vision and Pattern Recognition*. Columbus, OH, June 2014, pp. 580-587.
- [3] Girshick, R. "Fast R-CNN." *Proceedings of the 2015 IEEE International Conference on Computer Vision*. Santiago, Chile, Dec. 2015, pp. 1440-1448.
- [4] Zitnick, C. L., and P. Dollar. "Edge Boxes: Locating Object Proposals from Edges." *European Conference on Computer Vision*. Zurich, Switzerland, Sept. 2014, pp. 391-405.
- [5] Uijlings, J. R. R., K. E. A. van de Sande, T. Gevers, and A. W. M. Smeulders. "Selective Search for Object Recognition." *International Journal of Computer Vision*. Vol. 104, Number 2, Sept. 2013, pp. 154-171.

See Also

Apps

Image Labeler | Video Labeler

Functions

`trainFasterRCNNObjectDetector` | `trainFastRCNNObjectDetector` |
`trainACFObjectDetector` | `trainNetwork` | `selectStrongestBboxMulticlass` |
`SeriesNetwork`

Topics

"Getting Started with R-CNN, Fast R-CNN, and Faster R-CNN"
"Datastores for Deep Learning" (Deep Learning Toolbox)

Introduced in R2017a

maskrcnn

Detect objects using Mask R-CNN instance segmentation

Description

The `maskrcnn` object performs instance segmentation of objects in an image using a Mask R-CNN (regions with convolution neural networks) object detector. To detect objects in an image, pass the trained detector to the `segmentObjects` function.

Note This function requires the Computer Vision Toolbox Model for Mask R-CNN Instance Segmentation. You can install the Computer Vision Toolbox Model for Mask R-CNN Instance Segmentation from Add-On Explorer. For more information about installing add-ons, see [Get and Manage Add-Ons](#). To run this function, you will require the Deep Learning Toolbox.

Creation

Syntax

```
detector = maskrcnn("resnet50-coco")
detector = maskrcnn("resnet50-coco",classNames)
detector = maskrcnn("resnet50-coco",classNames,anchorBoxes)
detector = maskrcnn( ___,Name=Value)
```

Description

`detector = maskrcnn("resnet50-coco")` loads a pretrained Mask R-CNN object detector trained on the COCO data set with a ResNet-50 network as the feature extractor.

`detector = maskrcnn("resnet50-coco",classNames)` creates a pretrained Mask R-CNN object detector and configures it to perform transfer learning using a specified set of object classes. The `classNames` argument sets the `ClassNames` property. For optimal results, train the detector on new training images before performing detection.

`detector = maskrcnn("resnet50-coco",classNames,anchorBoxes)` creates a pretrained Mask R-CNN object detector and configures it to perform transfer learning using a specified set of object classes and anchor boxes. The `classNames` argument sets the `ClassNames` property. The `anchorBoxes` argument sets the `AnchorBoxes` property.

`detector = maskrcnn(___,Name=Value)` uses name-value arguments to specify ROI pooling sizes or to set the `ModelName` or `InputSize` properties. Specify name-value arguments in addition to the input arguments from any of the previous syntaxes.

For example, `maskrcnn("resnet50-coco",classNames,anchorBoxes,PoolSize=[11 11])` specifies the ROI pooling size for the detection head as 11-by-11 pixels.

Input Arguments

Name-Value Pair Arguments

Specify optional pairs of arguments as `Name1=Value1, ..., NameN=ValueN`, where `Name` is the argument name and `Value` is the corresponding value. Name-value arguments must appear after other arguments, but the order of the pairs does not matter.

Example: `maskrcnn("resnet50-coco", classNames, anchorBoxes, PoolSize=[11 11])` specifies the ROI pooling size for the detection head as 11-by-11 pixels.

PoolSize — ROI pooling size for detection head

[14 14] (default) | 1-by-2 vector

ROI pooling size for the detection head, specified as a 1-by-2 vector in the format [*height width*].

MaskPoolSize — ROI pooling size for mask segmentation head

[14 14] (default) | 1-by-2 vector

ROI pooling size for the mask segmentation head, specified as a 1-by-2 vector in the format [*height width*].

Properties

ModelName — Name of trained Mask R-CNN object detection network

'maskrcnn' | string scalar | character vector

Name of the trained Mask R-CNN object detection network, specified as a string scalar or character vector.

AnchorBoxes — Size of anchor boxes

M-by-2 matrix

Size of anchor boxes, specified as an *M*-by-2 matrix, where each row is in the format [*height width*]. The default value consists of 15 anchor boxes defined by the MS-COCO data set. When you specify the anchor boxes, the `maskrcnn` object reinitializes the final convolution layers in the region proposal subnetwork to the correct size based on the number of anchor boxes.

You cannot modify the value of this property after you create the object.

ClassNames — Object class names

cell array

Names of the object classes that the Mask R-CNN detector is trained to detect, specified as a cell array. The default value consists of the 80 object class names in the MS-COCO data set, such as "person", "bicycle", and "car". When you specify the class names, the `maskrcnn` object reinitializes the final convolution layers in the detection head and mask segmentation head to the correct size based on the number of classes.

You cannot modify the value of this property after you create the object.

InputSize — Image size

[800 1200 3] | 1-by-3 vector

Image size to use for detection, specified as a 1-by-3 vector of positive integers in the format [*height width* 3]. The detector resizes input images to this size while maintaining the aspect ratio. The default value is the network input size.

You cannot modify the value of this property after you create the object.

Object Functions

`forward` Run forward pass on Mask R-CNN network
`segmentObjects` Segment objects using Mask R-CNN instance segmentation

Examples

Segment Instances of Objects

Load a pretrained Mask R-CNN object detector.

```
detector = maskrcnn("resnet50-coco")
```

```
detector =  
    maskrcnn with properties:  
  
    ModelName: 'maskrcnn'  
    ClassNames: {1×80 cell}  
    InputSize: [800 1200 3]  
    AnchorBoxes: [15×2 double]
```

Read a test image that includes objects that the network can detect, such as people.

```
I = imread("visionteam.jpg");
```

Segment instances of objects using the Mask R-CNN object detector.

```
[masks,labels,scores,boxes] = segmentObjects(detector,I,Threshold=0.95);
```

Overlay the detected object masks in blue on the test image. Display the bounding boxes in red and the object labels.

```
overlaidImage = insertObjectMask(I,masks);  
imshow(overlaidImage)  
showShape("rectangle",boxes,Label=labels,LineColor=[1 0 0])
```

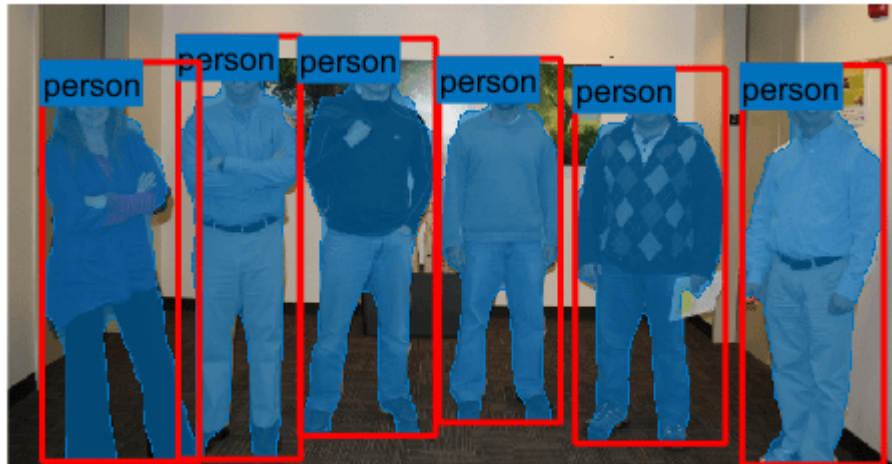

See Also

Apps

[Image Labeler](#) | [Video Labeler](#)

Functions

[SeriesNetwork](#) | [trainNetwork](#) | [fastRCNNObjectDetector](#) | [fasterRCNNObjectDetector](#)

Topics

[“Getting Started with Mask R-CNN for Instance Segmentation”](#)
[“Perform Instance Segmentation Using Mask R-CNN”](#)

Introduced in R2021b

forward

Run forward pass on Mask R-CNN network

Syntax

```
outputFeatures = forward(detector,dlX)
[outputFeatures,state] = forward(detector,dlX)
```

Description

`outputFeatures = forward(detector,dlX)` calculates features of the image `dlX` from the output layers of the Mask R-CNN object detector.

`[outputFeatures,state] = forward(detector,dlX)` also returns the state information of the network. Use the state to update the network parameters.

Note This function requires the Computer Vision Toolbox Model for Mask R-CNN Instance Segmentation. You can install the Computer Vision Toolbox Model for Mask R-CNN Instance Segmentation from Add-On Explorer. For more information about installing add-ons, see [Get and Manage Add-Ons](#). To run this function, you will require the Deep Learning Toolbox.

Examples

Calculate Features of Color Image

Load a pretrained Mask R-CNN object detector.

```
detector = maskrcnn("resnet50-coco");
```

Read an image to use for training, and convert the image to a formatted `dlarray` object.

```
I = imread("visionteam.jpg");
dlX = dlarray(single(I),"SSCB");
```

Calculate features of the training image.

```
outputFeatures = forward(detector,dlX);
```

Input Arguments

detector — Mask R-CNN object detector

`maskrcnn` object

Mask R-CNN object detector, specified as a `maskrcnn` object.

dlX — Training data

formatted `dlarray` object

Training data, specified as a formatted `dLarray` object containing real, nonsparse data. The dimension labels of the data must be "SSCB".

Output Arguments

outputFeatures — Output features

1-by-6 cell array

Output features, returned as a 1-by-6 cell array. Each element contains activations from an output layer of the network, as described in the table. In the table, *numClasses* is the number of classes and *numAnchors* is the number of anchor boxes. *B* is the number of images in the batch. *numProposals* is the number of proposals from the region proposal layer.

Network Output	Format
Region proposal network classification output after the softmax operation	h -by- w -by- $numAnchors$ -by- B array. The feature map has spatial size h -by- w .
Region proposal network regression output	h -by- w -by- $(4 \times numAnchors)$ -by- B array. The feature map has spatial size h -by- w .
Region proposals	5-by- $numProposals$ matrix. Each column of the proposals contains box proposals in the format $[xStart, yStart, xEnd, yEnd, batchIdx]$.
Detection network classification output after the softmax operation	1-by-1-by- $(numClasses+1)$ -by- $numProposals$ array.
Detection network regression output	1-by-1-by- $(4 \times numClasses)$ -by- $numProposals$ array.
Mask segmentation output	h_{mask} -by- w_{mask} -by- $numClasses$ -by- $numProposals$ array. The mask segmentation output has spatial size h_{mask} -by- w_{mask} .

state — Updated network state

table

Updated network state, returned as a table. The network state is a table with three columns:

- **Layer** - Layer name, returned as a string scalar.
- **Parameter** - Parameter name, returned as a string scalar.
- **Value** - Value of parameter, returned as a numeric array object.

The network state contains information remembered by the network between iterations.

See Also

maskrcnn | segmentObjects

Introduced in R2021b

segmentObjects

Segment objects using Mask R-CNN instance segmentation

Syntax

```
masks = segmentObjects(detector,I)
masks = segmentObjects(detector,I,Name=Value)

[masks,labels] = segmentObjects(____)
[masks,labels,scores] = segmentObjects(____)
[masks,labels,scores,bboxes] = segmentObjects(____)
```

Description

`masks = segmentObjects(detector,I)` detects object masks within a single image or an array of images, `I`, using a Mask R-CNN object detector.

`masks = segmentObjects(detector,I,Name=Value)` configures the segmentation using additional name-value arguments. For example, `segmentObjects(detector,I,Threshold=0.9)` specifies the detection threshold as `0.9`.

`[masks,labels] = segmentObjects(____)` also returns the labels assigned to the detected objects.

`[masks,labels,scores] = segmentObjects(____)` also returns the detection score for each of the detected objects.

`[masks,labels,scores,bboxes] = segmentObjects(____)` also returns the location of segmented object as bounding boxes, `bboxes`.

Note This function requires the Computer Vision Toolbox Model for Mask R-CNN Instance Segmentation. You can install the Computer Vision Toolbox Model for Mask R-CNN Instance Segmentation from Add-On Explorer. For more information about installing add-ons, see [Get and Manage Add-Ons](#). To run this function, you will require the Deep Learning Toolbox.

Examples

Segment Instances of Objects

Load a pretrained Mask R-CNN object detector.

```
detector = maskrcnn("resnet50-coco")

detector =
    maskrcnn with properties:
        ModelName: 'maskrcnn'
        ClassNames: {1x80 cell}
```

```
InputSize: [800 1200 3]
AnchorBoxes: [15x2 double]
```

Read a test image that includes objects that the network can detect, such as people.

```
I = imread("visionteam.jpg");
```

Segment instances of objects using the Mask R-CNN object detector.

```
[masks,labels,scores,boxes] = segmentObjects(detector,I,Threshold=0.95);
```

Overlay the detected object masks in blue on the test image. Display the bounding boxes in red and the object labels.

```
overlaidImage = insertObjectMask(I,masks);
imshow(overlaidImage)
showShape("rectangle",boxes,Label=labels,LineColor=[1 0 0])
```

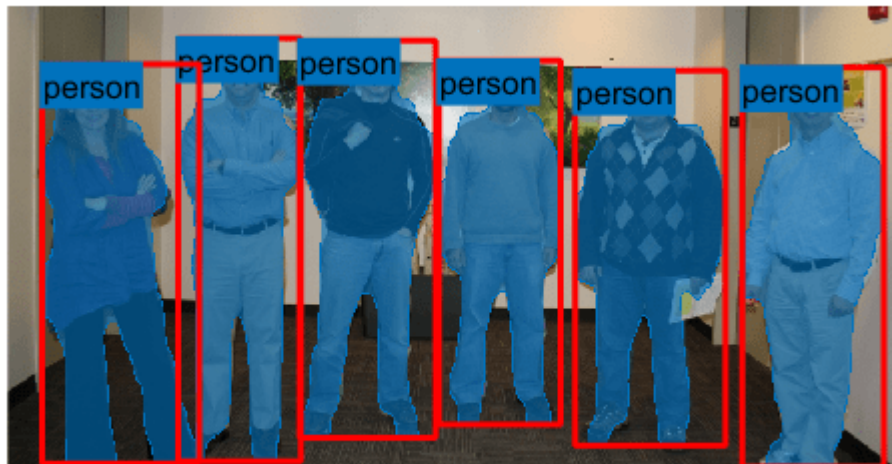

Input Arguments

detector — Mask R-CNN object detector

maskrcnn object

Mask R-CNN object detector, specified as a maskrcnn object.

I — Image or batch of images

numeric matrix | numeric array

Image or batch of images to segment, specified as one of these values.

Image Type	Data Format
Single grayscale image	2-D matrix of size H -by- W

Image Type	Data Format
Single color image	3-D array of size H -by- W -by-3.
Batch of B grayscale or color images	4-D array of size H -by- W -by- C -by- B . The number of color channels C is 1 for grayscale images and 3 for color images.

The height H and width W of each image must be greater than or equal to the input height h and width w of the network.

Name-Value Pair Arguments

Specify optional pairs of arguments as `Name1=Value1, ..., NameN=ValueN`, where `Name` is the argument name and `Value` is the corresponding value. Name-value arguments must appear after other arguments, but the order of the pairs does not matter.

Example: `segmentObjects(detector,I,Threshold=0.9)` specifies the detection threshold as 0.9.

Threshold — Detection threshold

0.7 (default) | numeric scalar

Detection threshold, specified as a numeric scalar in the range [0, 1]. The Mask R-CNN object detector does not return detections with scores less than the threshold value. Increase this value to reduce false positives.

NumStrongestRegions — Maximum number of strongest region proposals

1000 (default) | positive integer | Inf

Maximum number of strongest region proposals, specified as a positive integer. Reduce this value to speed up processing time at the cost of detection accuracy. To use all region proposals, specify this value as Inf.

SelectStrongest — Select strongest bounding box

true or 1 (default) | false or 0

Select the strongest bounding box for each detected object, specified as a numeric or logical 1 (true) or 0 (false).

- `true` — Return the strongest bounding box per object. To select these boxes, the `segmentObjects` function calls the `selectStrongestBboxMulticlass` function, which uses nonmaximal suppression to eliminate overlapping bounding boxes based on their confidence scores.
- `false` — Return all detected bounding boxes. You can then create your own custom operation to eliminate overlapping bounding boxes.

MinSize — Minimum size of region

[1 1] (default) | two-element numeric vector

Minimum size of a region containing an object, in pixels, specified as a two-element numeric vector of the form `[height width]`. By default, `MinSize` is the smallest object that the trained detector can detect. Specify this argument to reduce the computation time.

MaxSize — Maximum size of region

two-element numeric vector

Maximum size of a region containing an object, in pixels, specified as a two-element numeric vector of the form [*height width*].

To reduce computation time, set this value to the known maximum region size for the objects being detected in the image. By default, `MaxSize` is set to the height and width of the input image, `I`.

ExecutionEnvironment — Hardware resource

"auto" (default) | "gpu" | "cpu"

Hardware resource for processing images with a network, specified as "auto", "gpu", or "cpu".

ExecutionEnvironment	Description
"auto"	Use a GPU if available. Otherwise, use the CPU. The use of GPU requires Parallel Computing Toolbox and a CUDA enabled NVIDIA GPU. For information about the supported compute capabilities, see "GPU Support by Release" (Parallel Computing Toolbox).
"gpu"	Use the GPU. If a suitable GPU is not available, the function returns an error message.
"cpu"	Use the CPU.

Output Arguments

masks — Object masks

H-by-*W*-by-*M* logical array | *B*-by-1 cell array

Objects masks, returned as a logical array of size *H*-by-*W*-by-*M*. *H* and *W* are the height and width of the input image `I`. *M* is the number of objects detected in the image. Each of the *M* channels contains the mask for a single detected object.

When `I` represents a batch of *B* images, `masks` is returned as a *B*-by-1 cell array. Each element in the cell array indicates the masks for the corresponding input image in the batch.

labels — Object labels

M-by-1 categorical vector | *B*-by-1 cell array

Objects labels, returned as an *M*-by-1 categorical vector where *M* is the number of detected objects in image `I`.

When `I` represents a batch of *B* images, then `labels` is a *B*-by-1 cell array. Each element is an *M*-by-1 categorical vector with the labels of the objects in the corresponding image.

scores — Detection scores

M-by-1 vector | *B*-by-1 cell array

Detection confidence scores, returned as an *M*-by-1 numeric vector, where *M* is the number of detected objects in image `I`. A higher score indicates higher confidence in the detection.

When `I` represents a batch of *B* images, then `scores` is a *B*-by-1 cell array. Each element is an *M*-by-1 numeric vector with the labels of the objects in the corresponding image.

bboxes — Location of detected objects

M-by-4 matrix | *B*-by-1 cell array

Location of detected objects within the input image, returned as an M -by-4 matrix, where M is the number of detected objects in image I . Each row of `bboxes` contains a four-element vector of the form `[x y width height]`. This vector specifies the upper left corner and size of that corresponding bounding box in pixels.

When I represents a batch of B images, then `bboxes` is a B -by-1 cell array. Each element is an M -by-4 numeric matrix with the bounding boxes of the objects in the corresponding image.

See Also

`forward`

Introduced in R2021b

yolov2ObjectDetector

Detect objects using YOLO v2 object detector

Description

The `yolov2ObjectDetector` object defines the trained YOLO v2 object detector. To detect objects in an image, pass the trained YOLO v2 object detector to the `detect` object function. The YOLO v2 object detector recognizes specific objects in images, based on the training images and ground truth data used with the `trainYOLOv2ObjectDetector` function. You can also use the `yolov2ObjectDetector` function to create the `yolov2ObjectDetector` object from a pretrained YOLO v2 network.

Creation

Create a `yolov2ObjectDetector` object by calling the `trainYOLOv2ObjectDetector` function with training data (requires Deep Learning Toolbox).

```
detector = trainYOLOv2ObjectDetector(trainingData,___)
```

Syntax

```
detector = yolov2ObjectDetector(network)
detector = yolov2ObjectDetector( ____, 'TrainingImageSize', trainingSizes)
```

Description

`detector = yolov2ObjectDetector(network)` creates a YOLO v2 object detector by using the pretrained YOLO v2 network specified at the input.

The input network can also be an imported network from ONNX™ (Open Neural Network Exchange). For more information on how to create YOLO v2 object detector from an imported ONNX YOLO v2 network, see “Import Pretrained ONNX YOLO v2 Object Detector”.

`detector = yolov2ObjectDetector(____, 'TrainingImageSize', trainingSizes)` specify image sizes used during training by using a name-value pair in addition to the input argument in the previous syntax.

Input Arguments

network — Pretrained YOLO v2 network

DAGNetwork object

Pretrained YOLO v2 network, specified as a DAGNetwork object. The DAGNetwork must have an image input layer, YOLO v2 transform layer that is connected to a YOLO v2 output layer.

trainingSizes — Set of image sizes used for training

M-by-2 matrix

Set of image sizes used for training, specified as a comma-separated pair consisting of 'TrainingImageSize' and a M -by-2 matrix. Each row is of the form [height width]. The default value is the size of the image input layer of the network.

Data Types: single | double | int8 | int16 | int32 | int64 | uint8 | uint16 | uint32 | uint64

Properties

ModelName — Name of the classification model

character vector | string scalar

Name of the classification model, specified as a character vector or string scalar. By default, the name is set to the heading of the second column of the `trainingData` table specified in the `trainYOLOv2ObjectDetector` function. You can modify this name after creating the `yolov2ObjectDetector` object.

Network — Trained YOLO v2 object detection network

DAGNetwork object

This property is read-only.

Trained YOLO v2 object detection network, specified as a DAGNetwork object. This object stores the layers that define the YOLO v2 object detection network.

ClassNames — Names of object classes

cell array of character vectors

This property is read-only.

Names of object classes that the YOLO v2 object detector was trained to find, specified as a cell array of character vectors. This property is set by the `trainingData` input argument in the `trainYOLOv2ObjectDetector` function. Specify the class names as part of the `trainingData` table.

AnchorBoxes — Set of anchor boxes

N -by-2 matrix

This property is read-only.

Set of anchor boxes, specified as an N -by-2 matrix defining the width and the height of N anchor boxes. This property is set by the `AnchorBoxes` property of the output layer in the YOLO v2 network.

The anchor boxes are defined when creating the YOLO v2 network by using the `yolov2Layers` function. Alternatively, if you create the YOLO v2 network layer-by-layer, the anchor boxes are defined by using the `yolov2OutputLayer` function.

TrainingImageSize — Set of image sizes used for training

M -by-2 matrix

This property is read-only.

Set of image sizes used for training, specified as an M -by-2 matrix, where each row is of the form [height width]. This property is set by the `trainingSizes` input argument.

If `trainingSizes` is not specified at the input, then this property is set by the `trainingSizes` argument in the `trainYOLOv2objectDetector` function. In this case, the `yoloV2objectDetector` object is created by calling the `trainYOLOv2objectDetector` function.

Object Functions

`detect` Detect objects using YOLO v2 object detector

Extended Capabilities

C/C++ Code Generation

Generate C and C++ code using MATLAB® Coder™.

Usage notes and limitations:

- Only the `detect` method of the `yoloV2objectDetector` is supported for code generation.
- The `roi` argument to the `detect` method must be a code generation constant (`coder.const()`) and a 1x4 vector.
- Only the `Threshold`, `SelectStrongest`, `MinSize`, and `MaxSize` name-value pairs for `detect` are supported.

GPU Code Generation

Generate CUDA® code for NVIDIA® GPUs using GPU Coder™.

Usage notes and limitations:

For code generation,

- Only the `detect` method of the `yoloV2objectDetector` is supported for code generation.
- The `roi` argument to the `detect` method must be a codegen constant (`coder.const()`) and a 1x4 vector.
- Only the `Threshold`, `SelectStrongest`, `MinSize`, `MaxSize`, and `MiniBatchSize` Name-Value pairs are supported.
- The height, width, channel, and batch size of the input image must be fixed size.
- The minimum batch size value passed to `detect` method must be fixed size.

See Also

Apps

[Image Labeler](#) | [Video Labeler](#)

Functions

[yoloV2Layers](#)

Objects

[fasterRCNNObjectDetector](#) | [trainYOLOv2objectDetector](#) | [boxLabelDatastore](#)

Topics

[“Create YOLO v2 Object Detection Network”](#)

[“Object Detection Using YOLO v2 Deep Learning”](#)

[“Estimate Anchor Boxes From Training Data”](#)

“Code Generation for Object Detection by Using YOLO v2”
“Getting Started with YOLO v2”
“Anchor Boxes for Object Detection”
“Datastores for Deep Learning” (Deep Learning Toolbox)

Introduced in R2019a

yolov3ObjectDetector

Create YOLO v3 object detector

Description

The `yolov3ObjectDetector` object creates a you only look once version 3 (YOLO v3) object detector for detecting objects in an image. Using this object, you can:

- Create a pretrained YOLO v3 object detector by using YOLO v3 deep learning networks trained on COCO dataset.
- Create a custom YOLO v3 object detector by using any pretrained or untrained YOLO v3 deep learning network.

Creation

Syntax

```
detector = yolov3ObjectDetector(name)
```

```
detector = yolov3ObjectDetector(name, classes, aboxes)  
detector = yolov3ObjectDetector(net, classes, aboxes)  
detector = yolov3ObjectDetector(baseNet, classes,  
aboxes, 'DetectionNetworkSource', layer)
```

Description

Pretrained YOLO v3 Object Detector

`detector = yolov3ObjectDetector(name)` creates a pretrained YOLO v3 object detector by using YOLO v3 deep learning networks trained on a COCO dataset.

Custom YOLO v3 Object Detector

`detector = yolov3ObjectDetector(name, classes, aboxes)` creates a pretrained YOLO v3 object detector and configures it to perform transfer learning using a specified set of object classes and anchor boxes. For optimal results, you must train the detector on new training images before performing detection.

`detector = yolov3ObjectDetector(net, classes, aboxes)` creates an object detector by using the deep learning network `net`.

If `net` is a pretrained YOLO v3 deep learning network, the function creates a pretrained YOLO v3 object detector. The `classes` and `aboxes` are values used for training the network.

If `net` is an untrained YOLO v3 deep learning network, the function creates a YOLO v3 object detector to use for training and inference. `classes` and `aboxes` specify the object classes and the anchor boxes, respectively, for training the YOLO v3 network.

You must train the detector on a training dataset before performing object detection. For information about how to train a YOLO v3 object detector, see **Preprocess Training Data** and **Train Model** sections in the “Object Detection Using YOLO v3 Deep Learning” example.

`detector = yolov3ObjectDetector(baseNet, classes, aboxes, 'DetectionNetworkSource', layer)` creates a YOLO v3 object detector by adding detection heads to a base network, `baseNet`.

The function adds detection heads to the specified feature extraction layers `layer` in the base network. To specify the names of the feature extraction layers, use the name-value argument `'DetectionNetworkSource', layer`.

If `baseNet` is a pretrained deep learning network, the function creates a YOLO v3 object detector and configures it to perform transfer learning with the specified object classes and anchor boxes.

If `baseNet` is an untrained deep learning network, the function creates a YOLO v3 object detector and configures it for object detection. `classes` and `aboxes` specify the object classes and the anchor boxes, respectively, for training the YOLO v3 network.

You must train the detector on a training dataset before performing object detection.

`detector = yolov3ObjectDetector(____, Name, Value)` sets the `InputSize` on page 2-0 and `ModelName` on page 2-0 properties of the object detector by using name-value pair arguments. `Name` is the property name and `Value` is the corresponding value. You must enclose each property name in quotes.

Note This function requires the Computer Vision Toolbox Model for YOLO v3 Object Detection. You can install the Computer Vision Toolbox Model for YOLO v3 Object Detection from Add-On Explorer. For more information about installing add-ons, see Get and Manage Add-Ons. To run this function, you will require the Deep Learning Toolbox.

Input Arguments

name — Name of pretrained YOLO v3 deep learning network

'darknet53-coco' | 'tiny-yolov3-coco'

Name of the pretrained YOLO v3 deep learning network, specified as one of these:

- 'darknet53-coco' — A pretrained YOLO v3 deep learning network created using DarkNet-53 as the base network and trained on COCO dataset.
- 'tiny-yolov3-coco' — A pretrained YOLO v3 deep learning network created using a small base network and trained on COCO dataset.

Data Types: `string`

classes — Names of object classes

`string vector` | `cell array of character vectors` | `categorical vector`

Names of object classes for training the detector, specified as a string vector, cell array of character vectors, or categorical vector. This argument sets the `ClassNames` property of the `yolov3ObjectDetector` object.

Data Types: `char` | `string` | `categorical`

aboxes — Anchor boxes*N*-by-1 cell array

Anchor boxes for training the detector, specified as an *N*-by-1 cell array. *N* is the number of output layers in the YOLO v3 deep learning network. Each cell contains an *M*-by-2 matrix, where *M* is the number of anchor boxes in that layer. Each row in the *M*-by-2 matrix denotes the size of an anchor box in the form [*height width*].

The first element in the cell array specifies the anchor boxes to associate with the first output layer, the second element in the cell array specifies the anchor boxes to associate with the second output layer, and so on. For accurate detection results, specify large anchor boxes for the first output layer and small anchor boxes for the last output layer. That is, the anchor box sizes must decrease for each output layer in the order in which the layers appear in the YOLO v3 deep learning network.

This argument sets the `AnchorBoxes` property of the `yoLov3ObjectDetector` object.

Data Types: `cell`

net — YOLO v3 deep learning network*dlnetwork* object

YOLO v3 deep learning network, specified as a *dlnetwork* object. The input network can be either an untrained or a pretrained deep learning network.

baseNet — Base network*dlnetwork* object | *DAGNetwork* object

Base network for creating the YOLO v3 deep learning network, specified as a *dlnetwork* object, or *DAGNetwork* object. The network can be either an untrained or a pretrained deep learning network.

layer — Names of feature extraction layers

cell array of character vectors | string array

Names of the feature extraction layers in the base network, specified as a cell array of character vectors, or a string array.

The function creates a YOLO v3 network by adding detection head layers to the output of the feature extraction layers in the base network. The feature extraction layers must be specified in the reverse of the order in which they appear in the network architecture. For example, given a base network with four feature extraction layers, you must add the first detection head to the fourth feature extraction layer, the second detection head to the third feature extraction layer, and so on.

Example: `layer = {'conv10', 'fire9-concat', 'fire8-concat'}`

Example: `layer = ["conv10", "fire9-concat", "fire8-concat"]`

Data Types: `char` | `string` | `cell`

Properties**Network — YOLO v3 deep learning network***dlnetwork* object

This property is read-only.

YOLO v3 deep learning network to use for object detection, stored as a *dlnetwork* object.

ClassNames — Names of object classes

categorical vector

This property is read-only.

Names of object classes to detect, stored as a categorical vector. You can set this property by using the input argument `classes`.

AnchorBoxes — Set of anchor boxes N -by-1 cell array

This property is read-only.

Set of anchor boxes, stored as a N -by-1 cell array. Each element in the cell is a M -by-2 matrix. Each row in the M -by-2 matrix denotes the size of the anchor box in the form of [*height width*]. M denotes the number of anchor boxes. N is the number of output layers in the YOLO v3 deep learning network for which the anchor boxes are defined. The first element in the cell array specifies the anchor boxes for the first output layer, the second element in the cell array specifies the anchor boxes for the second output layer, and so on.

You can set this property by using the input argument `aboxes`.

InputSize — Set of image sizes used for training M -by-2 matrix

This property is read-only.

Set of image sizes used for training, stored as an M -by-2 matrix of type `double`. Each row is of the form [*height width*]. To set this property, specify it at object creation.

For example, `detector = yolov3ObjectDetector(net, classes, aboxes, 'InputSize', [220 220; 440 440])`.

ModelName — Name for object detector

' ' (default) | character vector | string scalar

Name for the object detector, stored as a character vector or string scalar. To set this property, specify it at object creation.

For example, `yolov3ObjectDetector(net, classes, aboxes, 'ModelName', 'customDetector')` sets the name for the object detector to `'customDetector'`.

Object Functions

<code>detect</code>	Detect objects using YOLO v3 object detector
<code>preprocess</code>	Preprocess training and test images
<code>forward</code>	Compute YOLO v3 deep learning network output for training
<code>predict</code>	Compute YOLO v3 deep learning network outputs for inference

Examples

Create Pretrained YOLO v3 Object Detector

Specify the name of a pretrained YOLO v3 deep learning network.

```
name = 'tiny-yolov3-coco';
```

Create YOLO v3 object detector by using the pretrained YOLO v3 network.

```
detector = yolov3objectDetector(name);
```

Display and inspect the properties of the YOLO v3 object detector.

```
disp(detector)
```

```
yolov3objectDetector with properties:
```

```

    Network: [1x1 dlnetwork]
AnchorBoxes: {2x1 cell}
ClassNames: [1x80 categorical]
InputSize: [416 416]
Learnables: [48x3 table]
    State: [22x3 table]
    ModelName: 'tiny-yolov3-coco'
```

Use `analyzeNetwork` to display the YOLO v3 network architecture and get information about the network layers. The network has two detection heads attached to the feature extraction network.

```
analyzeNetwork(detector.Network)
```

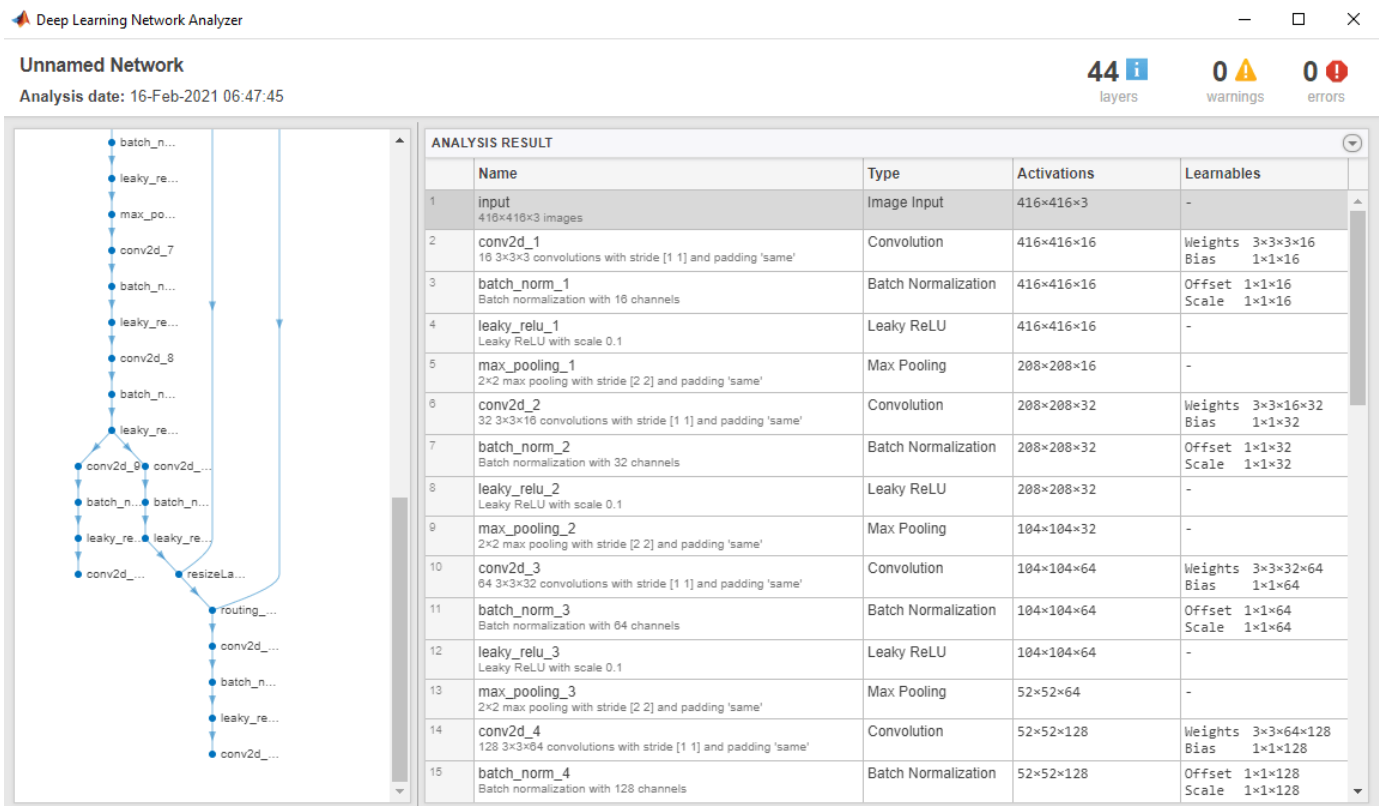

Detect objects in an unknown image by using the pretrained YOLO v3 object detector.

```
img = imread('sherlock.jpg');  
img = preprocess(detector,img);  
[bboxes,scores,labels] = detect(detector,img,'DetectionPreprocessing','none');
```

Display the detection results.

```
detectedImg = insertObjectAnnotation(img,'Rectangle',bboxes,labels);  
figure  
imshow(detectedImg)
```

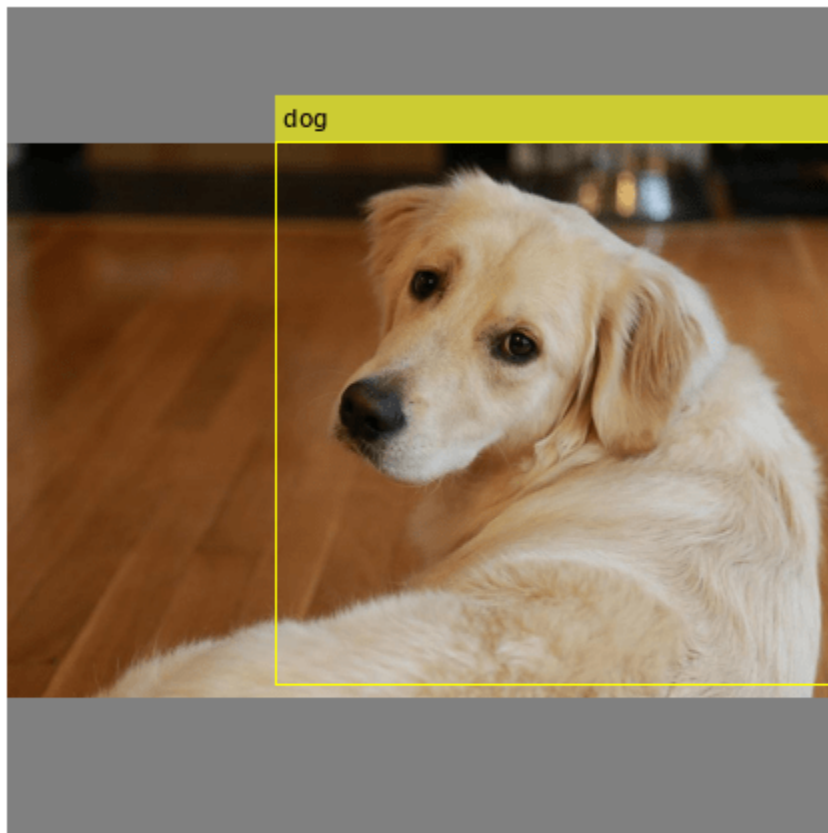

Create Custom YOLO v3 Object Detector

This example shows how to create a custom YOLO v3 object detector by using a pretrained SqueezeNet as the base network.

Load a pretrained SqueezeNet network. The SqueezeNet network is a convolutional neural network that you can use as the base network for creating a YOLO v3 object detector.

```
net = squeezenet
```

```
net =
```

```
DAGNetwork with properties:
```

```
Layers: [68x1 nnet.cnn.layer.Layer]
```

```
Connections: [75x2 table]
```

```
InputNames: {'data'}
```

```
OutputNames: {'ClassificationLayer_predictions'}
```

Inspect the architecture of the base network by using `analyzeNetwork` (Deep Learning Toolbox) function.

```
analyzeNetwork(net)
```

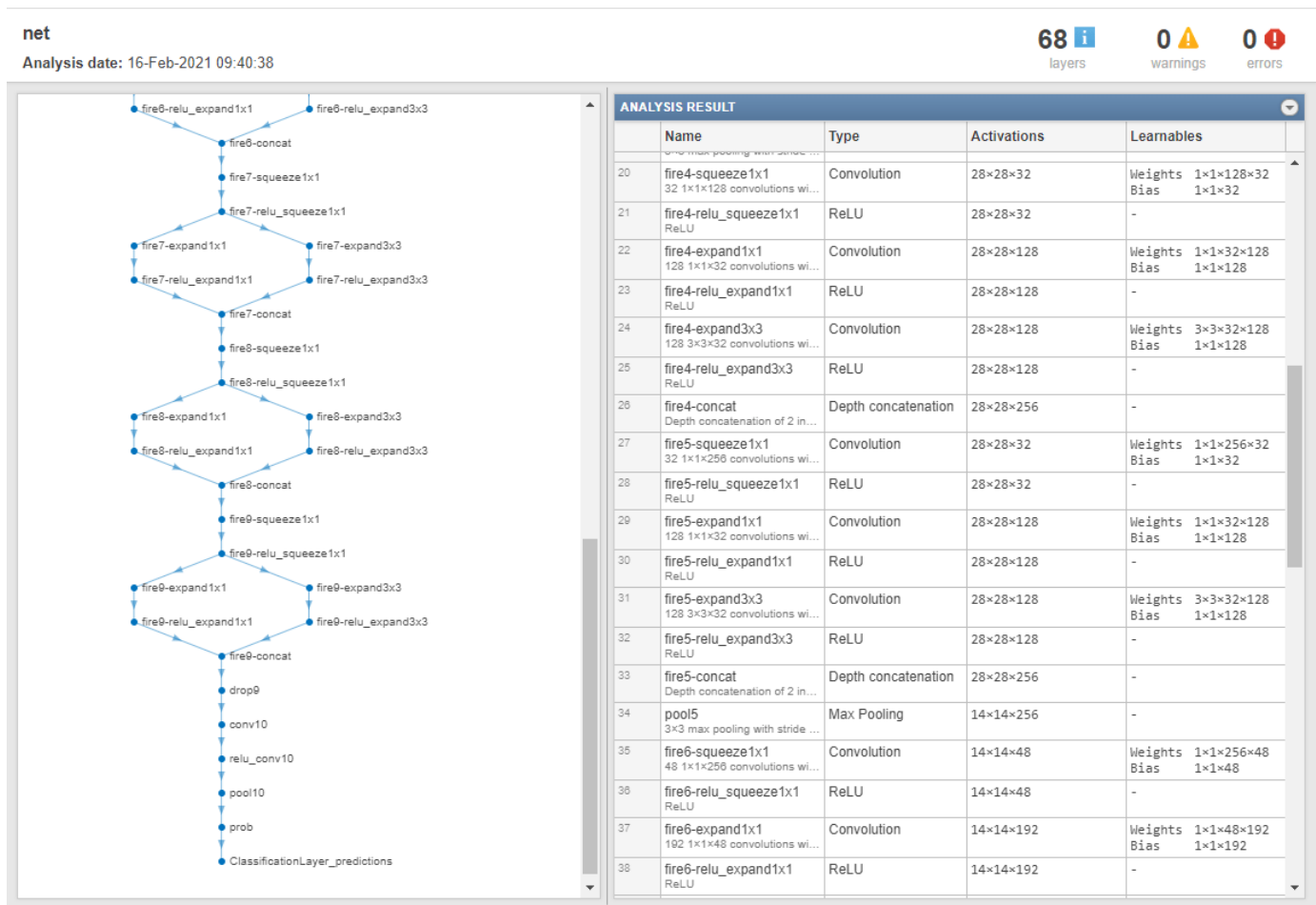

Specify the anchor boxes and the classes to use to train the YOLO v3 network.

```
aboxes = {[150, 127; 97, 90; 68, 67]; [38, 42; 41, 29; 31, 23]};  
classes = {'Car', 'Truck'};
```

Select two feature extraction layers in the base network to serve as the source for detection subnetwork.

```
layer = {'fire9-concat', 'fire8-concat'};
```

Create a custom YOLO v3 object detector by adding detection heads to the feature extraction layers of the base network. Specify the model name, classes, and the anchor boxes.

```
detector = yolov3objectDetector(net, classes, aboxes, 'ModelName', 'Custom YOLO v3', 'DetectionNetwork')
```

Inspect the architecture of the YOLO v3 deep learning network by using `analyzeNetwork` (Deep Learning Toolbox) function.

```
analyzeNetwork(detector.Network)
```

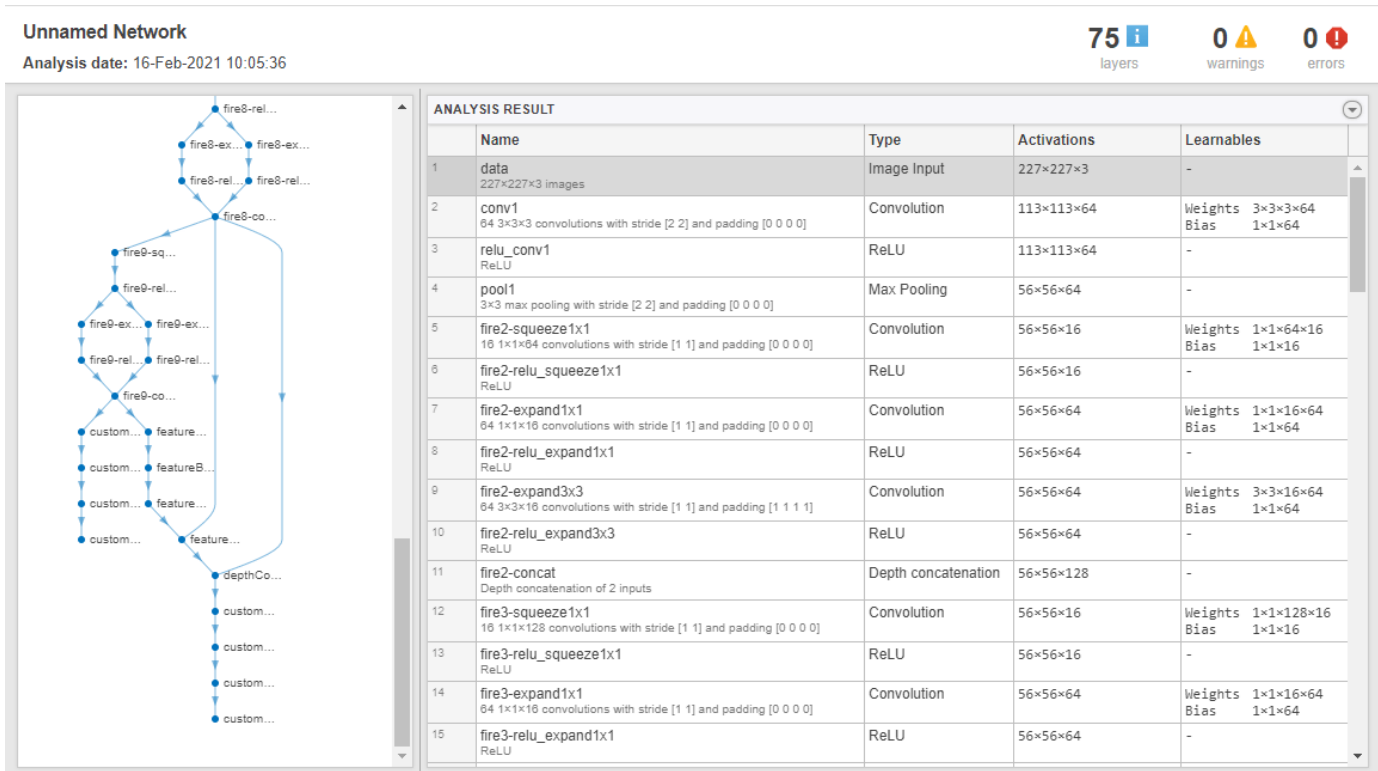

Inspect the properties of the YOLO v3 object detector. You can now train the YOLO v3 object detector on a custom training dataset and perform object detection.

```
disp(detector)
```

yolov3objectDetector with properties:

```
Network: [1×1 dlnetwork]
AnchorBoxes: {2×1 cell}
ClassNames: [Car Truck]
InputSize: [227 227]
Learnables: [66×3 table]
State: [6×3 table]
ModelName: 'Custom YOLO v3'
```

For information about how to train a YOLO v3 object detector, see the “Object Detection Using YOLO v3 Deep Learning” example.

See Also

[yoloV2ObjectDetector](#) | [trainYOLOv2ObjectDetector](#) | [fasterRCNNObjectDetector](#)

Topics

[“Object Detection Using YOLO v3 Deep Learning”](#)

[“Getting Started with YOLO v3”](#)

Introduced in R2021a

detect

Detect objects using YOLO v3 object detector

Syntax

```
bboxes = detect(detector,I)
[bboxes,scores] = detect(detector,I)
[bboxes,scores,labels] = detect(detector,I)
```

```
detectionResults = detect(detector,ds)
```

```
[ ___ ] = detect( ___ , roi)
[ ___ ] = detect( ___ ,Name,Value)
```

Description

`bboxes = detect(detector,I)` detects objects within a single image or an array of images, `I`, using a you look only once version 3 (YOLO v3) object detector, `detector`. The input size of the image must be greater than or equal to the network input size of the pretrained detector. The locations of objects detected are returned as a set of bounding boxes.

`[bboxes,scores] = detect(detector,I)` also returns the class-specific confidence scores for each bounding box.

`[bboxes,scores,labels] = detect(detector,I)` returns a categorical array of labels assigned to the bounding boxes. The labels for object classes are defined during training.

`detectionResults = detect(detector,ds)` detects objects within all the images returned by the `read` function of the input datastore `ds`.

`[___] = detect(___ , roi)` detects objects within the rectangular search region `roi`, in addition to any combination of arguments from previous syntaxes.

`[___] = detect(___ ,Name,Value)` specifies options using one or more name-value arguments.

Note This function requires the Computer Vision Toolbox Model for YOLO v3 Object Detection. You can install the Computer Vision Toolbox Model for YOLO v3 Object Detection from Add-On Explorer. For more information about installing add-ons, see [Get and Manage Add-Ons](#). To run this function, you will require the Deep Learning Toolbox.

Examples

Detect Objects Using YOLO v3 Object Detector

Load a pretrained YOLO v3 object detector.

```
detector = yolov3objectDetector('tiny-yolov3-coco');
```

Read a test image and preprocess the test image by using the `preprocess` function.

```
img = imread('sherlock.jpg');  
img = preprocess(detector,img);
```

Detect objects in the test image.

```
[bboxes,scores,labels] = detect(detector,img);
```

Display the detection results.

```
results = table(bboxes,labels,scores)
```

```
results=1x3 table  
      bboxes      labels      scores  
-----  
    134     69    280    272     dog     0.56819
```

```
detectedImg = insertObjectAnnotation(img,'Rectangle',bboxes,labels);  
figure  
imshow(detectedImg)
```

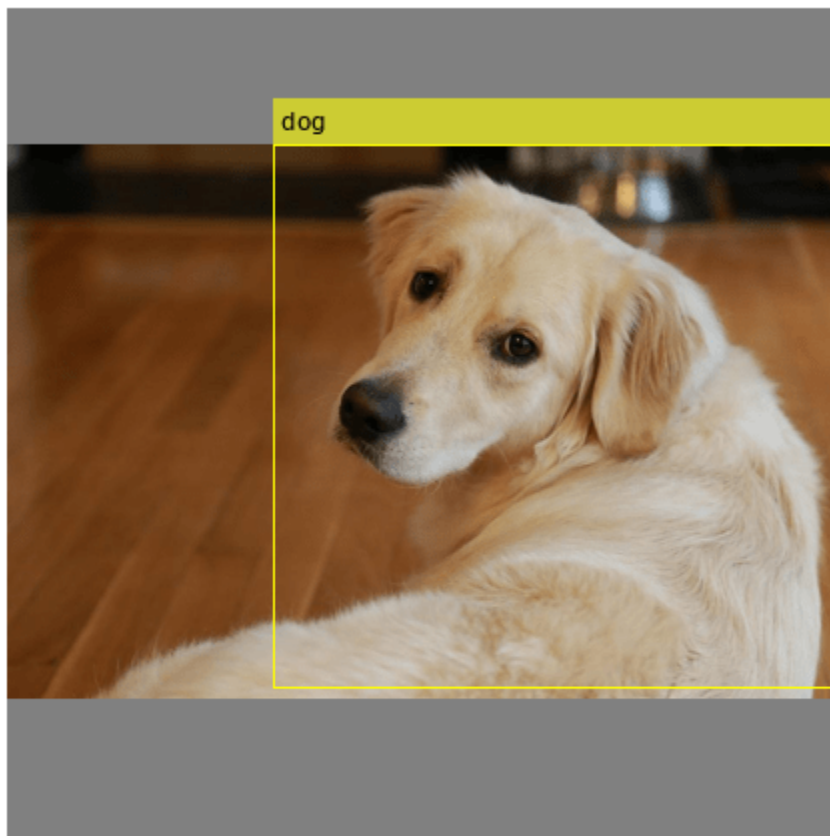

Detect Objects from Images Stored in Image Datastore

Load a pretrained YOLOv3 object detector.

```
detector = yolov3objectDetector('tiny-yolov3-coco');
```

Read the test data and store as an image datastore object.

```
location = fullfile(matlabroot,'toolbox','vision','visiondata','vehicles');
imds = imageDatastore(location);
```

Detect objects in the test dataset. Set the `Threshold` parameter value to 0.3 and `MiniBatchSize` parameter value to 32.

```
detectionResults = detect(detector,imds,'Threshold',0.3,'MiniBatchSize',32);
```

Read an image from the test dataset and extract the corresponding detection results.

```
num = 10;
I = readimage(imds,num);
bboxes = detectionResults.Boxes{num};
labels = detectionResults.Labels{num};
scores = detectionResults.Scores{num};
```

Perform non-maximal suppression to select strongest bounding boxes from the overlapping clusters. Set the `OverlapThreshold` parameter value to 0.2.

```
[bboxes,scores,labels] = selectStrongestBboxMulticlass(bboxes,scores,labels,'OverlapThreshold',0.2);
```

Display the detection results.

```
results = table(bboxes,labels,scores)
```

```
results=3x3 table
      bboxes      labels      scores
      _____  _____  _____
      14      71      52      27      car      0.93352
      74      73      7      5      car      0.65369
      102     73      15     10     car      0.85313
```

```
detectedImg = insertObjectAnnotation(I,'Rectangle',bboxes,labels);
figure
imshow(detectedImg)
```

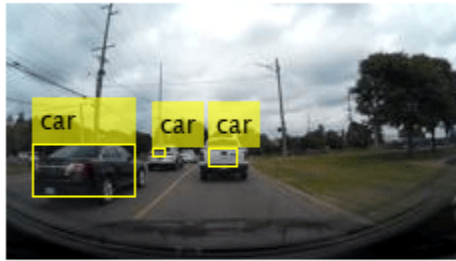

Detect Objects Within ROI

Load a pretrained YOLO v3 object detector.

```
detector = yolov3objectDetector('tiny-yolov3-coco');
```

Read a test image.

```
img = imread('highway.png');
```

Specify a region of interest (ROI) within the test image.

```
roiBox = [70 40 100 100];
```

Detect objects within the specified ROI.

```
[bboxes,scores,labels] = detect(detector,img,roiBox);
```

Display the ROI and the detection results.

```
results = table(bboxes,labels,scores)
```

```
results=1x3 table
      bboxes      labels      scores
-----
    99    103    41    33    car    0.72206
```

```
img = insertObjectAnnotation(img,'Rectangle',roiBox,'ROI','Color','blue');
```

```
detectedImg = insertObjectAnnotation(img,'Rectangle',bboxes,labels);
```

```
figure
```

```
imshow(detectedImg)
```

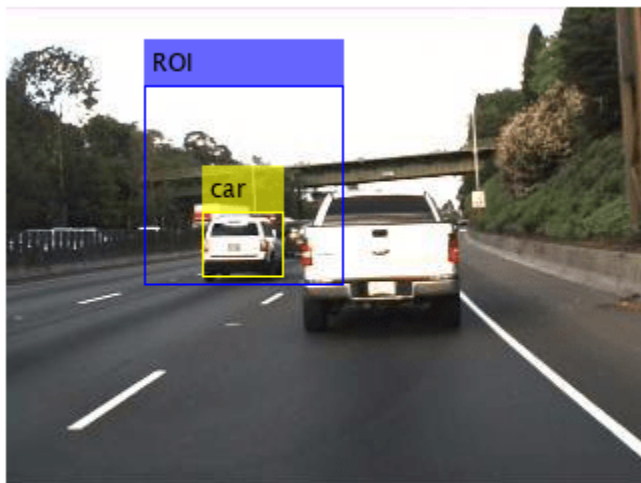

Input Arguments

detector — YOLO v3 object detector

`yolov3objectDetector` object

YOLO v3 object detector, specified as a `yolov3objectDetector` object.

I — Test images

numeric array

Test images, specified as a numeric array of size H -by- W -by- C or H -by- W -by- C -by- T . Images must be real, nonsparse, grayscale or RGB image.

- H : Height
- W : Width
- C : The channel size in each image must be equal to the network's input channel size. For example, for grayscale images, C must be equal to 1. For RGB color images, it must be equal to 3.
- T : Number of test images in the array. The function computes the object detection results for each test image in the array.

The intensity range of the test image must be similar to the intensity range of the images used to train the detector. For example, if you train the detector on `uint8` images, rescale the test image to the range $[0, 255]$ by using the `im2uint8` or `rescale` function. The size of the test image must be comparable to the sizes of the images used in training. If these sizes are very different, the detector has difficulty detecting objects because the scale of the objects in the test image differs from the scale of the objects the detector was trained to identify.

Data Types: `uint8` | `uint16` | `int16` | `double` | `single`

ds — Test images

ImageDatastore object | CombinedDatastore object | TransformedDatastore object

Test images, specified as a ImageDatastore object, CombinedDatastore object, or TransformedDatastore object containing full filenames of the test images. The images in the datastore must be grayscale, or RGB images.

roi — Search region of interest*[x y width height]* vector

Search region of interest, specified as an *[x y width height]* vector. The vector specifies the upper left corner and size of a region in pixels.

Name-Value Pair Arguments

Specify optional comma-separated pairs of Name, Value arguments. Name is the argument name and Value is the corresponding value. Name must appear inside quotes. You can specify several name and value pair arguments in any order as Name1, Value1, . . . , NameN, ValueN.

Example: `detect(detector,I,'Threshold',0.25)`

Threshold — Detection threshold

0.5 (default) | scalar in the range [0, 1]

Detection threshold, specified as a comma-separated pair consisting of 'Threshold' and a scalar in the range [0, 1]. Detections that have scores less than this threshold value are removed. To reduce false positives, increase this value.

SelectStrongest — Select strongest bounding box

true (default) | false

Select the strongest bounding box for each detected object, specified as the comma-separated pair consisting of 'SelectStrongest' and either true or false.

- true — Returns the strongest bounding box per object. The method calls the selectStrongestBboxMulticlass function, which uses nonmaximal suppression to eliminate overlapping bounding boxes based on their confidence scores.

By default, the selectStrongestBboxMulticlass function is called as follows

```
selectStrongestBboxMulticlass(bboxes,scores,...  
                             'RatioType','Union',...  
                             'OverlapThreshold',0.5);
```

- false — Return all the detected bounding boxes. You can then write your own custom method to eliminate overlapping bounding boxes.

MinSize — Minimum region size*[1 1]* (default) | vector of the form *[height width]*

Minimum region size, specified as the comma-separated pair consisting of 'MinSize' and a vector of the form *[height width]*. Units are in pixels. The minimum region size defines the size of the smallest region containing the object.

By default, MinSize is 1-by-1.

MaxSize — Maximum region size

`size(I)` (default) | vector of the form [*height width*]

Maximum region size, specified as the comma-separated pair consisting of 'MaxSize' and a vector of the form [*height width*]. Units are in pixels. The maximum region size defines the size of the largest region containing the object.

By default, 'MaxSize' is set to the height and width of the input image, `I`. To reduce computation time, set this value to the known maximum region size for the objects that can be detected in the input test image.

MiniBatchSize — Minimum batch size

128 (default) | scalar

Minimum batch size, specified as the comma-separated pair consisting of 'MiniBatchSize' and a scalar value. Use the `MiniBatchSize` to process a large collection of image. Images are grouped into minibatches and processed as a batch to improve computation efficiency. Increase the minibatch size to decrease processing time. Decrease the size to use less memory.

DetectionPreprocessing — Option to preprocess test images

'auto' (default) | 'none'

Option to preprocess the test images before performing object detection, specified as the comma-separated pair consisting of 'DetectionPreprocessing' and one of these values:

- 'auto' — To preprocess the test image before performing object detection. The `detect` function calls the `preprocess` function that perform these operations:
 - Rescales the intensity values of the training images to the range [0, 1].
 - Resizes the training images to one of the nearest network input sizes and updates the bounding box coordinate values for accurate training. The function preserves the original aspect ratio of the training data.
- 'none' — To perform object detection without preprocessing the test image. If you choose this option, the datatype of the test image must be either `single` or `double`.

Data Types: `char` | `string`

Output Arguments**bboxes — Location of objects detected**

M -by-4 matrix | T -by-1 cell array

Location of objects detected within the input image or images, returned as a

- M -by-4 matrix if the input is a single test image.
 - T -by-1 cell array if the input is an array of test images. T is the number of test images in the array. Each cell in the array contains a M -by-4 matrix specifying the bounding box detections.
- . M is the number of bounding boxes in an image.

Each row in the matrix is a four-element vector of the form [x y *width* *height*]. This vector specifies the upper left corner and size of that corresponding bounding box in pixels.

scores — Detection scores*M*- element row vector | *T*-by-1 cell array

Detection confidence scores for each bounding box, returned as a

- *M*- element row vector if the input is a single test image.
- *T*-by-1 cell array if the input is an array of test images. *T* is the number of test images in the array. Each cell in the array contains a *M*-element row vector indicating the detection scores for the corresponding bounding box.

M is the number of bounding boxes detected in an image. A higher score indicates higher confidence in the detection.

labels — Labels for bounding boxes*M*-by-1 categorical vector | *T*-by-1 cell array

Labels for bounding boxes, returned as a

- *M*-by-1 categorical array if the input is a single test image.
- *T*-by-1 cell array if the input is an array of test images. *T* is the number of test images in the array. Each cell in the array contains a *M*-by-1 categorical vector containing the names of the object classes.

M is the number of bounding boxes detected in an image.

detectionResults — Detection results

3-column table

Detection results, returned as a 3-column table with variable names, *Boxes*, *Scores*, and *Labels*. The *Boxes* column contains *M*-by-4 matrices, of *M* bounding boxes for the objects found in the image. Each row contains a bounding box as a 4-element vector in the format [*x*,*y*,*width*,*height*]. The format specifies the upper-left corner location and size in pixels of the bounding box in the corresponding image.

See Also

`predict` | `forward` | `yoloV3ObjectDetector` | `imageDatastore` | `CombinedDatastore` | `TransformedDatastore`

Topics

“Object Detection Using YOLO v3 Deep Learning”

“Getting Started with YOLO v3”

Introduced in R2021a

preprocess

Preprocess training and test images

Syntax

```
outputData = preprocess(detector,trainingData)
outputImg = preprocess(detector,img)
[ ___,scaleInfo] = preprocess( ___ )
```

Description

`outputData = preprocess(detector,trainingData)` preprocesses the training data `trainingData` before using it to train the YOLO v3 object detector. The training images and the corresponding bounding boxes are stored in the `trainingData`. The `preprocess` function performs these operations:

- Rescales the intensity values of the training images to the range [0, 1].
- Resizes the training images to one of the nearest network input sizes and updates the bounding box coordinate values for accurate training. The function preserves the original aspect ratio of the training data.

`outputImg = preprocess(detector,img)` preprocesses the test images `img` for object detection using a YOLO v3 object detector. The `preprocess` function performs these operations:

- Rescales the intensity values of the test images to the range [0, 1].
- Resizes the test images to one of the nearest network input sizes and preserves the original aspect ratio of each test image.

`[___,scaleInfo] = preprocess(___)` returns information on the scale factor applied for image resizing, in addition to any combination of arguments from previous syntaxes.

Note This function requires the Computer Vision Toolbox Model for YOLO v3 Object Detection. You can install the Computer Vision Toolbox Model for YOLO v3 Object Detection from Add-On Explorer. For more information about installing add-ons, see [Get and Manage Add-Ons](#). To run this function, you will require the Deep Learning Toolbox.

Examples

Preprocess Training Data Stored In Cell Array

Load a pretrained YOLO v3 object detector.

```
detector = yolov3objectDetector('tiny-yolov3-coco');
```

Load the training dataset into the workspace. The training data is a cell array that contains the images, bounding box values, and the class labels.

```
load('trainingData.mat','trainingData');
```

Resize the training images to the nearest network input size and rescale the intensity values by using the `preprocess` function.

```
outputData = preprocess(detector,trainingData);
```

Display the output image and the scale information used for resizing the image.

```
outputImg = outputData{1,1};  
figure  
imshow(outputImg)
```



Display the input and the preprocessed values.

```
bboxIn = cell2table(trainingData, 'VariableNames', {'Images', 'Bounding Boxes', 'Labels'})
```

```
bboxIn=3x3 table  
Images
```

	Bounding Boxes				Labels
{224x399x3 uint8}	220	136	35	28	{'vehicle'}
{224x399x3 uint8}	175	126	61	45	{'vehicle'}

```
{224×399×3 uint8} 108 120 45 33 {'vehicle'}
```

```
bboxOut = cell2table(outputData, 'VariableNames', {'Images', 'Bounding Boxes', 'Labels'})
```

```
bboxOut=3×3 table
```

Images	Bounding Boxes				Labels
{416×416×3 single}	229	232	36	29	{'vehicle'}
{416×416×3 single}	182	222	64	46	{'vehicle'}
{416×416×3 single}	112	215	47	35	{'vehicle'}

Preprocess Test Image

Load a pretrained YOLO v3 object detector.

```
detector = yolov3objectDetector('tiny-yolov3-coco');
```

Read a test image.

```
I = imread('highway.png');
```

Resize the test image to the network input size and rescale the intensity values by using the preprocess function.

```
[outputImg, scaleInfo] = preprocess(detector, I);
```

Display the output image and the scale information used for resizing the image.

```
figure
imshow(outputImg)
```

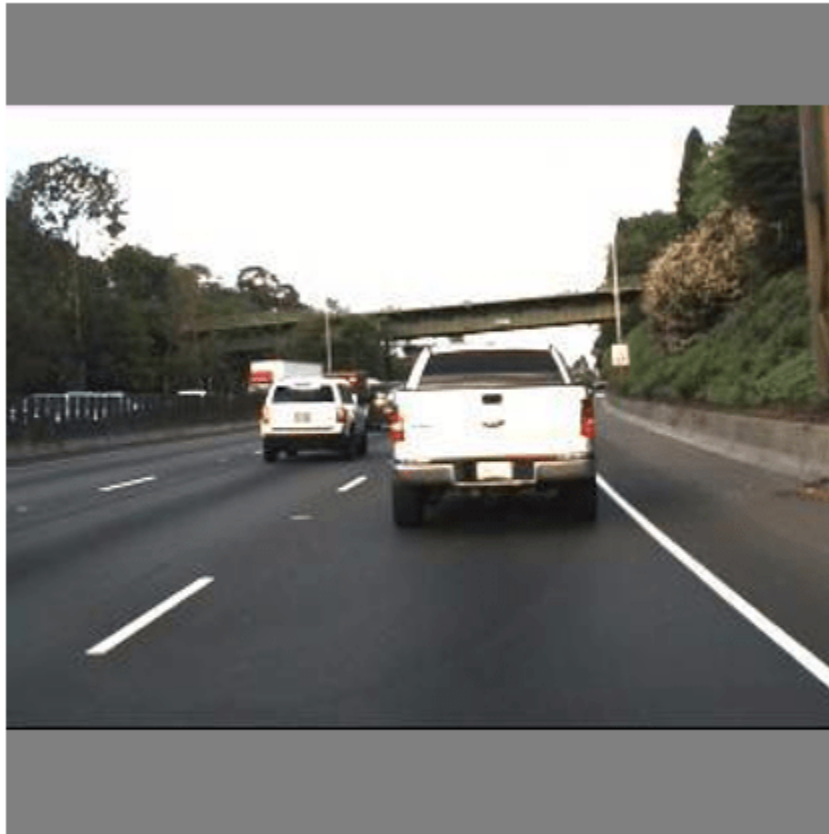

```
disp(scaleInfo)
```

```
PreprocessedImageSize: [416 416]  
ScaleX: 0.7692  
ScaleY: 0.5769
```

Input Arguments

detector — YOLO v3 object detector

`yolov3objectDetector` object

YOLO v3 object detector, specified as a `yolov3objectDetector` object.

trainingData — Training data for YOLO v3 object detector

N -by-3 cell array

Training data for YOLO v3 object detector, specified as a N -by-3 cell array that contains the images, bounding boxes, and the class labels. Each row is of the form *[images bounding boxes labels]*. N is the number of output layers in the network. The bounding boxes must be stored as a K -by-4 matrix of the form *[x y width height]*. K is the number of object classes.

img — Test images

numeric array

Test images, specified as a numeric array of size M -by- N -by- C or M -by- N -by- C -by- T . M is the number of rows, N is the number of columns, and C is the number of color channels. The value of C is 1 for grayscale images and 3 for RGB color images. T is the number of test images in the array.

Data Types: `single` | `double` | `int8` | `int16` | `int32` | `int64` | `uint8` | `uint16` | `uint32` | `uint64`

Output Arguments**outputData — Preprocessed training data** N -by-3 cell array

Preprocessed training data, returned as a N -by-3 cell array.

Data Types: `cell`

outputImg — Preprocessed test images

numeric array

Preprocessed test images, returned as a numeric array of size P -by- Q -by- C or P -by- Q -by- C -by- T . P and Q are the number of rows and columns, respectively, in the preprocessed image.

Data Types: `single`

scaleInfo — Information about scale factor for image resizing

structure

Information about the scale factor for resizing the input images, returned as a structure with fields `PreprocessedImageSize`, `ScaleX`, and `ScaleY`.

- `PreprocessedImageSize` — Size of the output resized image.
- `ScaleX` — Scale factor for resizing an image in the X -direction (along the rows).
- `ScaleY` — Scale factor for resizing an image in the Y -direction (along the columns).

Data Types: `struct`

See Also

`predict` | `forward` | `detect` | `yoloV3ObjectDetector`

Topics

“Object Detection Using YOLO v3 Deep Learning”

“Getting Started with YOLO v3”

Introduced in R2021a

predict

Compute YOLO v3 deep learning network outputs for inference

Syntax

```
output = predict(detector,dlX)
```

Description

`output = predict(detector,dlX)` computes the YOLO v3 deep learning network outputs during inference, given the detector and the test data. Use this function to get predictions from the output layers of the YOLO v3 deep learning network during inference.

Note This function requires the Computer Vision Toolbox Model for YOLO v3 Object Detection. You can install the Computer Vision Toolbox Model for YOLO v3 Object Detection from Add-On Explorer. For more information about installing add-ons, see [Get and Manage Add-Ons](#). To run this function, you will require the Deep Learning Toolbox.

Examples

Compute YOLO v3 Network Predictions

Load a pretrained YOLO v3 object detector.

```
detector = yolov3objectDetector('tiny-yolov3-coco');
```

Load the test image for prediction.

```
I = imread('highway.png');
```

Preprocess the test image and convert the preprocessed image to a formatted dlarray object.

```
[Ip,info] = preprocess(detector,I);
dlX = dlarray(Ip,'SSCB');
```

Compute predictions for the test image. The `predict` function returns the predictions for the feature maps from the output layers of the YOLO v3 deep learning network. The first column contains the confidence scores. Columns 2 to 5 contain the bounding box locations computed relative to the grid cell coordinates. The sixth column contains the class probabilities for each class used during training. The seventh and the eighth column contains the prior width and prior height of bounding boxes as computed by the network, respectively.

```
output = predict(detector,dlX)
```

```
output=2x8 cell array
    {13x13x3x1 dlarray}    {13x13x3x1 dlarray}    {13x13x3x1 dlarray}    {13x13x3x1 dlarray}
    {26x26x3x1 dlarray}    {26x26x3x1 dlarray}    {26x26x3x1 dlarray}    {26x26x3x1 dlarray}
```

You can then get the final detections by using the predictions for features with maximum objectness scores. The objectness score is the product of confidence score and class probability. To compute the exact bounding box location, you must map the predicted bounding box values to box coordinates. Alternatively, you can use the `detect` function to directly get the detection results. The `detect` function internally calls the `predict` function to compute the feature maps.

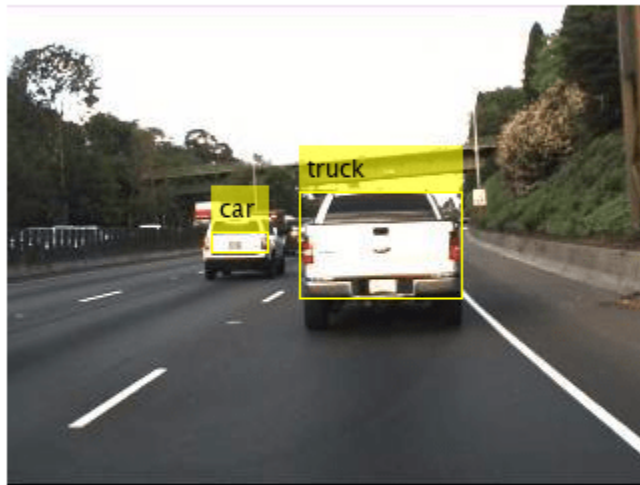

Input Arguments

detector — YOLO v3 object detector

`yoloV3ObjectDetector` object

YOLO v3 object detector, specified as a `yoloV3ObjectDetector` object.

dX — Test data

formatted `dArray`

Test data, specified as a formatted `dArray` object. The test data can contain one or more test images.

Output Arguments

output — Output predictions

N -by-8 cell array of formatted `dArray`

Output predictions, returned as an N -by-8 cell array of formatted `dArray` objects. N is the number of output layers in the YOLO v3 deep learning network. Each row in the cell array is of form $[conf\ b_x\ b_y\ b_w\ b_h\ prob\ t_w\ t_h]$. The function returns predictions as a formatted `dArray` value..

Predictions	Description
-------------	-------------

<i>conf</i>	Confidence scores for each bounding box.
<i>b_x</i>	X-coordinate of the center of the predicted bounding box relative to the location of the grid cell.
<i>b_y</i>	Y-coordinate of the center of the predicted bounding box relative to the location of the grid cell.
<i>b_w</i>	Width of the predicted bounding box relative to the location of the grid cell.
<i>b_h</i>	Height of the predicted bounding boxes relative to the location of the grid cell.
<i>prob</i>	Class probabilities predicted for each feature in the output feature map.
<i>t_w</i>	Prior width of the bounding boxes as computed by the network.
<i>t_h</i>	Prior height of the bounding boxes as computed by the network.

See Also

`forward` | `yolo3ObjectDetector` | `preprocess` | `detect`

Topics

“Object Detection Using YOLO v3 Deep Learning”

“Getting Started with YOLO v3”

Introduced in R2021a

forward

Compute YOLO v3 deep learning network output for training

Syntax

```
features = forward(detector,dlX)
[features,activations] = forward(detector,dlX)
[features,activations,state] = forward(detector,dlX)
```

Description

`features = forward(detector,dlX)` computes the output features of the network during training given the input data `dlX`.

`[features,activations] = forward(detector,dlX)` also computes the activations of the network that you can use for modelling the gradient loss.

`[features,activations,state] = forward(detector,dlX)` also returns the updated network state.

Note This function requires the Computer Vision Toolbox Model for YOLO v3 Object Detection. You can install the Computer Vision Toolbox Model for YOLO v3 Object Detection from Add-On Explorer. For more information about installing add-ons, see [Get and Manage Add-Ons](#). To run this function, you will require the Deep Learning Toolbox.

Examples

Compute YOLO v3 Network Output During Forward Pass

Load a pretrained YOLO v3 object detector.

```
detector = yolov3objectDetector('tiny-yolov3-coco');
```

Read an image to use for training.

```
I = imread('highway.png');
```

Preprocess the training data and convert the preprocessed training data to a formatted `darray` object.

```
[Ip,info] = preprocess(detector,I);
dlX = darray(Ip,'SSCB');
```

Compute the network outputs obtained during training. The `forward` function returns the activations from the output layers of the YOLO v3 deep learning network. The first column contains the confidence scores. Columns 2 to 5 contain the bounding box locations computed relative to the grid cell coordinates. The sixth column contains the class probabilities for each class used during training. The seventh and the eighth column contains the prior width and prior height of bounding boxes as

computed by the network, respectively. The output features computed during the forward pass are used to model the gradient losses for the network.

```
[output, activations, state] = forward(detector, dLX)
```

```
output=2×8 cell array
```

```
  {13×13×3 single}   {13×13×3 single}   {13×13×3 single}   {13×13×3 single}   {13×13×3 single}
  {26×26×3 single}   {26×26×3 single}   {26×26×3 single}   {26×26×3 single}   {26×26×3 single}
```

```
activations=2×8 cell array
```

```
  {13×13×3×1 dlarray} {13×13×3×1 dlarray} {13×13×3×1 dlarray} {13×13×3×1 dlarray}
  {26×26×3×1 dlarray} {26×26×3×1 dlarray} {26×26×3×1 dlarray} {26×26×3×1 dlarray}
```

```
state=22×3 table
```

Layer	Parameter	Value
"batch_norm_1"	"TrainedMean"	{1×1×16 dlarray}
"batch_norm_1"	"TrainedVariance"	{1×1×16 dlarray}
"batch_norm_2"	"TrainedMean"	{1×1×32 dlarray}
"batch_norm_2"	"TrainedVariance"	{1×1×32 dlarray}
"batch_norm_3"	"TrainedMean"	{1×1×64 dlarray}
"batch_norm_3"	"TrainedVariance"	{1×1×64 dlarray}
"batch_norm_4"	"TrainedMean"	{1×1×128 dlarray}
"batch_norm_4"	"TrainedVariance"	{1×1×128 dlarray}
"batch_norm_5"	"TrainedMean"	{1×1×256 dlarray}
"batch_norm_5"	"TrainedVariance"	{1×1×256 dlarray}
"batch_norm_6"	"TrainedMean"	{1×1×512 dlarray}
"batch_norm_6"	"TrainedVariance"	{1×1×512 dlarray}
"batch_norm_7"	"TrainedMean"	{1×1×1024 dlarray}
"batch_norm_7"	"TrainedVariance"	{1×1×1024 dlarray}
"batch_norm_8"	"TrainedMean"	{1×1×256 dlarray}
"batch_norm_8"	"TrainedVariance"	{1×1×256 dlarray}
⋮		

Input Arguments

detector — YOLO v3 object detector

YOLOv3ObjectDetector object

YOLO v3 object detector, specified as a `YOLOv3ObjectDetector` object.

dLX — Training data

formatted dlarray

Training data, specified as a formatted dlarray object.

Output Arguments

features — Output features in box coordinates

N-by-8 cell array

Output features in box coordinates, returned as an N -by-8 cell array. N is the number of output layers in the YOLO v3 deep learning network.

activations — Activations of network

N -by-8 cell array of formatted `darray`

Activations of the network, returned as an N -by-8 cell array of formatted `darray` objects. N is the number of output layers in the YOLO v3 deep learning network.

Each row in the cell array is of form `[conf bx by bw bh prob tw th]`. The function returns each activation as a formatted `darray` value.

Activations	Description
<code>conf</code>	Estimated confidence scores for each bounding box.
<code>b_x</code>	Estimated X-coordinate value for the center of the bounding box relative to the location of the grid cell.
<code>b_y</code>	Estimated Y-coordinate value for the center of the bounding box relative to the location of the grid cell.
<code>b_w</code>	Estimated width of the bounding box relative to the location of the grid cell.
<code>b_h</code>	Estimated height of the bounding box relative to the location of the grid cell.
<code>prob</code>	Class probabilities estimated for each feature in the output feature map.
<code>t_w</code>	Prior width of the bounding box as estimated by the network.
<code>t_h</code>	Prior height of the bounding box as estimated by the network.

state — Updated network state

table

Updated network state, returned as a table. The network state is a table with three columns:

- `Layer` - Layer name, returned as a string scalar.
- `Parameter` - Parameter name, returned as a string scalar.
- `Value` - Value of parameter, returned as a numeric array object.

The network state contains information remembered by the network between iterations.

See Also

`yolov3objectDetector` | `preprocess` | `detect`

Topics

“Object Detection Using YOLO v3 Deep Learning”

“Getting Started with YOLO v3”

Introduced in R2021a

vision.ChromaResampler

Package: vision

Downsample or upsample chrominance components of images

Description

To downsample or upsample chrominance components of images:

- 1 Create the `vision.ChromaResampler` object and set its properties.
- 2 Call the object with arguments, as if it were a function.

To learn more about how System objects work, see [What Are System Objects?](#)

Creation

Syntax

```
resampler = vision.ChromaResampler
gammaCorr = vision.ChromaResampler(Name, Value)
```

Description

`resampler = vision.ChromaResampler` returns a chroma resampling object, `Cresampler`, that downsamples or upsamples chroma components of a YCbCr signal to reduce the bandwidth and storage requirements.

`gammaCorr = vision.ChromaResampler(Name, Value)` sets properties using one or more name-value pairs. Enclose each property name in quotes. For example, `resampler = vision.ChromaResampler('InterpolationFilter', 'Linear')`

Properties

Unless otherwise indicated, properties are *nontunable*, which means you cannot change their values after calling the object. Objects lock when you call them, and the `release` function unlocks them.

If a property is *tunable*, you can change its value at any time.

For more information on changing property values, see [System Design in MATLAB Using System Objects](#).

Resampling — Resampling format

'4:4:4 to 4:2:2' (default) | resample format

Resampling format, specified as one of the following:

```
'4:4:4 to 4:2:2'
'4:4:4 to 4:2:0 (MPEG1)'
```

```
'4:4:4 to 4:2:0 (MPEG2) '  
'4:4:4 to 4:1:1 '  
'4:2:2 to 4:2:0 (MPEG1) '  
'4:2:2 to 4:2:0 (MPEG2) '
```

To upsample the chrominance components of images, set this property to one of the following:

```
'4:2:2 to 4:4:4 '  
'4:2:0 (MPEG1) to 4:4:4 '  
'4:2:0 (MPEG2) to 4:4:4 '  
'4:1:1 to 4:4:4 '  
'4:2:0 (MPEG1) to 4:2:2 '  
'4:2:0 (MPEG2) to 4:2:2 '
```

InterpolationFilter — Method used to approximate missing values

Pixel replication (default) | Linear

Method used to approximate missing values, specified as `Pixel replication` or `Linear`. The default is `Linear`. When you set this property to `Linear`, the object uses linear interpolation to calculate the missing values. When you set this property to `Pixel replication`, the object replicates the chrominance values of the neighboring pixels to create the upsampled image. This property applies when you upsample the chrominance values.

AntialiasingFilterSource — Lowpass filter used to prevent aliasing

Auto (default) | Property | None

Lowpass filter used to prevent aliasing, specified as `Auto`, `Property`, or `None`. When you set this property to `Auto`, the object uses a built-in lowpass filter. When you set this property to `Property`, the coefficients of the filters are specified by the `HorizontalFilterCoefficients` and `VerticalFilterCoefficients` properties. When you set this property to `None`, the object does not filter the input signal. This property applies when you downsample the chrominance values.

HorizontalFilterCoefficients — Horizontal filter coefficients

[0.2 0.6 0.2] (default) | three-element vector

Horizontal filter coefficients, specified as a three-element vector. This property applies when you set the `Resampling` property to one of `[4:4:4 to 4:2:2]` | `[4:4:4 to 4:2:0 (MPEG1)]` | `[4:4:4 to 4:2:0 (MPEG2)]` | `[4:4:4 to 4:1:1]` and the `AntialiasingFilterSource` property to `Property`.

VerticalFilterCoefficients — Specify the filter coefficients to apply to the input signal

[0.5 0.5] (default) | two-element vector

Specify the filter coefficients to apply to the input signal, specify as a two-element vector. This property applies when you set the `Resampling` property to one of `[4:4:4 to 4:2:0 (MPEG1)]` | `[4:4:4 to 4:2:0 (MPEG2)]` | `[4:2:2 to 4:2:0 (MPEG1)]` | `[4:2:2 to 4:2:0 (MPEG2)]` and the `AntialiasingFilterSource` property to `Property`.

TransposedInput — Input is row-major format

false (default) | true

Input is row-major format, specified as `true` or `false`. Set this property to `true` when the input contains data elements from the first row first, then data elements from the second row second, and so on through the last row. Otherwise, the object assumes that the input data is stored in column-major format.

Usage

Syntax

```
[Cb1,Cr1] = resampler(Cb,Cr)
```

Description

[Cb1,Cr1] = resampler(Cb,Cr) resamples the input chrominance components Cb and Cr and returns Cb1 and Cr1, as the resampled outputs.

Input Arguments

Cb1 — Chrominance component

matrix

Chrominance component of an image, specified as a matrix.

Cr2 — Chrominance component

matrix

Chrominance component of an image, specified as a matrix.

Output Arguments

Cb1 — Resampled chrominance component

same as input (default)

Chrominance component of an image, returned as a matrix.

Cr1 — Resampled chrominance component

same as input (default)

Chrominance component of an image, returned as a matrix.

Object Functions

To use an object function, specify the System object as the first input argument. For example, to release system resources of a System object named obj, use this syntax:

```
release(obj)
```

Common to All System Objects

step	Run System object algorithm
release	Release resources and allow changes to System object property values and input characteristics
reset	Reset internal states of System object

Examples

Resample Chrominance Components of Image

Create a resampler object

```
resampler = vision.ChromaResampler;
```

Read an RGB image and convert it to YCbCr.

```
imageRGB = imread('peppers.png');  
imageYCbCr = rgb2ycbcr(imageRGB);
```

Resample the Cb and Cr chrominance components.

```
[Cb,Cr] = resampler(imageYCbCr(:,:,2), imageYCbCr(:,:,3));
```

Extended Capabilities

C/C++ Code Generation

Generate C and C++ code using MATLAB® Coder™.

Usage notes and limitations:

- See “System Objects in MATLAB Code Generation” (MATLAB Coder).

See Also

rgb2ycbcr

Introduced in R2012a

groundTruthDataSource

Object for storing ground truth data sources

Description

The `groundTruthDataSource` object defines the source of ground truth data. Use this object to specify a data source for the `groundTruth` object. To label the data source, load the `groundTruthDataSource` object into a labeling app.

- The **Image Labeler** supports data sources for collections of images.
- The **Video Labeler** supports data sources for videos and image sequences. This app also supports custom data sources.

Creation

Syntax

```
gtSource = groundTruthDataSource(imds)
```

```
gtSource = groundTruthDataSource(imageFiles)
```

```
gtSource = groundTruthDataSource(videoName)
```

```
gtSource = groundTruthDataSource(imageSeqFolder)
```

```
gtSource = groundTruthDataSource(imageSeqFolder, timestamps)
```

```
gtSource = groundTruthDataSource(sourceName, readerFcn, timestamps)
```

Description

Image Datastore Source

`gtSource = groundTruthDataSource(imds)` returns a ground truth data source object for an `imageDatastore` specified by `imds`.

Collection of Images Source

`gtSource = groundTruthDataSource(imageFiles)` returns a ground truth data source object for a collection of images specified by `imageFiles`. Images must be in a file format readable by `imread`.

Video File Source

`gtSource = groundTruthDataSource(videoName)` returns a ground truth data source object for a video file specified by `videoName`. Videos must be in a file format readable by `VideoReader`.

Video as a Sequence of Images Source

`gtSource = groundTruthDataSource(imageSeqFolder)` returns a ground truth data source object for an image sequence located in the folder specified by `imageSeqFolder`.

`gtSource = groundTruthDataSource(imageSeqFolder, timestamps)` returns a ground truth data source object for an image sequence with a corresponding timestamp for each image contained in the specified folder. `timestamps` sets the `TimeStamps` property.

Custom Data Source

`gtSource = groundTruthDataSource(sourceName, readerFcn, timestamps)` returns a ground truth data source object by using the custom reader function handle, `readerFcn`. `sourceName` sets the `Source` property and `timestamps` set the `TimeStamps` property. The custom reader function loads an image from `sourceName` that corresponds to the current timestamp specified in the duration vector `timestamps`.

Input Arguments

imds — Image datastore

imagedatastore object

Image datastore, specified as an `imageDatastore` object.

imageFiles — Image file names

string array | cell array of character vectors

Image file names, specified as a string array or a cell array of character vectors. Images must be in a file format readable by `imread`. For a list of the supported image file formats, see `imformats`.

videoName — Name of video file

string scalar | character vector

Name of video file, specified as a string scalar or character vector. Videos must be in a file format readable by `VideoReader`. For a list of the supported video file formats, see `VideoReader.getFileFormats`. If your video format is not supported, specify a custom reader function, `readerFcn`.

imageSeqFolder — Image sequence folder

string scalar | character vector

Image sequence folder, specified as a string scalar or a character vector. The image files name extensions must be supported by `imformats`. If your video format is not supported, specify a custom reader function, `readerFcn`.

The images are loaded in the order returned by the `dir` command.

readerFcn — Custom reader function

function handle

Custom reader function, specified as a function handle. The custom reader function must load an image from a source at a specified timestamp by using this syntax:

```
outputImage = readerFcn(sourceName, currentTimestamp)
```

- `readerFcn` is the name of your custom reader function.
- `sourceName` is the name of the data source.
- `currentTimestamp` is the current timestamp, as specified by the input vector `timestamp`.

The `outputImage` returned by the custom function must be a grayscale or RGB image in any format supported by `imshow`. For more information, see “Use Custom Image Source Reader for Labeling”.

Properties

TimeStamps — Timestamps of video or image sequence

`duration` vector

This property is read-only.

Timestamps of video or image sequence, specified as a `duration` vector.

- For a video file, `TimeStamps` is automatically populated with the timestamps that are present for the video frames.
- For an image sequence or custom reader, `TimeStamps` is populated with the values in the input `duration` vector `timestamps`.
- For an image collection, the `TimeStamps` property remains empty.

.

Source — Source of ground truth data

character vector | cell array of character vectors

This property is read-only.

Source of ground truth data, specified as a character vector or cell array of character vectors. The source name can refer to image file names, a video file name, image sequence file names, or custom data source names.

Examples

Create Data Source From Image Datastore

Load image collection file names.

```
imageDir = fullfile(matlabroot, 'toolbox', 'vision', 'visiondata', 'bookCovers');
imds = imageDatastore(imageDir);
```

Create a data source from an image datastore.

```
dataSource = groundTruthDataSource(imds);
```

Read and display an image from the datastore.

```
I = read(dataSource.Source);
figure, imshow(I)
```

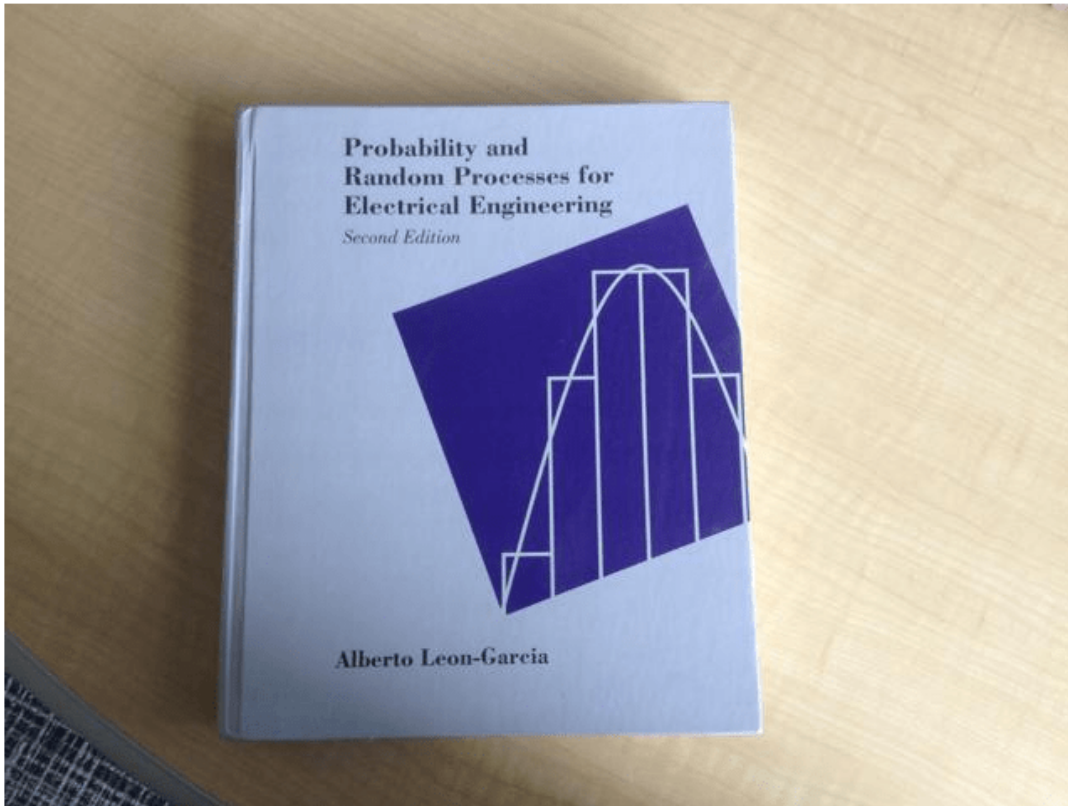

Create a Ground Truth Data Source From a Video File

Use the `groundTruthDataSource` object to create a data source.

Read a video file and create a data source.

```
videoName = 'vipunmarkedroad.avi';  
dataSource = groundTruthDataSource(videoName)
```

```
dataSource =  
groundTruthDataSource for a video file with properties
```

```
    Source: ...t\lab\toolbox\vision\visiondata\vipunmarkedroad.avi  
    TimeStamps: [84x1 duration]
```

Create a `VideoReader` to read the video frames.

```
reader = VideoReader(videoName);
```

Read the 5th frame in the video and display

```
timeStamp = seconds(dataSource.TimeStamps(5));
reader.CurrentTime = timeStamp;
I = readFrame(reader);
```

```
figure
imshow(I)
```



Create Data Source From Image Sequence

Create a ground truth data source from an image sequence stored in a specified folder.

Specify the folder containing a sequence of images.

```
imageDir = fullfile(matlabroot,'toolbox','vision',...
    'visiondata','building');
```

Create a data source for the images that are in the `imageDir` folder.

```
dataSource = groundTruthDataSource(imageDir)
```

```
dataSource =
groundTruthDataSource for a video as an image sequence with properties
```

```
Source: {
    'B:\matlab\toolbox\vision\visiondata\building\building1.JPG';
    'B:\matlab\toolbox\vision\visiondata\building\building2.JPG';
    'B:\matlab\toolbox\vision\visiondata\building\building3.JPG'
    ... and 2 more
}
TimeStamps: [5x1 duration]
```

Read the 5th frame in the sequence.

```
I = imread(dataSource.Source{5});  
figure  
imshow(I)
```



Create Data Source Using Custom Reader

Create a ground truth data source by using a custom reader function.

Specify an image folder containing a sequence of road images.

```
imgFolder = fullfile(matlabroot, 'toolbox', 'vision', 'visiondata', 'building');
```

Use an image datastore as the custom data source.

```
imgDataStore = imageDatastore(imgFolder);
```

Write a reader function, `readerFcn`, to read images from the datastore. The first input argument, `sourceName`, is not used. The second input argument, `currentTimestamp`, is the current timestamp. The function converts `currentTimestamp` from a duration scalar to a 1-based index suitable for reading images from the datastore.

```
readerFcn = @(~,idx)readimage(imgDataStore,seconds(idx));
```

Create a data source for the images in the image folder by using the custom reader function.

```
dataSource = groundTruthDataSource(imgFolder,readerFcn,1:5)
```

```
dataSource =  
groundTruthDataSource for a custom data source with properties
```

```
    Source: B:\matlab\toolbox\vision\visiondata\building  
    TimeStamps: [5x1 duration]
```

Read the fifth frame in the sequence.

```
I = readerFcn(imgFolder,seconds(5));  
figure  
imshow(I)
```



Tips

- groundTruth objects for video-based groundTruthDataSource objects rely on the video reading capabilities of your operating system. A groundTruth object created using a video data

source remains consistent only for the same platform that was used to create it. To create a platform-specific `groundTruth` object, convert the video into a sequence of images.

See Also

Apps

Ground Truth Labeler | **Image Labeler** | **Video Labeler**

Functions

`groundTruth` | `labelType` | `objectDetectorTrainingData` | `imageDatastore` | `duration`

Topics

“Get Started with the Image Labeler”

“Get Started with the Video Labeler”

“Use Custom Image Source Reader for Labeling”

“Create Automation Algorithm for Labeling”

“Training Data for Object Detection and Semantic Segmentation”

Introduced in R2017a

groundTruth

Ground truth label data

Description

The `groundTruth` object contains information about the data source, label definitions, and marked label annotations for a set of ground truth labels. You can export or import a `groundTruth` object from the **Image Labeler** and **Video Labeler** apps.

- To create training data for an object detector from arrays of `groundTruth` objects, use the `objectDetectorTrainingData` function.
- To create training data for a semantic segmentation network from arrays of `groundTruth` objects, use the `pixelLabelTrainingData` function.

Creation

To export a `groundTruth` object from a labeling app, on the app toolstrip, select **Export Labels > To Workspace**. The app exports the object to the MATLAB workspace. To create a `groundTruth` object programmatically, use the `groundTruth` function (described here).

Syntax

```
gTruth = groundTruth(dataSource, labelDefs, labelData)
```

Description

`gTruth = groundTruth(dataSource, labelDefs, labelData)` returns an object containing ground truth labels that can be imported into the **Image Labeler** and **Video Labeler** apps.

- `dataSource` specifies the source of the ground truth data and sets the `DataSource` property.
- `labelDefs` specifies the label, sublabel, and attribute definitions of the ground truth data and sets the `LabelDefinitions` property.
- `labelData` specifies the identifying information, position, and timestamps for marked labels and sets the `LabelData` property.

Properties

DataSource — Source of ground truth data

`groundTruthDataSource` object

Source of ground truth data, specified as a `groundTruthDataSource` object. The object contains information that describes the video, image sequence, or custom data source from which ground truth data was labeled.

To access images from the original data source, use `VideoReader` or `imageDatastore`. You can also use a custom read function. For more details, see “Use Custom Image Source Reader for Labeling”.

LabelDefinitions — Label definitions

table

This property is read-only.

Label definitions, specified as a table. To create this table, use one of these options.

- In one of the labeling apps, create label definitions, and then export them as part of a `groundTruth` object.
- Use a `labelDefinitionCreator` object to generate a label definitions table. If you save this table to a MAT-file, you can then load the label definitions into a labeling app session by selecting **Load > Label Definitions** from the app toolstrip.
- Create the label definitions table at the MATLAB command line.

This table describes the required and optional columns of the table specified in the `LabelDefinitions` property.

Column	Description	Required or Optional
Name	Strings or character vectors specifying the name of each label definition.	Required
Type	<code>labelType</code> enumerations that specify the type of each label definition, such as <code>Rectangle</code> or <code>Scene</code> .	Required

Column	Description	Required or Optional
LabelColor	1-by-3 row vectors of RGB triplets that specify the colors of the label definitions. Values are in the range [0, 1]. The color yellow (RGB triplet [1 1 0]) is reserved for the color of selected labels in the labeling apps.	<p>Optional</p> <p>When you define labels in a labeling app, you must specify a color. Therefore, an exported label definitions table always includes this column.</p> <p>When you create label definitions using the <code>labelDefinitionCreator</code> object without specifying colors, the returned label definitions table includes this column, but all column values are empty.</p>

Column	Description	Required or Optional
PixelLabelID	Scalars, column vectors, or <i>M</i> -by-3 matrices of integer-valued label IDs. PixelLabelID specifies the pixel label values used to represent a label definition. Pixel label ID values must be between 0 and 255.	<p>Optional</p> <p>When you define pixel labels in a labeling app or the <code>labelDefinitionCreator</code> object, the generated label definitions table includes this column.</p> <p>When creating a label definitions table at the MATLAB command line, if you set <code>Type</code> to <code>labelType.PixelLabel</code> for any label, then this column is required.</p>

Column	Description	Required or Optional
Group	Strings or character vectors specifying the group to which each label definition belongs.	<p data-bbox="1276 327 1382 359">Optional</p> <p data-bbox="1276 390 1463 705">If you create the label definitions table at the MATLAB command line, you do not need to include a Group column.</p> <p data-bbox="1276 737 1463 1396">If you export label definitions from a labeling app or create them using a <code>labelDefinitionCreator</code> object, the label definitions table includes this column, even if you did not specify groups. The app assigns each label definition a Group value of <code>'None'</code>.</p>

Column	Description	Required or Optional
Description	Strings or character vectors that describe each label definition.	<p>Optional</p> <p>If you create the label definitions table at the MATLAB command line, you do not need to include a Description column.</p> <p>If you export label definitions from a labeling app or create them using a <code>labelDefinitionCreator</code> object, the label definitions table includes this column, even if you did not specify descriptions. The Description for these label definitions is an empty character vector.</p>
Hierarchy	Structures containing sublabel and attribute data for each label definition. For an example of the Hierarchy format, see “Get Started with the Image Labeler” or “Get Started with the Video Labeler”.	<p>Optional</p> <p>In labeling apps, when you define sublabels or attributes, the exported <code>groundTruth</code> object includes this column.</p>

For example, consider a table with label definitions named Sky, Vegetation, Lanes, StopSign, and Vehicle, and that was exported from the **Video Labeler** app.

```
>> gTruth.LabelDefinitions
```

```
ans =
```

```
5x6 table
```

Name	Type	LabelColor	PixelLabelID	Group	Description
{'Sky' }	PixelLabel	{1x3 double}	{[1]}	{'None'}	{0x0 char}
{'Vegetation'}	PixelLabel	{1x3 double}	{[2]}	{'None'}	{0x0 char}
{'Lanes' }	Line	{1x3 double}	{0x0 double}	{'None'}	{0x0 char}
{'StopSign' }	Rectangle	{1x3 double}	{0x0 double}	{'None'}	{0x0 char}
{'Vehicle' }	ProjectedCuboid	{1x3 double}	{0x0 double}	{'None'}	{0x0 char}

- The label definitions include pixel labels, so the table includes a PixelLabelID column.
- Two of the labels contain attributes, so the app created a Hierarchy column that applies across all label definitions.
- The label definitions do not have assigned groups, so the Group column is 'None' for all label definitions.

Note Labeler apps can only load pixel data that have pixel IDs between 1 and 255.

LabelData — Label data for each ROI and scene label

`table` | `timetable`

This property is read-only.

Label data for each ROI and scene label, specified as a `table` for image collections or a `timetable` for videos or image sequences. Each column of `LabelData` holds labels for a single label definition and corresponds to the `Name` value for each row in `LabelDefinitions`. These `LabelData` describes the elements of the table. The label categories are specified as `labelType` enumerations.

Alternatively, for ROI label data that is grouped by label type, a single column labeled `ROILabelData`, can be used and specified as a structure containing at least one label type, `RectangleData`, `PolygonData`, `LineData`, or `ProjCuboidData`.

The storage format for each label type is described in the table.

Label Type	Storage Format for Labels at Each Timestamp
labelType.Rectangle	<p>M-by-4 numeric matrix of the form [x, y, w, h], where:</p> <ul style="list-style-type: none">• M is the number of labels in the frame.• x and y specify the upper-left corner of the rectangle.• w specifies the width of the rectangle, which is its length along the x-axis.• h specifies the height of the rectangle, which is its length along the y-axis.

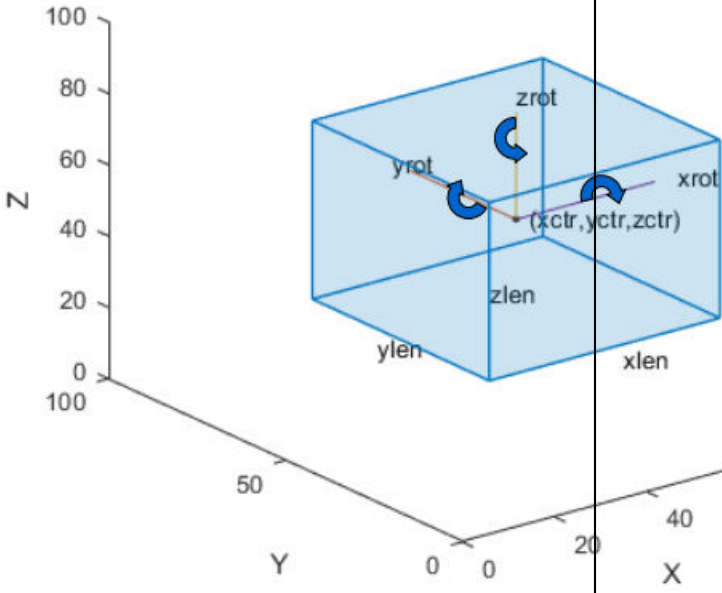
Label Type	Storage Format for Labels at Each Timestamp
labelType.Cuboid	<p>M-by-9 numeric matrix with rows of the form [xctr, yctr, zctr, xlen, ylen, zlen, xrot, yrot, zrot], where:</p> <ul style="list-style-type: none"> • M is the number of labels in the frame. • xctr, yctr, and zctr specify the center of the cuboid. • xlen, ylen, and zlen specify the length of the cuboid along the x-axis, y-axis, and z-axis, respectively, before rotation has been applied. • xrot, yrot, and zrot specify the rotation angles for the cuboid along the x-axis, y-axis, and z-axis, respectively. These angles are clockwise-positive when looking in the forward direction of their corresponding axes. <p>The figure shows how these values determine the position of a cuboid.</p> 

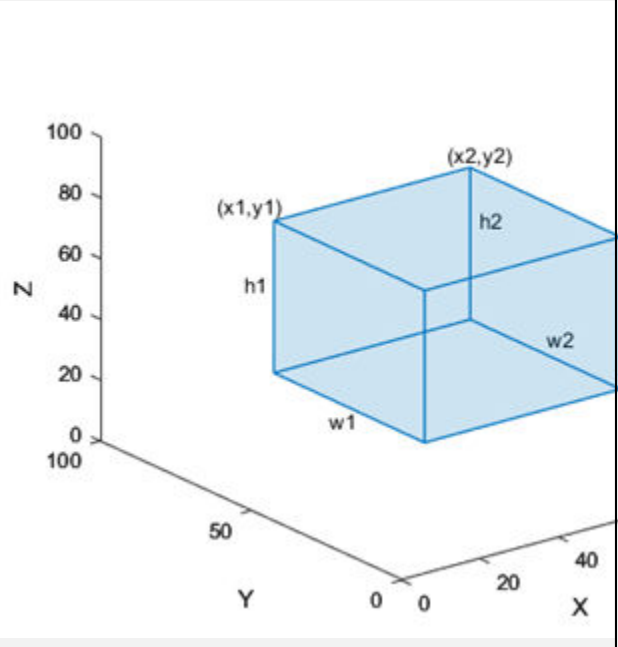
Label Type	Storage Format for Labels at Each Timestamp
<p>labelType.ProjectectedCuboid</p>	<p>M-by-8 vector of the form [x1, y1, w1, h1, x2, y2, w2, h2], where:</p> <ul style="list-style-type: none"> • M is the number of labels in the frame. • x1, y1 specifies the x,y coordinates for the upper-left location of the front-face of the projected cuboid • w1 specifies the width for the front-face of the projected cuboid. • h1 specifies the height for the front-face of the projected cuboid. • x2, y2 specifies the x,y coordinates for the upper-left location of the back-face of the projected cuboid. • w2 specifies the width for the back-face of the projected cuboid. • h2 specifies the height for the back-face of the projected cuboid. <p>The figure shows how these values determine the position of a cuboid.</p> 
<p>labelType.Line</p>	<p>M-by-1 vector of cell arrays, where M is the number of labels in the frame. Each cell array contains an N-by-2 numeric matrix of the form [x1 y1; x2 y2; ... ; xN yN] for N points in the polyline.</p>

Label Type	Storage Format for Labels at Each Timestamp
labelType.PixelLabel	Label data for all pixel label definitions is stored in a single M -by-1 <code>PixelLabelData</code> column for M images or frames. Each element contains a filename for a pixel label image. A pixel label image describes the label or labels contained in the corresponding image. The labels can be described as a 1- or 3- channel label matrix. To use <code>PixelLabelData</code> with any of the labeler apps, you must use a single-channel label matrix, where the values are of type <code>uint8</code> . You can convert a 3-channel pixel label data matrix to a single-channel label matrix programmatically to use with the labeler apps.
labelType.Polygon	M -by-1 vector of cell arrays, where M is the number of labels. Each cell array contains an N -by-2 numeric matrix of the form $[x1\ y1; x2\ y2; \dots; xN\ yN]$ for N points in the polygon.
labelType.Custom	Labels are stored exactly as they are specified in the timetable. If you import a <code>groundTruthMultisignal</code> object containing custom label data into the Ground Truth Labeler app, this data is not imported into the app. Use custom data when gathering label data for training and combining it with data labeled in the app.

Supported GroundTruth Objects

	Video Labeler App	Image Labeler App
Data source	Video file, image sequence folder, custom reader	Image files
Label definitions	Rectangle, Line, PixelLabel, or Scene label types	Rectangle, Line, PixelLabel, or Scene label types
Label data	Timetable of Rectangle, Line, PixelLabel, or Scene label types	Table (no timetable) for Rectangle, Line, PixelLabel, or Scene label types

Labels, sublabels, and attributes per frame are stored in structs

gTruth		gTruth.LabelData			
gTruth.LabelData					
	Time	1 Vehicles	2 LaneMarkers	3 Signs	4
1	0 sec	1x2 struct	1x2 struct	1x4 struct	
2	0.05 sec	1x5 struct	1x2 struct	1x2 struct	
3	0.1 sec	1x4 struct	1x3 struct	1x5 struct	
4	0.15 sec	1x0 struct	1x0 struct	1x0 struct	

At time interval: 0.05 sec, there are:
5 Vehicles, 2 LaneMarkers, and 2 Signs labels marked in the scene

Position, attribute data, and sublabel structs for the 5 vehicles labeled at interval 0.05 sec

gTruth		gTruth.LabelData		gTruth.LabelData.Vehicles(2,1)						
gTruth.LabelData.Vehicles(2,1)										
Fields	Position	vehicleColor	vehicleType	door	wheel	rearWindow	headLight	rearBrakeLight		
1	[251,196,182,92]	'gray'	'smallTruck'	1x3 struct	[]	[]	[]	[]		
2	[498,181,131,115]	'black'	'SUV'	1x1 struct	1x1 struct	1x2 struct	[]	1x2 struct		
3	[373,262,1,1]	'white'	'sedan'	[]	[]	[]	[]	[]		
4	[1,189,171,50]	'white'	'sedan'	1x1 struct	1x2 struct	1x1 struct	1x1 struct	1x1 struct		
5	[137,282,273,152]	'red'	'van'	[]	1x2 struct	[]	1x2 struct	[]		
6										

Position of a door belonging to white sedan vehicle

gTruth.LabelData.Vehicles(2,1)(4).door	
Field	Value
Position	[135,205,21,23]

To add ground truth data that is not an ROI (Rectangle, Line, PixelLabel) or Scene label category to a groundTruth object, provide a label definition with a labelType that is Custom. The custom data is not visible when you load it into the labeling app.

Object Functions

selectLabelsByGroup	Select ground truth labels by label group
selectLabelsByType	Select ground truth labels by label type
selectLabelsByName	Select ground truth labels by label name
changeFilePaths	Change file paths in ground truth data
gatherLabelData	Gather label data from ground truth

Examples

Create Ground Truth for Stop Signs and Cars

Create a data source from a collection of images.

```
data = load('stopSignsAndCars.mat');
imageFileNames = data.stopSignsAndCars.imageFilename(1:2)

imageFileNames = 2x1 cell
    {'stopSignImages/image001.jpg'}
    {'stopSignImages/image002.jpg'}
```

```
imageFileNames = fullfile(toolboxdir('vision'),'visiondata',imageFileNames);
dataSource = groundTruthDataSource(imageFileNames);
```

Define labels used to specify the ground truth. Use `labelDefinitionCreator` to create the label definitions table.

```
ldc = labelDefinitionCreator();
addLabel(ldc, 'stopSign', labelType.Rectangle);
addLabel(ldc, 'carRear', labelType.Rectangle);
labelDefs = create(ldc)
```

```
labelDefs=2x5 table
      Name          Type      LabelColor      Group      Description
      -----      -
      {'stopSign'}  Rectangle {0x0 char}  {'None'}   {' '}
      {'carRear'}  Rectangle {0x0 char}  {'None'}   {' '}
```

Initialize label data for rectangle ROIs.

```
stopSignTruth = {[856 318 39 41];[445 523 52 54]};
carRearTruth = {[398 378 315 210];[332 633 691 287]};
```

Construct a table of label data.

```
labelNames = {'stopSign'; 'carRear'};
labelData = table(stopSignTruth, carRearTruth, 'VariableNames', labelNames)
```

```
labelData=2x2 table
      stopSign          carRear
      -----      -
      {[856 318 39 41]}  {[398 378 315 210]}
      {[445 523 52 54]}  {[332 633 691 287]}
```

Create a ground truth object.

```
gTruth = groundTruth(dataSource, labelDefs, labelData)
```

```
gTruth =
  groundTruth with properties:
```

```
    DataSource: [1x1 groundTruthDataSource]
  LabelDefinitions: [2x5 table]
      LabelData: [2x2 table]
```

Create Ground Truth Data of Road Lanes

Create a `groundTruth` object to store data representing marked road lanes.

Create a data source from an image.

```
dataSource = groundTruthDataSource({'stopSignTest.jpg'});
```

Define labels used to specify ground truth. Use `labelDefinitionCreator` to create label definitions table.

```
ldc = labelDefinitionCreator();
addLabel(ldc, 'Lane', labelType.Line);
labelDefs = create(ldc);
```

Assign two lane markers in the image.

```
laneMarkerTruth = {[257 254;311 180] [327 183;338 205;374 250]};
```

Construct a table of label data.

```
labelNames = {'Lane'};
labelData = table(laneMarkerTruth, 'VariableNames', labelNames)
```

```
labelData=table
           Lane
_____
{2x2 double}  {3x2 double}
```

Create a `groundTruth` object.

```
gTruth = groundTruth(dataSource, labelDefs, labelData)
```

```
gTruth =
groundTruth with properties:
    DataSource: [1x1 groundTruthDataSource]
    LabelDefinitions: [1x5 table]
    LabelData: [1x1 table]
```

Create Ground Truth Data For Pixel Labels

Create a `groundTruth` object to store data representing parts of a scene.

Create a data source.

```
dataSource = groundTruthDataSource({'visionteam.jpg'});
```

Use `labelDefinitionCreator` to create the label definitions table. Define labels, 'Person' and 'Background'. Assign their corresponding label type as `PixelLabel`.

```
ldc =labelDefinitionCreator();
addLabel(ldc, 'Person', labelType.PixelLabel);
addLabel(ldc, 'Background', labelType.PixelLabel);
labelDefs = create(ldc)
```

```
labelDefs=2x6 table
           Name           Type           LabelColor           PixelLabelID           Group           Description
_____
{'Person'   }  PixelLabel  {0x0 char}           {[1]}                {'None'}           {' '}
```

```
{'Background'} PixelLabel {0x0 char} {[2]} {'None'} {' '}
```

Specify the location of the pixel label data for the image.

```
dataFile = {'visionteamPixelLabels.png'}
```

```
dataFile = 1x1 cell array
{'visionteamPixelLabels.png'}
```

Construct a table of label data for the pixel label data.

```
labelData = table(dataFile, 'VariableNames', {'PixelLabelData'})
```

```
labelData=table
PixelLabelData
-----
{'visionteamPixelLabels.png'}
```

Create a `groundTruth` object.

```
gTruth = groundTruth(dataSource, labelDefs, labelData)
```

```
gTruth =
groundTruth with properties:
    DataSource: [1x1 groundTruthDataSource]
    LabelDefinitions: [2x6 table]
    LabelData: [1x1 table]
```

Create Ground Truth for Car and Lane Markers

Create a data source from a video.

```
videoName = 'caltech_cordova1.avi';
dataSource = groundTruthDataSource(videoName);
```

Define labels used to specify the ground truth. Use a `labelDefinitionCreator` object to create the label definitions table.

```
ldc = labelDefinitionCreator();
addLabel(ldc, 'Cars', labelType.Rectangle);
addLabel(ldc, 'LaneMarkers', labelType.Line);
labelDefs = create(ldc)
```

```
labelDefs=2x5 table
Name Type LabelColor Group Description
-----
{'Cars'} Rectangle {0x0 char} {'None'} {' '}
{'LaneMarkers'} Line {0x0 char} {'None'} {' '}
```

Create label data for cars and lane markers.

```
numRows = numel(dataSource.TimeStamps);  
carsTruth = cell(numRows,1);  
laneMarkerTruth = cell(numRows,1);
```

Add two car labels and two lane markers to the first frame.

```
carsTruth{1} = [182 186 31 22;404 191 53 34];  
laneMarkerTruth{1} = {[257 254;311 180] [327 183;338 205;374 250]};
```

Create a table of label data.

```
labelNames = {'Cars', 'LaneMarkers'};  
labelData = table(carsTruth, laneMarkerTruth, 'VariableNames', labelNames);
```

Create a `groundTruth` object. To import this object into a labeling app, select an option from the **Open > Import Labels** menu.

```
gTruth = groundTruth(dataSource, labelDefs, labelData)
```

```
gTruth =  
    groundTruth with properties:
```

```
    DataSource: [1x1 groundTruthDataSource]  
    LabelDefinitions: [2x5 table]  
    LabelData: [250x2 timetable]
```

Tips

- `groundTruth` objects for video-based data sources rely on the video reading capabilities of your operating system. A `groundTruth` object created using a video data source remains consistent only for the same platform that was used to create it. To create a platform-independent `groundTruth` object, convert the video into a sequence of images and include the associated timestamps with the image sequence.

See Also

Apps

[Image Labeler](#) | [Video Labeler](#)

Functions

[pixelLabelTrainingData](#) | [objectDetectorTrainingData](#) | [pixelLabelDatastore](#) | [pixelLabelImageDatastore](#)

Objects

[labelDefinitionCreator](#) | [groundTruthDataSource](#) | [labelType](#) | [attributeType](#)

Topics

[“Get Started with the Image Labeler”](#)
[“Get Started with the Video Labeler”](#)
[“Use Custom Image Source Reader for Labeling”](#)
[“Share and Store Labeled Ground Truth Data”](#)

“How Labeler Apps Store Exported Pixel Labels”

Introduced in R2017a

selectLabels

Select ground truth data for a set of labels

Note The function will be removed in a future release. Use `selectLabelsByGroup`, `selectLabelsByType`, and `selectLabelsByName` instead.

For more information, see “`selectLabels` object function will be removed”

Syntax

```
gtLabel = selectLabels(gTruth, labelNames)
gtLabel = selectLabels(gTruth, types)
```

Description

`gtLabel = selectLabels(gTruth, labelNames)` returns a new `groundTruth` object, or array of `groundTruth` objects, containing only the labels specified by `labelNames`.

`gtLabel = selectLabels(gTruth, types)` returns a new `groundTruth` object, or array of `groundTruth` objects, containing only the label types specified by `types`.

Examples

Select Ground Truth Data By Label Name and Type

Add the image folder to the MATLAB path.

```
imageDir = fullfile(matlabroot, 'toolbox', 'vision', 'visiondata', 'stopSignImages');
addpath(imageDir);
```

Load the ground truth object.

```
load('stopSignsAndCarsGroundTruth.mat');
```

View the definitions.

```
stopSignsAndCarsGroundTruth.LabelDefinitions
```

```
ans=3x3 table
      Name      Type      Group
-----
{'stopSign'}  Rectangle {'None'}
{'carRear' }  Rectangle {'None'}
{'carFront'}  Rectangle {'None'}
```

Obtain the ground truth data for `labelName` 'stopSign'.

```
stopSignGroundTruth = selectLabels(stopSignsAndCarsGroundTruth, 'stopSign');
```

Obtain the ground truth data for `labelType` `Rectangle`.

```
rectGroundTruth = selectLabels(stopSignsAndCarsGroundTruth, labelType.Rectangle);
```

Obtain ground truth for 'carRear' and 'carFront'.

```
carGroundTruth = selectLabels(stopSignsAndCarsGroundTruth, {'carRear', 'carFront'});
```

Remove the image folder from the path.

```
rmpath(imageDir);
```

Input Arguments

gTruth — Ground truth labels

groundTruth object | array of groundTruth objects

Ground truth labels, specified as a `groundTruth` object or as an array of `groundTruth` objects.

labelNames — Label names

cell array of character vectors

Label names, specified as a cell array of character vectors.

types — Label type

`labelType` enumeration

Label type, specified as a `labelType` enumeration.

Output Arguments

gtLabel — Ground truth with only specified labels or types

groundTruth object | array of groundTruth objects

Ground truth with only specified labels or types, returned as a `groundTruth` object or as an array of `groundTruth` objects.

Compatibility Considerations

selectLabels object function will be removed

Not recommended starting in R2019a

The `selectLabels` function will be removed in a future release. Use `selectLabelsByName`, `selectLabelsByType`, and `selectLabelsByGroup` instead.

See Also

Functions

`groundTruth` | `groundTruthDataSource` | `selectLabelsByName` | `selectLabelsByGroup` | `selectLabelsByType`

Introduced in R2017a

vision.labeler.AutomationAlgorithm class

Package: vision.labeler

Interface for algorithm automation in ground truth labeling

Description

The `vision.labeler.AutomationAlgorithm` class specifies the interface for defining custom automation algorithms to run in the **Image Labeler**, **Video Labeler**, and **Ground Truth Labeler** apps. Classes that inherit from the `AutomationAlgorithm` interface can be used with the automation workflow of the labeling apps to generate ground truth labels.

The `vision.labeler.AutomationAlgorithm` class is a handle class.

Class Attributes

Abstract true

For information on class attributes, see “Class Attributes”.

Properties

The `AutomationAlgorithm` class predefines this set of properties.

GroundTruth — Ground truth data

`groundTruth` object | `groundTruthMultisignal` object

Ground truth data, specified as a `groundTruth` or `groundTruthMultisignal` object. This property holds all the labels in the labeling app prior to automation.

Attributes:

`GetAccess` public
`SetAccess` private

SelectedLabelDefinitions — Selected label definitions

structure

Label definitions selected for automation in the labeling app, specified as a structure. The labeling apps support selection of only one labeling definition per automation session. In the labeling apps, the selected label definition is highlighted in yellow in either the **ROI Labels** or **Scene Labels** pane on the left.

The structure contains these fields.

Field	Description
Type	labelType enumeration that contains the type of label definition. Valid label types are: labelType.Custom is not supported.
Name	Character vector that contains the name of the label definition.
Attributes (optional)	Structure array that contains one structure for each attribute in the label definition. If the label definition does not contain attributes, then this property does not include the Attributes field. The first field of each attribute structure in this structure array contains the attribute name. The second field contains a structure of values that are associated with that name. If you are defining a List attribute, you must also define the list of values for that attribute. Values for Numeric Value, String, or Logical attributes are optional. Descriptions for the attributes are optional for all cases.
PixelLabelID (optional)	Positive integer that contains the pixel label ID for the label definition. This PixelLabelID field applies only for label definitions of type PixelLabel.

To view a sample SelectedLabelDefinitions structure that contains an attribute, enter this code at the MATLAB command prompt.

```
selectedLabelDefs.Type = labelType.Rectangle;
selectedLabelDefs.Name = 'Car';
selectedLabelDefs.Attributes = struct('distance', ...
    struct('DefaultValue',0,'Description','Sensor distance'))
```

To view a sample SelectedLabelDefinitions structure that contains pixel label definitions, enter this code at the MATLAB command prompt.

```
selectedLabelDefs.Type = labelType.Rectangle;
selectedLabelDefs.Name = 'Car';
selectedLabelDefs.Attributes = struct('distance', ...
    struct('DefaultValue',0,'Description','Sensor distance'))
```

Attributes:

```
GetAccess           public
SetAccess           private
```

ValidLabelDefinitions — Valid label definitions

structure array

Valid label definitions that the algorithm can automate, specified as a structure array. Each structure in the array corresponds to a valid label definition. To determine which label definitions are valid, the app uses the checkLabelDefinition method. This table describes the fields for each valid label definition structure.

Field	Description
Type	LabelType enumeration that contains the type of label definition. Valid label types are: LabelType.Custom is not supported.
Name	Character vector that contains the name of the label definition.
Attributes (optional)	Structure array that contains one structure for each attribute in the label definition. If the label definition does not contain attributes, then this property does not include the Attributes field. The first field of each attribute structure in this structure array contains the attribute name. The second field contains a structure of values that are associated with that name. If you are defining a List attribute, you must also define the list of values for that attribute. Values for Numeric Value, String, or Logical attributes are optional. Descriptions for the attributes are optional for all cases.
PixelLabelID (optional)	Positive integer that contains the pixel label ID for the label definition. This PixelLabelID field applies only for label definitions of type PixelLabel.

To view a sample ValidLabelDefinitions structure that contains an attribute, enter this code at the MATLAB command prompt.

```
validLabelDefs(1).Type = labelType.Rectangle;
validLabelDefs(1).Name = 'Car';
validLabelDefs(2).Type = labelType.Line;
validLabelDefs(2).Name = 'LaneMarker';
validLabelDefs(3).Type = labelType.Scene;
validLabelDefs(3).Name = 'Sunny';
```

To view a sample ValidLabelDefinitions structure that contains pixel label definitions, enter this code at the MATLAB command prompt.

```
validLabelDefs(1).Type = labelType.PixelLabel;
validLabelDefs(1).Name = 'Road';
validLabelDefs(1).PixelLabelID = 1;
validLabelDefs(2).Type = labelType.PixelLabel;
validLabelDefs(2).Name = 'Sky';
validLabelDefs(2).PixelLabelID = 2
```

Attributes:

GetAccess	public
SetAccess	private

Clients of the AutomationAlgorithm class are required to define this set of properties. These properties set up the name, description, and user instructions for your automated algorithm.

Name — Automation algorithm name

character vector

Automation algorithm name, specified as a character vector.

Attributes:

GetAccess	public
Abstract	true
Constant	true
NonCopyable	true

Description — Automation algorithm description

character vector

Algorithm description, specified as a character vector.

Attributes:

GetAccess	public
Abstract	true
Constant	true
NonCopyable	true

UserDirections — Algorithm directions displayed in app

cell array

Algorithm directions displayed in app, specified as a cell array. `UserDirections` are specified as a `cellstr`, with each string representing a separate direction. Use the `checkSetup` method to verify that the directions have been adhered to.

Attributes:

GetAccess	public
Abstract	true
Constant	true
NonCopyable	true

Methods**Public Methods**

Clients of an `AutomationAlgorithm` implement these user-defined functions to define execution of the algorithm. For more information on creating your own automation algorithm, see “Create Automation Algorithm for Labeling”.

<code>checkLabelDefinition</code>	Validate label definition
<code>checkSignalType</code>	Validate signal type
<code>supportsMultisignalAutomation</code>	Set multisignal algorithm automation flag
<code>checkSetup</code>	Set up validation (optional)
<code>initialize</code>	Initialize state for algorithm execution (optional)
<code>run</code>	Run label automation on every frame in interval
<code>terminate</code>	Terminate automated algorithm (optional)
<code>settingsDialog</code>	Display algorithm settings (optional)

See Also**Apps**

Image Labeler | Ground Truth Labeler | Video Labeler

Functions

groundTruth | groundTruthMultisignal | labelType | vision.labeler.mixin.Temporal |
vision.labeler.mixin.BlockedImageAutomation

Topics

“Create Automation Algorithm for Labeling”

“Temporal Automation Algorithms”

“Blocked Image Automation Algorithms”

“Automate Ground Truth Labeling of Lane Boundaries” (Automated Driving Toolbox)

“Automate Ground Truth Labeling for Semantic Segmentation” (Automated Driving Toolbox)

“Automate Attributes of Labeled Objects” (Automated Driving Toolbox)

Introduced in R2017a

checkLabelDefinition

Class: vision.labeler.AutomationAlgorithm

Package: vision.labeler

Validate label definition

Syntax

```
isValid = checkLabelDefinition(algObj,labelDef)
```

Description

In the labeling apps, the `checkLabelDefinition` method checks whether each label defined in the **ROI Labels** and **Scene Labels** panes is valid. The method restricts an automation algorithm to use only relevant labels. For example, a label definition of type `Rectangle` cannot be used to mark a lane boundary.

Clients of `AutomationAlgorithm` must implement this method.

`isValid = checkLabelDefinition(algObj,labelDef)` returns `true` for valid label definitions and `false` for invalid definitions for the automation algorithm provided by `algObj`. `labelDef` is a structure containing all the label definitions in the **ROI Labels** and **Scene Labels** panes. Definitions that return `false` are disabled during automation.

Examples

Restrict Automation to Rectangular ROI Labels

This implementation of the `checkLabelDefinition` method designates `Rectangle` labels as valid and all other labels as invalid.

```
function isValid = checkLabelDefinition(algObj,labelDef)
    isValid = (labelDef.Type == labelType.Rectangle);
end
```

Restrict Automation to ROI Labels of Any Type

This implementation of the `checkLabelDefinition` method designates ROI labels such as `Rectangle` and `Line` as valid and all other labels as invalid.

```
function isValid = checkLabelDefinition(algObj,labelDef)
    isValid = isROI(labelDef.Type);
end
```

Input Arguments

algObj — Automation algorithm

vision.labeler.AutomationAlgorithm object

Automation algorithm, specified as a `vision.labeler.AutomationAlgorithm` object.

labelDef — Label definition

structure

Label definition, specified as a structure containing `Type` and `Name` fields.

Field	Description
Type	<p>labelType enumeration that contains the type of label definition. Valid label types are:</p> <ul style="list-style-type: none"> labelType.Rectangle labelType.Cuboid (for point clouds) labelType.ProjectiveCuboid (for image and video data) labelType.Line labelType.PixelLabel labelType.Scene <p>labelType.Custom is not supported.</p>
Name	Character vector that contains the name of the label definition.

To view a sample `labelDef` structure that contains a rectangle label definition, enter this code at the MATLAB command prompt.

```
labelDef(1).Type = labelType.Rectangle;
labelDef(1).Name = 'Car';
```

Output Arguments

isValid — True or false result of label definition validity check

1 | 0

True or false result of the label definition validity check, returned as a 1 or 0 of data type `logical`.

Tips

- To access the selected label definitions, use the `SelectedLabelDefinitions` property of the automation algorithm. In the labeling apps, the selected label definitions are highlighted in yellow in the **ROI Labels** and **Scene Labels** panes on the left.

See Also

`labelType` | `vision.labeler.AutomationAlgorithm` | `checkSignalType` | `checkSetup`

Introduced in R2017a

checkSetup

Class: vision.labeler.AutomationAlgorithm

Package: vision.labeler

Set up validation (optional)

Syntax

```
isReady = checkSetup(algObj)
isReady = checkSetup(algObj, labelsToAutomate)
```

Description

In the labeling apps, the `checkSetup` method checks the validity of the setup when you click **Run** in an automation session. If `checkSetup` returns `true`, then the setup is valid and the app proceeds to run the automation algorithm by using the `initialize`, `run`, and `terminate` methods.

Clients of `AutomationAlgorithm` can optionally implement this method.

`isReady = checkSetup(algObj)` returns `true` if you completed set up correctly and the automation algorithm `algObj` can begin execution. Otherwise, `checkSetup` returns `false`.

`isReady = checkSetup(algObj, labelsToAutomate)` additionally provides a table, `labelsToAutomate`, that contains labels selected for the automation algorithm to use for labeling. This syntax does not support pixel label automation. In addition, this syntax is available only for time-dependent (temporal) automation algorithms. The **Ground Truth Labeler** and **Video Labeler** apps support temporal algorithms but the **Image Labeler** does not. For more information on these types of algorithms, see “Temporal Automation Algorithms”.

Examples

Check Setup for ROI Labels

This implementation of the `checkSetup` method checks the setup for a temporal automation algorithm. This method determines that an automation algorithm is ready to run if at least one ROI label exists.

```
function isReady = checkSetup(algObj, labelsToAutomate)

    notEmpty = ~isempty(labelsToAutomate);
    hasROILabels = any(labelsToAutomate.Type == labelType.Rectangle);
    isReady = (notEmpty && hasROILabels)

end
```

Input Arguments

algObj — Automation algorithm

vision.labeler.AutomationAlgorithm object

Automation algorithm, specified as a `vision.labeler.AutomationAlgorithm` object.

LabelsToAutomate — Labels selected for automation

table

Labels selected for automation, specified as a table with these columns.

Column Name	Description
Type	<p>labelType enumeration that contains the type of the label. Valid label types are:</p> <ul style="list-style-type: none"> labelType.Rectangle labelType.Cuboid (Ground Truth Labeler app only) labelType.ProjectectedCuboid labelType.Line labelType.Scene <p>labelType.PixelLabel and labelType.Custom are not supported.</p>
Name	Character vector that contains the name of the label.
Time	Scalar of type double that specifies the time, in seconds, when the label was marked.

Column Name	Description						
Position	Location of the label in the frame. The format of this vector depends on the label type.						
	<table border="1"> <thead> <tr> <th data-bbox="508 390 711 426">Label Type</th> <th data-bbox="711 390 1481 426">Position Format</th> </tr> </thead> <tbody> <tr> <td data-bbox="508 426 711 720"> Rectangle — Rectangular region of interest (ROI) labels </td> <td data-bbox="711 426 1481 720"> M-by-4 numeric vector of the form $[x, y, w, h]$, where: <ul style="list-style-type: none"> • M is the number of labels in the frame. • x and y specify the upper-left corner of the rectangle. • w specifies the width of the rectangle, which is the length of the rectangle along the x-axis. • h specifies the height of the rectangle, which is the length of the rectangle along the y-axis. </td> </tr> <tr> <td data-bbox="508 720 711 1182"> Cuboid — Cuboid ROI labels </td> <td data-bbox="711 720 1481 1182"> M-by-9 numeric vector of the form $[xctr, yctr, zctr, xlen, ylen, zlen, xrot, yrot, zrot]$, where: <ul style="list-style-type: none"> • M is the number of labels in the frame. • xctr, yctr, and zctr specify the center of the cuboid. • xlen, ylen, and zlen specify the length of the cuboid along the x-axis, y-axis, and z-axis, respectively. • xrot, yrot, and zrot specify the rotation angles for the cuboid along the x-axis, y-axis, and z-axis, respectively. These angles are clockwise-positive when looking in the forward direction of their corresponding axes. <p>This figure shows how these values specify the position of a cuboid.</p> </td> </tr> </tbody> </table>	Label Type	Position Format	Rectangle — Rectangular region of interest (ROI) labels	M-by-4 numeric vector of the form $[x, y, w, h]$, where: <ul style="list-style-type: none"> • M is the number of labels in the frame. • x and y specify the upper-left corner of the rectangle. • w specifies the width of the rectangle, which is the length of the rectangle along the x-axis. • h specifies the height of the rectangle, which is the length of the rectangle along the y-axis. 	Cuboid — Cuboid ROI labels	M-by-9 numeric vector of the form $[xctr, yctr, zctr, xlen, ylen, zlen, xrot, yrot, zrot]$, where: <ul style="list-style-type: none"> • M is the number of labels in the frame. • xctr, yctr, and zctr specify the center of the cuboid. • xlen, ylen, and zlen specify the length of the cuboid along the x-axis, y-axis, and z-axis, respectively. • xrot, yrot, and zrot specify the rotation angles for the cuboid along the x-axis, y-axis, and z-axis, respectively. These angles are clockwise-positive when looking in the forward direction of their corresponding axes. <p>This figure shows how these values specify the position of a cuboid.</p>
	Label Type	Position Format					
Rectangle — Rectangular region of interest (ROI) labels	M-by-4 numeric vector of the form $[x, y, w, h]$, where: <ul style="list-style-type: none"> • M is the number of labels in the frame. • x and y specify the upper-left corner of the rectangle. • w specifies the width of the rectangle, which is the length of the rectangle along the x-axis. • h specifies the height of the rectangle, which is the length of the rectangle along the y-axis. 						
Cuboid — Cuboid ROI labels	M-by-9 numeric vector of the form $[xctr, yctr, zctr, xlen, ylen, zlen, xrot, yrot, zrot]$, where: <ul style="list-style-type: none"> • M is the number of labels in the frame. • xctr, yctr, and zctr specify the center of the cuboid. • xlen, ylen, and zlen specify the length of the cuboid along the x-axis, y-axis, and z-axis, respectively. • xrot, yrot, and zrot specify the rotation angles for the cuboid along the x-axis, y-axis, and z-axis, respectively. These angles are clockwise-positive when looking in the forward direction of their corresponding axes. <p>This figure shows how these values specify the position of a cuboid.</p>						

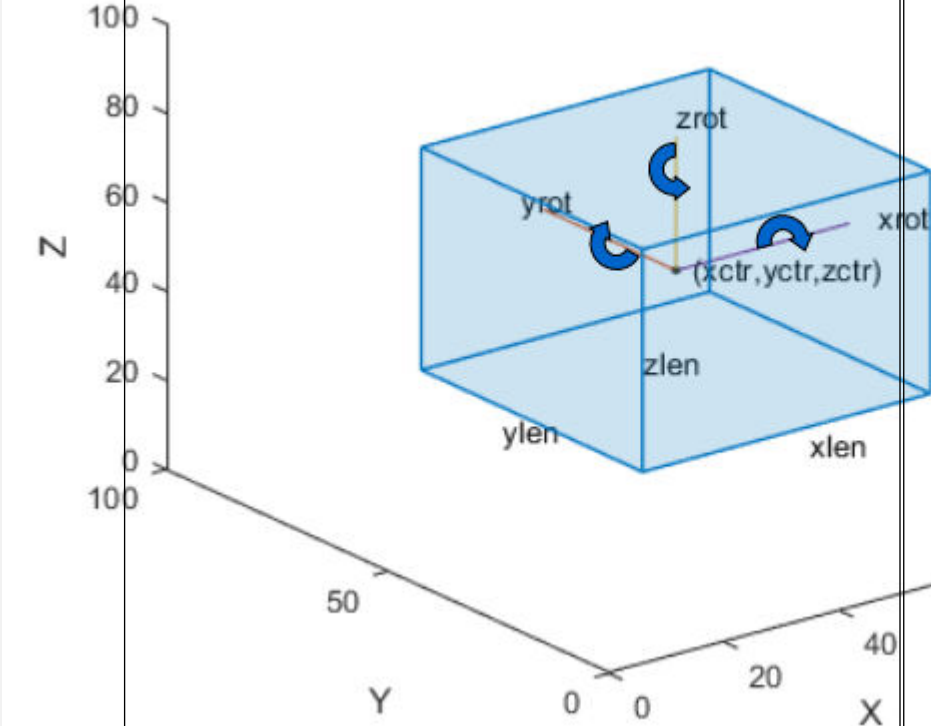
Column Name	Description	
	Label Type	Position Format
		
	ProjectedCuboid — Cuboid ROI labels	<p>M-by-8 vector of the form $[x1, y1, w1, h1, x2, y2, w2, h2]$, where:</p> <ul style="list-style-type: none"> • M is the number of labels in the frame. • $x1, y1$ specifies the x,y coordinates for the upper-left location of the front-face of the projected cuboid • $w1$ specifies the width for the front-face of the projected cuboid. • $h1$ specifies the height for the front-face of the projected cuboid. • $x2, y2$ specifies the x,y coordinates for the upper-left location of the back-face of the projected cuboid. • $w2$ specifies the width for the back-face of the projected cuboid. • $h2$ specifies the height for the back-face of the projected cuboid. <p>The figure shows how these values determine the position of a cuboid.</p>

Column Name	Description	
	Label Type	Position Format
	Line — Polyline ROI labels	M-by-1 vector of cell arrays, where M is the number of labels in the frame. Each cell array contains an N-by-2 numeric matrix of the form [x1 y1; x2 y2; ... ; xN yN] for N points in the polyline.
	Scene — Scene labels	Logical value of 1 if the label is present in the frame and 0 otherwise.

Each row of the table corresponds to a label selected for automation. This `labelsToAutomate` table contains a rectangle label, a line label with five points, and a cuboid label.

Type	Name	Time	Position
Rectangle	'Car'	0.033333	[1x4 double]
Line	'LaneMarker'	0.066667	[5x2 double]
Cuboid	'Truck'	0.099999	[1x9 double]

Output Arguments

isReady — True or false result of setup check

1 | 0

True or false result of the setup check, returned as a 1 or 0 of data type `logical`.

See Also

`labelType` | `vision.Labeler.AutomationAlgorithm` | `checkLabelDefinition` | `checkSignalType`

Introduced in R2017a

checkSignalType

Class: vision.labeler.AutomationAlgorithm

Package: vision.labeler

Validate signal type

Syntax

```
isValid = checkSignalType(signalType)
```

Description

In the labeling apps, the `checkSignalType` method validates whether each signal selected for automation supports the signal type relevant to the automation algorithm.

- Algorithms that automate the labeling of image collections, videos, or image sequences support signals of type `Image` only.
- Algorithms that automate the labeling of lidar point clouds support signals of type `PointCloud` only.

The implementation of this method depends on which labeling app the automation algorithm is being used with.

Labeling App of Automation Algorithm	checkSignalType Implementation
Image Labeler Video Labeler	You do not need to implement this method. By default, this method validates that the signal being automated is of type <code>Image</code> , which is the only signal type that these apps support.
Ground Truth Labeler	Update this method to validate whether the automation algorithm supports <code>Image</code> signals, <code>PointCloud</code> signals, or both types of signals.
Lidar Labeler	You do not need to implement this method. If you do implement this method, update it to validate that the signal is of type <code>PointCloud</code> , which is the only signal type that this app supports.

`isValid = checkSignalType(signalType)` returns logical 1 (true) when the specified signal type is valid. In the **Ground Truth Labeling** app, if you select an automation algorithm, select signals that are of an invalid type, and then click **Automate**, the app displays an error.

Examples

Restrict Automation to Image Signals

Implement the `checkSignalType` method to designate `Image` signals as valid and all other signals as invalid.

```
function isValid = checkSignalType(signalType)
    isValid = (signalType == vision.labeler.loading.SignalType.Image);
end
```

Restrict Automation to Point Cloud Signals

Implement the `checkSignalType` method to designate `PointCloud` signals as valid and all other signals as invalid.

```
function isValid = checkSignalType(signalType)
    isValid = (signalType == vision.labeler.loading.SignalType.PointCloud);
end
```

Enable Automation for Image and Point Cloud Signals

Implement the `checkSignalType` method to designate `Image` and `PointCloud` signals as valid.

```
function isValid = checkSignalType(signalType)
    isValid = any(signalType == vision.labeler.loading.SignalType.Image) && ...
        any(signalType == vision.labeler.loading.SignalType.PointCloud);
end
```

Input Arguments

signalType — Signal type

`vision.labeler.loading.SignalType` enumeration

Signal type, specified as a `vision.labeler.loading.SignalType` enumeration.

Example: `vision.labeler.loading.SignalType.Image`

Example: `vision.labeler.loading.SignalType.PointCloud`

Output Arguments

isValid — Result of signal type validity check

1 | 0

Result of the signal type validity check, returned as logical 1 (true) or logical 0 (false).

Attributes

Static true

To learn about attributes of methods, see [Method Attributes](#).

See Also

`vision.labeler.loading.SignalType` | `checkLabelDefinition` | `vision.labeler.AutomationAlgorithm` | `checkSetup`

Introduced in R2020a

initialize

Class: `vision.labeler.AutomationAlgorithm`

Package: `vision.labeler`

Initialize state for algorithm execution (optional)

Syntax

```
initialize(algObj, frame)
initialize(algObj, frame, labelsToAutomate)
```

Description

The `initialize` method initializes the state of the automation algorithm before the automation algorithm runs.

Clients of `AutomationAlgorithm` can optionally implement this method.

`initialize(algObj, frame)` initializes the state of the `algObj` automation algorithm using the first frame in the time range of the data being labeled.

Clients of `AutomationAlgorithm` must implement this user-defined method.

`initialize(algObj, frame, labelsToAutomate)` additionally provides a table, `labelsToAutomate`, that contains labels selected for the automation algorithm to use for labeling. This syntax does not support pixel label automation. In addition, this syntax is available only for time-dependent (temporal) automation algorithms. The **Ground Truth Labeler** (requires Automated Driving Toolbox™) and **Video Labeler** apps support temporal algorithms but the **Image Labeler** does not. For more information on these types of algorithms, see “Temporal Automation Algorithms”.

Input Arguments

algObj — Automation algorithm

`vision.labeler.AutomationAlgorithm` object

Automation algorithm, specified as a `vision.labeler.AutomationAlgorithm` object.

frame — Frame corresponding to start of time range

numeric matrix | `pointCloud` object

Frame corresponding to the start of time range, specified as a numeric matrix for Image signals or a `pointCloud` object for `PointCloud` signals.

labelsToAutomate — Labels selected for automation

table

Labels selected for automation, specified as a table with these columns.

Column Name	Description
Type	labelType enumeration that contains the type of the label. Valid label types are: <ul style="list-style-type: none">• labelType.Rectangle• labelType.Cuboid (Ground Truth Labeler app only)• labelType.ProjectectedCuboid• labelType.Line• labelType.Scene labelType.PixelLabel and labelType.Custom are not supported.
Name	Character vector that contains the name of the label.
Time	Scalar of type double that specifies the time, in seconds, when the label was marked.

Column Name	Description						
Position	Location of the label in the frame. The format of this vector depends on the label type.						
	<table border="1"> <thead> <tr> <th data-bbox="508 390 711 426">Label Type</th> <th data-bbox="711 390 1481 426">Position Format</th> </tr> </thead> <tbody> <tr> <td data-bbox="508 426 711 720">Rectangle — Rectangular region of interest (ROI) labels</td> <td data-bbox="711 426 1481 720"> M-by-4 numeric vector of the form $[x, y, w, h]$, where: <ul style="list-style-type: none"> • M is the number of labels in the frame. • x and y specify the upper-left corner of the rectangle. • w specifies the width of the rectangle, which is the length of the rectangle along the x-axis. • h specifies the height of the rectangle, which is the length of the rectangle along the y-axis. </td> </tr> <tr> <td data-bbox="508 720 711 1182">Cuboid — Cuboid ROI labels</td> <td data-bbox="711 720 1481 1182"> M-by-9 numeric vector of the form $[xctr, yctr, zctr, xlen, ylen, zlen, xrot, yrot, zrot]$, where: <ul style="list-style-type: none"> • M is the number of labels in the frame. • xctr, yctr, and zctr specify the center of the cuboid. • xlen, ylen, and zlen specify the length of the cuboid along the x-axis, y-axis, and z-axis, respectively. • xrot, yrot, and zrot specify the rotation angles for the cuboid along the x-axis, y-axis, and z-axis, respectively. These angles are clockwise-positive when looking in the forward direction of their corresponding axes. <p>This figure shows how these values specify the position of a cuboid.</p> </td> </tr> </tbody> </table>	Label Type	Position Format	Rectangle — Rectangular region of interest (ROI) labels	M-by-4 numeric vector of the form $[x, y, w, h]$, where: <ul style="list-style-type: none"> • M is the number of labels in the frame. • x and y specify the upper-left corner of the rectangle. • w specifies the width of the rectangle, which is the length of the rectangle along the x-axis. • h specifies the height of the rectangle, which is the length of the rectangle along the y-axis. 	Cuboid — Cuboid ROI labels	M-by-9 numeric vector of the form $[xctr, yctr, zctr, xlen, ylen, zlen, xrot, yrot, zrot]$, where: <ul style="list-style-type: none"> • M is the number of labels in the frame. • xctr, yctr, and zctr specify the center of the cuboid. • xlen, ylen, and zlen specify the length of the cuboid along the x-axis, y-axis, and z-axis, respectively. • xrot, yrot, and zrot specify the rotation angles for the cuboid along the x-axis, y-axis, and z-axis, respectively. These angles are clockwise-positive when looking in the forward direction of their corresponding axes. <p>This figure shows how these values specify the position of a cuboid.</p>
	Label Type	Position Format					
Rectangle — Rectangular region of interest (ROI) labels	M-by-4 numeric vector of the form $[x, y, w, h]$, where: <ul style="list-style-type: none"> • M is the number of labels in the frame. • x and y specify the upper-left corner of the rectangle. • w specifies the width of the rectangle, which is the length of the rectangle along the x-axis. • h specifies the height of the rectangle, which is the length of the rectangle along the y-axis. 						
Cuboid — Cuboid ROI labels	M-by-9 numeric vector of the form $[xctr, yctr, zctr, xlen, ylen, zlen, xrot, yrot, zrot]$, where: <ul style="list-style-type: none"> • M is the number of labels in the frame. • xctr, yctr, and zctr specify the center of the cuboid. • xlen, ylen, and zlen specify the length of the cuboid along the x-axis, y-axis, and z-axis, respectively. • xrot, yrot, and zrot specify the rotation angles for the cuboid along the x-axis, y-axis, and z-axis, respectively. These angles are clockwise-positive when looking in the forward direction of their corresponding axes. <p>This figure shows how these values specify the position of a cuboid.</p>						

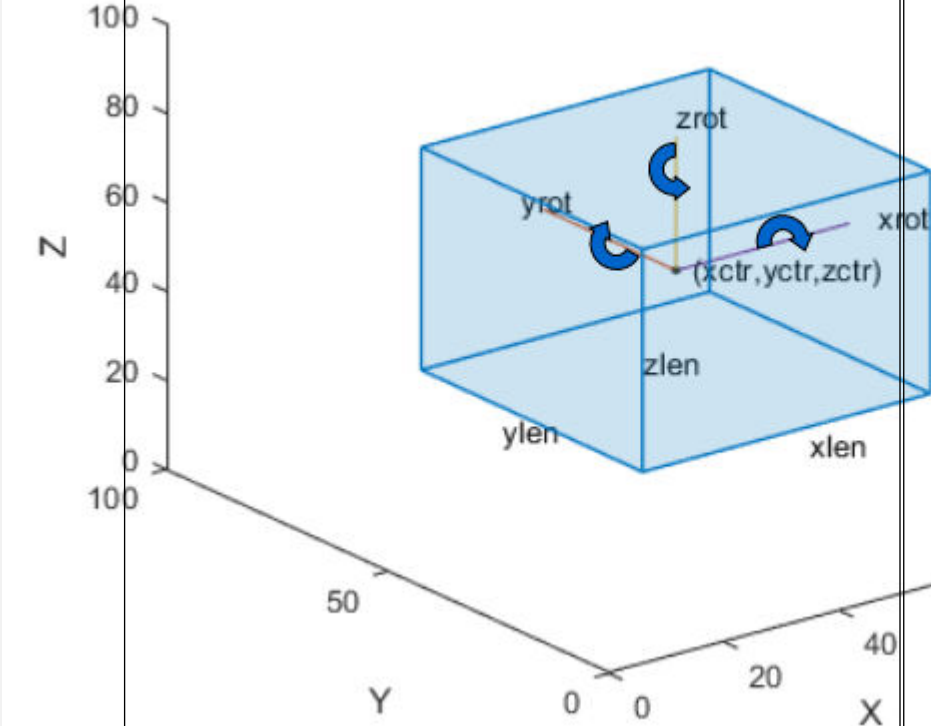
Column Name	Description	
	Label Type	Position Format
		
ProjectedCuboid – Cuboid ROI labels		<p>M-by-8 vector of the form $[x1, y1, w1, h1, x2, y2, w2, h2]$, where:</p> <ul style="list-style-type: none"> • M is the number of labels in the frame. • $x1, y1$ specifies the x,y coordinates for the upper-left location of the front-face of the projected cuboid • $w1$ specifies the width for the front-face of the projected cuboid. • $h1$ specifies the height for the front-face of the projected cuboid. • $x2, y2$ specifies the x,y coordinates for the upper-left location of the back-face of the projected cuboid. • $w2$ specifies the width for the back-face of the projected cuboid. • $h2$ specifies the height for the back-face of the projected cuboid. <p>The figure shows how these values determine the position of a cuboid.</p>

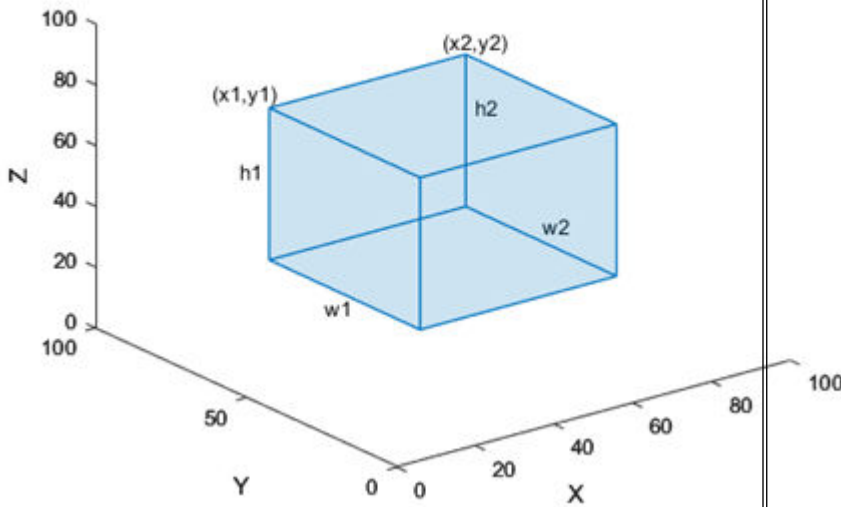
Column Name	Description	
	Label Type	Position Format
		
	Line — Polyline ROI labels	M-by-1 vector of cell arrays, where M is the number of labels in the frame. Each cell array contains an N-by-2 numeric matrix of the form [x1 y1; x2 y2; ... ; xN yN] for N points in the polyline.
	Scene — Scene labels	Logical value of 1 if the label is present in the frame and 0 otherwise.

Each row of the table corresponds to a label selected for automation. This `labelsToAutomate` table contains a rectangle label, a line label with five points, and a cuboid label.

Type	Name	Time	Position
Rectangle	'Car'	0.033333	[1x4 double]
Line	'LaneMarker'	0.066667	[5x2 double]
Cuboid	'Truck'	0.099999	[1x9 double]

See Also

`checkSetup` | `run` | `terminate` | `labelType` | `vision.labeler.AutomationAlgorithm`

Introduced in R2017a

run

Class: `vision.labeler.AutomationAlgorithm`

Package: `vision.labeler`

Run label automation on every frame in interval

Syntax

```
autoLabels = run(algObj, frame)
```

Description

The `run` method computes the automated labels for a single frame by executing the automation algorithm. During automation, the labeling apps run this method in a loop to compute the automated labels for each frame in the selection being automated.

Clients of `AutomationAlgorithm` must implement this method.

`autoLabels = run(algObj, frame)` processes a single frame, `frame`, using the `algObj` automation algorithm, and returns the automated labels, `autoLabels`.

Input Arguments

algObj — Automation algorithm

`vision.labeler.AutomationAlgorithm` object

Automation algorithm, specified as a `vision.labeler.AutomationAlgorithm` object.

frame — Frame

numeric matrix

Frame whose labels are being computed, specified as a numeric matrix for `Image` signals or a `pointCloud` object for `PointCloud` signals.

Output Arguments

autoLabels — Labels produced by automation

categorical matrix | structure array | table

Labels produced by the automation algorithm, returned as a categorical matrix, structure array, or table.

For algorithms that automate pixel labeling, implement the `run` method to return `autoLabels` as a categorical label matrix, where each category represents a pixel label. For more information, see “How Labeler Apps Store Exported Pixel Labels”.

For algorithms that automate nonpixel labels, implement the `run` method to return a structure array. Each structure in the array contains the labels of a specific name and type. The method combines labels of the same name and type into a single structure in the array.

This table describes the columns of the autoLabels table or fields of each autoLabels structure.

Field Name	Description
Type	labelType enumeration that contains the type of the label. Valid label types are: <ul style="list-style-type: none">• labelType.Rectangle• labelType.Cuboid (Ground Truth Labeler app only)• labelType.ProjectectedCuboid• labelType.Line• labelType.Scene
Name	Character vector containing the name of the label.

Field Name	Description	
Position	Position of labels of the specified Name and Type. The format of Position depends on the label type.	
	Label Type	Position Format
	Rectangle — Rectangular region of interest (ROI) labels	<p>M-by-4 numeric matrix of the form [x, y, w, h], where:</p> <ul style="list-style-type: none"> • M is the number of labels in the frame. • x and y specify the upper-left corner of the rectangle. • w specifies the width of the rectangle, which is its length along the x-axis. • h specifies the height of the rectangle, which is its length along the y-axis.
Cuboid — Cuboid ROI labels	<p>M-by-9 numeric matrix with rows of the form [xctr, yctr, zctr, xlen, ylen, zlen, xrot, yrot, zrot], where:</p> <ul style="list-style-type: none"> • M is the number of labels in the frame. • xctr, yctr, and zctr specify the center of the cuboid. • xlen, ylen, and zlen specify the length of the cuboid along the x-axis, y-axis, and z-axis, respectively, before rotation has been applied. • xrot, yrot, and zrot specify the rotation angles for the cuboid along the x-axis, y-axis, and z-axis, respectively. These angles are clockwise-positive when looking in the forward direction of their corresponding axes. <p>The figure shows how these values determine the position of a cuboid.</p>	

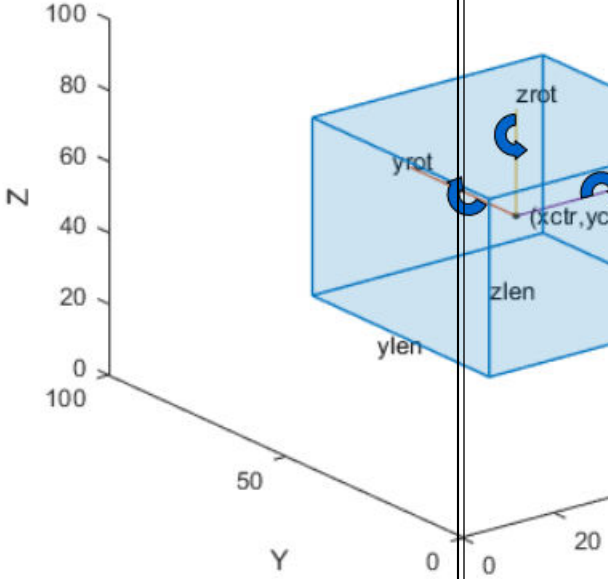
Field Name	Description	
	Label Type	Position Format
		
	<p>ProjectedCuboid — Cuboid ROI labels</p>	<p>M-by-8 vector of the form [x1, y1, w1, h1, x2, y2, w2, h2], where:</p> <ul style="list-style-type: none"> • M is the number of labels in the frame. • x1, y1 specifies the x,y coordinates for the upper-left location of the front-face of the projected cuboid • w1 specifies the width for the front-face of the projected cuboid. • h1 specifies the height for the front-face of the projected cuboid. • x2, y2 specifies the x,y coordinates for the upper-left location of the back-face of the projected cuboid. • w2 specifies the width for the back-face of the projected cuboid. • h2 specifies the height for the back-face of the projected cuboid. <p>The figure shows how these values determine the position of a cuboid.</p>

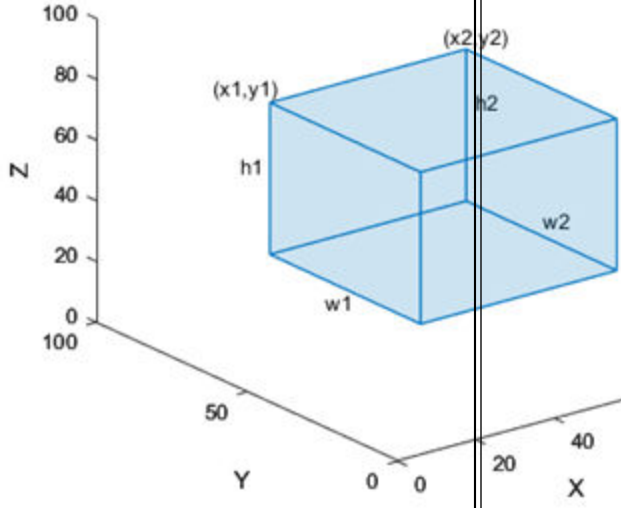
Field Name	Description	
	Label Type	Position Format
		
	Line — Polyline ROI labels	M-by-1 vector of cell arrays, where M is the number of labels in the frame. Each cell array contains an N-by-2 numeric matrix of the form [x1 y1; x2 y2; ... ; xN yN] for N points in the polyline.
	Scene — Scene labels	Logical value of 1 if the algorithm determines that the label is present in the frame and 0 otherwise.
Attributes (optional)	<p>Structure array that contains one structure for each attribute in the label. If the label definition does not contain attributes, then the <code>autoLabels</code> output does not include this field.</p> <p>For each structure in the <code>Attributes</code> structure array, the name of that structure is the name of the corresponding attribute. The value of the structure is the value of the corresponding attribute.</p>	

To view a sample `autoLabels` structure array, enter this code at the MATLAB command prompt.

```

autoLabels(1).Name      = 'Car';
autoLabels(1).Type     = labelType.Rectangle;
autoLabels(1).Position = [20 20 50 50];

autoLabels(2).Name     = 'Truck';
autoLabels(2).Type     = labelType.Rectangle;
autoLabels(2).Position = [70 70 50 50];

```

Alternatively, for nonpixel labels, you can use the `run` method to return `autoLabels` as a table. The table rows are equivalent to the structures in a structure array. The table columns are equivalent to

the structure fields. This table is equivalent to the sample `autoLabels` structure array previously specified.

<u>Name</u>	<u>Type</u>	<u>Position</u>
'Car'	Rectangle	[1x4 double]
'Truck'	Rectangle	[1x4 double]

See Also

`checkSetup` | `initialize` | `terminate` | `labelType` |
`vision.labeler.AutomationAlgorithm`

Introduced in R2017a

settingsDialog

Class: `vision.labeler.AutomationAlgorithm`

Package: `vision.labeler`

Display algorithm settings (optional)

Syntax

```
settingsDialog(algObj)
```

Description

The `settingsDialog` method runs when the user clicks Settings in the labeling app. Use this method to provide a dialog figure with controls for user settings required for the algorithm. Use a modal dialog, created using functions like `dialog`, `inputdlg` or `listdlg`.

Clients of `AutomationAlgorithm` can optionally implement this method.

`settingsDialog(algObj)` displays automated algorithm settings in a dialog.

Input Arguments

algObj — Automation algorithm

`vision.labeler.AutomationAlgorithm` object

Automation algorithm, specified as a `vision.labeler.AutomationAlgorithm` object.

Introduced in R2017a

supportsMultisignalAutomation

Package: vision.labeler

Set multisignal algorithm automation flag

Syntax

```
success = supportsMultisignalAutomation(algObj)
```

Description

`success = supportsMultisignalAutomation(algObj)` indicates whether the automation algorithm `algObj` supports the automation of multiple signals in a single automation session. Implement this method in automation algorithms developed for the **Ground Truth Labeler** app, which supports the labeling and automation of multiple signals. If the algorithm supports multisignal automation, then this method returns `success` as `true`.

In automation algorithms developed for the **Image Labeler**, **Video Labeler**, and **Lidar Labeler** apps, which support the labeling and automation of only one signal at a time, you can either delete this method or leave it unchanged. The default implementation of this method indicates that the automation algorithm does not support multisignal automation (`success = false`).

Examples

Indicate Algorithm Supports Multisignal Automation

Implement the `supportsMultisignalAutomation` method to indicate that the automation algorithm supports multisignal automation. This method is static and does not use the input automation algorithm, `algObj`. Therefore, you can specify the input argument as unused by using the tilde (~) operator.

```
function success = supportsMultisignalAutomation(~)
    success = true;
end
```

Input Arguments

`algObj` — Automation algorithm

`vision.labeler.AutomationAlgorithm` object

Automation algorithm, specified as a `vision.labeler.AutomationAlgorithm` object.

See Also

Apps

Ground Truth Labeler

Objects

`vision.labeler.AutomationAlgorithm`

Introduced in R2021a

terminate

Class: `vision.labeler.AutomationAlgorithm`

Package: `vision.labeler`

Terminate automated algorithm (optional)

Syntax

```
terminate(algObj)
```

Description

The `terminate` method cleans up the state of the automation algorithm after `run` processes the last frame in the specified interval or when you stop the automation algorithm.

Clients of `AutomationAlgorithm` can optionally implement this method.

`terminate(algObj)` cleans up the state of the automation algorithm.

Input Arguments

algObj — Automation algorithm

`vision.labeler.AutomationAlgorithm` object

Automation algorithm, specified as a `vision.labeler.AutomationAlgorithm` object.

See Also

`checkSetup` | `initialize` | `run` | `vision.labeler.AutomationAlgorithm`

Introduced in R2017a

vision.labeler.mixin.Temporal class

Package: vision.labeler.mixin

Mixin interface for adding temporal context to automation algorithms

Description

The `vision.labeler.mixin.Temporal` class provides an interface for attaching temporal properties to an automation algorithm. You can add this class only to automation algorithms used by the **Ground Truth Labeler** or **Video Labeler** app.

The `vision.labeler.mixin.Temporal` class is a `handle` class.

Class Attributes

Abstract true

For information on class attributes, see “Class Attributes”.

Properties

StartTime — Timestamp of first frame

scalar

Timestamp of the first frame of the algorithm interval, specified as a scalar.

Attributes:

GetAccess	public
SetAccess	private
Dependent	true
NonCopyable	true

CurrentTime — Timestamp of current executing frame

scalar

Timestamp of the current executing frame, specified as a scalar. This value updates during the execution of the algorithm.

Attributes:

GetAccess	public
SetAccess	private

EndTime — Timestamp of last frame

scalar

Timestamp of the last frame of the algorithm interval, specified as a scalar.

Attributes:

GetAccess	public
SetAccess	private
Dependent	true
NonCopyable	true

StartFrameIndex — Index of first frame

integer

Index of the first frame of the algorithm interval, specified as an integer.

Attributes:

GetAccess	public
SetAccess	private
Dependent	true
NonCopyable	true

EndFrameIndex — Index of last frame

integer

Index of the last frame of the algorithm interval, specified as an integer.

Attributes:

GetAccess	public
SetAccess	private
Dependent	true
NonCopyable	true

AutomationDirection — Direction in which to run automated algorithm

'Forward' | 'Reverse'

Direction in which to run the automated algorithm, specified as 'Forward' or 'Reverse'.

Attributes:

GetAccess	public
SetAccess	private

Methods**Public Methods**

supportsReverseAutomation Set reverse algorithm automation flag

See Also**Apps**

Ground Truth Labeler | Video Labeler

Objects

vision.labeler.AutomationAlgorithm

Topics

“Create Automation Algorithm for Labeling”

“Temporal Automation Algorithms”

Introduced in R2017b

supportsReverseAutomation

Set reverse algorithm automation flag

Syntax

```
flag = supportsReverseAutomation(algObj)
```

Description

`flag = supportsReverseAutomation(algObj)` indicates whether the temporal automation algorithm, `algObj`, supports automation in the reverse direction. A `true` value enables the **Ground Truth Labeler** or **Video Labeler** to open the algorithm in reverse mode.

Examples

Set Algorithm Automation Direction Flag

```
function flag = supportsReverseAutomation(algObj)
    flag = true;
end
```

Input Arguments

algObj — Temporal automation algorithm
object

Temporal automation algorithm, specified as an object.

Output Arguments

flag — Reverse automation indicator
`true` | `false`

Reverse automation indicator, returned as `true` or `false`.

See Also

Apps
Ground Truth Labeler | **Video Labeler**

Objects
`vision.labeler.mixin.Temporal`

Introduced in R2017b

vision.labeler.mixin.BlockedImageAutomation

Mixin interface for performing blocked image automation

Description

The `BlockedImageAutomation` mixin class provides an interface for attaching blocked image properties to an automation algorithm. You can add this class only to automation algorithms used by the **Image Labeler** app.

Creation

Description

To use the `vision.labeler.mixin.BlockedImageAutomation` object, open the **Image Labeler** app, load a blocked image, and create at least one label. Then, click **Select Algorithm** in the **Automate Labeling** section of the app toolstrip. Select **Add Blocked Image Algorithm** and then choose **Create New Blocked Image Algorithm**. A class template opens in the editor that inherits from both the `vision.labeler.AutomationAlgorithm` class and the `vision.labeler.mixin.BlockedImageAutomation` mixin class. Edit this template to create your blocked image automation algorithm.

Properties

The `BlockedImageAutomation` mixin class predefines this set of properties.

BatchSize — Number of blocks supplied to the apply function at a time

numeric scalar

Number of blocks supplied to the apply function at a time, specified as an integer valued vector of length equal to the `NumDimensions` property of the blocked image.

BorderSize — Size of additional border elements

1-by- D numeric vector

Size of additional border elements to add around a block in each dimension, specified as a 1-by- D numeric vector, where D is equal to the `NumDimensions` property of the first blocked image object.

InclusionThreshold — Ratio that determines whether a block should be considered for processing

double

Ratio that determines whether a block should be considered for processing, specified as a value in the range [0 1]. The value specifies the minimum percentage of nonzero pixels in the block. A value of 0 means that only one pixel in the block must be true/nonzero for it to be included in processing. A value of 1 requires that all pixels in the block be true/nonzero for it to be included in processing.

PadMethod — Method used to obtain padding pixels

scalar string | char vector

Method used to obtain padding pixels to honor the `BorderSize` or the `PadPartialBlocks` parameters, specified as scalar string or char vector

PadPartialBlocks — Pad partial blocks that might exist on the edges

true | false

Pad partial blocks that might exist on the edges, specified as a logical scalar, true or false.

Resume — Continue processing from where a previous run stopped

true | false

Continue processing from where a previous run stopped, specified as a logical scalar, true or false.

Object Functions

`blockedImageAutomationAlgorithm` Implements the blocked image automation algorithm

See Also

Apps

Image Labeler

Objects

`vision.labeler.AutomationAlgorithm`

Topics

“Create Automation Algorithm for Labeling”

“Temporal Automation Algorithms”

Introduced in R2021a

blockedImageAutomationAlgorithm

Implements the blocked image automation algorithm

Syntax

```
res = blockedImageAutomationAlgorithm(algObj,bstruct)
```

Description

`res = blockedImageAutomationAlgorithm(algObj,bstruct)` computes labels based on the algorithm you specify in this method. The **Image Labeler** app invokes this method on each image you choose for blocked image automation in the app. `algObj` is a `vision.labeler.AutomationAlgorithm` object. `bstruct` is a structure. The format of the output, `res`, depends on the type of automation algorithm specified.

Examples

Sample Blocked Image Algorithm Automation Function

- Here is an example of a blocked image algorithm automation function.

```
function res = blockedImageAutomationAlgorithm(algObj,bstruct)
    % Detect people using aggregate channel features
    detector = peopleDetectorACF('inria-100x41');
    [bboxes, scores] = detect(detector, bstruct.Data,...
        'SelectStrongest', false);

    % Apply non-maximum suppression to select the strongest bounding boxes.
    [selectedBboxes, selectedScores] = selectStrongestBbox(bboxes, scores,...
        'RatioType', 'Min',...
        'OverlapThreshold', 0.65);

    % Consider only detections that meet specified score threshold
    selectedBboxes = selectedBboxes(selectedScores > 0, :);
    selectedBboxes(:,1) = selectedBboxes(:,1)+bstruct.Start(2);
    selectedBboxes(:,2) = selectedBboxes(:,2)+bstruct.Start(1);

    if algObj.SelectedLabelDefinitions.Type == "Rectangle"
        % Add the selected label at the bounding box position(s)
        res = struct(...
            'Type', labelType.Rectangle,...
            'Name', algObj.SelectedLabelDefinitions.Name,...
            'Position', selectedBboxes);
    end
end
```

Input Arguments

`algObj` — Automation algorithm

`vision.labeler.AutomationAlgorithm` object

Automation algorithm, specified as a `vision.labeler.AutomationAlgorithm` object.

struct — Structure of data passed to function

scalar struct

Structure of data passed to the blocked image apply object function, specified as a scalar struct with these fields.

Field	Description
Data	A block of array data from the blocked image.
Start	Array subscripts of the first element in the block. If <code>BorderSize</code> is specified, this subscript can be out-of-bounds for edge blocks.
End	Array subscripts of the last element in the block. If <code>BorderSize</code> is specified, this subscript can be out-of-bounds for edge blocks.
Blocksub	The block subscripts of the current block
BorderSize	The value of the <code>BorderSize</code> parameter
BlockSize	The value of the <code>BlockSize</code> parameter. Note: <code>size(data)</code> can be less than this value for border blocks <code>PadPartialValue</code> is false.
BatchSize	The value of the <code>BatchSize</code> parameter

Output Arguments

res — Result of processing

scalar struct

Result of processing, returned as a scalar struct. The format of the structure depends on the type of automation algorithm.

For automation algorithms without pixel labels, the struct has fields described in this table.

Field	Description
Type	A <code>labelType</code> enumeration that defines the type of label. Type can have values: <code>Rectangle</code> , <code>Line</code> , <code>Projected_cuboid</code> , <code>Cuboid</code> , or <code>Scene</code> .
Name	A character vector specifying a label name that returns <code>true</code> for <code>checkLabelDefinition</code> . Only existing label names previously defined in the Image Labeler app can be used.

Field	Description	
Position	Positions of the labels. The type of label determines the format of the position data.	
	Label Type	Description
	Rectangle	P -by-1 cell array specifying P Rectangles, each containing a 1-by-4 vector specifying position of the bounding box locations as $[x\ y\ w\ h]$ or multiple Rectangle ROIs specified as an M -by-4 matrix.
	Line	P -by-1 cell array specifying P polylines each containing N -by-2 vector specifying N points along each polyline as: $[x_1, y_1; x_2, y_2; \dots x_N, y_N]$
	Polygons	P -by-1 cell array specifying P polygons each containing N -by-2 vector specifying N points along each polygon as: $[x_1, y_1; x_2, y_2; \dots x_N, y_N]$
Projected Cuboid	P -by-1 cell array specifying P projected cuboids each containing 1-by-8 vector specifying position of primary and secondary faces as: $[x_1\ y_1\ w_1\ h_1\ x_2\ y_2\ w_2\ h_2]$ or multiple projected cuboid ROIs can be specified as an M -by-8 matrix.	
Attributes	An array of <code>structs</code> representing the attributes contained by the automated labels. Each attribute is specified as a field of the <code>struct</code> with the name of the field representing the name of the attribute and the value of the field representing the value of the attribute. This is an optional field, only present if the labels defined have attributes.	

For automation algorithms with pixel labels, `res` is a categorical label matrix, where each category represents a pixel label.

Tips

- For automation algorithms without pixel labels, the `Position` field in `res` must be in a world coordinate system. This can be achieved by adding the X and Y indices in the `bstruct.Start` field to the output of the automation algorithm. To get the correct X coordinate, add `bstruct.Start(2)` to get the position of the automation output in world coordinates. To get the correct Y coordinate, add `bstruct.Start(1)` to get the position of the automation output in world coordinates.

See Also

Apps
Image Labeler

Objects

vision.labeler.mixin.Temporal

Introduced in R2021a

labelType

Label type enumerations for labeling

Description

The `labelType` enumerations enable you to specify the types of labels used in these labeling apps: **Image Labeler**, **Video Labeler**, **Lidar Labeler**, and **Ground Truth Labeler**. When creating label definitions by using a `labelDefinitionCreator` or `labelDefinitionCreatorMultisignal` object, use these enumerations to create label definitions of specific types. When selecting labels from a `groundTruth` or `groundTruthMultisignal` or `groundTruthLidar` (Lidar Toolbox) object, use these enumerations to select labels of a specific type.

Creation

Syntax

```
labelType('Rectangle')  
labelType('Line')  
labelType('PixelLabel')  
labelType('Polygon')  
labelType('Cuboid')  
labelType('ProjectedCuboid')  
labelType('Scene')  
labelType('Custom')
```

Description

`labelType('Rectangle')` creates a rectangular region of interest (ROI) label type for labeling image and video data. You can also use the programmatic format, `labelType.Rectangle`.

`labelType('Line')` creates a polyline ROI label type for labeling image and video data. You can also use the programmatic format, `labelType.Line`.

`labelType('PixelLabel')` creates a pixel ROI label type for labeling image and video data. You can also use the programmatic format, `labelType.PixelLabel`.

`labelType('Polygon')` creates a polygon ROI label type for labeling image and video data. You can also use the programmatic format, `labelType.Polygon`.

`labelType('Cuboid')` creates a cuboid ROI label type for labeling lidar point cloud data. You can also use the programmatic format, `labelType.Cuboid`.

`labelType('ProjectedCuboid')` creates a projected cuboid ROI label type for labeling image and video data. You can also use the programmatic format, `labelType.ProjectectedCuboid`.

`labelType('Scene')` creates a scene label type for labeling data across a specified time range. You can also use the programmatic format, `labelType.Scene`.

`labelType('Custom')` creates a custom label type. Labeler apps do not display labels of type Custom. You can also use the programmatic format, `labelType.Custom`.

Object Functions

`isCustom` Determine if label types are Custom labels
`isROI` Determine if label types are ROI labels
`isScene` Determine if label types are Scene labels

Examples

Specify Label Type in Label Definition Creator Object

Create a label definition creator object. Add a label named "Road" with the label type specified as a rectangle.

```
ldc = labelDefinitionCreator();
addLabel(ldc, 'Road', labelType.Rectangle);
```

Add a label named "Sky" with the label type specified as a scene.

```
addLabel(ldc, 'Sky', labelType.Scene);
```

Add a sublabel named "Lanes" to the label "Road". Specify the label type for the sublabel as a line.

```
addSublabel(ldc, 'Road', 'Lanes', labelType.Line);
```

Display the details of the definitions stored in the label definition creator object.

```
ldc
```

```
ldc =
labelDefinitionCreator contains the following labels:
```

```
    Road with 1 sublabels and 0 attributes and belongs to None group.    (info)
    Sky with 0 sublabels and 0 attributes and belongs to None group.    (info)
```

For more details about attributes and sublabels, use the `info` method.

Display information about the label "Road" as a structure by using the `info` function. The `Type` field in the structure `labelStruct` indicates the type of label.

```
labelStruct = info(ldc, 'Road')
```

```
labelStruct = struct with fields:
```

```
    Name: "Road"
    Type: Rectangle
    LabelColor: {''}
    Group: "None"
    Attributes: []
    Sublabels: "Lanes"
    Description: ''
```

See Also

Apps

Image Labeler | **Ground Truth Labeler** | **Video Labeler**

Objects

`groundTruth` | `labelDefinitionCreator` | `labelDefinitionCreatorMultisignal` | `groundTruthMultisignal` | `attributeType`

Introduced in R2017a

isCustom

Determine if label types are Custom labels

Syntax

```
tf = isCustom(labelTypes)
```

Description

`tf = isCustom(labelTypes)` returns a logical array that indicates which elements in `labelTypes` are Custom label types. `isCustom` returns logical 1 (true) for Custom labels and otherwise returns logical 0 (false).

Input Arguments

labelTypes — Type of labels

enumeration

Types of labels, specified as a `labelType` enumeration.

See Also

`isROI` | `isScene`

Introduced in R2017a

isROI

Determine if label types are ROI labels

Syntax

```
tf = isROI(labelTypes)
```

Description

`tf = isROI(labelTypes)` returns a logical array that indicates which elements in `labelTypes` are ROI label types. `isROI` returns logical 1 (true) for ROI labels and otherwise returns logical 0 (false). Valid ROI label types are `Rectangle`, `Cuboid`, `ProjectedCuboid`, `Line`, and `PixelLabel`.

Input Arguments

labelTypes — Type of labels

enumeration

Types of labels, specified as a `labelType` enumeration.

See Also

`isCustom` | `isScene`

Introduced in R2017a

isScene

Determine if label types are Scene labels

Syntax

```
tf = isScene(labelTypes)
```

Description

`tf = isScene(labelTypes)` returns a logical array that indicates which elements in `labelTypes` are Scene label types. `isScene` returns logical 1 (true) for Scene labels and otherwise returns logical 0 (false).

Input Arguments

labelTypes — Type of labels

enumeration

Types of labels, specified as a `labelType` enumeration.

See Also

`isCustom` | `isROI`

Introduced in R2017a

attributeType

Attribute type enumerations for labeling

Description

The `attributeType` enumerations enable you to specify the types of attributes used in these labeling apps: **Image Labeler**, **Video Labeler**, **Lidar Labeler**, and **Ground Truth Labeler** (requires Automated Driving Toolbox). When creating label definitions by using a `labelDefinitionCreator` or `labelDefinitionCreatorMultisignal` object, use these enumerations to create attributes of specific types.

Creation

Syntax

```
attributeType('Numeric')
attributeType('String')
attributeType('Logical')
attributeType('List')
attributeType('None')
```

Description

`attributeType('Numeric')` creates a numeric attribute type enumeration. Attributes of this type are numeric scalar values. You can also use the programmatic format, `attributeType.Numeric`.

`attributeType('String')` creates a string attribute type enumeration. Attributes of this type are string scalars. You can also use the programmatic format, `attributeType.String`.

`attributeType('Logical')` creates a logical attribute type enumeration. Attributes of this type are `true` (logical 1), `false` (logical 0), or an empty logical value. You can also use the programmatic format, `attributeType.Logical`.

`attributeType('List')` creates a list attribute type enumeration. Attributes of this type are lists of predefined strings. You can also use the programmatic format, `attributeType.List`.

`attributeType('None')` creates an enumeration whose type is not defined. You can also use the programmatic format, `attributeType.None`.

Object Functions

`hasValue` Determine if the attribute type is numeric or logical

Examples

Specify Attribute Type in Label Definition Creator Object

Create a label definition creator object and add a label named "Vehicle". Specify the type of label as a rectangle.

```
ldc = labelDefinitionCreator;  
addLabel(ldc, 'Vehicle', labelType.Rectangle);
```

Add an attribute named "Color" to the label "Vehicle". Specify the attribute type as a list.

```
addAttribute(ldc, 'Vehicle', 'Color', attributeType.List, {'White', 'Green', 'Blue'})
```

Display information about the attribute "Color" as a structure by using the `info` function. The `Type` field in the output structure `colorStruct` indicates the type of attribute.

```
colorStruct = info(ldc, 'Vehicle/Color')  
  
colorStruct = struct with fields:  
    Name: "Color"  
    Type: List  
    ListItems: {'White' 'Green' 'Blue'}  
    Description: ' '
```

See Also

Apps

[Image Labeler](#) | [Ground Truth Labeler](#) | [Video Labeler](#)

Objects

[labelType](#) | [labelDefinitionCreator](#) | [labelDefinitionCreatorMultisignal](#)

Introduced in R2018b

hasValue

Determine if the attribute type is numeric or logical

Syntax

```
tf = hasValue(typeOfAttribute)
```

Description

`tf = hasValue(typeOfAttribute)` returns a logical value that indicates if the enumerator in `typeOfAttribute` is either `Numeric` or `Logical`. `hasValue` returns logical 1 (true) for `Numeric` and `Logical` attributes. Otherwise returns logical 0 (false).

Examples

Determine the Type of Attribute

Create an `attributeType` enumeration array.

```
Type = attributeType({'Numeric'; 'String'; 'Logical'; 'List'});
```

Check if any of the enumerator defined in the `attributeType` enumeration array is `Numeric` or `Logical`.

```
tf = zeros(0, length(Type));  
for i = 1:length(Type)  
    tf(i) = hasValue(Type(i));  
end
```

Display the output. The value 1 is returned when an enumerator in the `attributeType` enumeration array is either `Numeric` or `Logical`. Otherwise, the value 0 is returned.

```
tf
```

```
tf = 1×4
```

```
    1    0    1    0
```

Input Arguments

typeOfAttribute — Type of attribute

`attributeType` enumeration

Type of attribute, specified as an `attributeType` enumeration. The enumerator in the `attributeType` enumeration can be `Numeric`, `String`, `Logical`, `List`, or `None`.

See Also

Objects

groundTruth | groundTruthMultisignal | labelDefinitionCreator |
labelDefinitionCreatorMultisignal | attributeType

Introduced in R2018b

cameraParameters

Object for storing camera parameters

Description

The cameraParameters object stores the intrinsic, extrinsic, and lens distortion parameters of a camera.

Creation

You can create a cameraParameters object using the cameraParameters function described here. You can also create a cameraParameters object by using the estimateCameraParameters with an M -by-2-by-*numImages* array of input image points. M is the number of keypoint coordinates in each pattern.

Syntax

```
cameraParams = cameraParameters  
cameraParams = cameraParameters(Name,Value)  
cameraParams = cameraParameters(paramStruct)
```

Description

cameraParams = cameraParameters creates a cameraParameters object that contains the intrinsic, extrinsic, and lens distortion parameters of a camera.

cameraParams = cameraParameters(Name,Value) sets properties on page 2-868 of the cameraParameters object by using one or more Name, Value pair arguments. Unspecified properties use default values.

cameraParams = cameraParameters(paramStruct) creates an identical cameraParameters object from an existing cameraParameters object with parameters stored in paramStruct.

Input Arguments

paramStruct — Camera parameters

struct

Stereo parameters, specified as a stereo parameters struct. To get a paramStruct from an existing cameraParameters object, use the toStruct function.

Properties

Intrinsic Camera Parameters:

IntrinsicMatrix — Projection matrix

3-by-3 identity matrix

Projection matrix, specified as a 3-by-3 identity matrix. The object uses the following format for the matrix format:

$$\begin{bmatrix} f_x & 0 & 0 \\ s & f_y & 0 \\ c_x & c_y & 1 \end{bmatrix}$$

The coordinates $[c_x \ c_y]$ represent the optical center (the principal point), in pixels. When the x and y axis are exactly perpendicular, the skew parameter, s , equals 0.

$$f_x = F*s_x$$

$$f_y = F*s_y$$

F , is the focal length in world units, typically expressed in millimeters.

$[s_x, s_y]$ are the number of pixels per world unit in the x and y direction respectively.

f_x and f_y are expressed in pixels.

Intrinsics – Camera intrinsics object

cameraIntrinsics object

This property is read-only.

Camera intrinsics object, stated as a cameraIntrinsics object. The object contains information about camera intrinsic calibration parameters, including lens distortion.

Dependency

You must provide an image size (using the ImageSize property) for the Intrinsics property to be non-empty. The intrinsics for the camera parameters depends on the image size.

ImageSize – Image size

two-elment vector

Image size, specified as a two-element vector $[mrows,ncols]$.

Camera Lens Distortion:

RadialDistortion – Radial distortion coefficients

$[0 \ 0 \ 0]$ (default) | 2-element vector | 3-element vector

Radial distortion coefficients, specified as either a two- or three-element vector. When you specify a two-element vector, the object sets the third element to 0. Radial distortion occurs when light rays bend more near the edges of a lens than they do at its optical center. The smaller the lens, the greater the distortion. The camera parameters object calculates the radial distorted location of a point. You can denote the distorted points as $(x_{\text{distorted}}, y_{\text{distorted}})$, as follows:

$$x_{\text{distorted}} = x(1 + k_1*r^2 + k_2*r^4 + k_3*r^6)$$

$$y_{\text{distorted}} = y(1 + k_1*r^2 + k_2*r^4 + k_3*r^6)$$

x, y = undistorted pixel locations

$k_1, k_2,$ and k_3 = radial distortion coefficients of the lens

$$r^2 = x^2 + y^2$$

Typically, two coefficients are sufficient. For severe distortion, you can include k_3 . The undistorted pixel locations appear in normalized image coordinates, with the origin at the optical center. The coordinates are expressed in world units.

TangentialDistortion — Tangential distortion coefficients

[0 0]' (default) | 2-element vector

Tangential distortion coefficients, specified as a two-element vector. Tangential distortion occurs when the lens and the image plane are not parallel. The camera parameters object calculates the tangential distorted location of a point. You can denote the distorted points as $(x_{\text{distorted}}, y_{\text{distorted}})$. The undistorted pixel locations appear in normalized image coordinates, with the origin at the optical center. The coordinates are expressed in world units.

Tangential distortion occurs when the lens and the image plane are not parallel. The tangential distortion coefficients model this type of distortion.

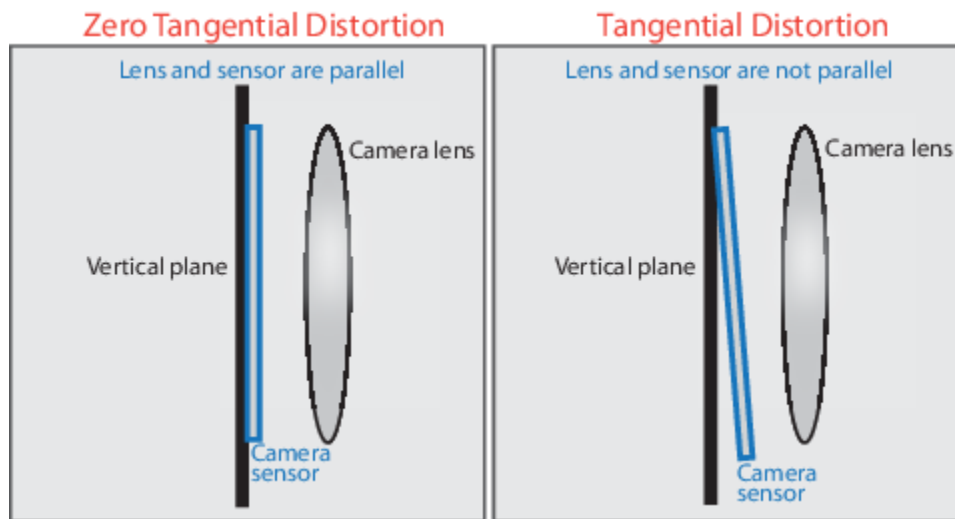

The distorted points are denoted as $(x_{\text{distorted}}, y_{\text{distorted}})$:

$$x_{\text{distorted}} = x + [2 * p_1 * x * y + p_2 * (r^2 + 2 * x^2)]$$

$$y_{\text{distorted}} = y + [p_1 * (r^2 + 2 * y^2) + 2 * p_2 * x * y]$$

- x, y — Undistorted pixel locations. x and y are in normalized image coordinates. Normalized image coordinates are calculated from pixel coordinates by translating to the optical center and dividing by the focal length in pixels. Thus, x and y are dimensionless.
- p_1 and p_2 — Tangential distortion coefficients of the lens.
- $r^2 = x^2 + y^2$

Extrinsic Camera Parameters:**RotationMatrices — 3-D rotation matrix**

3-by-3-by- P matrix (read-only)

3-D rotation matrix, specified as a 3-by-3-by- P , with P number of pattern images. Each 3-by-3 matrix represents the same 3-D rotation as the corresponding vector.

The following equation provides the transformation that relates a world coordinate in the checkerboard frame $[X Y Z]$ and the corresponding image point $[x y]$:

$$s[x \ y \ 1] = [X \ Y \ Z \ 1] \begin{bmatrix} R \\ t \end{bmatrix} K$$

R is the 3-D rotation matrix.

t is the translation vector.

K is the `IntrinsicMatrix`.

s is a scalar.

This equation does not take distortion into consideration. The `undistortImage` function removes distortion.

RotationVectors — 3-D rotation vectors

[] (default) | P -by-3 matrix (read-only)

3-D rotation vectors, specified as a P -by-3 matrix containing P rotation vectors. Each vector describes the 3-D rotation of the camera image plane relative to the corresponding calibration pattern. The vector specifies the 3-D axis about which the camera is rotated, where the magnitude is the rotation angle in radians. The `RotationMatrices` property provides the corresponding 3-D rotation matrices.

TranslationVectors — Camera translations

[] (default) | P -by-3 matrix

Camera translations, specified as an P -by-3 matrix. This matrix contains translation vectors for P images. The vectors contain the calibration pattern that estimates the calibration parameters. Each row of the matrix contains a vector that describes the translation of the camera relative to the corresponding pattern, expressed in world units.

The following equation provides the transformation that relates a world coordinate in the checkerboard frame $[X\ Y\ Z]$ and the corresponding image point $[x\ y]$:

$$s[x\ y\ 1] = [X\ Y\ Z\ 1] \begin{bmatrix} R \\ t \end{bmatrix} K$$

R is the 3-D rotation matrix.

t is the translation vector.

K is the `IntrinsicMatrix`.

s is a scalar.

This equation does not take distortion into consideration. The `undistortImage` function removes distortion.

To ensure that the number of rotation vectors equals the number of translation vectors, set the `RotationVectors` and `TranslationVectors` properties in the constructor. Setting only one property but not the other results in an error.

Estimated Camera Parameter Accuracy:

MeanReprojectionError — Average Euclidean distance

numeric value (read-only)

Average Euclidean distance between reprojected and detected points, specified as a numeric value in pixels.

ReprojectionErrors — Estimated camera parameters accuracy

[] (default) | M -by-2-by- P array

Estimated camera parameters accuracy, specified as an M -by-2-by- P array of $[x\ y]$ coordinates. The $[x\ y]$ coordinates represent the translation in x and y between the reprojected pattern key points and

the detected pattern key points. The values of this property represent the accuracy of the estimated camera parameters. P is the number of pattern images that estimates camera parameters. M is the number of keypoints in each image.

ReprojectedPoints — World points reprojected onto calibration images

M -by-2-by- P array

World points reprojected onto calibration images, specified as an M -by-2-by- P array of $[x\ y]$ coordinates. P is the number of pattern images and M is the number of keypoints in each image. Missing points in the pattern's detected keypoints are denoted as $[NaN, NaN]$.

DetectedKeypoints — Detected keypoints in the calibration pattern

`[]` (default) | M -by- P array

Detected keypoints in the calibration pattern, specified as a logical M -by- P array. M is the number of keypoints in the entire calibration pattern and P specifies the number of calibration images.

Settings for Camera Parameter Estimation:**NumPatterns — Number of calibrated patterns**

integer

Number of calibration patterns that estimates camera extrinsics, specified as an integer. The number of calibration patterns equals the number of translation and rotation vectors.

WorldPoints — World coordinates

M -by-2 array | `[]`

World coordinates of key points on calibration pattern, specified as an M -by-2 array. M represents the number of key points in the pattern.

WorldUnits — World points units

'mm' (default) | character vector | string scalar

World points units, specified as a character vector or string scalar. The value describes the units of measure.

EstimateSkew — Estimate skew flag

`false` (default) | logical scalar

Estimate skew flag, specified as a logical scalar. When you set the logical to `true`, the object estimates the image axes skew. When you set the logical to `false`, the image axes are exactly perpendicular.

NumRadialDistortionCoefficients — Number of radial distortion coefficients

2 (default) | 3

Number of radial distortion coefficients, specified as the number '2' or '3'.

EstimateTangentialDistortion — Estimate tangential distortion flag

`false` (default) | logical scalar

Estimate tangential distortion flag, specified as the logical scalar `true` or `false`. When you set the logical to `true`, the object estimates the tangential distortion. When you set the logical to `false`, the tangential distortion is negligible.

Examples

Remove Distortion from an Image Using the Camera Parameters Object

Use the camera calibration functions to remove distortion from an image. This example creates a `vision.cameraParameters` object manually, but in practice, you would use the `estimateCameraParameters` or the Camera Calibrator app to derive the object.

Create a `vision.cameraParameters` object manually.

```
IntrinsicMatrix = [715.2699 0 0; 0 711.5281 0; 565.6995 355.3466 1];
radialDistortion = [-0.3361 0.0921];
cameraParams = cameraParameters('IntrinsicMatrix',IntrinsicMatrix,'RadialDistortion',radialDistortion);
```

Remove distortion from the images.

```
I = imread(fullfile(matlabroot,'toolbox','vision','visiondata','calibration','mono','image01.jpg'));
J = undistortImage(I,cameraParams);
```

Display the original and the undistorted images.

```
figure; imshowpair(imresize(I,0.5),imresize(J,0.5),'montage');
title('Original Image (left) vs. Corrected Image (right)');
```



References

- [1] Zhang, Z. "A flexible new technique for camera calibration". *IEEE Transactions on Pattern Analysis and Machine Intelligence*, Vol. 22, No. 11, pp. 1330-1334, 2000.
- [2] Heikkila, J, and O. Silven. "A Four-step Camera Calibration Procedure with Implicit Image Correction", *IEEE International Conference on Computer Vision and Pattern Recognition*, 1997.

Extended Capabilities

C/C++ Code Generation

Generate C and C++ code using MATLAB® Coder™.

Usage notes and limitations:

- Use the `toStruct` method to pass a `cameraParameters` object into generated code. See the “Code Generation for Depth Estimation From Stereo Video” example.

See Also

Apps

[Camera Calibrator](#) | [Stereo Camera Calibrator](#)

Classes

[stereoParameters](#) | [cameraCalibrationErrors](#) | [intrinsicEstimationErrors](#) | [extrinsicEstimationErrors](#) | [cameraIntrinsic](#)

Functions

[worldToImage](#) | [pointsToWorld](#) | [estimateCameraParameters](#) | [showReprojectionErrors](#) | [showExtrinsic](#) | [undistortImage](#) | [detectCheckerboardPoints](#) | [generateCheckerboardPoints](#)

Topics

“Measuring Planar Objects with a Calibrated Camera”

“Code Generation for Depth Estimation From Stereo Video”

“Using the Single Camera Calibrator App”

Introduced in R2014a

fisheyeCalibrationErrors

Object for storing standard errors of estimated fisheye camera parameters

Description

`fisheyeCalibrationErrors` contains the standard errors of estimated camera parameters. You can access the standard errors of the intrinsics and extrinsics by using the object properties. To display the standard errors, use the `displayErrors` function.

Creation

The `estimateFisheyeParameters` function returns the `fisheyeCalibrationErrors` object.

Properties

IntrinsicsErrors — Standard errors of estimated intrinsics

`fisheyeIntrinsicsEstimationErrors` object

Standard errors of the estimated intrinsics for a fisheye camera, specified as a `fisheyeIntrinsicsEstimationErrors` object.

ExtrinsicsErrors — Standard errors of estimated rotations and translations

`extrinsicsEstimationErrors` object

Standard errors of the estimated rotations and translations for a fisheye camera relative to the calibration pattern, specified as a `extrinsicsEstimationErrors` object.

Object Functions

`displayErrors` Display standard errors of camera parameter estimates

Examples

Display Fisheye Camera Calibration Errors

Gather a set of checkerboard calibration images.

```
images = imageDatastore(fullfile(toolboxdir('vision'),'visiondata',...
    'calibration','gopro'));
```

Detect the calibration pattern from the images.

```
[imagePoints,boardSize] = detectCheckerboardPoints(images.Files);
```

Generate world coordinates for the corners of the checkerboard squares.

```
squareSize = 29; % millimeters
worldPoints = generateCheckerboardPoints(boardSize,squareSize);
```

Estimate the fisheye parameters using image and world points. Use the first image to get the image size. Also, store the errors from the calibration.

```
I = readimage(images,1);
imageSize = [size(I,1) size(I,2)];
[params,~,errors] = estimateFisheyeParameters(imagePoints, ...
                                             worldPoints,imageSize);
```

Display the standard errors of the estimated camera parameters.

```
displayErrors(errors,params);
```

Standard Errors of Estimated Camera Parameters

Intrinsics

```
Mapping coefficients: [ 875.0783 +/- 0.9451      -0.0003 +/- -0.0000      -0.0000 +/- 0.0000
Distortion center (pixels):[ 1005.8164 +/- 0.6871      743.0346 +/- 0.5578      ]
Stretch matrix parameters:[ 1.0000 +/- 0.0000      0.0000 +/- 0.0000      0.0000 +/- 0.0000
```

Extrinsics

Rotation vectors:

```
[ -0.0699 +/- 0.0010      -0.0267 +/- 0.0009      0.0258 +/- 0.0003
[ 0.3628 +/- 0.0010      0.2950 +/- 0.0009      -0.1967 +/- 0.0003
[ -0.2159 +/- 0.0009      0.3442 +/- 0.0009      -0.1941 +/- 0.0003
[ 0.0282 +/- 0.0009      -0.3784 +/- 0.0009      0.0829 +/- 0.0003
[ 0.0146 +/- 0.0008      0.4575 +/- 0.0009      -0.1215 +/- 0.0003
[ 0.6775 +/- 0.0008      0.1089 +/- 0.0008      -0.0386 +/- 0.0003
[ -0.4936 +/- 0.0008      0.0063 +/- 0.0008      0.0486 +/- 0.0003
[ 0.3823 +/- 0.0008      0.2797 +/- 0.0008      0.1509 +/- 0.0003
[ 0.5171 +/- 0.0008      -0.3295 +/- 0.0008      0.0541 +/- 0.0003
[ -0.1896 +/- 0.0008      -0.3543 +/- 0.0009      0.2637 +/- 0.0003
[ -0.2911 +/- 0.0008      0.3680 +/- 0.0008      -0.1329 +/- 0.0003
```

Translation vectors (mm):

```
[ -132.9182 +/- 0.1609      -82.6066 +/- 0.1356      195.1106 +/- 0.2311
[ -178.9931 +/- 0.1905      -15.7750 +/- 0.1712      241.7127 +/- 0.2799
[ -183.7957 +/- 0.2168      -56.7378 +/- 0.1884      269.9740 +/- 0.2799
[ -17.6295 +/- 0.1315      -70.2875 +/- 0.1041      157.0827 +/- 0.1933
[ -161.9824 +/- 0.1808      -46.9681 +/- 0.1569      228.4061 +/- 0.2307
[ -122.4240 +/- 0.1309      -16.0260 +/- 0.1153      162.6247 +/- 0.2073
[ -112.4268 +/- 0.1745      -125.5876 +/- 0.1428      212.8055 +/- 0.2150
[ -148.7137 +/- 0.1387      -72.5409 +/- 0.1260      173.7615 +/- 0.2080
[ -49.5392 +/- 0.0919      -24.8329 +/- 0.0745      104.3541 +/- 0.1500
[ -3.4045 +/- 0.1274      -93.4074 +/- 0.1010      155.8247 +/- 0.1693
[ -160.7344 +/- 0.1855      -51.9152 +/- 0.1600      234.4075 +/- 0.2311
```

See Also

[fisheyeParameters](#) | [estimateFisheyeParameters](#) |
[fisheyeIntrinsicsEstimationErrors](#) | [extrinsicsEstimationErrors](#)

Topics

“Fisheye Calibration Basics”
“Configure Monocular Fisheye Camera” (Automated Driving Toolbox)

Introduced in R2017b

fisheyeIntrinsics

Object for storing intrinsic fisheye camera parameters

Description

The `fisheyeIntrinsics` object stores the camera intrinsics for a fisheye camera. See `fisheyeParameters` for details on other fisheye parameters.

Creation

Syntax

```
intrinsics = fisheyeIntrinsics(mappingCoeffs, imageSize, distortionCenter)
intrinsics = fisheyeIntrinsics( ____, stretchMatrix)
```

Description

`intrinsics = fisheyeIntrinsics(mappingCoeffs, imageSize, distortionCenter)` returns a `fisheyeIntrinsics` object with the specified `[a0 a2 a3 a4]` polynomial coefficients, image size, and center of distortion. These input arguments are assigned directly to the corresponding properties of the object. See `fisheyeParameters` for more details.

`intrinsics = fisheyeIntrinsics(____, stretchMatrix)` additionally specifies a 2-by-2 transformation matrix that describes the alignment between the sensor plane and the image plane. The default value is an identity matrix.

Properties

MappingCoefficients — Polynomial coefficients for projection function

`[a0 a2 a3 a4]` vector

This property is read-only.

Polynomial coefficients for the projection function described by Scaramuzza's Taylor model, specified as an `[a0 a2 a3 a4]` vector.

DistortionCenter — Center of distortion in pixels

`[cx cy]` vector

This property is read-only.

Center of distortion in pixels, specified as a `[cx cy]` vector.

Stretchmatrix — Transformation from sensor plane to pixel in camera image plane

2-by-2 transformation matrix

This property is read-only.

Transformation from the sensor plane to a pixel in the camera image plane, specified as a 2-by-2 transformation matrix. This misalignment is caused by the lens not being parallel to the sensor and by the digitization process.

ImageSize — Image size

[mrows ncols] vector

This property is read-only.

Image size, specified as an [mrows ncols] vector.

Examples

Create Fisheye Intrinsics

Specify the mapping coefficients, image size, and distortion center parameters of a `fisheyeIntrinsics` object. Ignore optical axis misalignment.

```
mappingCoeffs = [880 -3e-4 0 0];    % mapping polynomial coefficients
imageSize = [1500 2000];          % in [mrows ncols]
distortionCenter = [1000 750];     % in pixels

intrinsics = fisheyeIntrinsics(mappingCoeffs,imageSize,distortionCenter);
```

References

- [1] Scaramuzza, D., A. Martinelli, and R. Siegwart. "A Toolbox for Easy Calibrating Omnidirectional Cameras." *Proceedings to IEEE International Conference on Intelligent Robots and Systems (IROS 2006)*. Beijing, China, October 7–15, 2006.
- [2] Urban, S., J. Leitloff, and S. Hinz. "Improved Wide-Angle, Fisheye and Omnidirectional Camera Calibration." *ISPRS Journal of Photogrammetry and Remote Sensing*. Vol. 108, 2015, pp.72–79.

Extended Capabilities

C/C++ Code Generation

Generate C and C++ code using MATLAB® Coder™.

See Also

Functions

`estimateFisheyeParameters` | `worldToImage` | `pointsToWorld`

Objects

`fisheyeParameters`

Topics

"Fisheye Calibration Basics"

"Configure Monocular Fisheye Camera" (Automated Driving Toolbox)

Introduced in R2017b

fisheyeIntrinsicsEstimationErrors

Object for storing standard errors of estimated fisheye camera intrinsics

Description

`fisheyeIntrinsicsEstimationErrors` contains the standard errors of estimated fisheye camera intrinsics.

Creation

The `estimateFisheyeParameters` function returns the `fisheyeCalibrationErrors` object, which contains `fisheyeIntrinsicsEstimationErrors` and `extrinsicsEstimationErrors` as properties.

Properties

MappingCoefficientsError — Standard error of mapping coefficient estimates

4-element vector

Standard error of mapping coefficient estimates, specified as a 4-element vector.

DistortionCenterError — Standard error of distortion center estimates

2-element vector

Standard error of distortion center estimates, specified as a two-element vector.

StretchMatrixError — Standard error of stretch matrix estimate

3-element vector

Standard error of stretch matrix estimate, specified as a 3-element vector.

See Also

`cameraCalibrationErrors` | `stereoCalibrationErrors`

Topics

“Fisheye Calibration Basics”

“Configure Monocular Fisheye Camera” (Automated Driving Toolbox)

Introduced in R2017b

fisheyeParameters

Object for storing fisheye camera parameters

Description

The `fisheyeParameters` object is used to store fisheye camera parameters. Use `estimateFisheyeParameters` to estimate parameters using calibration images.

Creation

Syntax

```
fisheyeParams = fisheyeParameters(intrinsics)
fisheyeParams = fisheyeParameters(intrinsics,Name,Value)
```

Description

`fisheyeParams = fisheyeParameters(intrinsics)` returns an object that contains intrinsic and extrinsic parameters of a fisheye camera. `intrinsics` must be a `fisheyeIntrinsics` object. This syntax sets the `Intrinsics` property of the object.

`fisheyeParams = fisheyeParameters(intrinsics,Name,Value)` configures the `fisheyeParams` object properties using one or more `Name,Value` pair arguments. Enclose the property name in single quotes. Unspecified properties have their default values. For example, `'WorldUnits', 'm'` sets the world units to `'m'`.

Properties

Intrinsic Camera Parameters

Intrinsics — Fisheye intrinsic camera parameters

`fisheyeIntrinsics` object

Fisheye intrinsic camera parameters, specified as a `fisheyeIntrinsics` object.

Extrinsic Camera Parameters

RotationVectors — Camera rotations

`[]` (default) | M -by-3 matrix

Camera rotations, specified as an M -by-3 matrix. The matrix contains rotation vectors for M images, where each image contains the calibration pattern that estimates the calibration parameters. Each row of the matrix contains a vector that describes the 3-D rotation of the camera relative to the corresponding pattern.

Each vector specifies the 3-D axis about which the camera is rotated. The magnitude of the vector represents the angle of rotation in radians. You can convert any rotation vector to a 3-by-3 rotation matrix using the Rodrigues formula.

To ensure that the number of rotation vectors equals the number of translation vectors, you must set the `RotationVectors` and `TranslationVectors` properties together when creating the object. Setting only one property results in an error.

TranslationVectors — Camera translations

[] (default) | M -by-3 matrix

Camera translations, specified as an M -by-3 matrix. This matrix contains translation vectors for M images. The vectors contain the calibration pattern that estimates the calibration parameters. Each row of the matrix contains a vector that describes the translation of the camera relative to the corresponding pattern, expressed in world units.

To ensure that the number of rotation vectors equals the number of translation vectors, you must set the `RotationVectors` and `TranslationVectors` properties together when creating the object. Setting only one property results in an error.

Accuracy of Estimated Camera Parameters

ReprojectionErrors — Reprojection errors

[] (default) | M -by-2-by- P array

Reprojection errors, specified as an M -by-2-by- P array of $[x,y]$ pairs. The $[x,y]$ pairs represent the translation in x and y between the reprojected pattern keypoints and the detected pattern keypoints.

ReprojectedPoints — World points reprojected onto calibration images

M -by-2-by- P array

World points reprojected onto calibration images, specified as an M -by-2-by- P array of $[x y]$ coordinates. P is the number of pattern images and M is the number of keypoints in each image. Missing points in the pattern's detected keypoints are denoted as `[NaN, NaN]`.

DetectedKeypoints — Detected keypoints in the calibration pattern

[] | M -by- P array

Detected keypoints in the calibration pattern, specified as a logical M -by- P array. M is the number of keypoints in the entire calibration pattern and P specifies the number of calibration images.

Settings Used to Estimate Camera Parameters

NumPatterns — Number of calibrated patterns

integer

Number of calibration patterns used to estimate camera extrinsics, specified as an integer. The number of calibration patterns must equal the number of translation and rotation vectors.

WorldPoints — World coordinates

[] (default) | M -by-2 matrix

World coordinates of key points on the calibration pattern, specified as an M -by-2 matrix. M represents the number of key points in the pattern.

WorldUnits — World point units

'mm' (default) | character vector | string scalar

World point units, specified as the comma-separated pair consisting of 'WorldUnits' and a character vector or string scalar. This argument is used simply to store the unit type and does not affect any calculations.

EstimateAlignment — Estimate axes alignment

false (default) | true

Estimate axes alignment, specified as false or true. Set to true if the optical axis of the fisheye lens is not perpendicular to the image plane.

Examples

Create Fisheye Parameters Object Manually

Create a fisheye parameters object by specifying the properties manually. Alternatively, you can create this object using the `estimateFisheyeParameters` function.

Specify fisheye intrinsics.

```
mappingCoefficients = rand(1,4);
distortionCenter = [320 240];
imageSize = [480 640];
intrinsics = fisheyeIntrinsics(mappingCoefficients,imageSize,distortionCenter);
```

Create a `fisheyeParameters` object using the specified intrinsics.

```
params = fisheyeParameters(intrinsics);
```

References

- [1] Scaramuzza, D., A. Martinelli, and R. Siegwart. "A Toolbox for Easy Calibrating Omnidirectional Cameras." *Proceedings to IEEE International Conference on Intelligent Robots and Systems (IROS 2006)*. Beijing, China, October 7-15, 2006.
- [2] Urban, S., J. Leitloff, and S. Hinz. "Improved Wide-Angle, Fisheye and Omnidirectional Camera Calibration." *ISPRS Journal of Photogrammetry and Remote Sensing*. Vol. 108, 2015, pp.72-79.

Extended Capabilities

C/C++ Code Generation

Generate C and C++ code using MATLAB® Coder™.

See Also

`estimateFisheyeParameters` | `undistortFisheyeImage` | `fisheyeIntrinsics` | `showExtrinsics` | `showReprojectionErrors`

Topics

"Fisheye Calibration Basics"

"Configure Monocular Fisheye Camera" (Automated Driving Toolbox)

Introduced in R2017b

velodyneFileReader

Read point cloud data from Velodyne PCAP file

Description

The `velodyneFileReader` object reads point cloud data from a Velodyne® packet capture (PCAP) file.

Creation

Syntax

```
veloReader = velodyneFileReader(fileName,deviceModel)
veloReader = velodyneFileReader(fileName,
deviceModel,'CalibrationFile',calibFile)
```

Description

`veloReader = velodyneFileReader(fileName,deviceModel)` creates a Velodyne file reader that reads in point cloud data. Specify the PCAP file and the device model that generated the file. The inputs set the `FileName` and `DeviceModel` properties directly. The reader supports the VLP-16, Puck LITE, Puck Hi-Res, VLP-32C, HDL-32E, HDL-64E, and VLS-128 device models.

The VLS-128 device model returns point cloud data in a format that requires additional processing in order to use it with the `segmentLidarData` or the `segmentGroundFromLidarData` functions. You can use the `pcorganize` function before using these functions to format the data.

`veloReader = velodyneFileReader(fileName,deviceModel,'CalibrationFile',calibFile)` specifies the Velodyne calibration XML file and sets the `CalibrationFile` property.

Properties

FileName — Velodyne PCAP file name

character vector | string scalar

This property is read-only.

Name of Velodyne PCAP file to read lidar data from, specified as a character vector or string scalar.

DeviceModel — Velodyne device model name

'VLP16' | 'PuckLITE' | 'PuckHiRes' | 'VLP32C' | 'HDL32E' | 'HDL64E' | 'VLS128'

This property is read-only.

Velodyne device model name, specified as 'VLP16', 'PuckLITE', 'PuckHiRes', 'VLP32C', 'HDL32E', 'HDL64E', or 'VLS128'.

Note Specifying the incorrect device model returns an improperly calibrated point cloud.

CalibrationFile — Name of Velodyne calibration XML file

character vector | string scalar

This property is read-only.

Name of the Velodyne calibration XML file, specified as a character vector or string scalar. This calibration file is included with every sensor.

NumberOfFrames — Total number of point clouds

positive integer

This property is read-only.

Total number of point clouds in the file, specified as a positive integer.

Duration — Total duration of file in seconds

duration scalar

This property is read-only.

Total duration of the file in seconds, specified as a duration scalar.

StartTime — Time of first point cloud reading

duration scalar

This property is read-only.

Time of the first point cloud, specified as a duration scalar in seconds.

Start and end times are specified relative to the previous whole hour. For instance, if the file is recorded for 7 minutes from 1:58 p.m. to 2:05 p.m., then:

- $StartTime = 58 \text{ min} \times 60 \text{ s} = 3840 \text{ s}$
- $EndTime = StartTime + 7 \text{ min} \times 60 \text{ s} = 3900 \text{ s}$

EndTime — Time of last point cloud reading

duration scalar

This property is read-only.

Time of the last point cloud reading, specified as a duration scalar.

Start and end times are specified relative to the previous whole hour. For instance, if the file is recorded for 7 minutes from 1:58 PM to 2:05 PM, then:

- $StartTime = 58 \text{ min} \times 60 \text{ s} = 3840 \text{ s}$
- $EndTime = StartTime + 7 \text{ min} \times 60 \text{ s} = 3900 \text{ s}$

CurrentTime — Time of current point cloud reading

duration scalar

Time for the current point cloud reading in seconds, specified as a duration scalar. As you read point clouds using `readFrame`, this property is updated with the most recent point cloud reading

time. You can use `reset` to reset the value of this property to the default value. The default value matches the `StartTime` property.

Timestamps — Start time for each point cloud frame

`duration` vector

This property is read-only.

Start time for each point cloud frame in seconds, specified as a `duration` vector. The length of the vector is equal to the value of `NumberOfFrames` property. The value of first element in the vector is same as that of the `StartTime` property. You can use this property to read point cloud frames captured at different times.

For example, read start time of a point cloud frame from the `Timestamps` property. Pass the start time as an input to the `readFrame` function and read the corresponding point cloud frame.

```
veloReader = velodyneFileReader('lidarData_ConstructionRoad.pcap', 'HDL32E')
frameTime = veloReader.Timestamps(10);
ptCloud = readFrame(veloReader, frameTime);
```

Object Functions

<code>hasFrame</code>	Determine if another Velodyne point cloud is available
<code>readFrame</code>	Read Velodyne point cloud from file
<code>reset</code>	Reset the <code>CurrentTime</code> property of <code>velodyneFileReader</code> object to the default value

Examples

Display Point Clouds from Velodyne PCAP File

Use the `velodyneFileReader` to read a packet capture (PCAP) file from a Velodyne® sensor. View point clouds using `pcplayer`.

Read in point clouds by using a Velodyne® file reader. Specify the PCAP file to read and the Velodyne® device model.

```
veloReader = velodyneFileReader('lidarData_ConstructionRoad.pcap', 'HDL32E');
```

Define *x*-, *y*-, and *z*-axes limits for `pcplayer` in meters. Label the axes.

```
xlimits = [-60 60];
ylimits = [-60 60];
zlimits = [-20 20];
```

Create the point cloud player.

```
player = pcplayer(xlimits, ylimits, zlimits);
```

Label the axes.

```
xlabel(player.Axes, 'X (m)');
ylabel(player.Axes, 'Y (m)');
zlabel(player.Axes, 'Z (m)');
```

The first point cloud of interest is captured at 0.3 second into the file. Set the `CurrentTime` property to that time to begin reading point clouds from there.

```
veloReader.CurrentTime = veloReader.StartTime + seconds(0.3);
```

Display the point cloud stream for 10 seconds. Remove the last `while` condition to display the full stream.

Use `hasFrame` to check if a new frame is available. Iterate through the file by calling `readFrame` to read in point clouds. Display them using the point cloud player. Remove the last `while` condition to display the full stream.

```
while(hasFrame(veloReader) && player.isOpen() && (veloReader.CurrentTime < veloReader.StartTime + 10))
    ptCloudObj = readFrame(veloReader);
    view(player,ptCloudObj.Location,ptCloudObj.Intensity);
    pause(0.1);
end
```

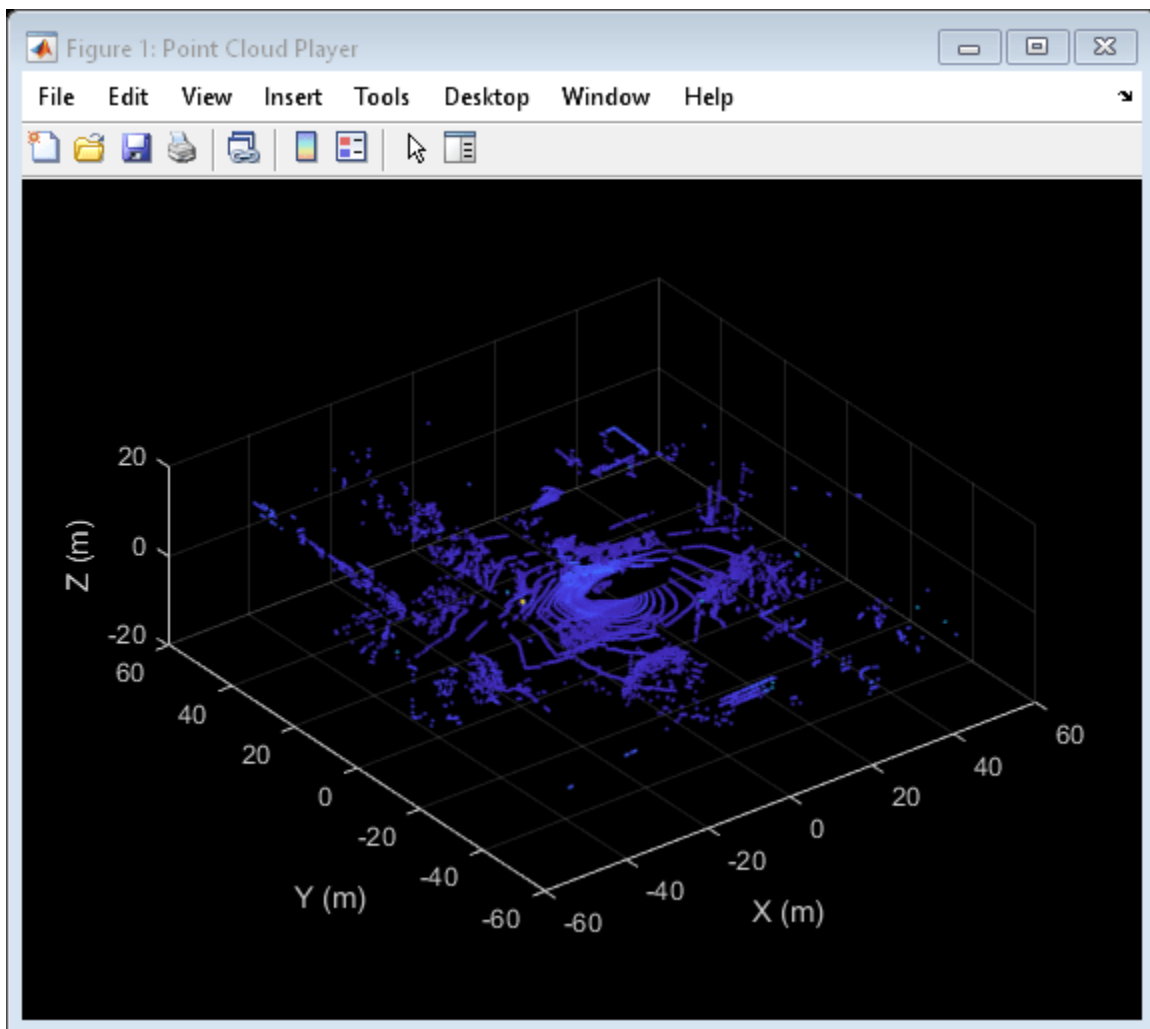

See Also

Functions

`pcplayer` | `readFrame` | `hasFrame` | `reset` | `pcshow` | `pcread`

Objects

pcplayer | pointCloud

Topics

“Lidar Toolbox Supported Hardware” (Lidar Toolbox)

Velodyne LiDAR Sensors Data Acquisition (Lidar Toolbox Support Package for Velodyne LiDAR Sensors)

“Build a Map from Lidar Data”

External Websites

Velodyne Manuals

Introduced in R2018a

hasFrame

Determine if another Velodyne point cloud is available

Syntax

```
isAvailable = hasFrame(veloReader)
```

Description

`isAvailable = hasFrame(veloReader)` determines if another point cloud is available in the packet capture (PCAP) file of the input Velodyne file reader. As you read point clouds using `readFrame`, the point clouds are read sequentially until this function returns `false`.

Examples

Check for Next Point Cloud in Velodyne PCAP File

Create a `velodyneFileReader` object to read a Velodyne® packet capture (PCAP) file and check for available frames using `hasFrame`.

Read in a point cloud by using a Velodyne® file reader. Specify the PCAP file to be read and Velodyne® device model.

```
veloReader = velodyneFileReader('lidarData_ConstructionRoad.pcap', 'HDL32E');
```

Check if the file reader has a point cloud to read.

```
disp(hasFrame(veloReader));
```

```
1
```

Read the last frame of the file.

```
ptCloudObj = readFrame(veloReader,veloReader.NumberOfFrames);
```

Check again if the file reader has another point cloud available.

```
disp(hasFrame(veloReader));
```

```
0
```

Input Arguments

veloReader — Velodyne file reader

`velodyneFileReader` object

Velodyne file reader, specified as a `velodyneFileReader` object.

Output Arguments

isAvailable — Indicator if frame is available

true | false

Indicator if frame is available, returned as true or false.

See Also

velodyneFileReader | readFrame | reset | pcplayer | pointCloud | pcshow

External Websites

Velodyne Manuals

Introduced in R2018a

readFrame

Read Velodyne point cloud from file

Syntax

```
ptCloud = readFrame(veloReader)
ptCloud = readFrame(veloReader, frameNumber)
ptCloud = readFrame(veloReader, frameTime)
```

Description

`ptCloud = readFrame(veloReader)` reads the next point cloud in sequence from the Velodyne PCAP file and returns a `pointCloud` object.

`ptCloud = readFrame(veloReader, frameNumber)` reads the point cloud with the specific frame number from the file.

`ptCloud = readFrame(veloReader, frameTime)` reads the first point cloud recorded at or after the given `frameTime`.

Examples

Read Point Cloud from File Using Time Duration

Create a `velodyneFileReader` object to read a Velodyne® packet capture (PCAP) file and select specific point clouds using a `duration` scalar.

Read in point clouds by using a Velodyne® file reader. Specify the PCAP file to read and the Velodyne® device model.

```
veloReader = velodyneFileReader('lidarData_ConstructionRoad.pcap', 'HDL32E');
```

Create a `duration` scalar that represents three seconds after the first point cloud reading.

```
timeDuration = veloReader.StartTime + duration(0,0,3, 'Format', 's');
```

Read the first point cloud recorded at or after the given time duration.

```
ptCloudObj = readFrame(veloReader, timeDuration);
```

Display the point cloud using `pcshow`.

```
figure
pcshow(ptCloudObj)
```

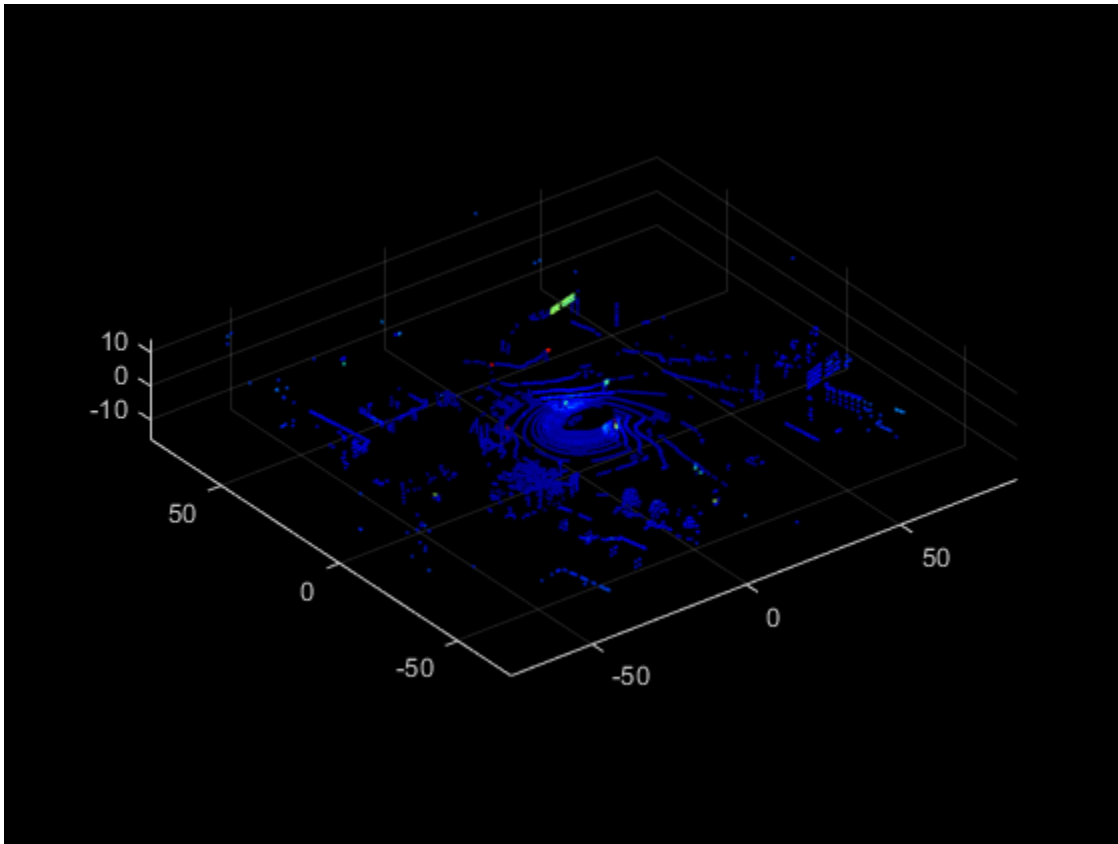

Input Arguments

veloReader — Velodyne file reader

velodyneFileReader object

Velodyne file reader, specified as a velodyneFileReader object.

frameNumber — Frame number of desired point cloud in the file

positive integer

Frame number of the desired point cloud in file, specified as a positive integer. Frame numbers are sequential.

frameTime — Frame time of desired point cloud in file

duration scalar

Frame time of the desired point cloud in the file, specified as a duration scalar in seconds. The first frame available at or after frameTime is given.

Output Arguments

ptCloud — Point cloud

pointCloud object

Point cloud, returned as a `pointCloud` object.

See Also

`velodyneFileReader` | `pcplayer` | `pointCloud` | `pcshow` | `reset` | `hasFrame`

External Websites

Velodyne Manuals

Introduced in R2018a

reset

Reset the `CurrentTime` property of `velodyneFileReader` object to the default value

Syntax

```
reset(veloReader)
```

Description

`reset(veloReader)` resets the `CurrentTime` property of `velodyneFileReader` to the default value. The default value is the `StartTime` property of `velodyneFileReader`.

Examples

Reset the `velodyneFileReader` object

Construct `velodyneFileReader` object.

```
veloReader = velodyneFileReader('lidarData_ConstructionRoad.pcap', 'PuckLITE');
```

Inspect the properties of the `velodyneFileReader` object to know the `CurrentTime`. The default value of `CurrentTime` is the value of `StartTime`.

```
veloReader
```

```
veloReader =
```

```
  velodyneFileReader with properties:
```

```
      FileName: 'B:\matlab\toolbox\vision\visiondata\lidarData_ConstructionRoad.pcap'
      DeviceModel: 'PuckLITE'
      CalibrationFile: 'B:\matlab\toolbox\shared\pointclouds\utilities\velodyneFileReaderConfigura
      NumberOfFrames: 1238
      Duration: 61.845 sec
      StartTime: 1145.1 sec
      EndTime: 1206.9 sec
      Timestamps: [1145.1 sec    1145.1 sec    1145.2 sec    ...    ]
      CurrentTime: 1145.1 sec
```

Use `readFrame` to read a pointcloud sequence from the object `veloReader`. Specify frame number corresponding to the pointcloud sequence as 1000.

```
ptCloud = readFrame(veloReader,1000);
```

Inspect the `CurrentTime` property of `velodyneFileReader` object. The value of `CurrentTime` is changed to 1195 sec with reference to the pointcloud sequence read.

```
veloReader.CurrentTime
```

```
ans = duration
      1195 sec
```

Reset the `CurrentTime` property of `velodyneFileReader` object.

```
reset(veloReader)
```

Inspect the `CurrentTime` property and verify that its value is reset to the default value.

```
veloReader.CurrentTime
```

```
ans = duration  
    1145.1 sec
```

Input Arguments

veloReader — Velodyne file reader

`velodyneFileReader` object

Velodyne file reader, specified as a `velodyneFileReader` object.

See Also

`velodyneFileReader` | `readFrame` | `hasFrame`

External Websites

Velodyne Manuals

Introduced in R2018a

changeFilePaths

Change file paths in ground truth data

Syntax

```
unresolvedPaths = changeFilePaths(gTruth,alternativePaths)
```

Description

`unresolvedPaths = changeFilePaths(gTruth,alternativePaths)` changes the file paths stored in a `groundTruth` object, `gTruth`, based on pairs of current paths and alternative paths, `alternativePaths`. If `gTruth` is a vector of `groundTruth` objects, the function changes the file paths across all objects. The function returns the unresolved paths in `unresolvedPaths`. An unresolved path is any current path in `alternativePaths` not found in `gTruth` or any alternative path in `alternativePaths` not found at the specified path location. In both cases, `unresolvedPaths` returns only the current paths.

Use this function to update the file paths of ground truth data that changes folder locations. You can change file paths for the ground truth data source and pixel label data.

Examples

Change File Paths in Ground Truth Data

Change the file paths to the data source and pixel label data in a `groundTruth` object.

Load a `groundTruth` object containing ground truth data into the workspace. The data source and pixel label data of the object contains file paths corresponding to an image sequence showing a building. MATLAB® displays a warning that the path to the data source cannot be found.

```
load('gTruthSeq.mat');
```

```
Warning: The data source points to a directory that cannot be found.
```

```
'C:\CFP\building'
```

```
Update the DataSource using changeFilePaths method.
```

Display the current path to the data source.

```
gTruth.DataSource
```

```
ans =
```

```
'C:\CFP\building'
```

Specify the current path to the data source and an alternative path and store these paths in a cell array. Use the `changeFilePaths` function to update the data source path based on the paths in the cell array. Because the function does not find the pixel label data at the specified new path, it returns the current unresolved paths.

```
currentPathDataSource = "C:\CFP\building";
```

```
newPathDataSource = fullfile(matlabroot,"toolbox\vision\visiondata\building");
```

```
alternativePaths = {[currentPathDataSource newPathDataSource]};
unresolvedPaths = changeFilePaths(gTruth,alternativePaths)
```

```
unresolvedPaths = 5×1 string
    "C:\CFP\building\PixelLabelData\Label_1.png"
    "C:\CFP\building\PixelLabelData\Label_2.png"
    "C:\CFP\building\PixelLabelData\Label_3.png"
    "C:\CFP\building\PixelLabelData\Label_4.png"
    "C:\CFP\building\PixelLabelData\Label_5.png"
```

Verify that the paths in the `groundTruth` object match the unresolved paths returned by the `changeFilePaths` function. The unresolved paths are stored in the `LabelData` property of the `groundTruth` object, in the `PixelLabelData` column.

```
gTruth.LabelData.PixelLabelData
```

```
ans = 5×1 cell
    {'C:\CFP\building\PixelLabelData\Label_1.png'}
    {'C:\CFP\building\PixelLabelData\Label_2.png'}
    {'C:\CFP\building\PixelLabelData\Label_3.png'}
    {'C:\CFP\building\PixelLabelData\Label_4.png'}
    {'C:\CFP\building\PixelLabelData\Label_5.png'}
```

Specify the current path and an alternative path for the pixel label files and change the file paths. The function updates the paths for all pixel labels. Because the function resolves all paths, it returns an empty array of unresolved paths.

```
currentPathPixels = "C:\CFP\building\PixelLabelData";
newPathPixels = fullfile(matlabroot,"toolbox\vision\visiondata\buildingPixelLabels");
alternativePaths = {[currentPathPixels newPathPixels]};
unresolvedPaths = changeFilePaths(gTruth,alternativePaths)
```

```
unresolvedPaths =
    0×0 empty string array
```

To view the new data source path, use the `gTruth.DataSource` command. To view the new pixel label data paths, use the `gTruth.LabelData.PixelLabelData` command.

Input Arguments

gTruth — Ground truth data

groundTruth object | array of groundTruth objects

Ground truth data, specified as a `groundTruth` object or array of `groundTruth` objects. You can export these objects from the **Ground Truth Labeler** app or create them programmatically.

alternativePaths — Alternative file paths

1-by-2 string vector | cell array of 1-by-2 string vectors

Alternative file paths, specified as a 1-by-2 string vector or cell array of 1-by-2 string vectors of the form $[p_{\text{current}} \ p_{\text{new}}]$.

- p_{current} is a current file path in `gTruth`. This file path can be from the data source or pixel label data of `gTruth`. Specify p_{current} using backslashes as the path separators.
- p_{new} is the new path to which you want to change p_{current} . Specify p_{new} using either forward slashes or backslashes as the path separators.

You can specify alternative paths to these files:

- Data source — This path is stored in the `DataSource` property of `gTruth`.
- Pixel label data — These paths are stored in the `PixelLabelData` column of the `LabelData` property of `gTruth`.

If `gTruth` is a vector of `groundTruth` objects, the function changes the file paths across all objects.

Example: `["C:\Pixels\PixelLabelData_1" "C:\Pixels\PixelLabelData_2"]` changes the path to the pixel label data folder. The function updates the path in all pixel label files stored in that folder.

Example: `{["C:\Pixels\PixelLabelData_1" "C:\Pixels\PixelLabelData_2"]; ["B:\Sources\video.mp4" "C:\Sources\video.mp4"]}` changes the path to the pixel label data folder and the drive letter in the path to the data source.

Output Arguments

unresolvedPaths — Unresolved file paths

string array

Unresolved file paths, returned as a string array. If the function cannot find either the current path or new path in the string vectors specified by `alternativePaths`, then it returns the unresolved current paths in `unresolvedPaths`.

If the function finds and resolves all file paths, then it returns `unresolvedPaths` as an empty string array.

See Also

`groundTruth` | `groundTruthDataSource`

Topics

“Share and Store Labeled Ground Truth Data”

“How Labeler Apps Store Exported Pixel Labels”

Introduced in R2018b

labelDefinitionCreator

Object for storing, modifying and creating label definitions table

Description

The `labelDefinitionCreator` object stores definitions of labels, sublabels, and attributes for labeling ground truth data. Use “Object Functions” on page 2-902 to add, remove, modify, or display label definitions. Using the `create` object function, you can create label definitions table from the `labelDefinitionCreator` object. You can use this label definitions table with the **Image Labeler**, and **Video Labeler** apps. To create a label definitions table for use with the **Ground Truth Labeler** app, use a `labelDefinitionCreatorMultisignal` object instead.

Creation

Syntax

```
ldc = labelDefinitionCreator
ldc = labelDefinitionCreator(labelDefs)
```

Description

`ldc = labelDefinitionCreator` creates an empty label definition creator object, `ldc`. Add label definitions by using “Object Functions” on page 2-902. The details of the stored labels, sublabels, and attributes can be inspected using the `info` object function.

`ldc = labelDefinitionCreator(labelDefs)` creates a label definition creator object `ldc` and stores definitions from the label definitions table `labelDefs`. Use “Object Functions” on page 2-902 to add new label definitions or modify the existing label definitions. The details of the stored labels, sublabels, and attributes can be inspected using the `info` object function.

Input Arguments

labelDefs — Label definitions

table

Label definitions, specified as a table with up to seven columns. The possible columns are *Name*, *Type*, *LabelColor*, *PixelLabelID*, *Group*, *Description*, and *Hierarchy*. This table specifies the definitions of labels, sublabels, and attributes for labeling ground truth data. For more details, see “LabelDefinitions” on page 2-0 .

Output Arguments

ldc — Label definition creator

`labelDefinitionCreator` object

Label definition creator, returned as a `labelDefinitionCreator` object that contains information about label definitions associated with ground truth data.

Object Functions

<code>addLabel</code>	Add label to label definition creator object
<code>addSublabel</code>	Add sublabel to label in label definition creator object
<code>addAttribute</code>	Add attributes to label or sublabel in label definition creator object
<code>removeLabel</code>	Remove label from label definition creator object
<code>removeSublabel</code>	Remove sublabel from label in label definition creator object
<code>removeAttribute</code>	Remove attribute from label or sublabel in label definition creator object
<code>editLabelGroup</code>	Modify a label group name
<code>editGroupName</code>	Change group name
<code>editLabelDescription</code>	Modify description of label or sublabel in label definition creator object
<code>editAttributeDescription</code>	Modify description of attribute in label definition creator object
<code>create</code>	Create label definitions table from the label definition creator object
<code>info</code>	Display information about a label, sublabel, or attribute stored in label definition creator object

Examples

Create Label Definition Creator Object and Add Label Definitions

Create an empty label definition creator object.

```
ldc = labelDefinitionCreator
```

```
ldc =
```

```
labelDefinitionCreator with 0 labels. Use the addLabel method to add a label.
```

Add a label with the name "Vehicle" and specify the type of label as a rectangle.

```
addLabel(ldc, 'Vehicle', labelType.Rectangle)
```

Add a sublabel with the name "Wheel" and an attribute with the name "Color" to the label "Vehicle" stored in `ldc`. Specify the type of sublabel as a rectangle and the attribute type as a string with value 'Red'.

```
addSublabel(ldc, 'Vehicle', 'Wheel', labelType.Rectangle)
addAttribute(ldc, 'Vehicle', 'Color', attributeType.String, 'Red')
```

Display the details of the label definition creator object.

```
ldc
```

```
ldc =
```

```
labelDefinitionCreator contains the following labels:
```

```
    Vehicle with 1 sublabels and 1 attributes.    (info)
```

For more details about attributes and sublabels, use the `info` method.

Create Label Definition Creator Object from Existing Label Definitions Table

Load an existing label definitions table into the workspace.

```
labelDefFile = fullfile(toolboxdir('vision'), 'visiondata', 'labelDefsWithAttributes.mat');
ld = load(labelDefFile)
```

```
ld =  
    struct with fields:  
        labelDefs: [4×4 table]
```

Create a label definition creator object from the label definitions table. Display the details of the label definition creator object.

```
ldc = labelDefinitionCreator(ld.labelDefs)
```

```
ldc =
```

labelDefinitionCreator contains the following labels:

```
    Vehicle with 0 sublabels and 3 attributes.    (info)  
    Pedestrian with 0 sublabels and 0 attributes. (info)  
    LaneMarker with 0 sublabels and 2 attributes. (info)  
    TrafficLight with 1 sublabels and 0 attributes. (info)
```

For more details about attributes and sublabels, use the `info` method.

See Also

Apps

[Image Labeler](#) | [Video Labeler](#)

Objects

[groundTruth](#) | [labelType](#) | [attributeType](#)

Introduced in R2018b

addLabel

Add label to label definition creator object

Syntax

```
addLabel(ldc, labelName, typeOfLabel)
addLabel( ____, Name, Value)
```

Description

`addLabel(ldc, labelName, typeOfLabel)` adds a label with the specified name and type to the label definition creator object `ldc`.

`addLabel(____, Name, Value)` specifies options using one or more name-value arguments in addition to the input arguments in the previous syntax.

Examples

Add Label Using Label Definition Creator

Create a `labelDefinitionCreator`.

```
ldc = labelDefinitionCreator;
```

Add a label named 'Car'.

```
addLabel(ldc, 'Car', labelType.Rectangle);
```

Inspect the label.

```
ldc
```

```
ldc =
labelDefinitionCreator contains the following labels:
```

```
    Car with 0 sublabels and 0 attributes and belongs to None group.    (info)
```

For more details about attributes and sublabels, use the `info` method.

Add another label named 'StopSign' in a group named 'TrafficSign'. Add a description.

```
addLabel(ldc, 'StopSign', 'Rectangle', 'Group', 'TrafficSign', 'Description', 'Bounding boxes for stop
```

Inspect the labels.

```
ldc
```

```
ldc =
labelDefinitionCreator contains the following labels:
```

```
    Car with 0 sublabels and 0 attributes and belongs to None group.    (info)
```

```
    StopSign with 0 sublabels and 0 attributes and belongs to TrafficSign group.    (info)
```

For more details about attributes and sublabels, use the `info` method.

Add Labels Related to Driving Scene to Label Definition Creator Object

Create an empty label definition creator object.

```
ldc = labelDefinitionCreator
```

```
ldc =
labelDefinitionCreator
```

Add label "Vehicle" to the label definition creator object. Specify the type of label as a rectangle.

```
addLabel(ldc, 'Vehicle', labelType.Rectangle)
```

Add label "StopSign" to the label definition creator object. Specify the type of label as a rectangle and add a description to the label.

```
addLabel(ldc, 'StopSign', labelType.Rectangle, 'Description', 'Bounding boxes for stop signs')
```

Display the details of the label definition creator object.

```
ldc
```

```
ldc =
labelDefinitionCreator contains the following labels:
```

```
    Vehicle with 0 sublabels and 0 attributes and belongs to None group.    (info)
    StopSign with 0 sublabels and 0 attributes and belongs to None group.  (info)
```

For more details about attributes and sublabels, use the `info` method.

Display information about the label "Vehicle" using the object function `info`.

```
info(ldc, 'Vehicle')
```

```
    Name: "Vehicle"
    Type: Rectangle
    LabelColor: {' '}
    Group: "None"
    Attributes: []
    Sublabels: []
    Description: ' '
```

Display information about the label "StopSign" using the object function `info`.

```
info(ldc, 'StopSign')
```

```
    Name: "StopSign"
    Type: Rectangle
    LabelColor: {' '}
    Group: "None"
    Attributes: []
    Sublabels: []
    Description: 'Bounding boxes for stop signs'
```

Input Arguments

ldc — Label definition creator

labelDefinitionCreator object

Label definition creator, specified as a labelDefinitionCreator object.

labelName — Label name

character vector | string scalar

Label name, specified as a character vector or string scalar that uniquely identifies the label to be added.

typeOfLabel — Type of label

labelType enumeration | character vector | string scalar

Type of label, specified as one of these values:

- labelType enumeration — You can use any of these labelType enumerators to specify the type of label: Rectangle, Line, PixelLabel, Scene, or Custom.

Example: `addLabel(ldc, 'Car', labelType.Rectangle);`

- Character vector or string scalar — This value must partially or fully match one of the labelType enumerators.

Example: `addLabel(ldc, 'Car', 'Rec');`

Name-Value Pair Arguments

Specify optional comma-separated pairs of Name, Value arguments. Name is the argument name and Value is the corresponding value. Name must appear inside quotes. You can specify several name and value pair arguments in any order as Name1, Value1, ..., NameN, ValueN.

Example: `addLabel(ldc, 'Car', labelType.Rectangle, 'Description', 'Type of Vehicle');`

Group — Group name

'None' (default) | character vector | string scalar

Group name, specified as a comma-separated pair consisting of 'Group' and a character vector or string scalar. Use this name-value pair to specify a name for a group of labels.

Description — Label description

' ' (default) | character vector | string scalar

Label description, specified as a comma-separated pair consisting of 'Description' and a character vector or string scalar. Use this name-value pair to describe the label.

See Also

Objects

labelDefinitionCreator | labelType

Functions

addSublabel | addAttribute | editLabelDescription | removeLabel

Introduced in R2018b

addSublabel

Add sublabel to label in label definition creator object

Syntax

```
addSublabel(ldc, labelName, sublabelName, typeOfSublabel)
addSublabel( ____, Name, Value)
```

Description

`addSublabel(ldc, labelName, sublabelName, typeOfSublabel)` adds a sublabel with the specified name and type to the indicated label. The sublabel is added under the hierarchy for the specified label in the label definition creator object `ldc`.

`addSublabel(____, Name, Value)` specifies options using one or more name-value arguments in addition to the input arguments in the previous syntax.

Examples

Add Sublabels to Labels in Label Definition Creator Object

Load an existing label definitions table into the workspace.

```
load('labelDefsTable.mat')
```

Create a label definition creator object from the label definitions table.

```
ldc = labelDefinitionCreator(labelDefs)
```

```
ldc =
labelDefinitionCreator contains the following labels:
```

```
    Car with 0 sublabels and 0 attributes and belongs to None group.    (info)
    TrafficLight with 0 sublabels and 0 attributes and belongs to None group.    (info)
```

For more details about attributes and sublabels, use the `info` method.

Add sublabel "Wheel" to the label "Car". Specify the label type for sublabel as a rectangle and add description to the sublabel.

```
addSublabel(ldc, 'Car', 'Wheel', labelType.Rectangle, 'Description', 'Bounding box for the wheel')
```

Add sublabels "RedLight" and "GreenLight" to the label "TrafficLight". Specify the label type for the sublabels as rectangle.

```
addSublabel(ldc, 'TrafficLight', 'RedLight', labelType.Rectangle)
addSublabel(ldc, 'TrafficLight', 'GreenLight', labelType.Rectangle)
```

Display the details of the label definition creator object.

```
ldc
```



```
ldc =
labelDefinitionCreator contains the following labels:

    Car with 1 sublabels and 0 attributes and belongs to None group.    (info)
    TrafficLight with 2 sublabels and 0 attributes and belongs to None group.    (info)
```

For more details about attributes and sublabels, use the `info` method.

Display information about the sublabels under the label "Car" using the `info` object function.

```
info(ldc, 'Car')

    Name: "Car"
    Type: Rectangle
    LabelColor: {''}
    Group: "None"
    Attributes: []
    Sublabels: "Wheel"
    Description: 'Bounding box for car'
```

Display information about the sublabels under the label "TrafficLight" using the `info` object function.

```
info(ldc, 'TrafficLight')

    Name: "TrafficLight"
    Type: Rectangle
    LabelColor: {''}
    Group: "None"
    Attributes: []
    Sublabels: ["RedLight" "GreenLight"]
    Description: 'Bounding boxes for traffic light'
```

Input Arguments

ldc — Label definition creator

labelDefinitionCreator object

Label definition creator, specified as a `labelDefinitionCreator` object.

labelName — Label name

character vector | string scalar

Label name, specified as a character vector or string scalar that uniquely identifies the label to which the sublabel is associated.

sublabelName — Sublabel name

character vector | string scalar

Sublabel name, specified as a character vector or string scalar that identifies the sublabel to be added.

typeOfSublabel — Type of sublabel

labelType enumeration | character vector | string scalar

Type of sublabel, specified as one of these values:

- `labelType` enumeration — The type of sublabel must be one of these `labelType` enumerators: `Rectangle` or `Line`.

Example: `addSublabel(ldc, 'Car', 'Wheel', labelType.Rectangle)`

- Character vector or string scalar — This value must partially or fully match one of these `labelType` enumerators: `Rectangle` or `Line`.

Example: `addSublabel(ldc, 'Car', 'Wheel', 'Rec')`

Note The `labelType` enumerators `PixelLabel`, `Scene`, and `Custom` are not supported as values for the type of sublabel in labeling apps.

Name-Value Pair Arguments

Specify optional comma-separated pairs of `Name`, `Value` arguments. `Name` is the argument name and `Value` is the corresponding value. `Name` must appear inside quotes. You can specify several name and value pair arguments in any order as `Name1, Value1, ..., NameN, ValueN`.

Example: `addSublabel(ldc, 'Car', 'Wheel', 'Rect', 'Description', 'Bounding box for Wheel');`

Description — Sublabel description

' ' (default) | character vector | string scalar

Sublabel description, specified as a comma-separated pair consisting of `'Description'` and a character vector or string scalar. Use this name-value pair to describe the sublabel.

See Also

Objects

`labelDefinitionCreator` | `labelType`

Functions

`addLabel` | `addAttribute` | `removeSublabel`

Introduced in R2018b

addAttribute

Add attributes to label or sublabel in label definition creator object

Syntax

```
addAttribute(ldc, labelName, attributeName, typeOfAttribute, attributeDefault)
addAttribute( ____, Name, Value)
```

Description

`addAttribute(ldc, labelName, attributeName, typeOfAttribute, attributeDefault)` adds an attribute with specified name and type to the indicated label or sublabel. The attribute is added under the hierarchy for the specified label or sublabel in the label definition creator object `ldc`.

`addAttribute(____, Name, Value)` specifies options using one or more name-value arguments in addition to the input arguments in the previous syntax.

Examples

Add Attributes to Label and Sublabel in Label Definition Creator Object

Load an existing label definitions table into the workspace.

```
load('sublabelDefsTable.mat')
```

Create a label definition creator object from the label definitions table.

```
ldc = labelDefinitionCreator(labelDefs)
```

```
ldc =
labelDefinitionCreator contains the following labels:
```

```
    Car with 1 sublabels and 0 attributes and belongs to None group.    (info)
    TrafficLight with 2 sublabels and 0 attributes and belongs to None group.    (info)
```

For more details about attributes and sublabels, use the `info` method.

Add attribute "Color" to the label "Car". Specify the attribute type as a string with value 'Red'.

```
addAttribute(ldc, 'Car', 'Color', attributeType.String, 'Red')
```

Display information about the sublabels under the label "TrafficLight".

```
info(ldc, 'TrafficLight')
    Name: "TrafficLight"
    Type: Rectangle
    LabelColor: {''}
    Group: "None"
    Attributes: []
```

```
    Sublabels: ["RedLight" "GreenLight"]
    Description: 'Bounding boxes for traffic light'
```

Add attribute "IsOn" to the label "TrafficLight/RedLight". Specify the attribute type as logical with value true.

```
addAttribute(ldc, 'TrafficLight/RedLight', 'IsOn', 'logical', true)
```

Display the details of the label definition creator object.

```
ldc
```

```
ldc =
labelDefinitionCreator contains the following labels:
```

```
    Car with 1 sublabels and 1 attributes and belongs to None group.    (info)
    TrafficLight with 2 sublabels and 0 attributes and belongs to None group.    (info)
```

For more details about attributes and sublabels, use the info method.

Display information about the attributes under the label "Car" using the info object function.

```
info(ldc, 'Car')
```

```
    Name: "Car"
    Type: Rectangle
    LabelColor: {' '}
    Group: "None"
    Attributes: "Color"
    Sublabels: "Light"
    Description: 'Bounding box for vehicle'
```

Display information about the attributes for sublabel "RedLight" under the label "TrafficLight" using the info object function.

```
info(ldc, 'TrafficLight/RedLight')
```

```
    Name: "RedLight"
    Type: Rectangle
    Attributes: "IsOn"
    Sublabels: []
    Description: ' '
```

Input Arguments

ldc — Label definition creator

labelDefinitionCreator object

Label definition creator, specified as a labelDefinitionCreator object.

labelName — Label or sublabel name

character vector | string scalar

Label or sublabel name, specified as a character vector or string scalar that uniquely identifies the label or sublabel to which the attribute is to be added.

- To specify a label, use the form `'labelName'`.
- To specify a sublabel, use the form `'labelName/sublabelName'`. In this case, the attribute associates to the sublabel.

attributeName — Attribute name

character vector | string scalar

Attribute name, specified as a character vector or string scalar that identifies the attribute to be added to the label or sublabel.

typeOfAttribute — Type of attribute

attributeType enumeration | character vector | string scalar

Type of attribute, specified as one of these values:

- attributeType enumeration — The type of attribute must be one of these enumerators in attributeType enumeration: `Numeric`, `Logical`, `String`, or `List`.

Example: `addAttribute(ldc, 'Car', 'Color', attributeType.String, 'Red');`

- Character vector or string scalar — This value must partially or fully match one of the enumerators in attributeType enumeration.

Example: `addAttribute(ldc, 'Car', 'Color', 'Str', 'Red');`

attributeDefault — Default value of attribute

numeric scalar | logical scalar | character vector | string scalar | cell array of character vectors | cell array of string scalars

Default value of the attribute, specified as one of these values:

- Numeric scalar — Specify this value when typeOfAttribute is `Numeric`.
- Logical scalar — Specify this value when typeOfAttribute is `Logical`.
- Character vector or string scalar — Specify this value when typeOfAttribute is `String`.
- Cell array of character vectors or cell array of string scalars — Specify this value when typeOfAttribute is `List`.

Name-Value Pair Arguments

Specify optional comma-separated pairs of `Name`, `Value` arguments. `Name` is the argument name and `Value` is the corresponding value. `Name` must appear inside quotes. You can specify several name and value pair arguments in any order as `Name1, Value1, ..., NameN, ValueN`.

Example: `addAttribute(ldc, 'Car/Wheel', 'Outsidediameter', attributeType.Numeric, 740, 'Description', 'Outside diameter in mm');`

Description — Attribute description

' ' (default) | character vector | string scalar

Attribute description, specified as a comma-separated pair consisting of `'Description'` and a character vector or string scalar. Use this name-value pair to describe the attribute.

See Also

Objects

labelDefinitionCreator | attributeType

Functions

addLabel | addSublabel | removeAttribute | editAttributeDescription

Introduced in R2018b

removeLabel

Remove label from label definition creator object

Syntax

```
removeLabel(ldc, labelName)
```

Description

`removeLabel(ldc, labelName)` removes the specified label from the label definition creator object `ldc`.

Note Removing a label also removes any attributes or sublabels associated with that label.

Examples

Remove Label from Label Definition Creator Object

Load an existing label definitions table into the workspace.

```
labelDefFile = fullfile(toolboxdir('vision'),'visiondata','labelDefsWithAttributes.mat');
ld = load(labelDefFile)

ld = struct with fields:
    labelDefs: [4x4 table]
```

Create a label definition creator object from the label definitions table.

```
ldc = labelDefinitionCreator(ld.labelDefs)
```

```
ldc =
labelDefinitionCreator contains the following labels:
```

```
    Vehicle with 0 sublabels and 3 attributes and belongs to None group.    (info)
    Pedestrian with 0 sublabels and 0 attributes and belongs to None group.  (info)
    LaneMarker with 0 sublabels and 2 attributes and belongs to None group.  (info)
    TrafficLight with 1 sublabels and 0 attributes and belongs to None group. (info)
```

For more details about attributes and sublabels, use the `info` method.

Remove the label "Vehicle" from the label definition creator object.

```
removeLabel(ldc, 'Vehicle')
```

Display the details of the label definition creator object to confirm that "Vehicle" is removed from the label definitions.

```
ldc
```

```
ldc =  
labelDefinitionCreator contains the following labels:  
  
    Pedestrian with 0 sublabels and 0 attributes and belongs to None group.    (info)  
    LaneMarker with 0 sublabels and 2 attributes and belongs to None group.    (info)  
    TrafficLight with 1 sublabels and 0 attributes and belongs to None group.  (info)
```

For more details about attributes and sublabels, use the `info` method.

Input Arguments

ldc — Label definition creator

labelDefinitionCreator object

Label definition creator, specified as a labelDefinitionCreator object.

labelName — Label name

character vector | string scalar

Label name, specified as a character vector or string scalar that uniquely identifies the label to be removed from the label definition creator object.

See Also

Objects

labelDefinitionCreator

Functions

addLabel | removeAttribute

Introduced in R2018b

removeSublabel

Remove sublabel from label in label definition creator object

Syntax

```
removeSublabel(ldc, labelName, sublabelName)
```

Description

`removeSublabel(ldc, labelName, sublabelName)` removes the specified sublabel from the indicated label. This label must be in the label definition creator object `ldc`.

Note Removing a sublabel also removes any attributes associated with that sublabel.

Examples

Remove Sublabel from Label in Label Definition Creator Object

Load an existing label definitions table into the workspace.

```
labelDefFile = fullfile(toolboxdir('vision'), 'visiondata', 'labelDefsWithAttributes.mat');
ld = load(labelDefFile)

ld = struct with fields:
    labelDefs: [4x4 table]
```

Create a label definition creator object from the label definitions table.

```
ldc = labelDefinitionCreator(ld.labelDefs)
```

```
ldc =
labelDefinitionCreator contains the following labels:
```

```
Vehicle with 0 sublabels and 3 attributes and belongs to None group.    (info)
Pedestrian with 0 sublabels and 0 attributes and belongs to None group.  (info)
LaneMarker with 0 sublabels and 2 attributes and belongs to None group. (info)
TrafficLight with 1 sublabels and 0 attributes and belongs to None group. (info)
```

For more details about attributes and sublabels, use the `info` method.

Display information about the label "TrafficLight" defined in the label definition creator object.

```
info(ldc, 'TrafficLight')

    Name: "TrafficLight"
    Type: Rectangle
LabelColor: {''}
    Group: "None"
Attributes: []
```

```
Sublabels: "Light"
Description: 'Mark a tight bounding box around the traffic light. Use the sublabels to mark e
```

Remove the sublabel "Light" from the label "TrafficLight".

```
removeSublabel(ldc, 'TrafficLight', 'Light')
```

Display the details of the label definition creator object to confirm that a sublabel is removed from the label "TrafficLight".

```
ldc
```

```
ldc =
labelDefinitionCreator contains the following labels:
```

```
Vehicle with 0 sublabels and 3 attributes and belongs to None group.    (info)
Pedestrian with 0 sublabels and 0 attributes and belongs to None group.  (info)
LaneMarker with 0 sublabels and 2 attributes and belongs to None group.  (info)
TrafficLight with 0 sublabels and 0 attributes and belongs to None group. (info)
```

For more details about attributes and sublabels, use the info method.

Display information about the label "TrafficLight". Confirm that the sublabel "Light" is removed.

```
info(ldc, 'TrafficLight')
```

```
    Name: "TrafficLight"
    Type: Rectangle
LabelColor: {''}
    Group: "None"
Attributes: []
Sublabels: []
Description: 'Mark a tight bounding box around the traffic light. Use the sublabels to mark e
```

Input Arguments

ldc — Label definition creator

labelDefinitionCreator object

Label definition creator, specified as a labelDefinitionCreator object.

labelName — Label name

character vector | string scalar

Label name, specified as a character vector or string scalar that uniquely identifies the label to which the sublabel is associated.

sublabelName — Sublabel name

character vector | string scalar

Sublabel name, specified as a character vector or string scalar that identifies the sublabel to be removed from the indicated label labelName.

See Also

Objects

labelDefinitionCreator

Functions

removeLabel | removeAttribute | addLabel | addSublabel

Introduced in R2018b

removeAttribute

Remove attribute from label or sublabel in label definition creator object

Syntax

```
removeAttribute(ldc, labelName, attributeName)
```

Description

`removeAttribute(ldc, labelName, attributeName)` removes the specified attribute from the indicated label or sublabel in the label definition creator object `ldc`.

Examples

Remove Attributes from Label and Sublabel in Label Definition Creator Object

Load an existing label definitions table into the workspace.

```
labelDefFile = fullfile(toolboxdir('vision'),'visiondata','labelDefsWithAttributes.mat');  
ld = load(labelDefFile)
```

```
ld = struct with fields:  
    labelDefs: [4x4 table]
```

Create a label definition creator object from the label definitions table.

```
ldc = labelDefinitionCreator(ld.labelDefs)
```

```
ldc =  
labelDefinitionCreator contains the following labels:
```

```
    Vehicle with 0 sublabels and 3 attributes and belongs to None group.    (info)  
    Pedestrian with 0 sublabels and 0 attributes and belongs to None group.  (info)  
    LaneMarker with 0 sublabels and 2 attributes and belongs to None group. (info)  
    TrafficLight with 1 sublabels and 0 attributes and belongs to None group. (info)
```

For more details about attributes and sublabels, use the `info` method.

Remove an Attribute from a Label

Display information about the label "Vehicle" defined in the label definition creator object.

```
info(ldc, 'Vehicle')
```

```
    Name: "Vehicle"  
    Type: Rectangle  
    LabelColor: {''}  
    Group: "None"  
    Attributes: ["Class"    "Color"    "View"]  
    Sublabels: []  
    Description: 'Draw a tight bounding box around the vehicle. Use this label for cars, buses and trucks.'
```

Remove the attribute "Color" from the label "Vehicle".

```
removeAttribute(ldc, 'Vehicle', 'Color')
```

Display information about the label "Vehicle". Confirm that the attribute "Color" is removed.

```
info(ldc, 'Vehicle')
```

```

    Name: "Vehicle"
    Type: Rectangle
    LabelColor: {' '}
    Group: "None"
    Attributes: ["Class" "View"]
    Sublabels: []
    Description: 'Draw a tight bounding box around the vehicle. Use this label for cars, buses and

```

Remove an Attribute from a Sublabel

Display information about the label "TrafficLight" defined in the label definition creator object.

```
info(ldc, 'TrafficLight')
```

```

    Name: "TrafficLight"
    Type: Rectangle
    LabelColor: {' '}
    Group: "None"
    Attributes: []
    Sublabels: "Light"
    Description: 'Mark a tight bounding box around the traffic light. Use the sublabels to mark

```

Display information about the sublabel "Light" under the label "TrafficLight".

```
info(ldc, 'TrafficLight/Light')
```

```

    Name: "Light"
    Type: Rectangle
    Attributes: ["Active" "Color"]
    Sublabels: []
    Description: 'Mark a tight bounding box around each light.'

```

Remove the attribute "Active" from the sublabel "TrafficLight/Light".

```
removeAttribute(ldc, 'TrafficLight/Light', 'Active')
```

Display information about the sublabel "TrafficLight/Light". Confirm that the attribute "Active" is removed.

```
info(ldc, 'TrafficLight/Light')
```

```

    Name: "Light"
    Type: Rectangle
    Attributes: "Color"
    Sublabels: []
    Description: 'Mark a tight bounding box around each light.'

```

Input Arguments

ldc — Label definition creator

labelDefinitionCreator object

Label definition creator, specified as a `labelDefinitionCreator` object.

labelName — Label or sublabel name

character vector | string scalar

Label or sublabel name, specified as a character vector or string scalar that uniquely identifies the label or sublabel from which the attribute is to be removed.

- To specify a label, use the form '*labelName*'.
- To specify a sublabel, use the form '*labelName/sublabelName*'. In this case, the attribute associates to the sublabel.

attributeName — Attribute name

character vector | string scalar

Attribute name, specified as a character vector or string scalar that identifies the attribute to be removed from the indicated label or sublabel `labelName`.

See Also**Objects**

`labelDefinitionCreator`

Functions

`removeLabel` | `addLabel` | `addAttribute`

Introduced in R2018b

editLabelDescription

Modify description of label or sublabel in label definition creator object

Syntax

```
editLabelDescription(ldc, labelName, description)
```

Description

`editLabelDescription(ldc, labelName, description)` modifies the description of a label or sublabel identified by `labelName`. The label or sublabel must be in the label definition creator object `ldc`.

Examples

Modify Description of Label and Sublabel in Label Definition Creator Object

Load an existing label definitions table into the workspace.

```
load('editLabelDefs.mat')
```

Create a label definition creator object from the label definitions table.

```
ldc = labelDefinitionCreator(labelDefs)
```

```
ldc =
```

```
labelDefinitionCreator contains the following labels:
```

```

    Vehicle with 0 sublabels and 3 attributes and belongs to None group.    (info)
    Pedestrian with 0 sublabels and 0 attributes and belongs to None group.  (info)
    LaneMarker with 0 sublabels and 2 attributes and belongs to None group.  (info)
    TrafficLight with 1 sublabels and 0 attributes and belongs to None group. (info)

```

For more details about attributes and sublabels, use the `info` method.

Modify the Description of a Label

Display information about the label "LaneMarker".

```
info(ldc, 'LaneMarker')
```

```

    Name: "LaneMarker"
    Type: Line
    LabelColor: {''}
    Group: "None"
    Attributes: ["BoundaryType"    "Location_wrt_Ego"]
    Sublabels: []
    Description: ''

```

Modify the description for the label "LaneMarker".

```
editLabelDescription(ldc, 'LaneMarker', 'Use 5 or more points for curved lane lines.')
```

Display information about the label "LaneMarker" to verify the modified label description.

```
info(ldc, 'LaneMarker')
    Name: "LaneMarker"
    Type: Line
    LabelColor: {''}
    Group: "None"
    Attributes: ["BoundaryType" "Location_wrt_Ego"]
    Sublabels: []
    Description: 'Use 5 or more points for curved lane lines.'
```

Modify the Description of a Sublabel

Display information about the label "TrafficLight".

```
info(ldc, 'TrafficLight')
    Name: "TrafficLight"
    Type: Rectangle
    LabelColor: {''}
    Group: "None"
    Attributes: []
    Sublabels: "Light"
    Description: 'Bounding box for the traffic light. Use sublabels to mark each individual light.'
```

Display information about the sublabel "Light" under the label "TrafficLight".

```
info(ldc, 'TrafficLight/Light')
    Name: "Light"
    Type: Rectangle
    Attributes: ["Active" "Color"]
    Sublabels: []
    Description: 'lights'
```

Modify the description for the sublabel "Light".

```
editLabelDescription(ldc, 'TrafficLight/Light', 'Mark a tight bounding box around each light.')
```

Display information about the sublabel "Light" to verify the modified sublabel description.

```
info(ldc, 'TrafficLight/Light')
    Name: "Light"
    Type: Rectangle
    Attributes: ["Active" "Color"]
    Sublabels: []
    Description: 'Mark a tight bounding box around each light.'
```

Input Arguments

ldc — Label definition creator

labelDefinitionCreator object

Label definition creator, specified as a labelDefinitionCreator object.

labelName — Label or sublabel name

character vector | string scalar

Label or sublabel name, specified as a character vector or string scalar that uniquely identifies the label or sublabel for which the description is to be updated.

- To specify a label, use the form *'labelName'*.
- To specify a sublabel, use the form *'labelName/sublabelName'*.

description – Description

character vector | string scalar

Description, specified as a character vector or string scalar that contains the new description for the label or sublabel identified by `labelName`.

See Also**Objects**

labelDefinitionCreator | groundTruth

Functions

editAttributeDescription

Introduced in R2018b

editLabelGroup

Modify a label group name

Syntax

```
editLabelGroup(ldc, labelName, groupName)
```

Description

`editLabelGroup(ldc, labelName, groupName)` modifies the group name that corresponds to the label identified by `labelName`. The label must be in the label definition creator object `ldc`.

Examples

Modify Group Name for Labels

Create a `labelDefinitionCreator`.

```
ldc = labelDefinitionCreator;
```

Add a rectangle label named `Car` in a group named `Vehicle`.

```
addLabel(ldc, 'Car', labelType.Rectangle, 'Group', 'Vehicle');
```

Add a rectangle label named `Truck` in a group named `FourWheeler`.

```
addLabel(ldc, 'Truck', labelType.Rectangle, 'Group', 'FourWheeler');
```

Move the `Car` label into the `FourWheeler` group.

```
editLabelGroup(ldc, 'Car', 'FourWheeler');
```

Inspect the labels.

```
ldc
```

```
ldc =
```

```
labelDefinitionCreator contains the following labels:
```

```
    Car with 0 sublabels and 0 attributes and belongs to FourWheeler group.    (info)
    Truck with 0 sublabels and 0 attributes and belongs to FourWheeler group. (info)
```

For more details about attributes and sublabels, use the `info` method.

Input Arguments

ldc — Label definition creator

`labelDefinitionCreator` object

Label definition creator, specified as a `labelDefinitionCreator` object.

labelName — Label name

character vector | string scalar

Label name, specified as a character vector or string scalar that uniquely identifies the label that corresponds to the `groupName` you want to modify.

groupName — Group name

character vector | string scalar

Group name, specified as a character vector or string scalar that identifies the group you want to modify, which corresponds to the label specified by `labelName`.

See Also**Objects**

labelDefinitionCreator

Functions

editLabelDescription | editGroupName

Introduced in R2019a

editGroupName

Change group name

Syntax

```
editGroupName(ldc,oldname,newname)
```

Description

`editGroupName(ldc,oldname,newname)` changes the group name from `oldname` to `newname`. This function changes the group name in all the label definitions that have the `oldname`.

Examples

Rename Label Group Created with `labelDefinitionCreator`

Create a `labelDefinitionCreator`.

```
ldc = labelDefinitionCreator;
```

Add labels named `Car` and `Truck` in a group named `Vehicle`.

```
addLabel(ldc,'Car',labelType.Rectangle,'Group','Vehicle');  
addLabel(ldc,'Truck',labelType.Rectangle,'Group','Vehicle');
```

Change the `Vehicle` group name `FourWheeler`.

```
editGroupName(ldc,'Vehicle','FourWheeler');
```

Inspect the labels.

```
ldc
```

```
ldc =  
labelDefinitionCreator contains the following labels:
```

```
    Car with 0 sublabels and 0 attributes and belongs to FourWheeler group.    (info)  
    Truck with 0 sublabels and 0 attributes and belongs to FourWheeler group. (info)
```

For more details about attributes and sublabels, use the `info` method.

Input Arguments

ldc — Label definition creator

`labelDefinitionCreator` object

Label definition creator, specified as a `labelDefinitionCreator` object.

oldname — Old group name

character vector | string scalar

Old group name, specified as a character vector or string scalar that uniquely identifies group name you want to modify.

newname — New group name

character vector | string scalar

New group name, specified as a character vector or string scalar that uniquely identifies the new group name.

See Also

Objects

labelDefinitionCreator

Functions

editLabelDescription | editLabelGroup

Introduced in R2019a

editAttributeDescription

Modify description of attribute in label definition creator object

Syntax

```
editAttributeDescription(ldc, labelName, attributeName, description)
```

Description

`editAttributeDescription(ldc, labelName, attributeName, description)` modifies the description of an attribute under the label or sublabel identified by `labelName`. The label or sublabel must be in the label definition creator object `ldc`.

Examples

Modify Description of Attributes in Label Definition Creator Object

Load an existing label definitions table into the workspace.

```
labelDefFile = fullfile(toolboxdir('vision'), 'visiondata', 'labelDefsWithAttributes.mat');  
ld = load(labelDefFile)
```

```
ld = struct with fields:  
    labelDefs: [4x4 table]
```

Create a label definition creator object from the label definitions table.

```
ldc = labelDefinitionCreator(ld.labelDefs)
```

```
ldc =  
labelDefinitionCreator contains the following labels:
```

```
    Vehicle with 0 sublabels and 3 attributes and belongs to None group.    (info)  
    Pedestrian with 0 sublabels and 0 attributes and belongs to None group. (info)  
    LaneMarker with 0 sublabels and 2 attributes and belongs to None group. (info)  
    TrafficLight with 1 sublabels and 0 attributes and belongs to None group. (info)
```

For more details about attributes and sublabels, use the `info` method.

Modify the Description of Attribute Under a Label

Display information about the label "Vehicle".

```
info(ldc, 'Vehicle')  
  
    Name: "Vehicle"  
    Type: Rectangle  
    LabelColor: {''}  
    Group: "None"  
    Attributes: ["Class"    "Color"    "View"]
```

```

    Sublabels: []
    Description: 'Draw a tight bounding box around the vehicle. Use this label for cars, buses and trucks.'

```

Display information about the attribute "Color" under the label "Vehicle".

```

info(ldc, 'Vehicle/Color')

    Name: "Color"
    Type: String
    DefaultValue: ""
    Description: 'Color of the vehicle, specified as a string, such as red, blue, white.'

```

Modify the description of the attribute "Color" under the label "Vehicle".

```

editAttributeDescription(ldc, 'Vehicle', 'Color', 'Color of the vehicle, specified as a string, e.g. "red".')

```

Display information about the label "Vehicle" to verify the modified attribute description.

```

info(ldc, 'Vehicle/Color')

    Name: "Color"
    Type: String
    DefaultValue: ""
    Description: 'Color of the vehicle, specified as a string, e.g. "red".'

```

Modify the Description of Attribute Under a Sublabel

Display information about the label "TrafficLight".

```

info(ldc, 'TrafficLight')

    Name: "TrafficLight"
    Type: Rectangle
    LabelColor: {' '}
    Group: "None"
    Attributes: []
    Sublabels: "Light"
    Description: 'Mark a tight bounding box around the traffic light. Use the sublabels to mark each light.'

```

Display information about the sublabel "Light" under the label "TrafficLight".

```

info(ldc, 'TrafficLight/Light')

    Name: "Light"
    Type: Rectangle
    Attributes: ["Active" "Color"]
    Sublabels: []
    Description: 'Mark a tight bounding box around each light.'

```

Display information about the attribute "Active" under the sublabel "TrafficLight/Light".

```

info(ldc, 'TrafficLight/Light/Active')

    Name: "Active"
    Type: Logical
    DefaultValue: 0
    Description: 'Mark true if this light is active and false if not.'

```

Modify the description of the attribute "Active" under the sublabel "TrafficLight/Light".

```
editAttributeDescription(ldc, 'TrafficLight/Light', 'Active', 'Is Active: true (DefaultValue: 1), f
```

Display information about the attribute "Active" to verify the modified attribute description.

```
info(ldc, 'TrafficLight/Light/Active')
```

```
        Name: "Active"  
        Type: Logical  
DefaultValue: 0  
Description: 'Is Active: true (DefaultValue: 1), false (DefaultValue: 0)'
```

Input Arguments

ldc — Label definition creator

labelDefinitionCreator object

Label definition creator, specified as a labelDefinitionCreator object.

labelName — Label or sublabel name

character vector | string scalar

Label or sublabel name, specified as a character vector or string scalar that uniquely identifies the label or sublabel to which the attribute is associated.

- To specify a label, use the form '*labelName*'.
- To specify a sublabel, use the form '*labelName/sublabelName*'. In this case, the attribute is associated with the sublabel.

attributeName — Attribute name

character vector | string scalar

Attribute name, specified as a character vector or string scalar that identifies the attribute for which the description is to be updated.

description — Description

character vector | string scalar

Description, specified as a character vector or string scalar that contains the new description for the attribute identified by `attributeName`.

See Also

Objects

labelDefinitionCreator

Functions

editLabelDescription

Introduced in R2018b

create

Create label definitions table from the label definition creator object

Syntax

```
labelDefs = create(ldc)
```

Description

`labelDefs = create(ldc)` creates a label definitions table, `labelDefs`, from the label definition creator object `ldc`. You can import the `labelDefs` table into the **Image Labeler** and **Video Labeler** apps to label ground truth data.

Examples

Create Label Definitions Table from Label Definition Creator Object

Create an empty label definition creator object.

```
ldc = labelDefinitionCreator
```

```
ldc =  
labelDefinitionCreator
```

Add a label "Vehicle" to the label definition creator object. Specify the type of label as a rectangle and add a description to the label.

```
addLabel(ldc, 'Vehicle', 'Rectangle', 'Description', 'Bounding box for the vehicle. Use this label for
```

Add an attribute "IsCar" to the label "Vehicle". Specify the type of attribute as logical with value `true` and add description to the attribute.

```
addAttribute(ldc, 'Vehicle', 'IsCar', 'logical', true, 'Description', 'Type of vehicle')
```

Add an attribute "IsBus" to the label "Vehicle". Specify the type of attribute as logical with value `false` and add description to the attribute.

```
addAttribute(ldc, 'Vehicle', 'IsBus', 'logical', false, 'Description', 'Type of vehicle')
```

Create a label definitions table from the definitions stored in the label definition creator object.

```
labelDefs = create(ldc)
```

```
labelDefs=1x6 table
```

Name	Type	LabelColor	Group	Description
{'Vehicle'}	Rectangle	{0x0 char}	{'None'}	{'Bounding box for the vehicle. Use th

Input Arguments

ldc — Label definition creator

labelDefinitionCreator object

Label definition creator, specified as a `labelDefinitionCreator` object. The object `ldc` defines the labels, sublabels, and attributes used for generating the label definitions table `labelDefs`.

Output Arguments

labelDefs — Label definitions

table

Label definitions, returned as a table with up to seven columns. The possible columns are *Name*, *Type*, *LabelColor*, *PixelLabelID*, *Group*, *Description*, and *Hierarchy*. This table specifies the definitions of labels, sublabels, and attributes for labeling ground truth data. For more details, see “LabelDefinitions” on page 2-0 .

See Also

Objects

labelDefinitionCreator

Functions

addLabel | addSublabel | addAttribute | info

Introduced in R2018b

info

Display information about a label, sublabel, or attribute stored in label definition creator object

Syntax

```
info(ldc,name)
infoStruct = info(ldc,name)
```

Description

`info(ldc,name)` displays information about the specified label, sublabel or attribute stored in the label definition creator object `ldc`.

`infoStruct = info(ldc,name)` returns the information as a structure.

Examples

Display Information About Definitions Stored in Label Definition Creator Object

Load an existing label definitions table into the workspace. Create a label definition creator object.

```
FilePath = fullfile(toolboxdir('vision'),'visiondata','labelDefsWithAttributes.mat');
Ld = load(FilePath);
ldc = labelDefinitionCreator(Ld.labelDefs)
```

```
ldc =
labelDefinitionCreator contains the following labels:
```

```
Vehicle with 0 sublabels and 3 attributes and belongs to None group.    (info)
Pedestrian with 0 sublabels and 0 attributes and belongs to None group.  (info)
LaneMarker with 0 sublabels and 2 attributes and belongs to None group. (info)
TrafficLight with 1 sublabels and 0 attributes and belongs to None group. (info)
```

For more details about attributes and sublabels, use the `info` method.

Get information about the label "TrafficLight" as a structured data.

```
trafficStruct = info(ldc,'TrafficLight')
```

```
trafficStruct = struct with fields:
```

```
    Name: "TrafficLight"
    Type: Rectangle
    LabelColor: {''}
    Group: "None"
    Attributes: []
    Sublabels: "Light"
    Description: 'Mark a tight bounding box around the traffic light. Use the sublabels to mark e
```

Get information about the sublabel "Light" under the label "TrafficLight" as a structured data.

```
lightStruct = info(ldc,'TrafficLight/Light')
```

```
lightStruct = struct with fields:
    Name: "Light"
    Type: Rectangle
    Attributes: ["Active" "Color"]
    Sublabels: []
    Description: 'Mark a tight bounding box around each light.'
```

Get information about the attribute "Color" under the sublabel "TrafficLight/Light" as a structured data.

```
colorStruct = info(ldc, 'TrafficLight/Light/Color')
colorStruct = struct with fields:
    Name: "Color"
    Type: List
    ListItems: {3x1 cell}
    Description: 'Specify the color of the light as one of Red, Yellow (amber) or Green.'
```

Display the ListItems field of the structure colorStruct.

```
colorStruct.ListItems
```

```
ans = 3x1 cell
    {'Red' }
    {'Yellow'}
    {'Green' }
```

Input Arguments

ldc — Label definition creator

labelDefinitionCreator object

Label definition creator, specified as a labelDefinitionCreator object.

name — Name of label, sublabel, or attribute

character vector | string scalar

Name of label, sublabel, or attribute in the ldc object, specified as a character vector or string scalar whose form depends on the type of name you specify.

- To specify a label, use the form '*labelName*'.
- To specify a sublabel, use the form '*labelName/sublabelName*'.
- To specify an attribute, use the form '*labelName/sublabelName/attributeName*'.

Output Arguments

infoStruct — Information structure

structure

Information structure, returned as a structure that contains the fields Name, Type, Attributes (when pertinent), Sublabels (when pertinent), and Description. If name specifies an attribute, then infoStruct also contains the fields DefaultValue and ListItems (for List attributes).

See Also

Objects

labelDefinitionCreator

Functions

addLabel | create

Introduced in R2018b

vision.DeployableVideoPlayer

Package: vision

Display video

Description

The `DeployableVideoPlayer` object displays video frames. This player is capable of displaying high definition video at high frame rates. This video player object supports C code generation.

Note Starting in R2016b, instead of using the `step` method to perform the operation defined by the System object, you can call the object with arguments, as if it were a function. For example, `y = step(obj,x)` and `y = obj(x)` perform equivalent operations.

Creation

Syntax

```
depVideoPlayer = vision.DeployableVideoPlayer  
depVideoPlayer = vision.DeployableVideoPlayer(Name,Value)
```

Description

`depVideoPlayer = vision.DeployableVideoPlayer` returns a video player `depVideoPlayer`, for displaying video frames. This object, unlike the `vision.VideoPlayer` object, can generate C code.

`depVideoPlayer = vision.DeployableVideoPlayer(Name,Value)` sets properties using one or more name-value pairs. Enclose each property name in quotes. For example, `depVideoPlayer = vision.DeployableVideoPlayer('Name','Caption title')`

Properties

Location — Bottom left corner of video window

[] (default) | two-element vector

Location of bottom left corner of video frame, specified as a two-element vector. The first and second elements are specified in pixels and represent the horizontal and vertical coordinates respectively. The coordinates [0 0] represent the bottom left corner of the screen. The default location depends on the screen resolution, and will result in a window positioned in the center of the screen.

Name — Video window title bar caption

'Deployable Video Player'

Video window title bar caption, specified as the comma-separated pair consisting of 'Name' and a character vector.

Size — Size of video display window

True size (1:1) (default) | Full-screen | Custom

Size of video display window, specified as the comma-separated pair consisting of 'Size' and Full-screen, True size (1:1) or Custom. When this property is set to Full-screen, use the Esc key to exit out of full-screen mode.

CustomSize — Custom size for video player window

[300 410] (default) | two-element vector

Custom size for video player window, specified as the comma-separated pair consisting of 'CustomSize' and a two-element vector. The first and second elements are specified in pixels and represent the horizontal and vertical components respectively. The video data will be resized to fit the window. This property applies when you set the Size property to Custom.

InputColorFormat — Color format of input signal

RGB (default) | 'YCbCr 4:2:2'

Color format of input signal, specified as the comma-separated pair consisting of 'InputColorFormat' and 'RGB' or 'YCbCr 4:2:2'. The number of columns in the Cb and Cr components must be half the number of columns in Y.

Usage**Syntax**

```
depVideoPlayer(videoFrame)
depVideoPlayer(videoFrame,Y,Cb,Cr)
```

Description

depVideoPlayer(videoFrame) displays one grayscale or truecolor RGB video frame in the video player.

depVideoPlayer(videoFrame,Y,Cb,Cr) displays one frame of YCbCr 4:2:2 video in the color components Y, Cb, and Cr when you set the InputColorFormat property to YCbCr 4:2:2. The number of columns in the Cb and Cr components must be half the number of columns in the Y component.

Input Arguments**videoFrame — Video frame**

truecolor | 2-D grayscale image

Video frame, specified as a truecolor or 2-D grayscale image.

Y, Cb, Cr — YCbCr color format

'YCbCr 4:2:2'

YCbCr color format, returned in the YCbCr 4:2:2 format.

Object Functions

To use an object function, specify the System object as the first input argument. For example, to release system resources of a System object named `obj`, use this syntax:

```
release(obj)
```

Specific to vision.DeployableVideoPlayer

`isOpen` Visible or hidden status for player

Common to All System Objects

`step` Run System object algorithm

`release` Release resources and allow changes to System object property values and input characteristics

`reset` Reset internal states of System object

Examples

Play a Video From a File

Create a video reader and a video player object to read and view a video file.

```
videoFReader = vision.VideoFileReader('atrium.mp4');  
depVideoPlayer = vision.DeployableVideoPlayer;
```

Continue to read frames of video until the last frame is read. Exit the loop if the user closes the video player window.

```
cont = ~isDone(videoFReader);  
while cont  
    videoFrame = videoFReader();  
    depVideoPlayer(videoFrame);  
    cont = ~isDone(videoFReader) && isOpen(depVideoPlayer);  
end
```

Release the System objects.

```
release(videoFReader);  
release(depVideoPlayer);
```

Extended Capabilities

C/C++ Code Generation

Generate C and C++ code using MATLAB® Coder™.

Usage notes and limitations:

- Generated code for this function uses a precompiled platform-specific shared library.
- See “System Objects in MATLAB Code Generation” (MATLAB Coder).

See Also

`vision.VideoFileWriter` | `vision.VideoFileReader` | `vision.VideoPlayer`

Introduced in R2012a

Simulink.ImageType

Specify image data type

Description

Use a `Simulink.ImageType` object to set and share image data types for signal, state, and parameter data in a model.

- 1 Create an instance of this class in the MATLAB base workspace.
- 2 Set the properties of the object to describe the image.
- 3 Assign the data type to supported blocks, which have a **Data type** parameter, that you want to conform to the data type.

The benefits of the `Simulink.ImageType` data type include:

- Strong typing of image data at model interfaces.
- Carrying image data attributes such as color format and pixel data type, eliminating the need to create and maintain secondary signals.
- Enabling the Simulink environment to interpret the data as an image.
- Enabling custom data type replacement with third party implementation, such as the OpenCV class `cv::Mat`.

Creation

To create a `Simulink.NumericType` object programmatically, use the `Simulink.NumericType` function described below.

Syntax

```
imageType = Simulink.ImageType
imageType = Simulink.ImageType(Rows,Columns,Channels)
imageType = Simulink.ImageType(Rows,Columns,Channels,'ClassUnderlying',
ClassUnderlying,'ColorFormat',ColorFormat,'Layout',Layout)
```

Description

`imageType = Simulink.ImageType` returns a `Simulink.Parameter` object with default property values.

`imageType = Simulink.ImageType(Rows,Columns,Channels)` returns a `Simulink.ImageType` object and initializes the `Rows`, `Columns`, and `Channels` property to the specified values.

`imageType = Simulink.ImageType(Rows,Columns,Channels,'ClassUnderlying',ClassUnderlying,'ColorFormat',ColorFormat,'Layout',Layout)` returns a `Simulink.ImageType` object and additionally initializes the optional properties `ClassUnderlying`, `ColorFormat`, and `Layout` to the specified values.

Properties

Rows — Number of rows in image data

480 (default) | positive integer

Number of rows in the image data, specified as a positive integer.

Example: 480

Data Types: double

Columns — Number of columns in image data

640 (default) | positive integer

Number of columns in the image data, specified as a positive integer.

Example: 640

Data Types: double

Channels — Number of color channels or samples for each pixel in array

3 (default) | 1

Number of color channels or samples for each pixel in the array, specified as 1 or 3. The number of channels must correspond to the number of color channels in the color format of the image data. These are the values of Channels for the supported color formats:

Color Format	Channels
Grayscale	1
RGB	3
BGR	3

Example: 3

Data Types: double

ClassUnderlying — Data type of underlying image data

'uint8' (default) | 'int8' | 'uint16' | 'int16' | 'uint32' | 'int32' | 'single' | 'double' | 'logical'

Data type of the underlying image data, specified as one of these values:

- 'uint8'
- 'int8'
- 'uint16'
- 'int16'
- 'uint32'
- 'int32'
- 'single'
- 'double'
- 'logical'

Example: 'uint8'

Data Types: char | string

ColorFormat — Color format of underlying image data

'RGB' (default) | 'Grayscale' | 'BGR'

Color format of the underlying image data, specified as 'RGB', 'Grayscale', or 'BGR'. The color format determines what each color channel of a pixel in the image represents.

Example: 'RGB'

Data Types: char | string

Layout — Memory arrangement of matrix data in image

'ColumnMajor' (default) | 'RowMajor'

Memory arrangement of the matrix data in the image, specified as 'ColumnMajor' or 'RowMajor'.

Example: 'ColumnMajor'

Data Types: char | string

Examples

Configure Data as Simulink.ImageType Data Type

- 1 Create a Simulink.ImageType object with default values.

```
imageType = Simulink.ImageType;
```

```
imageType =
```

```
ImageType with properties:
```

```
    Rows: 480
```

```
    Cols: 640
```

```
 Channels: 3
```

```
ClassUnderlying: 'uint8'
```

```
ColorFormat: 'RGB'
```

```
Layout: 'ColumnMajor'
```

- 2 Set the properties of the object to describe the image.

```
imageType.Rows = 720
```

```
imageType.Cols = 860
```

You can then reference this object from supported blocks that have a **Data type** field parameter.

Limitations

These blocks support simulation and code generation of a Simulink.ImageType object:

Block Library	Block Name
Sources	<ul style="list-style-type: none"> • Ground • Inport • Outport • From Multimedia File (Computer Vision Toolbox)
Signal Routing	<ul style="list-style-type: none"> • Goto • From • Data Store Read • Data Store Write • Data Store Memory • Switch • Multiport Switch • Merge • Variant Source • Variant Merge (internal block added during code generation) • Mux • Demux • Vector Concatenate, Matrix Concatenate • Selector
Sink	<ul style="list-style-type: none"> • Terminator • Video Viewer (Computer Vision Toolbox) (simulation only)
Ports & Subsystems	<ul style="list-style-type: none"> • Subsystem, Atomic Subsystem, CodeReuse Subsystem • Enabled Subsystem • Triggered Subsystem • Function-Call Subsystem • If • Switch Case • Resettable Subsystem • For Iterator Subsystem • Model
Discrete	<ul style="list-style-type: none"> • Unit Delay
Signal Attributes	<ul style="list-style-type: none"> • Signal Conversion • Signal Specification

Block Library	Block Name
User-Defined Functions	<ul style="list-style-type: none">• Initialize Function, Reset Function, and Terminate Function• Simulink Function block with side I/O and arguments

Extended Capabilities

C/C++ Code Generation

Generate C and C++ code using MATLAB® Coder™.

Usage notes and limitations:

- Supports C++ code generation. To generate code, set the **Language** model configuration parameter to C++ and the **Language standard** to C++11 (ISO).

See Also

[Image To Matrix](#) | [Matrix To Image](#)

Topics

[“Convert Between Simulink Image Type and Matrices”](#)

[“Smile Detection by Using OpenCV Code in Simulink”](#)

[“Convert RGB Image to Grayscale Image by Using OpenCV Importer”](#)

[“Shadow Detection by Using OpenCV Code in Simulink”](#)

Introduced in R2021b

Functions

folders2labels

Get list of labels from folder names

Syntax

```
lbls = folders2labels(loc)
lbls = folders2labels(loc,Name,Value)

lbls = folders2labels(ds)

[lbls,files] = folders2labels( ___ )
```

Description

Use this function when you are working on a machine or deep learning classification problem and your labeled data is stored in folders that have the corresponding label names.

`lbls = folders2labels(loc)` creates a list of labels based on the folder names specified by the location `loc`.

`lbls = folders2labels(loc,Name,Value)` specifies additional input arguments using name-value pairs. For example, 'FileExtensions', '.mat' includes only .mat files in the scan for labels.

`lbls = folders2labels(ds)` creates a list of labels based on the files contained in `ds`. `ds` can be a datastore, a `matlab.io.datastore.FileSet` object, or a `matlab.io.datastore.BlockedFileSet` object.

`[lbls,files] = folders2labels(___)` additionally returns a list of files. The *i*th element of `lbls` corresponds to the label of the *i*th file in `files`.

Examples

Labels from Folder Names

Create a folder called `Files` in the current folder containing three subfolders, `Files_1`, `Files_2`, and `Files_3`. Add to each subfolder a random number of files, each containing a random signal of random size.

```
mkdir Files

for kj = 1:3
    fname = "Files_" + kj;
    mkdir(fname)
    for jk = 1:randi(4)
        sname = "sig_" + kj + "_" + jk;
        sgn = randn(randi([30 50]),randi(2));
        save(sname,"sgn")
        movefile(sname + ".mat",fname)
    end
end
```



```

        movefile(fname, "Files")
end

```

List the contents of the folders.

```
dir("*/**/*")
```

```
Files Found in: Files\Files_1
```

```

.          sig_1_1.mat  sig_1_3.mat
..         sig_1_2.mat  sig_1_4.mat

```

```
Files Found in: Files\Files_2
```

```

.          ..          sig_2_1.mat  sig_2_2.mat

```

```
Files Found in: Files\Files_3
```

```

.          ..          sig_3_1.mat  sig_3_2.mat  sig_3_3.mat

```

Create a list of labels based on the folder names.

```
lbls = folders2labels("Files")
```

```
lbls = 9x1 categorical
```

```

Files_1
Files_1
Files_1
Files_1
Files_2
Files_2
Files_3
Files_3
Files_3

```

List the names of the files associated with the labels.

```

[~,files] = folders2labels("Files");
[~,fnames] = fileparts(files)

```

```
fnames = 9x1 string
```

```

"sig_1_1"
"sig_1_2"
"sig_1_3"
"sig_1_4"
"sig_2_1"
"sig_2_2"
"sig_3_1"
"sig_3_2"
"sig_3_3"

```

Remove the Files directory you created at the beginning of the example.

```
rmdir Files s
```

Input Arguments

loc — Files or folders to scan for labels

character vector | cell array of character vectors | string scalar | string array

Files or folders to scan for labels, specified as a character vector, a cell array of character vectors, a string scalar, or a string array, containing the location of files or folders that are local or remote.

- Local files or folders — Specify `loc` as a local path to files or folders. If the files are not in the current folder, then the local path must specify full or relative paths. Files within subfolders of the specified folder are included by default. You can use the wildcard character (*) when specifying the local path. This character specifies that the file search include all matching files or all files in the matching folders.
- A remote location specified using an internationalized resource identifier (IRI).
- Remote files or folders — Specify `loc` to be the full paths of the files or folders as a uniform resource locator (URL) of the form `hdfs:///path_to_file`. For more information, see “Work with Remote Data”.

`folders2labels` looks for all file formats. To specify a custom list of file extensions to scan, use the `FileExtensions` argument.

Example: `'whale.mat'`

Example: `'../dir/data/signal.mat'`

Example: `"../dir/data/"`

Example: `{'dataFiles/Files_1/' 'dataFiles/Files_2/'}`

Example: `["dataFiles/Files_1/" "dataFiles/Files_2/"]`

Data Types: `char` | `string` | `cell`

ds — Data repository

`datastore` | `matlab.io.datastore.FileSet` object | `matlab.io.datastore.BlockedFileSet` object

Data repository, specified as a `datastore`, a `matlab.io.datastore.FileSet` object, or a `matlab.io.datastore.BlockedFileSet` object.

- If `ds` is a `datastore`, it must contain a `Files` property from which label names are parsed.
- If `ds` is a `matlab.io.datastore.FileSet` object, `folders2labels` obtains the label names from the file names listed in the `FileInfo` property of `ds`.
- If `ds` is a `matlab.io.datastore.BlockedFileSet` object, `folders2labels` obtains the label names from the file names listed in the `BlockInfo` property of `ds`.

Name-Value Pair Arguments

Specify optional comma-separated pairs of `Name`, `Value` arguments. `Name` is the argument name and `Value` is the corresponding value. `Name` must appear inside quotes. You can specify several name and value pair arguments in any order as `Name1, Value1, ..., NameN, ValueN`.

Example: `folders2labels('C:\dir\signaldata', 'FileExtensions', '.csv')` specifies a local path and includes only CSV files in the scan for labels.

IncludeSubfolders – Subfolder inclusion flag

false or 0 (default) | true or 1

Subfolder inclusion flag, specified as `true` or `false`. Specify `true` to include all files and subfolders within each folder or `false` to include only the files within each folder.

Example: `'IncludeSubfolders', true`

Data Types: `logical` | `double`

FileExtensions – Signal file extensions

character vector | cell array of character vectors | string scalar | string array

Signal file extensions, specified as a string scalar, string array, character vector, or cell array of character vectors.

Example: `'FileExtensions', '.csv'`

Data Types: `string` | `char` | `cell`

Output Arguments**lbls – List of labels**

categorical vector

List of labels, returned as a categorical vector.

files – List of files

string vector

List of files, returned as a string vector. The *i*th element of `lbls` corresponds to a label for the *i*th file in `files`.

See Also

`labeledSignalSet` | `signalLabelDefinition` | `countLabels` | `splitLabels`

Introduced in R2021a

splitlabels

Find indices to split labels according to specified proportions

Syntax

```
idxs = splitlabels(lblsrc,p)
idxs = splitlabels(lblsrc,p,'randomized')
idxs = splitlabels( ___,Name,Value)
```

Description

Use this function when you are working on a machine or deep learning classification problem and you want to split a dataset into training, testing, and validation sets that hold the same proportion of label values.

`idxs = splitlabels(lblsrc,p)` finds logical indices that split the labels in `lblsrc` based on the proportions or number of labels specified in `p`.

`idxs = splitlabels(lblsrc,p,'randomized')` randomly assigns the specified proportion of label values to each index set in `idxs`.

`idxs = splitlabels(___,Name,Value)` specifies additional input arguments using name-value pairs. For example, `'UnderlyingDatastoreIndex',3` splits the labels only in the third underlying datastore of a combined datastore.

Examples

Split Vowels

Read William Shakespeare's sonnets with the `fileread` function. Extract all the vowels from the text and convert them to lowercase.

```
sonnets = fileread("sonnets.txt");
vowels = lower(sonnets(regex(sonnets,"[AEIOUaeiou]")));
```

Count the number of instances of each vowel.

```
cnts = countlabels(vowels)
```

```
cnts=5x3 table
   Label   Count   Percent
   _____
   a       4940    18.368
   e       9028    33.569
   i       4895    18.201
   o       5710    21.232
   u       2321     8.6302
```

Split the vowels into a training set containing 500 instances of each vowel, a validation set containing 300, and a testing set with the rest. All vowels are represented with equal weights in the first two sets but not in the third.

```
spltn = splitlabels(vowels,[500 300]);

for kj = 1:length(spltn)
    cntsn{kj} = countlabels(vowels(spltn{kj}));
end
cntsn{:}
```

```
ans=5x3 table
  Label    Count    Percent
  _____  _____  _____
      a         500         20
      e         500         20
      i         500         20
      o         500         20
      u         500         20
```

```
ans=5x3 table
  Label    Count    Percent
  _____  _____  _____
      a         300         20
      e         300         20
      i         300         20
      o         300         20
      u         300         20
```

```
ans=5x3 table
  Label    Count    Percent
  _____  _____  _____
      a         4140        18.083
      e         8228        35.94
      i         4095        17.887
      o         4910        21.447
      u         1521         6.6437
```

Split the vowels into a training set containing 50% of the instances, a validation set containing another 30%, and a testing set with the rest. All vowels are represented with the same weight across all three sets.

```
spltp = splitlabels(vowels,[0.5 0.3]);

for kj = 1:length(spltp)
    cntsp{kj} = countlabels(vowels(spltp{kj}));
end
cntsp{:}
```

```
ans=5x3 table
  Label    Count    Percent
  _____  _____  _____
```

```

a      2470    18.367
e      4514    33.566
i      2448    18.203
o      2855     21.23
u      1161     8.6333

```

```

ans=5x3 table
Label      Count      Percent
-----
a          1482     18.371
e          2708     33.569
i          1468     18.198
o          1713     21.235
u           696     8.6277

```

```

ans=5x3 table
Label      Count      Percent
-----
a           988     18.368
e          1806     33.575
i           979      18.2
o          1142     21.231
u           464     8.6261

```

Split Vowels and Consonants

Read William Shakespeare's sonnets with the `file` read function. Remove all nonalphabetic characters from the text and convert to lowercase.

```

sonnets = fileread("sonnets.txt");
letters = lower(sonnets(regex(sonnets, "[A-z]")));

```

Classify the letters as consonants or vowels and create a table with the results. Show the first few rows of the table.

```

type = repmat("consonant",size(letters));
type(regex(letters, "[aeiou]")) = "vowel";

T = table(letters,type,'VariableNames',["Letter" "Type"]);
head(T)

```

```

ans=8x2 table
Letter      Type
-----
t          "consonant"
h          "consonant"
e          "vowel"
s          "consonant"
o          "vowel"

```

```

n      "consonant"
n      "consonant"
e      "vowel"

```

Display the number of instances of each category.

```
cnt = countlabels(T, 'TableVariable', "Type")
```

```
cnt=2x3 table
  Type      Count      Percent
-----
consonant  46516      63.365
vowel     26894      36.635
```

Split the table into two sets, one containing 60% of the consonants and vowels and the other containing 40%. Display the number of instances of each category.

```
splt = splitlabels(T,0.6, 'TableVariable', "Type");
```

```
sixty = countlabels(T(splt{1},:), 'TableVariable', "Type")
```

```
sixty=2x3 table
  Type      Count      Percent
-----
consonant  27910      63.366
vowel     16136      36.634
```

```
forty = countlabels(T(splt{2},:), 'TableVariable', "Type")
```

```
forty=2x3 table
  Type      Count      Percent
-----
consonant  18606      63.363
vowel     10758      36.637
```

Split the table into two sets, one containing 60% of each particular letter and the other containing 40%. Exclude the letter y, which sometimes acts as a consonant and sometimes as a vowel. Display the number of instances of each category.

```
splt = splitlabels(T,0.6, 'Exclude', "y");
```

```
sixti = countlabels(T(splt{1},:), 'TableVariable', "Type")
```

```
sixti=2x3 table
  Type      Count      Percent
-----
consonant  26719      62.346
vowel     16137      37.654
```

```
forti = countlabels(T(splt{2},:), 'TableVariable', "Type")
```

```
forti=2x3 table
  Type      Count      Percent
  -----
consonant   17813     62.349
vowel      10757     37.651
```

Split the table into two sets of the same size. Include only the letters *e* and *s*. Randomize the sets.

```
halves = splitlabels(T,0.5,'randomized','Include',["e" "s"]);
cnt = countlabels(T(halves{1},:))
```

```
cnt=2x3 table
  Letter    Count    Percent
  -----
     e      4514     64.385
     s      2497     35.615
```

Split Data in Datastore

Create a dataset that consists of 100 Gaussian random numbers. Label 40 of the numbers as A, 30 as B, and 30 as C. Store the data in a combined datastore containing two datastores. The first datastore has the data and the second datastore contains the labels.

```
dsData = arrayDatastore(randn(100,1));
dsLabels = arrayDatastore([repmat("A",40,1); repmat("B",30,1); repmat("C",30,1)]);
dsDataset = combine(dsData,dsLabels);
cnt = countlabels(dsDataset,'UnderlyingDatastoreIndex',2)
```

```
cnt=3x3 table
  Label    Count    Percent
  -----
     A      40      40
     B      30      30
     C      30      30
```

Split the data set into two sets, one containing 60% of the numbers and the other with the rest.

```
splitIndices = splitlabels(dsDataset,0.6,'UnderlyingDatastoreIndex',2);
dsDataset1 = subset(dsDataset,splitIndices{1});
cnt1 = countlabels(dsDataset1,'UnderlyingDatastoreIndex',2)
```

```
cnt1=3x3 table
  Label    Count    Percent
  -----
     A      24      40
     B      18      30
```



```
C      18      30
```

```
dsDataset2 = subset(dsDataset,splitIndices{2});
cnt2 = countlabels(dsDataset2,'UnderlyingDatastoreIndex',2)
```

```
cnt2=3x3 table
  Label    Count    Percent
  -----
  A         16         40
  B         12         30
  C         12         30
```

Input Arguments

lblsrc — Input label source

categorical vector | string vector | logical vector | numeric vector | cell array | table | datastore | CombinedDatastore object

Input label source, specified as one of these:

- A categorical vector.
- A string vector or a cell array of character vectors.
- A numeric vector or a cell array of numeric scalars.
- A logical vector or a cell array of logical scalars.
- A table with variables containing any of the previous data types.
- A datastore whose `readall` function returns any of the previous data types.
- A `CombinedDatastore` object containing an underlying datastore whose `readall` function returns any of the previous data types. In this case, you must specify the index of the underlying datastore that has the label values.

`lblsrc` must contain labels that can be converted to a vector with a discrete set of categories.

Example: `lblsrc = categorical(["B" "C" "A" "E" "B" "A" "A" "B" "C" "A"],["A" "B" "C" "D"])` creates the label source as a ten-sample categorical vector with four categories: A, B, C, and D.

Example: `lblsrc = [0 7 2 5 11 17 15 7 7 11]` creates the label source as a ten-sample numeric vector.

Data Types: `single` | `double` | `int8` | `int16` | `int32` | `int64` | `uint8` | `uint16` | `uint32` | `uint64` | `logical` | `char` | `string` | `table` | `cell` | `categorical`

p — Proportions or numbers of labels

integer scalar | scalar in (0, 1) | vector of integers | vector of fractions

Proportions or numbers of labels, specified as an integer scalar, a scalar in the range (0, 1), a vector of integers, or a vector of fractions.

- If `p` is a scalar, `splitlabels` finds two splitting index sets and returns a two-element cell array in `idxs`.

- If `p` is an integer, the first element of `idxs` contains a vector of indices pointing to the first `p` values of each label category. The second element of `idxs` contains indices pointing to the remaining values of each label category.
- If `p` is a value in the range (0, 1) and `lblsrc` has K_i elements in the i th category, the first element of `idxs` contains a vector of indices pointing to the first $p \times K_i$ values of each label category. The second element of `idxs` contains the indices of the remaining values of each label category.
- If `p` is a vector with N elements of the form p_1, p_2, \dots, p_N , `splitlabels` finds $N + 1$ splitting index sets and returns an $(N + 1)$ -element cell array in `idxs`.
- If `p` is a vector of integers, the first element of `idxs` is a vector of indices pointing to the first p_1 values of each label category, the next element of `idxs` contains the next p_2 values of each label category, and so on. The last element in `idxs` contains the remaining indices of each label category.
- If `p` is a vector of fractions and `lblsrc` has K_i elements of the i th category, the first element of `idxs` is a vector of indices concatenating the first $p_1 \times K_i$ values of each category, the next element of `idxs` contains the next $p_2 \times K_i$ values of each label category, and so on. The last element in `idxs` contains the remaining indices of each label category.

Note

- If `p` contains fractions, then the sum of its elements must not be greater than one.
 - If `p` contains numbers of label values, then the sum of its elements must not be greater than the smallest number of labels available for any of the label categories.
-

Data Types: `single` | `double` | `int8` | `int16` | `int32` | `int64` | `uint8` | `uint16` | `uint32` | `uint64`

Name-Value Pair Arguments

Specify optional comma-separated pairs of `Name`, `Value` arguments. `Name` is the argument name and `Value` is the corresponding value. `Name` must appear inside quotes. You can specify several name and value pair arguments in any order as `Name1, Value1, . . . , NameN, ValueN`.

Example: `'TableVariable', "AreaCode", 'Exclude', ["617" "508"]` specifies that the function split labels based on telephone area code and exclude numbers from Boston and Natick.

Include — Labels to include in index sets

vector of label categories | cell array of label categories

Labels to include in the index sets, specified as a vector or cell array of label categories. The categories specified with this argument must be of the same type as the labels in `lblsrc`. Each category in the vector or cell array must match one of the label categories in `lblsrc`.

Exclude — Labels to exclude from index sets

vector of label categories | cell array of label categories

Labels to exclude from the index sets, specified as a vector or cell array of label categories. The categories specified with this argument must be of the same type as the labels in `lblsrc`. Each category in the vector or cell array must match one of the label categories in `lblsrc`.

TableVariable — Table variable to read

first table variable (default) | character vector | string scalar

Table variable to read, specified as a character vector or string scalar. If this argument is not specified, then `splitlabels` uses the first table variable.

UnderlyingDatastoreIndex — Underlying datastore index

integer scalar

Underlying datastore index, specified as an integer scalar. This argument applies when `lblsrc` is a `CombinedDatastore` object. `splitlabels` counts the labels in the datastore obtained using the `UnderlyingDatastores` property of `lblsrc`.

Output Arguments**idxs — Splitting indices**

cell array

Splitting indices, returned as a cell array.

See Also`countlabels` | `folders2labels`**Introduced in R2021a**

generateCircleGridPoints

Generate circle grid point locations

Syntax

```
worldPoints = generateCircleGridPoints(patternDims,centerDistance)
[worldPoints] = generateCircleGridPoints( ____,PatternType="symmetry")
```

Description

`worldPoints = generateCircleGridPoints(patternDims,centerDistance)` generates circle grid point locations based on the specified number of circles in each dimension `patternDims` and the specified distance in world units between the centers of two adjacent circles `centerDistance`.

For more details on circle grid patterns, see “Circle Grid Patterns”.

`[worldPoints] = generateCircleGridPoints(____,PatternType="symmetry")` specifies the type of circle grid for which the function generates point locations. Specify `PatternType` as "asymmetric" or "symmetric". By default, the function generates point locations for an asymmetric circle grid.

Examples

Generate Point Locations for Asymmetric Circle Grid

Specify the distance between the centers of adjacent circles, in millimeters (mm). By default, the function generates point locations for an asymmetric circle grid.

```
centerDistance = 9;
worldPoints = generateCircleGridPoints([4 11],centerDistance);
```

Generate Point Locations for Symmetric Circle Grid

Specify the distance between the centers, in millimeters (mm). Set the pattern type to "symmetric".

```
centerDistance = 19;
worldPoints = generateCircleGridPoints([8 11],centerDistance, ...
                                       PatternType="symmetric");
```

Input Arguments

patternDims — Pattern dimensions

1-by-2 vector

Pattern dimensions, specified as a 1-by-2 vector that represents the number of circles in each dimension. For the asymmetric pattern, Dimension 1 corresponds to the number of circles in each

column. Dimension 2 corresponds to the total number of circles in the first two adjacent rows. For more details on circle grid patterns, see “Circle Grid Patterns”.

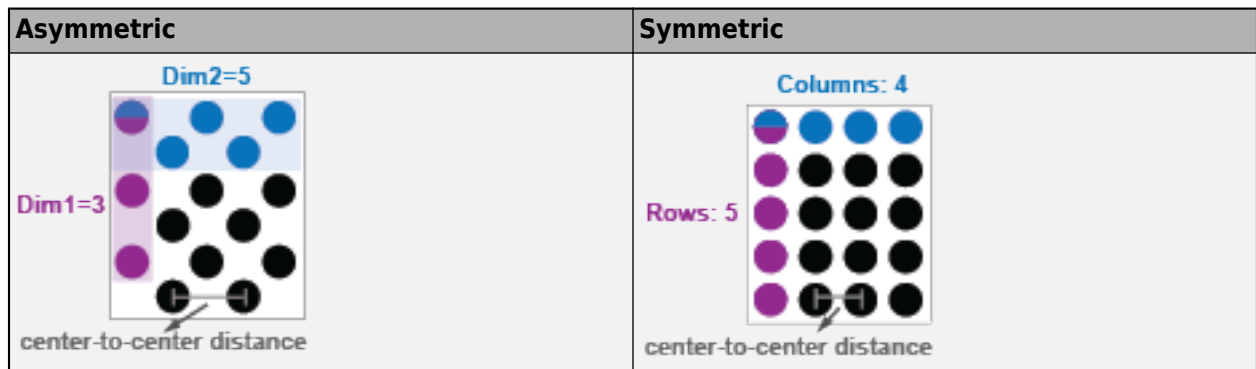

centerDistance — Distance between centers of two adjacent circles

scalar

Distance between centers of two adjacent circles in the same row or column, specified as a scalar in world units, such as millimeters.

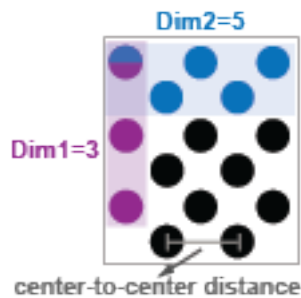

Output Arguments

worldPoints — Circle grid center locations

M-by-2 matrix

Circle grid center locations, returned as an *M*-by-2 matrix. Each row of the matrix specifies the *xy*-coordinates of a circle center relative to the origin. The origin (0,0) is the center of the top-left circle in the grid. *M* is the total number of circles in the grid, calculated as the product of the circle count in each dimension: `prod(patternDims)`.

See Also

Apps

Camera Calibrator | Stereo Camera Calibrator

Functions

detectCircleGridPoints | estimateCameraParameters | generateCheckerboardPoints

Topics

“Camera Calibration Using AprilTag Markers”

Introduced in R2021b

detectCircleGridPoints

Detect circle grid pattern in images

Syntax

```
imagePoints = detectCircleGridPoints(I,patternDims)
[imagePoints,imagesUsed] = detectCircleGridPoints(imageFileNames,patternDims)
[ ___ ] = detectCircleGridPoints(images,patternDims)

[imagePoints,pairsUsed] = detectCircleGridPoints(imageFileNames1,
imageFileNames2,patternDims)
[ ___ ] = detectCircleGridPoints(images1,images2,patternDims)

[ ___ ] = detectCircleGridPoints( ___ ,Name=Value)
```

Description

Single Image Circle Grid Detection

`imagePoints = detectCircleGridPoints(I,patternDims)` detects a circle grid in a 2-D truecolor or grayscale image, I. For more details on circle grid patterns, see "Circle Grid Patterns".

`[imagePoints,imagesUsed] = detectCircleGridPoints(imageFileNames,patternDims)` detects a circle grid in the image files specified by `imageFileNames`, and additionally returns the list of images in which the circle grid is detected `imagesUsed`.

`[___] = detectCircleGridPoints(images,patternDims)` detects a circle grid in the specified images `images`.

Stereo Pair Circle Grid Detection

`[imagePoints,pairsUsed] = detectCircleGridPoints(imageFileNames1, imageFileNames2,patternDims)` detects a circle grid in the stereo pairs of image files specified by `imageFileNames1` and `imageFileNames2`. The function additionally returns a list of the pairs in which the pattern is detected `pairsUsed`.

`[___] = detectCircleGridPoints(images1,images2,patternDims)` detects a circle grid in the stereo pairs of image files specified by `images1` and `images2`.

Optional Arguments

`[___] = detectCircleGridPoints(___ ,Name=Value)` specifies options using one or more name-value arguments in addition to any combination of arguments from previous syntaxes. For example, `detectCircleGridPoints(I,patternDims,PatternType="symmetric")` detects a symmetric circle grid in the specified workspace.

Examples

Detect Symmetric Circle Grid in Image

Load an image containing a circle grid pattern into the workspace.

```
imageFileName = fullfile(toolboxdir('vision'),'visiondata', ...  
    'calibration','circleGrid','mono','image08.jpg');  
I = imread(imageFileName);
```

Define the dimensions for the circle grid pattern.

```
patternDims = [8 11];
```

Detect the circle grid points.

```
imagePoints = detectCircleGridPoints(I,patternDims,PatternType="symmetric")
```

```
imagePoints = 88x2
```

```
    395.1729    358.4451  
    383.5573    388.4410  
    370.8857    420.9698  
    356.9887    456.5418  
    341.6686    495.7388  
    325.0617    538.9151  
    306.5055    586.8763  
    285.8323    640.1285  
    436.4195    363.5016  
    426.5806    393.4896  
      :
```

Display the detected points on the image.

```
J = insertText(I,imagePoints,1:size(imagePoints,1));  
J = insertMarker(J,imagePoints,'x',Color="green",Size=5);  
imshow(J)  
title("Detected a Circle Grid of Dimensions " + mat2str(patternDims))
```

Detected a Circle Grid of Dimensions [8 11]

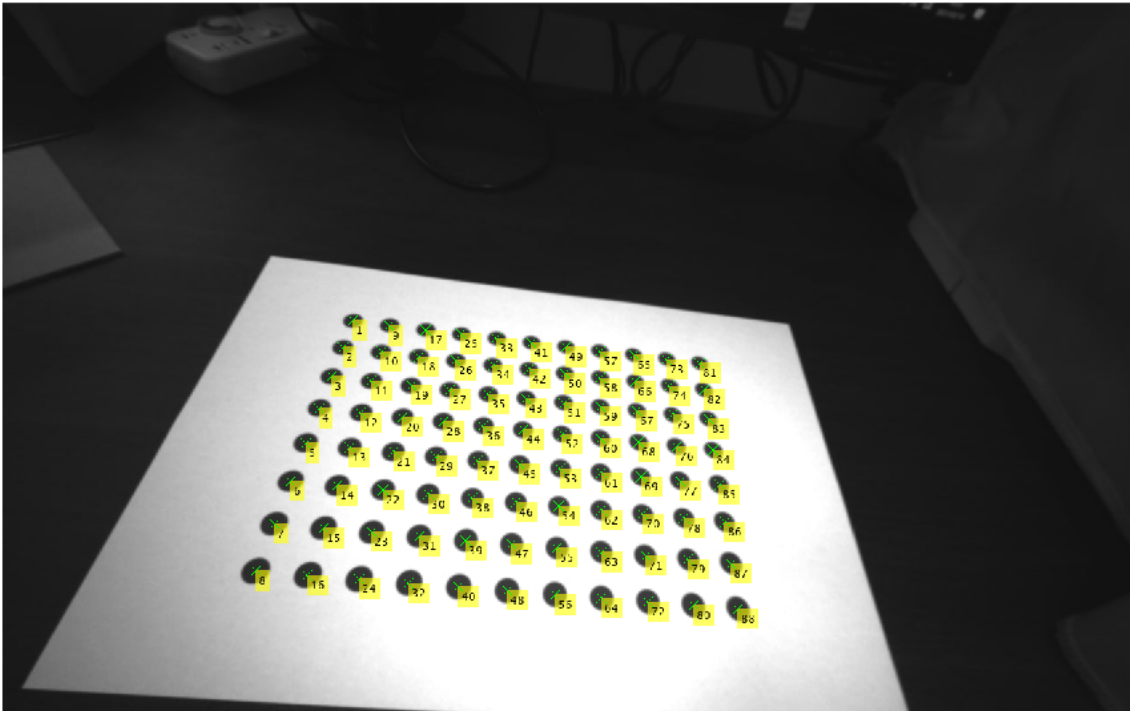

Detect Asymmetric Circle Grid in Stereo Images

Specify your calibration images.

```
imageDir = fullfile(toolboxdir('vision'),'visiondata', ...
                    'calibration','circleGrid','stereo');
leftImages = imageDatastore(fullfile(imageDir,'left'));
rightImages = imageDatastore(fullfile(imageDir,'right'));
images1 = leftImages.Files;
images2 = rightImages.Files;
```

Define the dimensions for the circle grid pattern.

```
patternDims = [4 11];
```

Detect the circle grid points in the images.

```
[imagePoints,pairsUsed] = detectCircleGridPoints(images1,images2,patternDims);
```

Display the points from the first four images of camera one.

```
figure
t1 = tiledlayout(2,2,TileSpacing="compact",Padding="compact");
for i = 1:4
    nexttile
```

```

imshow(images1{i})
hold on
plot(imagePoints(:,1,i,1),imagePoints(:,2,i,1),"gx");
end
title(t1,"Camera 1")

```

Camera 1

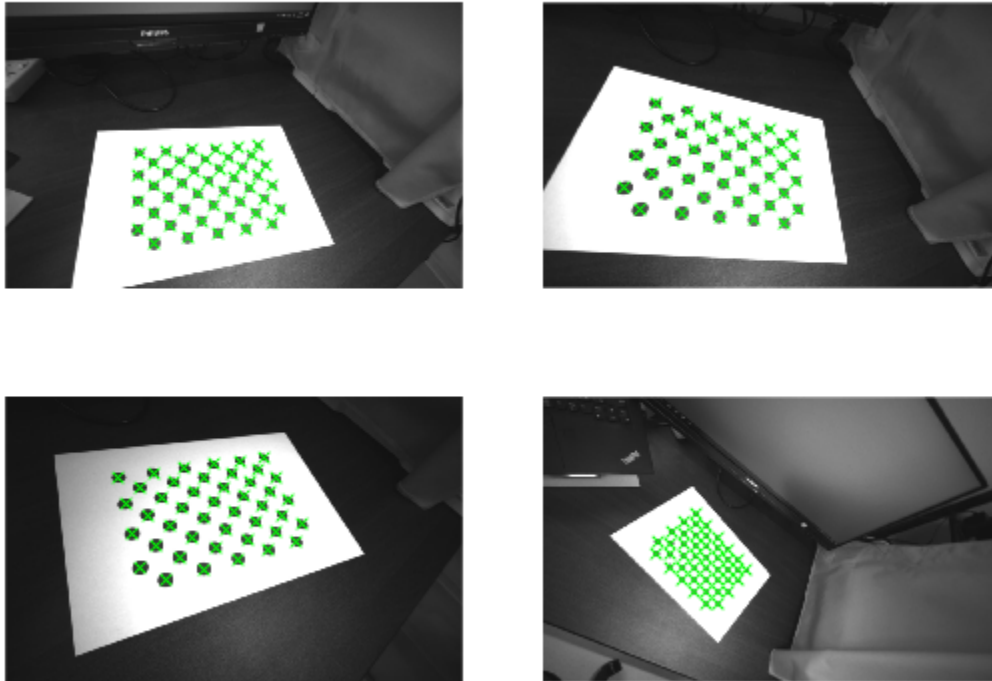

Display points from the first four images from camera two.

```

images2 = images2(pairsUsed);
figure
t2 = tiledlayout(2,2,TileSpacing="compact",Padding="compact");
for i = 1:4
    nexttile
    imshow(images2{i})
    hold on
    plot(imagePoints(:,1,i,2),imagePoints(:,2,i,2),"gx");
end
title(t2,"Camera 2")

```

Camera 2

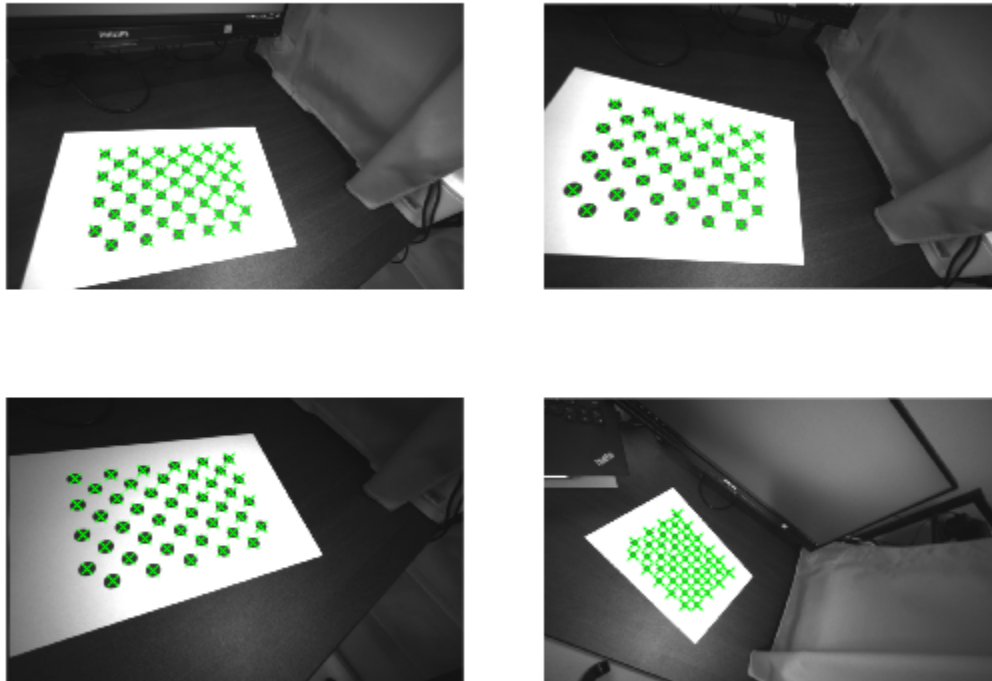

Input Arguments

patternDims – Pattern dimensions

two-element vector

Pattern dimensions, specified as a two-element vector that represents the number of circles in the x and y dimensions of the image, respectively. For more details on circle grid patterns, see “Circle Grid Patterns”.

Asymmetric	Symmetric
<p>Dim2=5</p> <p>Dim1=3</p> <p>center-to-center distance</p>	<p>Columns: 4</p> <p>Rows: 5</p> <p>center-to-center distance</p>

I – Image

2-D truecolor image | grayscale image

Image, specified as a 2-D truecolor image or grayscale image.

Data Types: uint8 | int16 | uint16 | single | double

images — Images

H-by-W-by-numColorChannels-by-numImages array

Images, specified as an *H-by-W-by-numColorChannels-by-numImages* array, where *H* and *W* describe the height and width of each image, respectively. *numColorChannels* is the number of color channels in each image, and *numImages* is the number of images.

Data Types: uint8 | int16 | uint16 | single | double

images1 — Stereo pair images from camera one

H-by-W-by-numColorChannels-by-numImages array

Stereo pair images from camera one, specified as an *H-by-W-by-numColorChannels-by-numImages* array, where *H* and *W* describe the height and width of each image, respectively. *numColorChannels* is the number of color channels in each image, and *numImages* is the number of images

Data Types: uint8 | int16 | uint16 | single | double

images2 — Stereo pair images from camera two

H-by-W-by-numColorChannels-by-numImages array

Stereo pair images from camera two, specified as an *H-by-W-by-numColorChannels-by-numImages* array, where *H* and *W* describe the height and width of each image, respectively. *numColorChannels* is the number of color channels in each image, and *numImages* is the number of images

Data Types: uint8 | int16 | uint16 | single | double

imageFileNames — Image file names

cell array of character vectors | array of strings

Image file names, specified as a cell array of character vectors or an array of strings.

imageFileNames1 — Stereo image file names for camera one

cell array of character vectors | array of strings

Stereo image file names for camera one, specified as a cell array of character vectors or an array of strings.

imageFileNames2 — Stereo image file names for camera two

cell array of character vectors | array of strings

Stereo image file names for camera two, specified as a cell array of character vectors or an array of strings.

Name-Value Pair Arguments

Specify optional pairs of arguments as `Name1=Value1, ..., NameN=ValueN`, where `Name` is the argument name and `Value` is the corresponding value. Name-value arguments must appear after other arguments, but the order of the pairs does not matter.

Example: `detectCircleGridPoints(I,patternDims,PatternType="symmetric")` detects a symmetric circle grid in the specified workspace.

PatternType — Circle grid pattern type`"asymmetric" (default) | "symmetric"`

Circle grid pattern type, specified as `"asymmetric"` or `"symmetric"`.

circleColor — Circle color`"black" (default) | "white"`

Circle color, specified as `"black"` or `"white"`. Choose the color for the circle that has the strongest contrast with the background.

Output Arguments**imagePoints — Center coordinates of detected circle grid**`M-by-2 matrix | M-by-2-by- numPairs-by-2 array`

Center coordinates of detected circle grid, returned as an *M*-by-2 matrix or an *M*-by-2-by-*numPairs*-by-2 array. *M* is the number of circle grids detected, calculated as the product of the number of circle grids detected in each dimension. Each row of the matrix or array specifies the x-y coordinates of the center of a circle grid.

- For single images — This argument is an *M*-by-2 matrix when detecting circle grids in single images.
- For stereo pairs — This argument is an *M*-by-2-by-*numPairs*-by-2 array when detecting circle grids in stereo pairs of images. *numPairs* is the number of image pairs in which a circle grid is detected. `imagePoints(:, :, :, 1)` returns the points from the first set of images, and `imagePoints(:, :, :, 2)` are the points from the second set.

imagesUsed — Pattern detection flag

logical vector

Pattern detection flag, returned as a logical vector. A value of `true` in the `imagesUsed` vector indicates that the pattern has been detected in the corresponding image.

pairsUsed — Stereo pair pattern detection flag

logical vector

Stereo pair pattern detection flag, returned as a logical vector. A value of `true` in the `pairsUsed` vector indicates that the pattern has been detected in the corresponding image pair.

Algorithms

For a circle grid pattern to be detected, the pattern must:

- Contain at least 16 circles
- Be fully visible in the image of a single camera or in both images of a pair of stereo cameras

See Also**Apps****Camera Calibrator | Stereo Camera Calibrator**

Functions

generateCircleGridPoints | estimateCameraParameters | detectCheckerboardPoints

Objects

cameraParameters | stereoParameters

Topics

“Camera Calibration Using AprilTag Markers”

Introduced in R2021b

writeVideoScenes

Write video sequence to video file

Syntax

```
filenames = writeVideoScenes(gTruth,timeRanges, folderNames)
filenames = writeVideoScenes(gTruth,timeRanges, rootFolder, folderNames)
filenames = writeVideoScenes( ____, Name=Value)
```

Description

`filenames = writeVideoScenes(gTruth,timeRanges, folderNames)` writes sequences of ground truth data to separate files, `filenames`, that correspond to time ranges, `timeRanges`. Video files are written to the folders specified by the `folderNames` input.

The function writes video scenes using the image data and corresponding timestamp data contained in the specified `groundTruth` objects. All nonimage data, such as lidar, is ignored.

`filenames = writeVideoScenes(gTruth,timeRanges, rootFolder, folderNames)` also specifies the root folder name to prepend to each of the folder names.

`filenames = writeVideoScenes(____, Name=Value)` specifies options using name-value arguments, in addition to any combination of input arguments from previous syntaxes. For example, `writeVideoScenes(gTruth,timeRanges, folderNames, Verbose=true)` displays progress information while writing video scenes to files.

Examples

Gather Scene Label Information and Write Video Scenes to Files

Load ground truth scene label definitions and label data into the workspace.

```
data = load("groundTruthSceneLabels.mat");
labelDefinitions = data.labelDefinitions;
labelData = data.labelData;
```

Create a ground truth data source using a video file.

```
gSource = groundTruthDataSource("viptrain.avi");
```

Create a ground truth object using the ground truth data source.

```
gTruth = groundTruth(gSource, labelDefinitions, labelData);
```

Gather all the scene time ranges and the scene labels.

```
[timeRanges, sceneLabels] = sceneTimeRanges(gTruth);
```

Select a folder in the temp directory to write the video scenes to.

```
rootFolder = fullfile(tempdir, "videoScenes");
```

Use the scene label names as folder names.

```
folderNames = sceneLabels;
```

Write the video scenes to the "videoScenes" folder. Specify the subfolder names for each duration as the scene label names.

```
filenames = writeVideoScenes(gTruth,timeRanges,rootFolder, folderNames);
```

```
[=====] 100%
Elapsed time: 00:00:03
Estimated time remaining: 00:00:00
```

Input Arguments

gTruth — Ground truth

vector of `groundTruth` objects | vector of `groundTruthMultisignal` objects

Ground truth, specified as a vector of `groundTruth` objects or `groundTruthMultisignal` objects.

timeRanges — Time ranges of ground truth source data

M -by-1 cell array | M -by- N cell array

Time ranges of ground truth source data, specified as an M -by-1 cell array for a `groundTruth` object or an M -by- N cell array for a `groundTruthMultisignal` object. M is the number of elements in `gTruth` and N represents the number of signals per element. Each cell of the array contains a T -by-2 duration matrix, where T is the number of time ranges in the corresponding element of `gTruth`. Each row of the matrix corresponds to a time range in the ground truth data for which a scene label has been applied, specified in the form [*rangeStart rangeEnd*].

folderNames — Folder names

M -1 cell array | M -by- N cell array

Folder names for the video scenes, specified as an M -by-1 cell array for a `groundTruth` object or an M -by- N cell array for a `groundTruthMultisignal` object. Each cell in the cell array corresponds to an element of `gTruth`, and contains a T -by-1 vector of strings or categorical vector that specifies the paths to the folders for the corresponding time ranges.

You must specify each folder name must be specified as a full path or as a relative path from the current folder. When you specify a folder name that does not exist, the function creates a new folder with the specified name. When writing video scene files, the function overwrites files with the same name that already exists in the specified folder. For example, if you call the `writeVideoScenes` function twice with the same input arguments, the files output by the second function call overwrite those from the first.

To select and write specific signals in a `groundTruthMultisignal` object to a specified location, use the `selectLabelsBySignalName` function before calling the `writeVideoScene` function.

rootFolder — Root folder name

character vector | string scalar

Root folder name to prepend to each of the folder names, specified as a character vector or a string scalar.

Name-Value Pair Arguments

Specify optional pairs of arguments as `Name1=Value1, . . . , NameN=ValueN`, where `Name` is the argument name and `Value` is the corresponding value. Name-value arguments must appear after other arguments, but the order of the pairs does not matter.

Example: `writeVideoScenes(gTruth,timeRanges,folderNames,Verbose=true)` displays progress information while writing video scenes to files.

NamePrefix — File name prefix

array of strings | cell array of character vectors

File name prefix, specified as an array of strings or a cell array of character vectors. Default values depend on the `gTruth` input type:

- `groundTruth` object — The function uses the file names (without their extension) in the `DataSource` property of the `groundTruth` object.
- `groundTruthMultisignal` object — The function uses the input signal names.

VideoProfile — Video profile

"Motion JPEG AVI" (default) | "Archival" | "Motion JPEG 2000" | "MPEG-4" | "Uncompressed AVI" | "Indexed AVI" | "Grayscale AVI"

Video profile for writing video scenes, specified as one of the video profiles listed in the table. The `VideoProfile` argument usage is the same as the `profile` argument of the `VideoWriter` object.

Value of VideoProfile	Description
"Archival"	Motion JPEG 2000 file with lossless compression
"Motion JPEG AVI"	AVI file using Motion JPEG encoding
"Motion JPEG 2000"	Motion JPEG 2000 file
'MPEG-4'	MPEG-4 file with H.264 encoding (systems with Windows 7 or later, or macOS 10.7 and later)
'Uncompressed AVI'	Uncompressed AVI file with RGB24 video
'Indexed AVI'	Uncompressed AVI file with indexed video
'Grayscale AVI'	Uncompressed AVI file with grayscale video

Verbose — Display progress on screen

true or 1 (default) | false or 0

Display progress on screen, specified as a logical 1(true) or 0(false).

Output Arguments

filenames — Full path file names

M-by-1 cell array

Full path file names to the saved video scenes, returned as an *M*-by-1 cell array of *T*-by-1 vector of strings. *M* is the number of elements in the `gTruth` input argument. *T* is the number of time ranges in the corresponding element of `gTruth`. Each element of the vector of strings specifies the full path to the saved video scene for the corresponding time range.

The function sets the output file names as `NamePrefix_UID.EXT`, where `UID` is a unique integer index for each written scene and `EXT` is the video file extension determined by the `VideoProfile` argument.

See Also

Objects

`groundTruthMultisignal` | `groundTruthDataSource` | `groundTruth`

Functions

`selectLabelsBySignalName` | `gatherLabelData` | `objectDetectorTrainingData` | `pixelLabelTrainingData` | `sceneTimeRanges`

Introduced in R2021b

sceneTimeRanges

Time ranges of scene labels from ground truth data

Syntax

```
timeRanges = sceneTimeRanges(gTruth)
[timeRanges,sceneLabels] = sceneTimeRanges(gTruth)
```

Description

`timeRanges = sceneTimeRanges(gTruth)` returns the time ranges that define the start and end times for the scene labels applied to the ground truth data sources in `gTruth`.

`[timeRanges,sceneLabels] = sceneTimeRanges(gTruth)` also returns the scene labels that correspond to the time ranges.

Examples

Gather Scene Time Ranges and Scene Labels

Load ground truth scene label definitions and label data into the workspace.

```
data = load("groundTruthSceneLabels.mat");
labelDefinitions = data.labelDefinitions;
labelData = data.labelData;
```

Create a ground truth data source using a video file.

```
gSource = groundTruthDataSource("viptrain.avi");
```

Create a ground truth object using the ground truth data source.

```
gTruth = groundTruth(gSource,labelDefinitions,labelData);
```

Gather all the scene time ranges and the scene labels.

```
[timeRanges,sceneLabels] = sceneTimeRanges(gTruth);
```

Display the scene time ranges for the ground truth data.

```
timeRanges{1}
ans = 3x2 duration
      0 sec   8.0333 sec
      8.3 sec  10.033 sec
      12 sec  16.333 sec
```

Display the corresponding scene labels for the ground truth data.

```
sceneLabels{1}
```

```
ans = 3x1 categorical  
    walking  
    sitting  
    trainMoving
```

Input Arguments

gTruth — Ground truth

vector of `groundTruth` objects | vector of `groundTruthMultisignal` objects

Ground truth, specified as a vector of `groundTruth` objects or `groundTruthMultisignal` objects.

Output Arguments

timeRanges — Time ranges of ground truth source data

M-by-1 cell array

Time ranges of the ground truth source data, returned as an *M*-by-1 cell array. *M* is the number of elements in `gTruth`. Each of the cell array contains a *T*-by-2 duration matrix. *T* is the number of time ranges in the corresponding element of `gTruth`. Each row of the matrices corresponds to a time range in the ground truth data for which a scene label has been applied, specified in the form `[rangeStart rangeEnd]`.

To select and obtain scene time ranges for specific signals in a `groundTruthMultisignal` object, use the `selectLabelsBySignalName` function before calling the `sceneTimeRanges` function.

sceneLabels — Scene labels for each time range

M-by-1 cell array of categorical vectors

Scene labels for each time range, returned as an *M*-by-1 cell array of *T*-by-2 categorical vectors. *M* is the number of elements in `gTruth`. *T* is the number of time ranges in each corresponding ground truth data source.

See Also

Objects

`groundTruthMultisignal` | `groundTruthDataSource` | `groundTruth`

Functions

`selectLabelsBySignalName` | `gatherLabelData` | `objectDetectorTrainingData` | `pixelLabelTrainingData` | `writeVideoScenes`

Introduced in R2021b

stereoParametersFromOpenCV

Convert stereo camera parameters from OpenCV to MATLAB

Syntax

```
stereoParams = stereoParametersFromOpenCV(intrinsicMatrix1,
distortionCoefficients1,intrinsicMatrix2,distortionCoefficients2,
rotationOfCamera2,translationOfCamera2,imageSize)
stereoParams = stereoParametersFromOpenCV( ____,WorldUnits=worldUnits)
```

Description

`stereoParams = stereoParametersFromOpenCV(intrinsicMatrix1, distortionCoefficients1, intrinsicMatrix2, distortionCoefficients2, rotationOfCamera2, translationOfCamera2, imageSize)` converts the OpenCV stereo parameters, specified by the input arguments, into a MATLAB `stereoParameters` object `stereoParams`.

The OpenCV spatial coordinate system specifies the upper-left pixel center at $(0, 0)$, whereas the MATLAB spatial coordinate system specifies the pixel center at $(1, 1)$. The `stereoParametersFromOpenCV` function compensates for this difference by adding 1 to both of the x and y -values for the converted principal point.

OpenCV stereo parameters cannot be converted to a MATLAB `stereoParameters` object when:

- The OpenCV pinhole camera model uses more than five distortion coefficients.
- An OpenCV fisheye model is used.

In these cases, you can recalibrate the stereo camera using the **Stereo Camera Calibrator** app.

`stereoParams = stereoParametersFromOpenCV(____, WorldUnits=worldUnits)` specifies a string `worldUnits`, that describes the units of the world points in addition to the input arguments from the previous syntax. Specify `worldUnits` as a character vector or string scalar. For example, `stereoParametersFromOpenCV(____, WorldUnits="mm")` describes all parameters in terms of the world units "mm".

Examples

Rectify Stereo Images in MATLAB Using Stereo Parameters From OpenCV

Load OpenCV stereo parameters from a MAT file into the workspace.

```
load openCVStereoParameters.mat
```

Convert the loaded stereo parameters from OpenCV to MATLAB format.

```
stereoParams = stereoParametersFromOpenCV(intrinsicMatrix1, ...
    distortionCoefficients1,intrinsicMatrix2,distortionCoefficients2, ...
    rotationOfCamera2,translationOfCamera2,imageSize);
```

Load the images to rectify.

```
imageDir = fullfile(toolboxdir('vision'),'visiondata','calibration','stereo');  
I1 = imread(fullfile(imageDir,'left','left01.png'));  
I2 = imread(fullfile(imageDir,'right','right01.png'));
```

Display the unrectified images.

```
imshow(stereoAnaglyph(I1,I2));
```

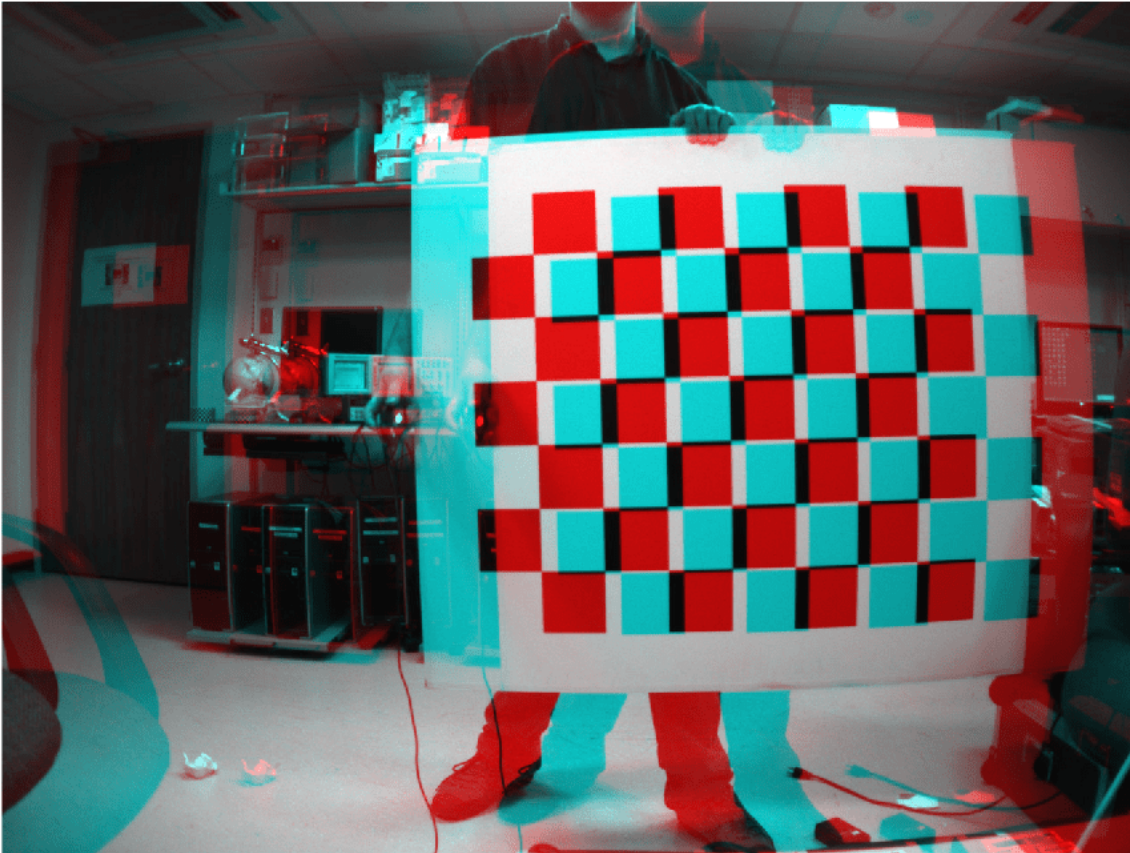

Rectify the images using the full output view.

```
[J1,J2] = rectifyStereoImages(I1,I2, stereoParams, OutputView='full');
```

Display the resulting rectified images.

```
imshow(stereoAnaglyph(J1,J2));
```

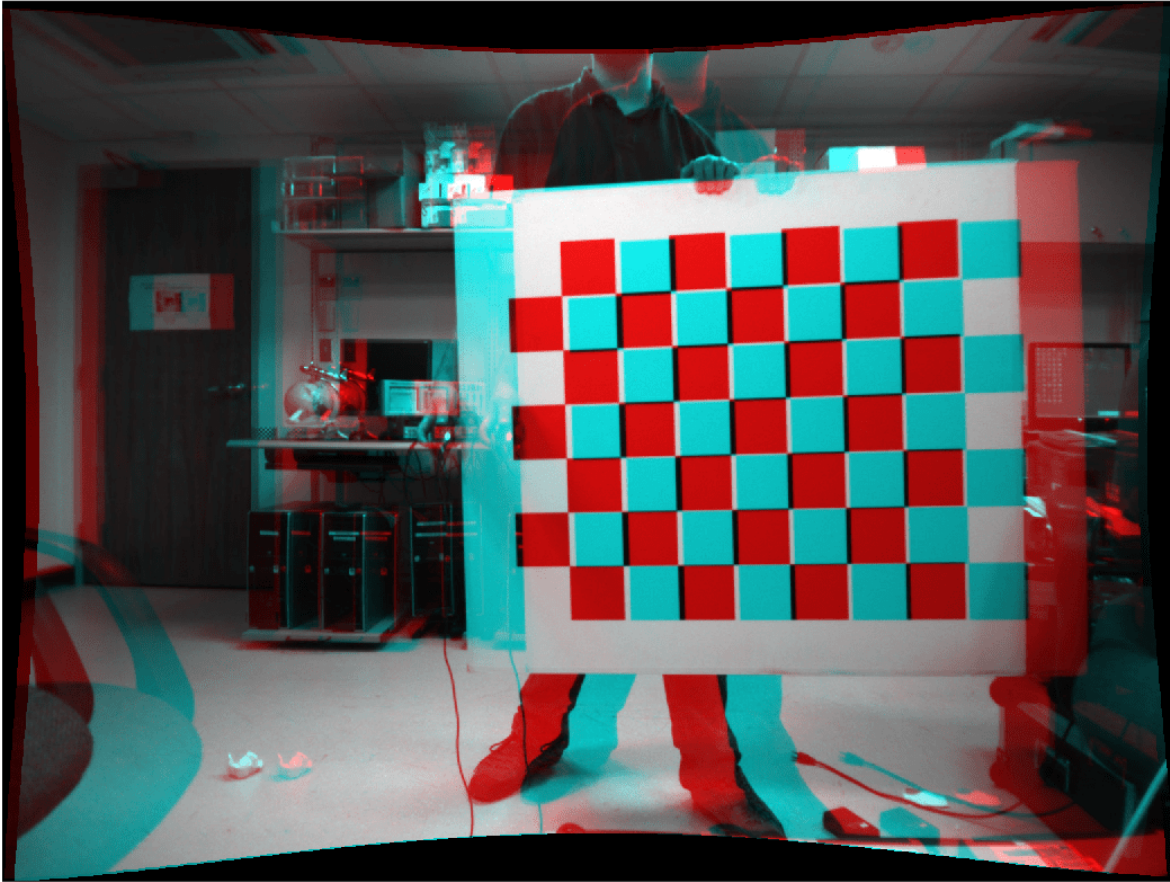

Import Stereo Camera Parameters from ROS

The ROS camera calibration package estimates stereo camera parameters using the OpenCV camera calibration tools [1]. After calibrating a stereo camera in ROS, you can export its camera parameters to an INI file using the camera calibration parser. To use the calibrated stereo camera with Computer Vision Toolbox™ functions, such as `rectifyStereoImages`, you must read the camera parameters from the INI file and convert them into a `stereoParameters` object using `stereoParametersFromOpenCV`.

Note: The `stereoParametersFromOpenCV` function supports importing stereo camera parameters for only those pinhole camera models that use the ROS `plumb-bob` distortion model.

Read Stereo Camera Parameters from ROS INI File

Read the stereo camera parameters stored in `stereoParams.ini` using the helper function `helperReadINI`.

```
stereoParamsINI = helperReadINI("stereoParams.ini");
```

Compute Baseline Parameters of Stereo Camera

The baseline parameters of a stereo camera describe the relative translation and rotation of the two cameras in the stereo camera pair. The relative rotation and translation of camera 2 with respect to camera 1 is required to create the `stereoParameters` object using `stereoParametersFromOpenCV`. You can compute these from the rectification and projection matrices read from the ROS INI file [2].

Extract the two camera parameters from the `stereoParams` structure.

```
cameraParams1 = stereoParamsINI.narrow_stereo_left;
cameraParams2 = stereoParamsINI.narrow_stereo_right;
```

Extract the translation of camera 2 relative to camera 1 from the last column of the projection matrix.

```
translationOfCamera2 = cameraParams2.projection(:,end);
```

The rotation of camera 2 relative to camera 1, R_{21} , is derived from the rectification matrices of the stereo pair R_1 and R_2 . The rectification matrices are the rotation matrices that align the camera coordinate system to the ideal stereo image plane such that epipolar lines in both stereo images are parallel. Compute the rotation of camera 2 relative to camera 1 as $R_{21} = R_2 * R_1^T$.

```
rotationOfCamera2 = cameraParams2.rectification*cameraParams1.rectification';
```

Create stereoParameters Object using stereoParametersFromOpenCV

Extract the intrinsic matrices and distortion coefficients of the two cameras from the `stereoParams` structure.

```
intrinsicMatrix1 = cameraParams1.camera_matrix;
intrinsicMatrix2 = cameraParams2.camera_matrix;
```

```
distortionCoefficients1 = cameraParams1.distortion;
distortionCoefficients2 = cameraParams2.distortion;
```

Obtain the image size from the image field of the `stereoParams` structure.

```
imageSize = [stereoParamsINI.image.height stereoParamsINI.image.width];
```

Use `stereoParametersFromOpenCV` to create a `stereoParameters` object from the ROS stereo camera parameters.

```
stereoParametersObj = stereoParametersFromOpenCV(intrinsicMatrix1, ...
    distortionCoefficients1,intrinsicMatrix2,distortionCoefficients2, ...
    rotationOfCamera2,translationOfCamera2,imageSize);
```

Rectify Pair of Stereo Images

Use the imported stereo parameters with `rectifyStereoImages` to rectify an image pair captured using the calibrated stereo camera.

```
% Load the image pair.
imageDir = fullfile(toolboxdir('vision'),'visiondata','calibration','stereo');
leftImages = imageDatastore(fullfile(imageDir,'left'));
rightImages = imageDatastore(fullfile(imageDir,'right'));
I1 = readimage(leftImages,1);
I2 = readimage(rightImages,1);
```



```

% Rectify the image pair.
[J1,J2] = rectifyStereoImages(I1,I2,stereoParametersObj,OutputView='full');

% Display the results.
figure
J = stereoAnaglyph(J1,J2);
imshow(J)

```

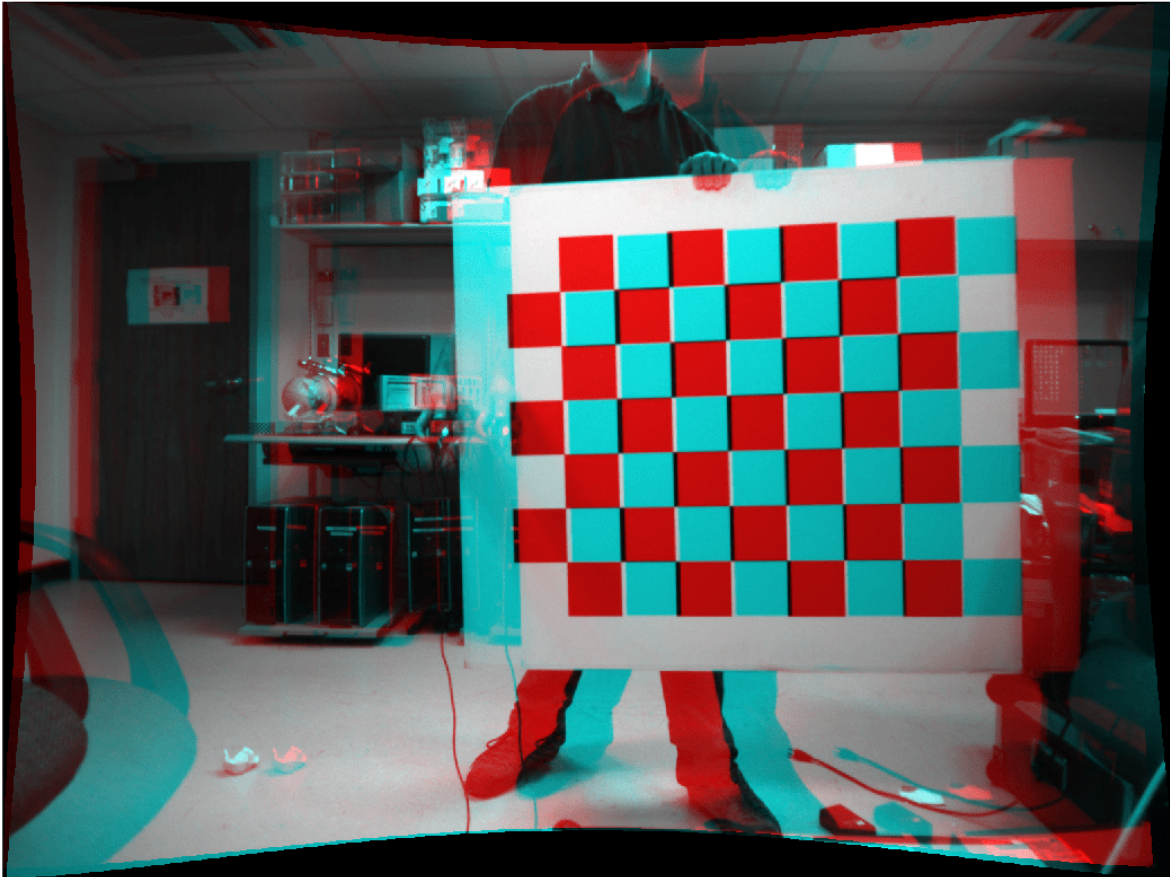

Supporting Functions

helperReadINI

The helperReadINI function reads the camera parameters from its input INI file that has been exported from ROS.

```

function cameraParams = helperReadINI(filename)
% helperReadINI reads a ROS INI file, filename, and returns a structure with
% these fields: image, <camera_name1>, <camera_name2>. image is a
% structure describing the height and width of the image captured by the
% cameras of the stereo pair. The fields <camera_name1> and <camera_name2>
% are structures named after the camera names present in the INI file, and they contain
% these fields: camera_matrix, distortion, rectification_matrix,

```

```
% and projection_matrix. These fields are stored in the INI file with their
% values placed in a new line followed by their name.

f = fopen(filename, 'r');
sectionName = '';

while ~feof(f)
    % Read line from file.
    line = fgetl(f);

    % Trim leading and trailing whitespaces.
    line = strtrim(line);

    if isempty(line) || line(1)=='#'
        % Skip empty line and comments.
        continue
    elseif line(1) == '[' && line(end) == ']'
        % Identify section names and continue reading.
        sectionName = line(2:end-1);
        sectionName = strrep(sectionName, '/', '_');
        continue
    end

    % Replace blankspaces with underscores to create valid MATLAB variable
    % name.
    name = line;
    name(name == ' ') = '_';

    % Read the value data in upcoming lines.
    value = [];
    while ~feof(f)
        line = fgetl(f);
        line = strtrim(line);

        if isempty(line)
            % A empty line indicates end of value data.
            break
        elseif line(1)=='#'
            % Skip comment lines.
            continue
        end
        line = str2num(line); %#ok
        value = [value; line]; %#ok
    end

    % Store post-processed value.
    if isempty(sectionName)
        cameraParams.(name) = value;
    else
        cameraParams.(sectionName).(name) = value;
    end
end

fclose(f);
end
```

References

[1] http://wiki.ros.org/camera_calibration

[2] http://docs.ros.org/en/melodic/api/sensor_msgs/html/msg/CameraInfo.html

Input Arguments

intrinsicMatrix1 — Intrinsic matrix of camera 1

3-by-3 matrix

Intrinsic matrix of camera 1 from OpenCV, specified as a 3-by-3 matrix of the form:

$$\begin{bmatrix} f_x & 0 & c_x \\ 0 & f_y & c_y \\ 0 & 0 & 1 \end{bmatrix}$$

where f_x and f_y are the focal lengths in the x and y-directions, and (c_x, c_y) is the principal point in specified in OpenCV.

intrinsicMatrix2 — Intrinsic matrix of camera 2

3-by-3 matrix

Intrinsic matrix of camera 2 from OpenCV, specified as a 3-by-3 matrix of the form:

$$\begin{bmatrix} f_x & 0 & c_x \\ 0 & f_y & c_y \\ 0 & 0 & 1 \end{bmatrix}$$

where f_x and f_y are the focal lengths in the x and y-directions, and (c_x, c_y) is the principal point in specified in OpenCV.

distortionCoefficients1 — Camera 1 radial and tangential distortion coefficients

five-element vector

Camera 1 radial and tangential distortion coefficients, returned as a five-element vector in the form $[k_1 \ k_2 \ p_1 \ p_2 \ k_3]$. The values of k_1 , k_2 , and k_3 describe the radial distortion and p_1 and p_2 describe the tangential distortion, specified in OpenCV.

distortionCoefficients2 — Camera 2 radial and tangential distortion coefficients

five-element vector

Camera 2 radial and tangential distortion coefficients, returned as a five-element vector in the form $[k_1 \ k_2 \ p_1 \ p_2 \ k_3]$. The values of k_1 , k_2 , and k_3 describe the radial distortion and p_1 and p_2 describe the tangential distortion, specified in OpenCV.

rotationOfCamera2 — Rotation of camera 2 relative to camera 1

3-by-3 matrix

Rotation of camera 2 relative to camera 1 from OpenCV, specified as a 3-by-3 matrix.

translationOfCamera2 — Translation of camera 2 relative to camera 1

three-element vector

Translation of camera 2 relative to camera 1 from OpenCV, specified as a three-element vector.

imageSize — Image size

two-element vector

Image size, specified as a two-element vector in the form [*mrows*,*ncols*].

Output Arguments**stereoParams — Stereo parameters**

stereoParameters object

Stereo parameters, returned as a stereoParameters object.

See Also**Apps**

[Stereo Camera Calibrator](#) | [Camera Calibrator](#)

Objects

[cameraParameters](#) | [stereoParameters](#)

Functions

[undistortImage](#) | [stereoAnaglyph](#) | [stereoParametersToOpenCV](#) | [cameraIntrinsicsFromOpenCV](#) | [cameraIntrinsicsToOpenCV](#)

Introduced in R2021b

stereoParametersToOpenCV

Convert stereo camera parameters from MATLAB to OpenCV

Syntax

```
[intrinsicMatrix1,distortionCoefficients1,intrinsicMatrix2,
distortionCoefficients2,rotationOfCamera2,translationOfCamera2,imageSize] =
stereoParametersToOpenCV(stereoParams)
```

Description

[intrinsicMatrix1,distortionCoefficients1,intrinsicMatrix2,distortionCoefficients2,rotationOfCamera2,translationOfCamera2,imageSize] = stereoParametersToOpenCV(stereoParams) converts a MATLAB stereoParameters object stereoParams to OpenCV stereo parameters.

The OpenCV spatial coordinate system specifies the upper-left pixel center at $(0, 0)$, whereas the MATLAB spatial coordinate system specifies the pixel center at $(1, 1)$. The stereoParametersToOpenCV function compensates for this difference by subtracting 1 to both of the x and y-values for the converted principal point.

OpenCV stereo parameters do not include the skew of a pinhole camera model. Therefore, only the intrinsics estimated without the skew can be exported to OpenCV.

Examples

Calibrate Stereo Camera and Convert Parameters To OpenCV Format

Specify the calibration images.

```
leftImages = imageDatastore(fullfile(toolboxdir('vision'),'visiondata', ...
    'calibration','stereo','left'));
rightImages = imageDatastore(fullfile(toolboxdir('vision'),'visiondata', ...
    'calibration','stereo','right'));
```

Detect the checkerboards in the image pairs.

```
[imagePoints,boardSize] = detectCheckerboardPoints(leftImages.Files,rightImages.Files);
```

Specify the world coordinates of the checkerboard keypoints in millimeters.

```
squareSize = 108;
worldPoints = generateCheckerboardPoints(boardSize,squareSize);
```

Calibrate the stereo camera system. Both cameras have the same resolution.

```
I = readimage(leftImages,1);
imageSize = [size(I,1),size(I,2)];
stereoParams = estimateCameraParameters(imagePoints,worldPoints, ...
    ImageSize=imageSize);
```

Convert the MATLAB stereo parameters object to the OpenCV format.

```
[intrinsicMatrix1,distortionCoefficients1,intrinsicMatrix2, ...
    distortionCoefficients2,rotationOfCamera2,translationOfCamera2] =...
    stereoParametersToOpenCV(stereoParams);
```

Input Arguments

stereoParams — Stereo parameters

stereoParameters object

Stereo parameters, specified as a stereoParameters object.

Output Arguments

intrinsicMatrix1 — Intrinsic matrix of camera 1

3-by-3 matrix

Intrinsic matrix of camera 1 formatted for OpenCV, returned as a 3-by-3 matrix of the form:

$$\begin{bmatrix} f_x & 0 & c_x \\ 0 & f_y & c_y \\ 0 & 0 & 1 \end{bmatrix}$$

where f_x and f_y are the focal lengths in the x and y -directions, and (c_x,c_y) is the principal point in specified in the OpenCV input.

intrinsicMatrix2 — Intrinsic matrix of camera 2

3-by-3 matrix

Intrinsic matrix of camera 2 formatted for OpenCV, returned as a 3-by-3 matrix of the form:

$$\begin{bmatrix} f_x & 0 & c_x \\ 0 & f_y & c_y \\ 0 & 0 & 1 \end{bmatrix}$$

where f_x and f_y are the focal lengths in the x and y -directions, and (c_x,c_y) is the principal point in specified in the OpenCV input.

distortionCoefficients1 — Camera 1 radial and tangential distortion coefficients

five-element vector

Camera 1 radial and tangential distortion coefficients, returned as a five-element vector in the form $[k_1 k_2 p_1 p_2 k_3]$. The values of k_1 , k_2 , and k_3 describe the radial distortion and p_1 and p_2 describe the tangential distortion, specified in OpenCV.

distortionCoefficients2 — Camera 2 radial and tangential distortion coefficients

five-element vector

Camera 2 radial and tangential distortion coefficients, returned as a five-element vector in the form $[k_1 k_2 p_1 p_2 k_3]$. The values of k_1 , k_2 , and k_3 describe the radial distortion and p_1 and p_2 describe the tangential distortion, specified in OpenCV.

rotationOfCamera2 — Rotation of camera 2 relative to camera 1

3-by-3 matrix

Rotation of camera 2 relative to camera 1 from OpenCV, specified as a 3-by-3 matrix.

translationOfCamera2 — Translation of camera 2 relative to camera 1

three-element vector

Translation of camera 2 relative to camera 1 from OpenCV, specified as a three-element vector.

imageSize — Image size

two-element vector

Image size, specified as a two-element vector in the form [*mrows,ncols*].

See Also**Apps**[Stereo Camera Calibrator](#) | [Camera Calibrator](#)**Objects**[cameraParameters](#) | [stereoParameters](#)**Functions**[undistortImage](#) | [stereoAnaglyph](#) | [cameraIntrinsicsFromOpenCV](#) | [stereoParametersFromOpenCV](#) | [stereoParametersToOpenCV](#)**Introduced in R2021b**

cameraIntrinsicsFromOpenCV

Convert camera intrinsic parameters from OpenCV to MATLAB

Syntax

```
intrinsics = cameraIntrinsicsFromOpenCV(intrinsicMatrix,  
distortionCoefficients,imageSize)
```

Description

`intrinsics = cameraIntrinsicsFromOpenCV(intrinsicMatrix, distortionCoefficients, imageSize)` converts the OpenCV intrinsics, specified by the input arguments, into a MATLAB `cameraIntrinsics` object `intrinsics`.

The OpenCV spatial coordinate system specifies the upper-left pixel center at $(0, 0)$, whereas the MATLAB spatial coordinate system specifies the pixel center at $(1, 1)$. The `cameraIntrinsicsFromOpenCV` function compensates for this difference by adding 1 to both of the x and y -values for the converted principal point.

OpenCV intrinsics cannot be converted to a MATLAB `cameraIntrinsics` object when:

- The OpenCV pinhole camera model uses more than five distortion coefficients.
- An OpenCV fisheye model is used.

In these cases, you can recalibrate the stereo camera using the **Camera Calibrator** app.

Examples

Undistort Image in MATLAB Using Camera Intrinsics from OpenCV

Define OpenCV camera intrinsic parameters in the workspace.

```
intrinsicMatrix = [729.4644    0    570.6455;  
                  0    728.8196  346.0108;  
                  0     0     1   ];  
distortionCoefficients = [-0.4262  0.5460  0.0038  -0.0051  -0.6176];
```

Define the image size returned by the camera.

```
imageSize = [712 1072];
```

Convert the intrinsic parameters from OpenCV to MATLAB format.

```
intrinsics = cameraIntrinsicsFromOpenCV(intrinsicMatrix, ...  
                                         distortionCoefficients,imageSize);
```

Load the image to undistort.

```
filename = fullfile(toolboxdir("vision"),"visiondata","calibration", ...  
                   "mono","image01.jpg");  
I = imread(filename);
```

Undistort the image and display the results.

```
J = undistortImage(I,intrinsics);
imshowpair(I,J,"montage");
title("Original Image (left) vs. Corrected Image (right)");
```



Import Camera Intrinsic Parameters from ROS

The ROS camera calibration package estimates camera intrinsic parameters using the OpenCV camera calibration tools [1]. After calibrating a camera in ROS, you can import its intrinsic parameters to a YAML file using the camera calibration parser in ROS. To use the calibrated camera with Computer Vision Toolbox™ functions, such as `undistortImage`, you must read the camera parameters from the YAML file and then convert them into a `cameraIntrinsics` object using `cameraIntrinsicsFromOpenCV`.

Note: The `cameraIntrinsicsFromOpenCV` function supports importing camera intrinsic parameters for only those pinhole camera models that use the ROS plumb-bob distortion model.

Read Camera Intrinsic Parameters from a ROS YAML File

Read the camera parameters stored in `cameraParams.yaml` using the helper function `helperReadYAML`.

```
intrinsicsParams = helperReadYAML('cameraParams.yaml');
```

Create cameraIntrinsics Object Using cameraIntrinsicsFromOpenCV

Use the `cameraIntrinsicsFromOpenCV` function to create a `cameraIntrinsics` object from the camera matrix and the distortion coefficients.

```
imageSize = [intrinsicsParams.image_height intrinsicsParams.image_width];
intrinsicMatrix = intrinsicsParams.camera_matrix;
distortionCoefficients = intrinsicsParams.distortion_coefficients;

intrinsicsObj = cameraIntrinsicsFromOpenCV(intrinsicMatrix,distortionCoefficients,imageSize);
```

Undistort Image

Use the imported camera intrinsics with `undistortImage` to undistort an image captured using the calibrated camera.

```
% Load the captured image.
imageName = fullfile(toolboxdir('vision'),'visiondata','calibration','stereo','left','left01.png');
I = imread(imageName);

% Undistort the image.
J = undistortImage(I,intrinsicsObj,'OutputView','full');

% Display the result.
figure
montage({I,J})
```

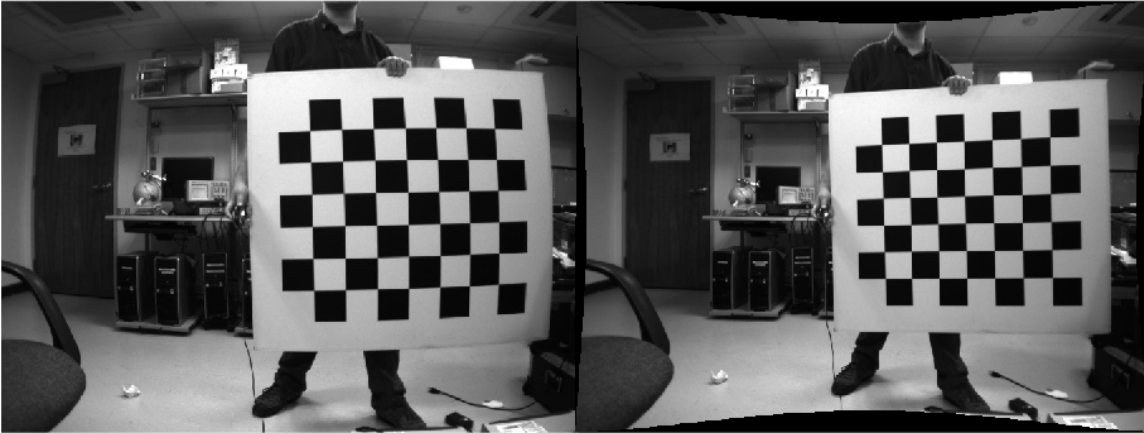

Supporting Functions

helperReadYAML

The `helperReadYAML` function reads the monocular camera parameters from the input YAML file that was exported from ROS.

```
function cameraParams = helperReadYAML(filename)
% helperReadYAML reads a ROS YAML file, filename, and returns a structure
% with these fields: image_width, image_height, camera_name,
% camera_matrix, distortion_model, distortion_coefficients,
% rectification_matrix, and projection_matrix. These fields are stored
% in the YAML file colon separated from their values in different lines.
```

```
    f = fopen(filename,'r');
    stringFields = {'camera_name','distortion_model'};

    while ~feof(f)

        [name,value,isEmptyLine] = helperReadYAMLLine(f);
        if isEmptyLine
            continue
```

```

end
if ~isempty(value)
    % Convert all values to numbers except for known string
    % fields.
    if ~any(contains(name, stringFields))
        value = str2num(value); %#ok
    end
else
    % An empty value in ROS YAML files indicates a matrix in
    % upcoming lines. Read the matrix from the upcoming lines.
    value = helperReadYAMLMatrix(f);
end

% Store post-processed value.
cameraParams.(name) = value;
end

fclose(f);
end

```

helperReadYAMLMatrix

The helperReadYAMLMatrix function reads the rows, columns and data fields of a matrix in the ROS YAML file.

```

function matrix = helperReadYAMLMatrix(f)
% helperReadYAMLMatrix reads a matrix from the ROS YAML file. A matrix in
% a ROS YAML file has three fields: rows, columns and data. rows and col
% describe the matrix size. data is a contiguous array of the matrix
% elements in row-major order. This helper function assumes the presence
% of all three fields of a matrix to return the correct matrix.

numRows = 0;
numCols = 0;
data = [];

% Read numRows, numCols and matrix data.
while ~feof(f)
    [name,value,isEmptyLine] = helperReadYAMLLine(f);

    if isEmptyLine
        continue
    end

    switch name
        case 'rows'
            numRows = str2num(value); %#ok
        case 'cols'
            numCols = str2num(value); %#ok
        case 'data'
            data = str2num(value); %#ok

            % Terminate the while loop as data is the last
            % field of a matrix in the ROS YAML file.
            break
        otherwise
            % Terminate the while loop if any other field is

```

```

                % encountered.
                break
            end
        end

        if numel(data) == numRows*numCols
            % Reshape the matrix using row-major order.
            matrix = reshape(data,[numCols numRows]');
        end
    end
end

```

helperReadYAMLLine

The helperReadYAMLLine function reads a line of a ROS YAML file.

```

function [name,value,isEmptyLine] = helperReadYAMLLine(f)

    % Read line from file.
    line = fgetl(f);

    % Trim leading and trailing whitespaces.
    line = strtrim(line);

    if isempty(line) || line(1)=='#'
        % Empty line or comment.
        name = '';
        value = '';
        isEmptyLine = true;
    else
        % Split the line to get name and value.
        c = strsplit(line,':');
        assert(length(c)==2,'Unexpected file format')

        name = c{1};
        value = strtrim(c{2}); % Trim leading whitespace.
        isEmptyLine = false;
    end
end

```

References

[1] http://wiki.ros.org/camera_calibration

Input Arguments

intrinsicMatrix — Camera intrinsic matrix

3-by-3 matrix

Camera intrinsic matrix from OpenCV, specified as a 3-by-3 matrix of the form:

$$\begin{bmatrix} f_x & 0 & c_x \\ 0 & f_y & c_y \\ 0 & 0 & 1 \end{bmatrix}$$

where f_x and f_y are the focal lengths in the x and y -directions, and (c_x,c_y) is the principal point in OpenCV.

distortionCoefficients — Camera radial and tangential distortion coefficients

five-element vector

Camera radial and tangential distortion coefficients from OpenCV, specified as a five-element vector of the form $[k1\ k2\ p1\ p2\ k3]$. The values of $k1$, $k2$, and $k3$ describe the radial distortion and $p1$ and $p2$ describe the tangential distortion, specified in OpenCV.

imageSize — Image size

2-element vector

Image size, specified as a 2-element vector in the form $[mrows,ncols]$.

Output Arguments**intrinsics** — Camera intrinsic parameters

cameraIntrinsics object

Camera intrinsic parameters, returned as a cameraIntrinsics object.

See Also**Apps**[Stereo Camera Calibrator](#) | [Camera Calibrator](#)**Objects**[cameraParameters](#) | [stereoParameters](#)**Functions**[undistortImage](#) | [stereoAnaglyph](#) | [stereoParametersFromOpenCV](#) | [stereoParametersToOpenCV](#) | [cameraIntrinsicsToOpenCV](#)**Introduced in R2021b**

cameraIntrinsicsToOpenCV

Convert camera intrinsic parameters from MATLAB to OpenCV

Syntax

```
[intrinsicMatrix,distortionCoefficients] = cameraIntrinsicsToOpenCV(
intrinsicMatrix)
```

Description

`[intrinsicMatrix,distortionCoefficients] = cameraIntrinsicsToOpenCV(intrinsicMatrix)` converts a MATLAB `cameraIntrinsics` or `cameraParameters` object, specified by `intrinsicMatrix`, to OpenCV camera intrinsic parameters.

The OpenCV spatial coordinate system specifies the upper-left pixel center at $(0, 0)$, whereas the MATLAB spatial coordinate system specifies the pixel center at $(1, 1)$. The `cameraIntrinsicsToOpenCV` function compensates for this difference by subtracting 1 from both the x and y -values for the converted principal point.

OpenCV camera intrinsic parameters do not include the skew of a pinhole camera model. Therefore, only the intrinsics that were estimated without the skew can be exported to OpenCV.

Examples

Calibrate Camera in MATLAB and Convert Intrinsic Parameters to OpenCV

Create a set of calibration images.

```
images = imageDatastore(fullfile(toolboxdir('vision'),'visiondata', ...
    'calibration','mono'));
imageFileNames = images.Files;
```

Detect the checkerboard calibration pattern in the images.

```
[imagePoints,boardSize] = detectCheckerboardPoints(imageFileNames);
```

Generate the world coordinates of the corners of the squares. Square size is in millimeters.

```
squareSize = 29;
worldPoints = generateCheckerboardPoints(boardSize,squareSize);
```

Calibrate the camera.

```
I = readimage(images,1);
imageSize = [size(I,1),size(I,2)];
params = estimateCameraParameters(imagePoints,worldPoints, ...
    ImageSize=imageSize);
```

Convert the intrinsic parameters to OpenCV format

```
[intrinsicMatrix,distortionCoefficients] = cameraIntrinsicsToOpenCV(params);
```

Input Arguments

intrinsics – Camera intrinsic parameters

cameraIntrinsics object | cameraParameters object

Camera intrinsic parameters, specified as a cameraIntrinsics or a cameraParameters object.

Output Arguments

intrinsicMatrix – Camera intrinsic matrix

3-by-3 matrix

Camera intrinsics matrix formatted for OpenCV, returned as a 3-by-3 matrix of the form:

$$\begin{bmatrix} f_x & 0 & c_x \\ 0 & f_y & c_y \\ 0 & 0 & 1 \end{bmatrix}$$

where f_x and f_y are the focal lengths in the x and y -directions, and (c_x, c_y) is the principal point in OpenCV.

distortionCoefficients – Camera radial and tangential distortion coefficients

five-element vector

Camera radial and tangential distortion coefficients, returned as a five-element vector in the form $[k_1 k_2 p_1 p_2 k_3]$. The values of k_1 , k_2 , and k_3 describe the radial distortion and p_1 and p_2 describe the tangential distortion, specified in OpenCV.

See Also

Apps

[Stereo Camera Calibrator](#) | [Camera Calibrator](#)

Objects

[cameraParameters](#) | [stereoParameters](#)

Functions

[undistortImage](#) | [stereoAnaglyph](#) | [stereoParametersToOpenCV](#) | [cameraIntrinsicsFromOpenCV](#) | [stereoParametersFromOpenCV](#) | [cameraIntrinsicsFromOpenCV](#)

Introduced in R2021b

detectSIFTFeatures

Detect scale invariant feature transform (SIFT) features and return SIFTPoints object

Syntax

```
points = detectSIFTFeatures(I)  
points = detectSIFTFeatures(I,Name=Value)
```

Description

`points = detectSIFTFeatures(I)` detects SIFT features in the 2-D grayscale input image `I` and returns a `SIFTPoints` object. The `detectSIFTFeatures` function implements the Scale-Invariant Feature Transform (SIFT) algorithm to find local features in an image.

`points = detectSIFTFeatures(I,Name=Value)` specifies additional options using one or more name-value arguments.

Examples

Detect Interest Points and Mark Locations

Load an image.

```
I = imread('cameraman.tif');
```

Detect SIFT features in the image.

```
points = detectSIFTFeatures(I);
```

Display the results

```
imshow(I);  
hold on;  
plot(points.selectStrongest(10))
```



Input Arguments

I — Input image

M-by-*N* matrix

Input image, specified as an *M*-by-*N* matrix. The input image must be a real, nonsparse value.

Data Types: `single` | `double` | `int16` | `uint8` | `uint16` | `logical`

Name-Value Pair Arguments

Specify optional pairs of arguments as `Name1=Value1, ..., NameN=ValueN`, where `Name` is the argument name and `Value` is the corresponding value. Name-value arguments must appear after other arguments, but the order of the pairs does not matter.

Example: `detectSIFTFeatures(I, ContrastThreshold=0.0133)` detects SIFT features with a contrast of less than 0.0133.

ContrastThreshold — Contrast threshold

0.0133 (default) | non-negative scalar in range [0,1]

Contrast threshold for selecting the strongest features, specified as a non-negative scalar in the range [0, 1]. The threshold is used to filter out weak features in low-contrast regions of the image. Increase the contrast threshold to decrease the number of returned features.

EdgeThreshold — Edge threshold

10.0 (default) | non-negative scalar

Edge threshold, specified as a non-negative scalar greater than or equal to 1. The threshold is used to filter out unstable edge-like features in the image that are susceptible to noise. Increase the edge threshold to decrease the number of features removed by filtering.

NumLayersInOctave — Number of layers in each octave

3 (default) | integer scalar

Number of layers in each octave, specified as an integer scalar greater than or equal to 1. The number of octaves is computed automatically from the image resolution. Increase the number of layers in each octave to detect larger features in the image.

Sigma — Sigma of the Gaussian

1.6 (default) | scalar

Sigma of the Gaussian, specified as a scalar. The sigma of the Gaussian is applied to the input image at the initial octave. Sigma values are typically in the range [1, 2]. Lower the sigma value if the image is blurry.

Output Arguments**points — SIFT features**

SIFTPoints object

SIFT features, returned as a SIFTPoints object. This object contains information about SIFT features detected in the 2-D grayscale image.

References

[1] Lowe, David G. "Distinctive Image Features from Scale-Invariant Keypoints." *International Journal of Computer Vision* 60, no. 2 (November 2004): 91--110.

Extended Capabilities**C/C++ Code Generation**

Generate C and C++ code using MATLAB® Coder™.

- Generates portable C code using a C++ compiler that links to OpenCV (Version 4.2.0) libraries. See "Portable C Code Generation for Functions That Use OpenCV Library".

See Also**Objects**

SIFTPoints | SURFPoints | MSERRegions | BRISKPoints | cornerPoints | ORBPoints | KAZEPoints

Functions

detectBRISKFeatures | detectFASTFeatures | detectKAZEFeatures | detectORBFeatures | detectMinEigenFeatures | detectHarrisFeatures | detectMSERFeatures | detectSURFFeatures | extractFeatures | matchFeatures

Introduced in R2021b

normalRotation

Compute transform for rotation of a normal to a plane

Syntax

```
normalRotation(model,referenceVector)
```

Description

`tform = normalRotation(model,referenceVector)` returns a `rigid3d` object `tform`, that specifies the transformation for a normal vector of a plane to the `referenceVector`. `model` is a `planeModel`. `referenceVector` is a 1-by-3 vector.

Examples

Transform Point Cloud

Construct a `velodyneFileReader` object.

```
veloReader = velodyneFileReader('lidarData_ConstructionRoad.pcap','HDL32E');
```

Read the first frame of lidar data.

```
frameNumber = 1;
ptCloud = readFrame(veloReader,frameNumber);
```

Find the ground plane.

```
maxDistance = 0.4;
referenceVector = [0 0 1];

groundPlane = pcfitsplane(ptCloud,maxDistance,referenceVector);
```

Transform the ground plane such that it is parallel to the X-Y plane.

```
tform = normalRotation(groundPlane,referenceVector);
```

Transform the point cloud.

```
ptCloudOut = pctransform(ptCloud,tform);
```

Display the original and transformed point cloud.

```
planeParams = groundPlane.Parameters * tform.T;
transformedPlane = planeModel(planeParams);
figure;
pcshowpair(ptCloudOut,ptCloud);
hold on;
plot(groundPlane, 'Color', 'magenta');
plot(transformedPlane, 'Color', 'green');
```

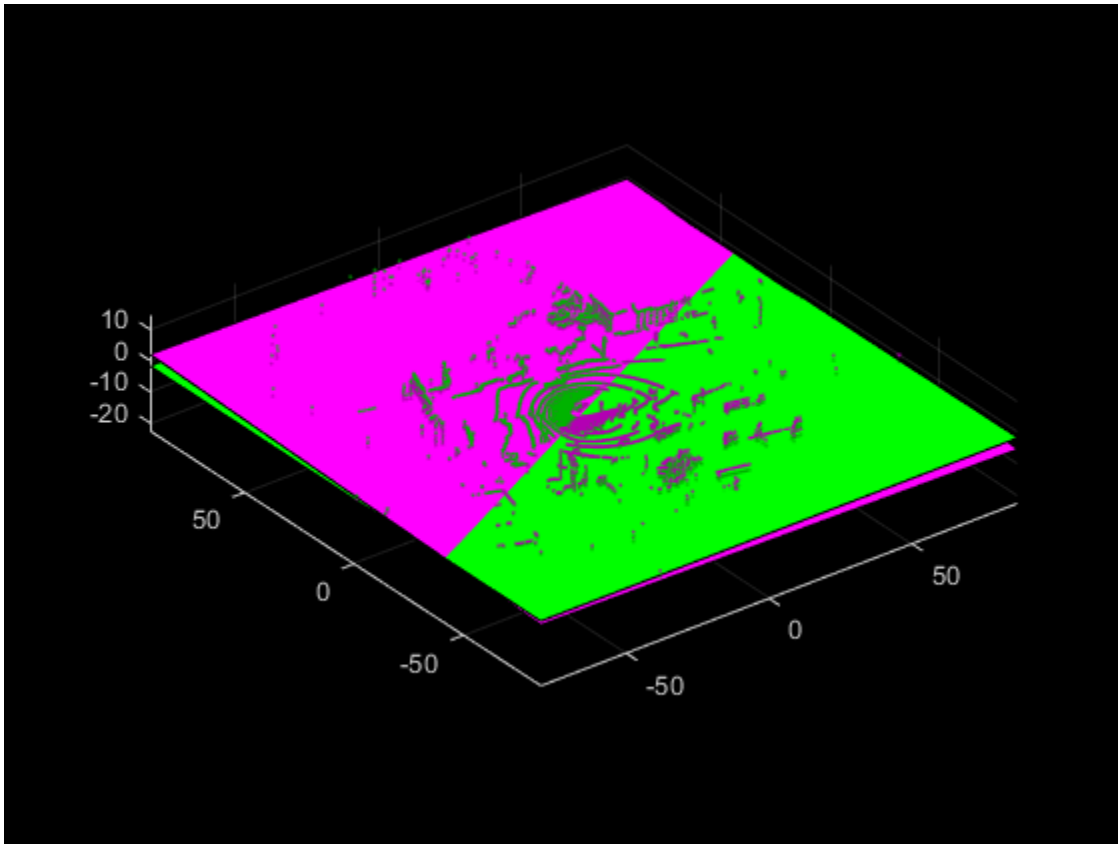

Input Arguments

model — Parametric plane model

plane model

Parametric plane model returned by `planeModel`.

referenceVector — Reference vector

1-by-3 vector

Reference vector, specified as a 1-by-3 vector.

See Also

Functions

`pcfitplane` | `pcregistercorr`

Objects

`pointCloud` | `rigid3d` | `planeModel`

Introduced in R2020b

showShape

Display shapes on image, video, or point cloud

Syntax

```
showShape(shape, position)
showShape( ____, Name, Value)
```

Description

`showShape(shape, position)` displays one or more instances of a shape `shape` in the current axes at the specified locations `position`.

`showShape(____, Name, Value)` specifies options using one or more name-value pair arguments. For example, `'Color', 'yellow'` specifies the color of the displayed shapes as yellow.

Examples

Display Detected Objects in Image

Read an image into the workspace.

```
I = imread('visionteam1.jpg');
```

Create an aggregate channel features (ACF) people detector.

```
detector = peopleDetectorACF()

detector =
    acfObjectDetector with properties:
        ModelName: 'inria-100x41'
        ObjectTrainingSize: [100 41]
        NumWeakLearners: 2048
```

Detect people in the image.

```
[bboxes, scores] = detect(detector, I);
```

Display the image with a labeled rectangle, including the associated detection score, around each detected person.

```
figure
imshow(I)
labels = "person:" + scores;
showShape('rectangle', bboxes, 'Label', labels)
```

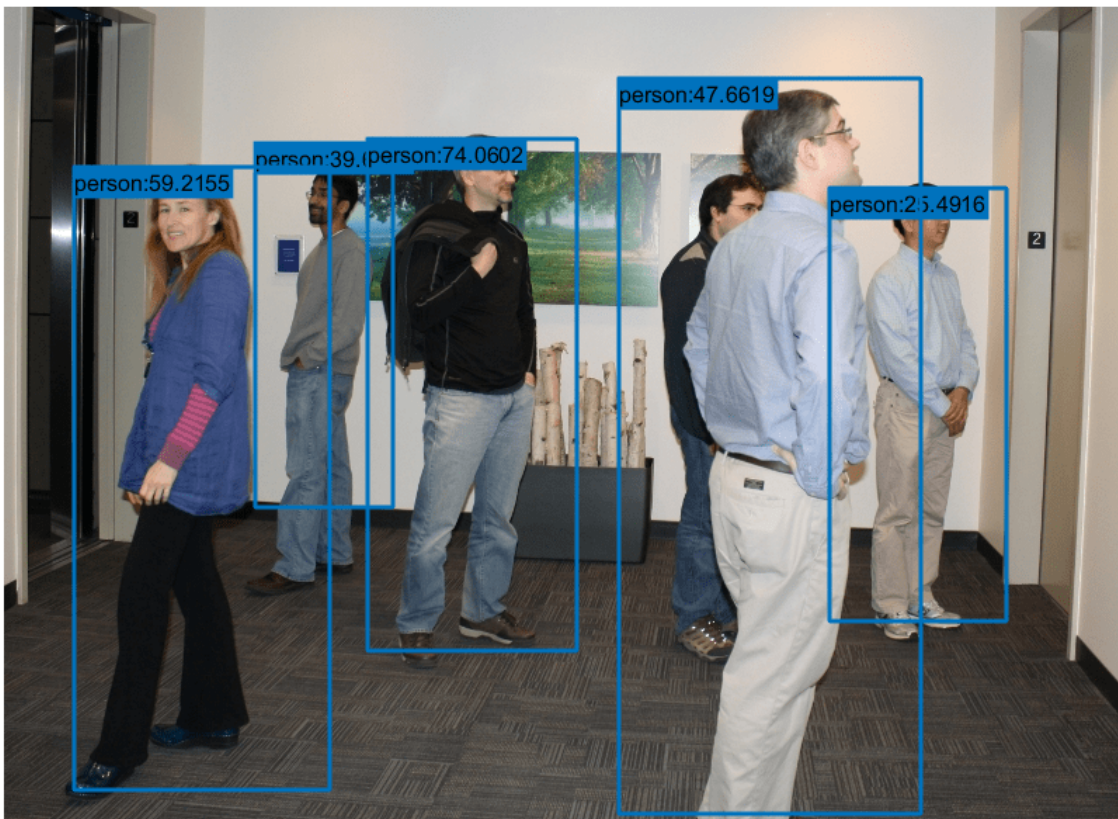

Display Bounding Box Around Object in Point Cloud

Read point cloud data into the workspace.

```
ptCloud = pcread('teapot.ply');
```

Display the point cloud data.

```
figure
pcshow(ptCloud)
xlabel('X')
ylabel('Y')
zlabel('Z')
```

Define a cuboid and display it in green with an opacity of 0.5.

```
pos = [0.3753 0 1.65 6 4 3 0 0 0];
showShape('cuboid',pos,'Color','green','Opacity',0.5)
```

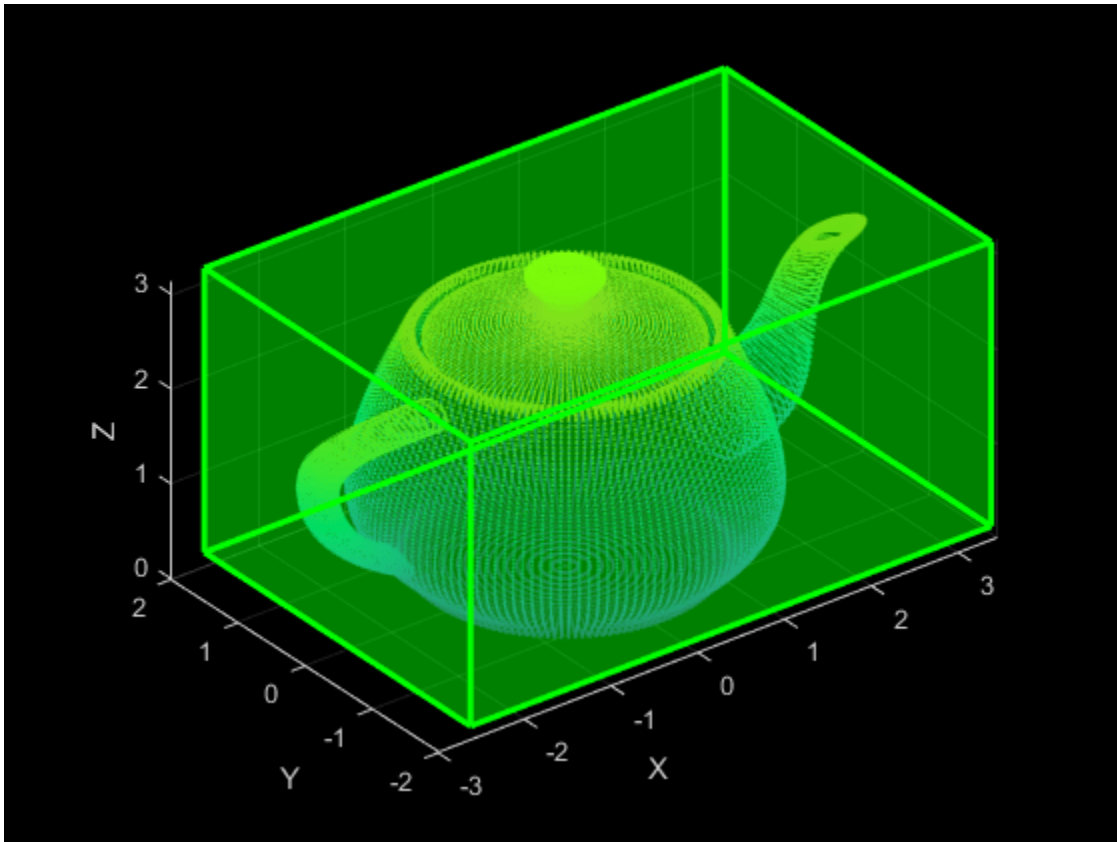

Visualize Cuboid Around Moving Object in Point Cloud Stream

Read point cloud data into the workspace.

```
ptCloud = pcread('teapot.ply');
```

Define a rotation matrix and 3-D transform to rotate the point cloud, and an associated cuboid, by 5 degrees.

```
rot = 5;
R = [ cosd(rot) sind(rot) 0 0; ...
      -sind(rot) cosd(rot) 0 0; ...
      0 0 1 0; ...
      0 0 0 1];
```

```
tform = affine3d(R);
```

Compute the x and y rendered limits of the point cloud to ensure that the point cloud is not clipped during rotation.

```
pcLimits = abs([ptCloud.XLimits ptCloud.YLimits]);
maxLimit = max(pcLimits);
```

Add an additional margin to the plot to prevent the cuboid from being clipped during rotation.

```
margin = 1;  
maxLimit = maxLimit + margin;
```

```
xlimits = [-maxLimit maxLimit];  
ylimits = [-maxLimit maxLimit];  
zlimits = ptCloud.ZLimits;
```

Create a player for visualizing the point cloud.

```
player = pcplayer(xlimits,ylimits,zlimits);
```

Customize the player axis labels.

```
xlabel(player.Axes,'X (m)');  
ylabel(player.Axes,'Y (m)');  
zlabel(player.Axes,'Z (m)');
```

Define a cuboid around the point cloud.

```
cuboidPosition = [0.3753 0 1.65 6 4 3 0 0 0];
```

Define the output view for a cuboid rotation. Use the same limits as the player so that the cuboid is not clipped. Then, display the rotated point cloud and cuboid.

```
gridSize = [1 1 1];  
ref = imref3d(gridSize,xlimits,ylimits,zlimits);  
  
for i = 1:round((360/rot))  
    % Rotate point cloud.  
    ptCloud = pctransform(ptCloud,tform);  
  
    % Rotate the cuboid.  
    cuboidPosition = bboxwarp(cuboidPosition,tform,ref);  
  
    % Show rotated point cloud data.  
    view(player,ptCloud)  
  
    % Show rotated cuboid.  
    showShape('cuboid',cuboidPosition, ...  
            'Parent',player.Axes, ...  
            'Color','green', ...  
            'Opacity',0.5)  
  
    % Use drawnow to synchronize point cloud and shape visualization.  
    drawnow  
end
```

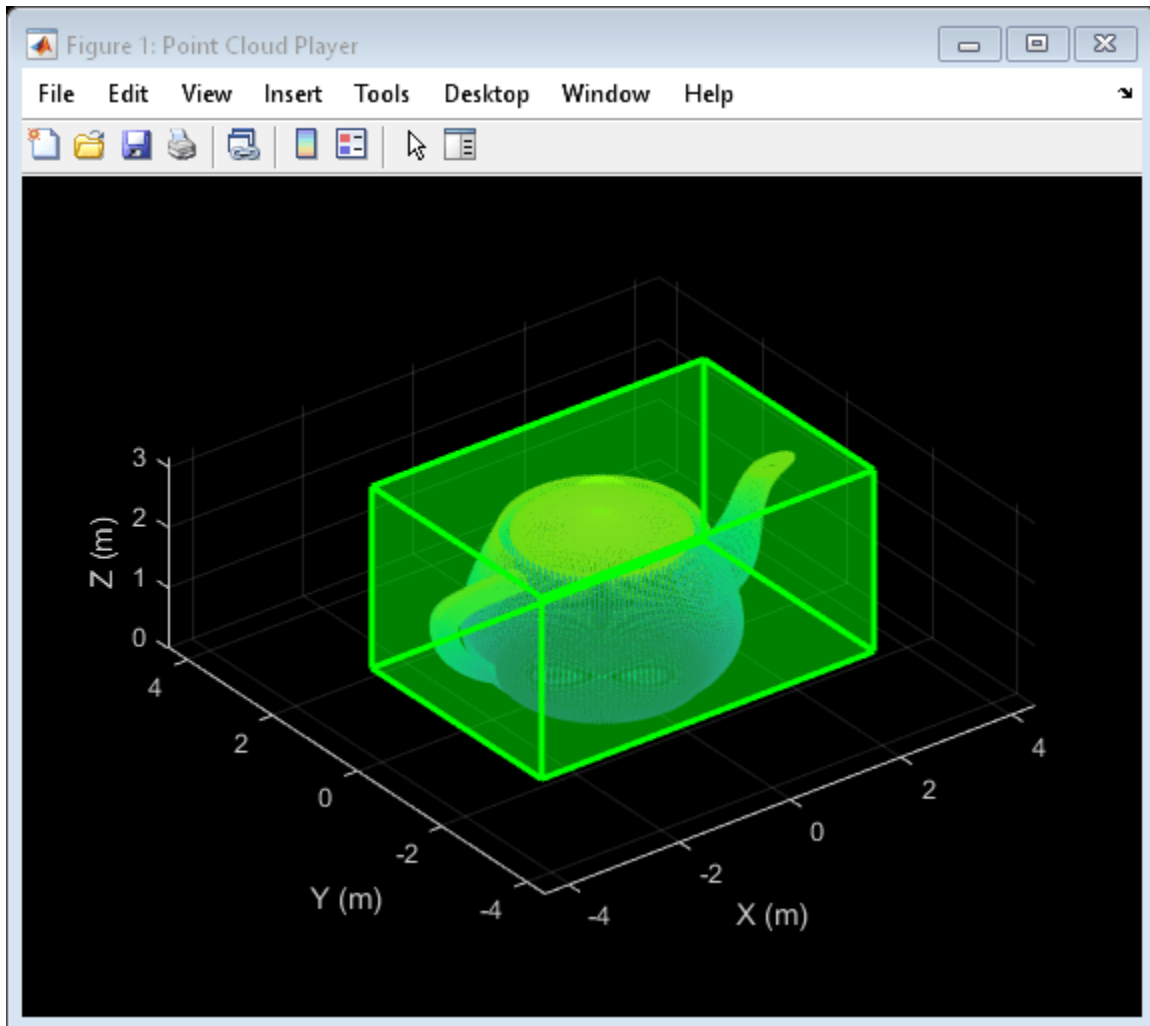
Input Arguments

shape — Type of shape

'line' | 'rectangle' | 'cuboid' | 'polygon' | 'circle'

Type of shape, specified as a character vector. The vector can be 'line', 'rectangle', 'cuboid', 'polygon', or 'circle'.

Data Types: string

position — Positions and sizes of shapes

M-by-4 matrix | *M*-by-5 matrix | *M*-by-9 matrix | *M*-by-2 matrix | *M*-by-3 matrix | cell array

Positions and sizes of shapes, specified according to the type of shapes, described in this table.

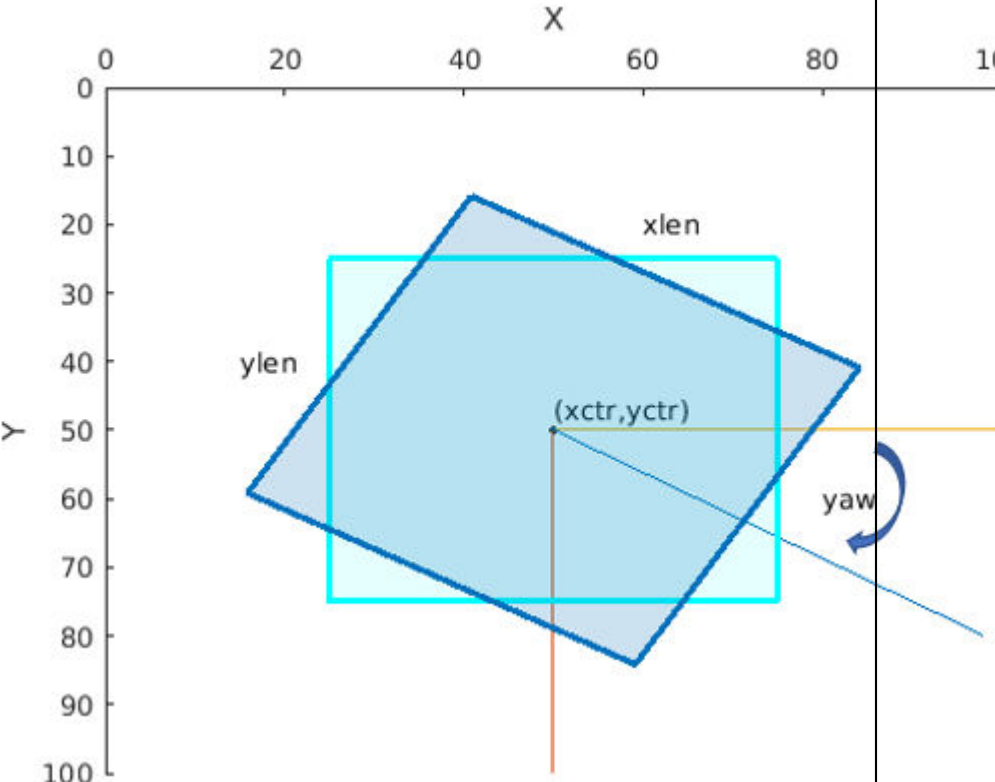
Bounding Box	Description
Axis-aligned rectangle	<p>Defined in pixel coordinates as an M-by-4 numeric matrix with rows of the form $[x\ y\ w\ h]$, where:</p> <ul style="list-style-type: none"> • M is the number of axis-aligned rectangles. • x and y specify the upper-left corner of the rectangle. • w specifies the width of the rectangle, which is its length along the x-axis. • h specifies the height of the rectangle, which is its length along the y-axis.
Rotated rectangle	<p>Defined in spatial coordinates as an M-by-5 numeric matrix with rows of the form $[xctr\ yctr\ xlen\ ylen\ yaw]$, where:</p> <ul style="list-style-type: none"> • M is the number of rotated rectangles. • $xctr$ and $yctr$ specify the center of the rectangle. • $xlen$ specifies the width of the rectangle, which is its length along the x-axis before rotation. • $ylen$ specifies the height of the rectangle, which is its length along the y-axis before rotation. • yaw specifies the rotation angle in degrees. The rotation is clockwise-positive around the center of the bounding box. 

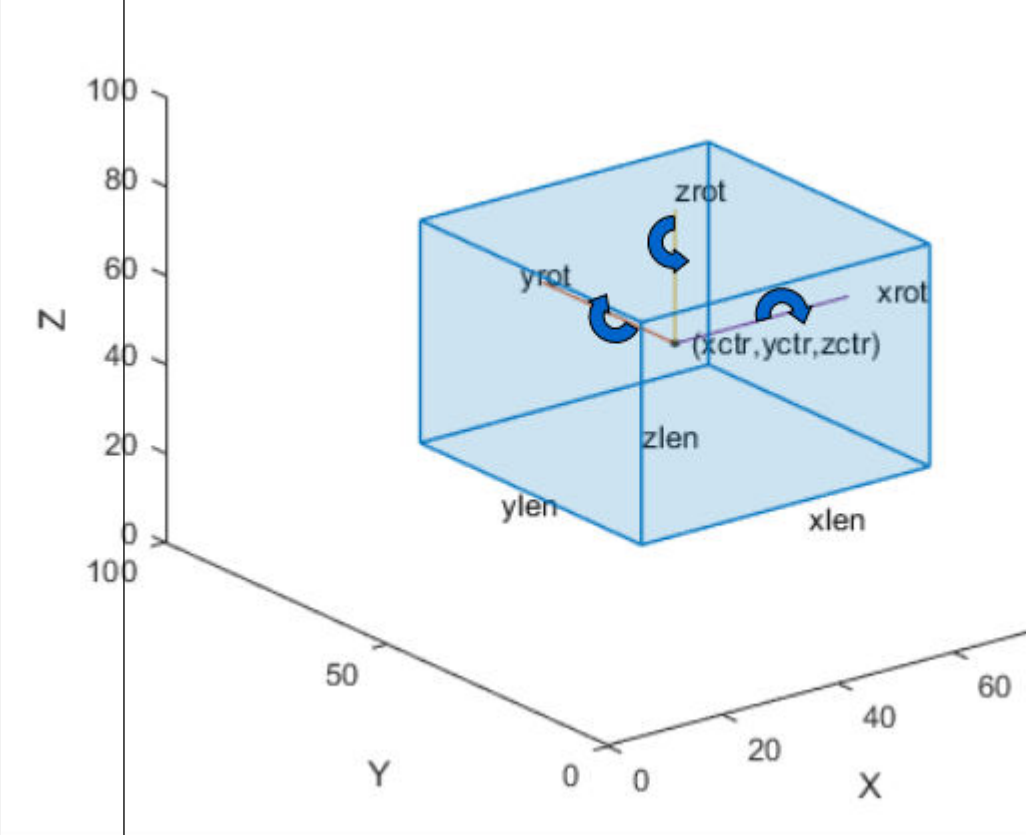
Bounding Box	Description
Cuboid	<p>Defined in spatial coordinates as an M-by-9 numeric matrix with rows of the form $[xctr\ yctr\ zctr\ xlen\ ylen\ zlen\ xrot\ yrot\ zrot]$, where:</p> <ul style="list-style-type: none"> • M is the number of cuboids. • $xctr$, $yctr$, and $zctr$ specify the center of the cuboid. • $xlen$, $ylen$, and $zlen$ specify the length of the cuboid along the x-axis, y-axis, and z-axis, respectively, before rotation. • $xrot$, $yrot$, and $zrot$ specify the rotation angles of the cuboid around the x-axis, y-axis, and z-axis, respectively. The $xrot$, $yrot$, and $zrot$ rotation angles are in degrees about the cuboid center. Each rotation is clockwise-positive with respect to the positive direction of the associated spatial axis. The function computes rotation matrices assuming ZYX order Euler angles $[xrot\ yrot\ zrot]$. <p>The figure shows how these values determine the position of a cuboid.</p> 
Circle	<p>Defined in spatial coordinates as an M-by-3 numeric matrix with rows of the form $[xctr\ yctr\ radius]$, where:</p> <ul style="list-style-type: none"> • M is the number of circles. • $xctr$ and $yctr$ specify the center of the circle. • $radius$ specifies the radius of the circle.

Bounding Box	Description
Line	<p>Defined in spatial coordinates as a P-by-2 matrix in which each row is an $[x\ y]$ endpoint or a 1-by-$2P$ vector of consecutive endpoints of the form $[x_1\ y_1\ x_2\ y_2\ \dots\ x_P\ y_P]$.</p> <ul style="list-style-type: none"> P is the number of endpoints. $[x_1\ y_1]$, $[x_2\ y_2]$, and $x_P\ y_P$ describe endpoints. <p>To specify several lines that contain different numbers of endpoints, you can use the cell array format described for a polygon.</p>
Polygon	<p>Defined in spatial coordinates as an M-by-1 cell array in which each cell contains an L-by-2 matrix of $[x\ y]$ vertex locations or a 1-by-$2L$ vector of consecutive vertex locations of the form $[x_1, y_1, x_2, y_2, \dots, x_L, y_L]$, where:</p> <ul style="list-style-type: none"> M is the number of polygons. $[x_1\ y_1]$, $[x_2\ y_2]$ describe vertex locations or endpoints. L is the number of vertices in a polygon or endpoints in a line. Each polygon or line can have different number of vertices or endpoints.

Name-Value Pair Arguments

Specify optional comma-separated pairs of **Name**, **Value** arguments. **Name** is the argument name and **Value** is the corresponding value. **Name** must appear inside quotes. You can specify several name and value pair arguments in any order as **Name1**, **Value1**, ..., **NameN**, **ValueN**.

Example: 'Color', 'yellow' specifies the color of the displayed shapes as yellow.

Label — Shape label

`[]` (default) | scalar | M -element vector | M -element cell array of character vectors

Shape label, specified as the comma-separated pair consisting of 'Label' and either a scalar, M -element vector, or an M -element cell array of character vectors.

If the input is a scalar value, then the function applies that same value as a label to each shape. If the input is an M -element vector or cell array, then the function applies each value to the corresponding shape, using the order in which the shapes are specified to the function. M is the number of shapes specified to the function.

Color — Shape color

`lines(1)` (default) | one or more RGB triplets | one or more color names or short color names

Shape color, specified as the comma-separated pair consisting of 'Color' and one or more RGB triplets, or one or more color names or short color names. To use the same color for all shapes, specify a single (MATLAB ColorSpec) color name or a single RGB triplet.

To use a different color for each shape, specify an M -element vector or cell array of color names or an M -by-3 numeric matrix in which each row is an RGB triplet. M is the number of shapes specified to the function.

Opacity — Opacity of shape fill

`0` (default) | M -element vector of values in the range `[0 1]`

Opacity of the shape fill, specified as the comma-separated pair consisting of `'Opacity'` and an M -element vector of numeric values in the range $[0\ 1]$. To use the same opacity for all shapes, specify a scalar opacity value. For a fully opaque shape fill, set `'Opacity'` to 1.

Parent — Output axes

`gca` (default) | Axes graphics object

Output axes, specified as the comma-separated pair consisting of `'Parent'` and an Axes Properties graphics object.

LineColor — Border line color

`'auto'` (default) | one or more RGB triplets | one or more color names or short color names

Border line color, specified as the comma-separated pair consisting of `'Color'` and one or more RGB triplets, or one or more color names or short color names. To use the same color for all border lines, specify a single (MATLAB `ColorSpec`) color name or a single RGB triplet.

To use a different color for each shape, specify an M -element vector or cell array of color names or an M -by-3 numeric matrix in which each row is an RGB triplet. M is the number of shapes specified to the function.

LineWidth — Border line width

`'auto'` (default) | positive scalar integer | M -element vector of positive values

Border line width in pixels, specified as the comma-separated pair consisting of `'LineWidth'` and a positive scalar integer or an M -element vector of positive scalar integers. To use the same line width for all shapes, specify a positive scalar integer. Otherwise, specify an M -element vector of positive integers, where M is the number of shapes specified to the function.

LineOpacity — Border line opacity of shape fill

0 (default) | M -element vector of values in the range $[0\ 1]$

Border line opacity of the shape fill, specified as the comma-separated pair consisting of `'Opacity'` and an M -element vector of numeric values in the range $[0\ 1]$. To use the same opacity for the border line of all shapes, specify a scalar opacity value. For a fully opaque border line, set `'Opacity'` to 1.

LabelTextColor — Label text color

`'black'` (default) | one or more RGB triplets | one or more color names or short color names

Label text color, specified as the comma-separated pair consisting of `'Color'` and one or more RGB triplets, or one or more color names or short color names. To use the same color for the text of all labels, specify a single (MATLAB `ColorSpec`) color name or a single RGB triplet.

To use a different color for text of each label, specify an M -element vector or cell array of color names or an M -by-3 numeric matrix in which each row is an RGB triplet. M is the number of labels specified to the function.

LabelOpacity — Label opacity

0 (default) | M -element vector of values in the range $[0\ 1]$

Label opacity, specified as the comma-separated pair consisting of `'Opacity'` and an M -element vector of numeric values in the range $[0\ 1]$. To use the same opacity for all labels, specify a scalar opacity value. For a fully opaque label, set `'Opacity'` to 1.

LabelFont — Label font

'Helvetica' (default) | 'FixedWidth' | supported font

Label font, specified as the comma-separated pair consisting of 'LabelFont' and 'FixedWidth' or a font that your system supports. To display and print text properly, you must select a font that your system supports. If you select an unsupported font, the function returns an error. If you specify 'FixedWidth', the function uses the font specified by the FixedWidthFont property of the Root Properties object. The fixed-width font relies on the value of `get(0, 'FixedWidthFontName')`.

LabelFontSize — Label font size

12 (default) | positive scalar

Label font size in point units, specified as the comma-separated pair consisting of 'LabelFontSize' and a positive scalar.

See Also

`insertObjectAnnotation` | `insertObjectMask` | `insertMarker` | `insertText` | `insertShape` | `pcplayer` | `pcshow` | `imshow`

Topics

“Draw Markers on an Image” on page 3-637

“Insert Numbers and Text on Image” on page 3-658

“Choose Function to Visualize Detected Objects”

Introduced in R2020b

pregistercorr

Register two point clouds using phase correlation

Syntax

```
tform = pregistercorr(moving, fixed, gridSize, gridStep)
[tform, rmse] = pregistercorr( ___ )
[ ___ , peak] = pregistercorr( ___ )
[ ___ ] = pregistercorr( ___ , Name, Value)
```

Description

`tform = pregistercorr(moving, fixed, gridSize, gridStep)` computes the rigid transformation that registers the moving point cloud, `moving`, to the fixed point cloud, `fixed` using a phase correlation algorithm.

The function performs registration by first converting both point clouds to a 2-D occupancy grid in the *X-Y* plane with center at the origin (0,0,0). The occupancy of each grid cell is determined using the *Z*-coordinate values of points within the grid.

`[tform, rmse] = pregistercorr(___)` additionally returns the root mean square error of the Euclidean distance between the registered point clouds.

`[___ , peak] = pregistercorr(___)` additionally returns the peak correlation value of the phase difference between the two occupancy grids.

`[___] = pregistercorr(___ , Name, Value)` specifies options using one or more name-value arguments in addition to the input arguments in previous syntaxes. For example, `'Window', false` sets the `Window` name-value argument to `false`.

Examples

Register Lidar Moving Point Cloud to Fixed Point Cloud

Read data from a Velodyne packet capture (PCAP) file into the workspace.

```
veloReader = velodyneFileReader('lidarData_ConstructionRoad.pcap', 'HDL32E');
```

Read a fixed and a moving point cloud from frames of the lidar data.

```
frameNumber = 1;
skipFrame    = 5;
fixed        = readFrame(veloReader, frameNumber);
moving       = readFrame(veloReader, frameNumber + skipFrame);
```

Find the ground planes for both the moving and the fixed point clouds. Set the maximum distance in meters.

```
maxDistance = 0.4;
referenceVector = [0 0 1];
```

```
groundMoving = pcfitplane(moving,maxDistance,referenceVector);
groundFixed = pcfitplane(fixed,maxDistance,referenceVector);
```

Transform the point clouds so that their ground planes are parallel to the X-Y plane.

```
tformMoving = normalRotation(groundMoving,referenceVector);
tformFixed = normalRotation(groundFixed,referenceVector);
```

```
movingCorrected = pctransform(moving,tformMoving);
fixedCorrected = pctransform(fixed,tformFixed);
```

Register the moving point cloud against the fixed point cloud. Set the occupancy grid size to 100-by-100 meters and the size of each grid cell to 0.5-by-0.5 meters.

```
gridSize = 100;
gridStep = 0.5;
```

```
tform = pcregistercorr(movingCorrected,fixedCorrected,gridSize,gridStep);
```

Transform the moving point cloud using an estimated rigid transformation.

```
combinedTform = rigid3d(tform.T * tformMoving.T * tformFixed.T);
movingReg = pctransform(moving,combinedTform);
```

Visualize the registration.

```
figure
subplot(121)
pcshowpair(moving,fixed)
title('Before Registration')
view(2)
```

```
subplot(122)
pcshowpair(movingReg,fixed)
title('After Registration')
view(2)
```

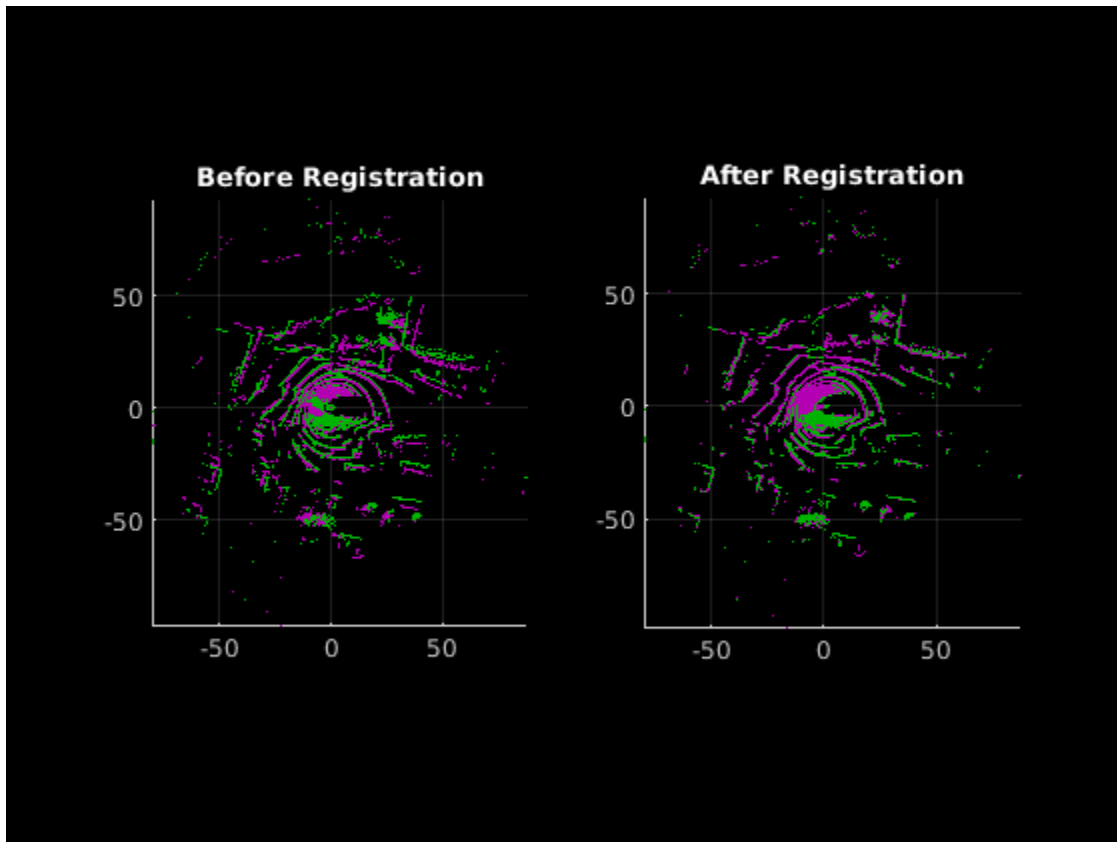
Input Arguments

moving — Moving point cloud

`pointCloud` object

Moving point cloud, specified as a `pointCloud` object.

fixed — Fixed point cloud

`pointCloud` object

Fixed point cloud, specified as a `pointCloud` object.

gridSize — Size of square occupancy grid

scalar

Size of square occupancy grid, specified as a scalar value in world units. The occupancy grid has both width and height equal to this value. The center is at the origin (0, 0, 0).

gridStep — Size of each grid cell

scalar

Size of each grid cell, specified as a scalar value in world units.

Name-Value Pair Arguments

Example: `'zlim', [0 3]` sets the Z-axis lower limit to 0 and the upper limit to 3.

zLim — Z-axis limit

[0 3] (default) | vector of form [zmin zmax]

Z-axis limit to compute the occupancy of a grid cell, specified as a vector of the form [zmin zmax], where *zmin* and *zmax* are numeric scalars. The function scales points with a Z-axis value from *zmin* to *zmax* to probabilities in the range [0, 1]. Values less than *zmin* are assigned an occupancy value of 0. Values greater than *zmax* are assigned an occupancy value of 1.

Window — Logical to specify whether to use windowing

true (default) | false

Logical to specify whether to use windowing to suppress spectral leakage effects in the frequency domain. When you set `Window` to `true`, the function uses a Blackman window to increase the stability of registration results. If the common features that will be aligned in the occupancy grids are oriented along the edges, then setting `Window` to `false` could provide superior registration results.

Output Arguments

tform — Rigid transformation

rigid3d object

Rigid transformation, returned as a `rigid3d` object. The rigid transformation registers a moving point cloud to a fixed point cloud. The `rigid3d` object describes the rigid 3-D transform.

rmse — Root mean square error

positive scalar

Root mean square error, returned as the Euclidean distance between the aligned point clouds.

peak — Peak correlation value

scalar value

Peak correlation value of the phase difference between the two occupancy grids, returned as a scalar value. A peak value less than 0.03 indicates a poor registration result.

Tips

- The phase correlation method is best used to register point clouds when the transformation can be described by a translation in the X-Y plane and a rotation around the Z-axis. For example, a ground vehicle with a horizontally mounted lidar moving on a flat surface.
- The phase correlation algorithm expects motion to be exclusively along the X-Y plane, as with the ground plane. If motion is not exactly in the X-Y plane, you can use the `normalRotation` function to transform the point clouds. For example, in vehicular motion, you can reduce the effects of vehicle suspension or surface features such as potholes and speed bumps by using the `normalRotation` function.
- Increasing the size of the occupancy grid increases the computational demands of this function. You can control the size of the occupancy grid by modifying the `gridSize` and `gridStep` arguments.
- If you obtain poor registration results and the `peak` correlation value is less than 0.03, try setting the `Window` argument to `false`.

References

- [1] Dimitrievski, Martin, David Van Hamme, Peter Veelaert, and Wilfried Philips. "Robust Matching of Occupancy Maps for Odometry in Autonomous Vehicles." In *Proceedings of the 11th Joint Conference on Computer Vision, Imaging and Computer Graphics Theory and Applications*, 626-33. Rome, Italy: SCITEPRESS - Science and Technology Publications, 2016.

See Also

Functions

pcregisterndt | pcregistercpd | pctransform | pcshow | pcshowpair | pcdsample | pcfitsphere | pcdnoise | pcmerge

Objects

pointCloud | rigid3d

Topics

"3-D Point Cloud Registration and Stitching"
"Implement Point Cloud SLAM in MATLAB"

Introduced in R2020b

scanContextDistance

Distance between scan context descriptors

Syntax

```
dist = scanContextDistance(descriptor1,descriptor2)
```

Description

`dist = scanContextDistance(descriptor1,descriptor2)` computes the normalized distance between scan context descriptors. Determine loop closure candidates using the computed distance.

A scan context descriptor is a 2-D global feature descriptor for a point cloud that can be used to detect loop closures. To extract a scan context descriptor from a point cloud, use the `scanContextDescriptor` function.

Examples

Extract and Compare Scan Context Descriptors of Point Clouds

Create a Velodyne® packet capture (PCAP) file reader.

```
veloReader = velodyneFileReader('lidarData_ConstructionRoad.pcap','HDL32E');
```

Read the 1st, 2nd, and 100th scan into the workspace.

```
ptCloud1 = readFrame(veloReader,1);
ptCloud2 = readFrame(veloReader,2);
ptCloud100 = readFrame(veloReader,100);
```

Extract scan context descriptors from each of the point clouds.

```
descriptor1 = scanContextDescriptor(ptCloud1);
descriptor2 = scanContextDescriptor(ptCloud2);
descriptor100 = scanContextDescriptor(ptCloud100);
```

Compute the descriptor distance between the 1st and 2nd scan context descriptors, and between the 1st and 100th scan context descriptors.

```
dist1to2 = scanContextDistance(descriptor1,descriptor2);
dist1to100 = scanContextDistance(descriptor1,descriptor100);
```

Display the scan context descriptor distances.

```
disp("Descriptor distance from frame 1 to 2 : " + num2str(dist1to2))
Descriptor distance from frame 1 to 2 : 0.087646
disp("Descriptor distance from frame 1 to 100 : " + num2str(dist1to100))
Descriptor distance from frame 1 to 100 : 0.32427
```

Input Arguments

descriptor1 — Scan context descriptor of point cloud

M-by-*N* matrix

Scan context descriptor of point cloud, specified as an *M*-by-*N* matrix. To ensure an accurate distance measurement, use the same radial range when extracting this descriptor as for `descriptor2`.

Data Types: `single` | `double`

descriptor2 — Scan context descriptor of point cloud

M-by-*N* matrix

Scan context descriptor of point cloud, specified as an *M*-by-*N* matrix. To ensure an accurate distance measurement, use the same radial range when extracting this descriptor as for `descriptor1`.

Data Types: `single` | `double`

Output Arguments

dist — Distance between scan context descriptors

scalar in the range [0, 1]

Distance between the scan context descriptors, returned as a scalar in the range [0, 1]. A small value indicates that the scan contexts are likely to belong to the same location, and are loop closure candidates.

Data Types: `single` | `double`

Algorithms

- The function computes the distance between scan context descriptors using a modified cosine distance and normalizes it to the range [0 to 1).

Extended Capabilities

C/C++ Code Generation

Generate C and C++ code using MATLAB® Coder™.

See Also

Objects

`pointCloud`

Functions

`scanContextDescriptor`

Topics

“Implement Point Cloud SLAM in MATLAB”

Introduced in R2020b

scanContextDescriptor

Extract scan context descriptor from point cloud

Syntax

```
descriptor = scanContextDescriptor(ptCloud)
descriptor = scanContextDescriptor(ptCloud,Name,Value)
```

Description

`descriptor = scanContextDescriptor(ptCloud)` extracts a scan context descriptor from a point cloud, `ptCloud`.

A scan context descriptor is a 2-D global feature descriptor of a point cloud that can be used to detect loop closures. The function computes the descriptor by first binning points from a 3-D point cloud scan into concentric radial and azimuthal bins, and then selecting the maximum *z*-height of points in each bin.

`descriptor = scanContextDescriptor(ptCloud,Name,Value)` specifies options using one or more name-value pair arguments.

Examples

Extract and Compare Scan Context Descriptors of Point Clouds

Create a Velodyne® packet capture (PCAP) file reader.

```
veloReader = velodyneFileReader('lidarData_ConstructionRoad.pcap','HDL32E');
```

Read the 1st, 2nd, and 100th scan into the workspace.

```
ptCloud1 = readFrame(veloReader,1);
ptCloud2 = readFrame(veloReader,2);
ptCloud100 = readFrame(veloReader,100);
```

Extract scan context descriptors from each of the point clouds.

```
descriptor1 = scanContextDescriptor(ptCloud1);
descriptor2 = scanContextDescriptor(ptCloud2);
descriptor100 = scanContextDescriptor(ptCloud100);
```

Compute the descriptor distance between the 1st and 2nd scan context descriptors, and between the 1st and 100th scan context descriptors.

```
dist1to2 = scanContextDistance(descriptor1,descriptor2);
dist1to100 = scanContextDistance(descriptor1,descriptor100);
```

Display the scan context descriptor distances.

```
disp("Descriptor distance from frame 1 to 2 : " + num2str(dist1to2))
```

```
Descriptor distance from frame 1 to 2 : 0.087646
disp("Descriptor distance from frame 1 to 100 : " + num2str(dist1to100))
Descriptor distance from frame 1 to 100 : 0.32427
```

Input Arguments

ptCloud — Point cloud object

pointCloud object

Point cloud object, specified as pointCloud object.

Name-Value Pair Arguments

Specify optional comma-separated pairs of `Name`, `Value` arguments. `Name` is the argument name and `Value` is the corresponding value. `Name` must appear inside quotes. You can specify several name and value pair arguments in any order as `Name1, Value1, ..., NameN, ValueN`.

Example: `'NumBins', [20 60]` sets the number of radial bins to 20, and the number of azimuthal bins to 60.

NumBins — Number of concentric radial and angular bins

`[20 60]` (default) | vector of form `[numRadialBins numAzimuthalBins]`

Number of concentric radial and angular bins, specified as the comma-separated pair consisting of `'NumBins'` and a vector of the form `[numRadialBins numAzimuthalBins]`, where `numRadialBins` is a positive integer that specifies the number of concentric radial bins and `numAzimuthalBins` specifies the number of concentric angular bins. To extract more compact descriptors, you can decrease the number of bins, but this reduces the discriminative power.

MinPointsPerBin — Minimum number of points to include bin

5 (default) | scalar

Minimum number of points for a bin to be included in descriptor, specified as the comma-separated pair consisting of `'MinPointsPerBin'` and a positive integer. Bins that do not contain the minimum number of points are not included in the descriptor. For these bins, the function returns `NaN`. To reduce the chances for noise to be included as a bin, increase this value.

SensorOrigin — Sensor origin

`[0 0]` (default) | two-element vector

Sensor origin, specified as the comma-separated pair consisting of `'SensorOrigin'` and a two-element vector. The elements set the x - and y -axis coordinate points, respectively, of the sensor origin in world units. The function centers the bins around the origin of the scan.

RadialRange — Radial bounds of descriptor

full spatial extent of point cloud (default) | two-element vector

Radial bounds of the descriptor used when binning points, specified as the comma-separated pair consisting of `'RadialRange'` and a two-element vector in the form `[rmin, rmax]`. Use this name-value argument to restrict the spatial bounds covered by the descriptor.

Output Arguments

descriptor — Scan context descriptor

M-by-*N* matrix

Scan context descriptor, returned as an *M*-by-*N* matrix, where *M* and *N* are the number of concentric radial and angular bins, respectively, in the descriptor. These are specified by the `NumBins` property.

The function returns inherits the data type of the `Location` property of the input point cloud.

Data Types: `single` | `double`

Tips

- The scan context descriptor function assumes that the sensor is mounted roughly horizontally and that the input point cloud is in the sensor coordinate system.
- To determine loop closure candidates, compare the distance between two scan context descriptors using the `scanContextDistance` function.

Extended Capabilities

C/C++ Code Generation

Generate C and C++ code using MATLAB® Coder™.

See Also

Objects

`pointCloud`

Functions

`scanContextDistance`

Topics

“Implement Point Cloud SLAM in MATLAB”

Introduced in R2020b

pcalign

Align an array point clouds

Syntax

```
ptCloudOut = pcalign(ptClouds,tforms)
ptCloudOut = pcalign(ptClouds,tforms,gridStep)
```

Description

`ptCloudOut = pcalign(ptClouds,tforms)` aligns an array of point clouds, `ptClouds`, into one point cloud by using the specified transformations `tforms`.

`ptCloudOut = pcalign(ptClouds,tforms,gridStep)` applies a box grid filter, with 3-D boxes of the specified size `gridStep`, to the aligned point cloud. Points within the same box are merged to a single point in the output, with averaged `Color`, `Normal`, and `Intensity` properties.

Examples

Align Point Clouds from View Set

Load a point cloud view set into the workspace.

```
data = load('vSetPointClouds.mat');
vSet = data.vSet;
```

Extract the point clouds and their absolute poses from the view set.

```
ptClouds = vSet.Views.PointCloud;
tforms = vSet.Views.AbsolutePose;
```

Align the point clouds using their absolute poses, and apply a 3-D box filter of size 1 to the aligned point cloud.

```
gridStep = 1;
ptCloudMap = pcalign(ptClouds,tforms,gridStep);
```

Display the aligned point cloud map.

```
pcshow(ptCloudMap)
hold on
plot(vSet)
```

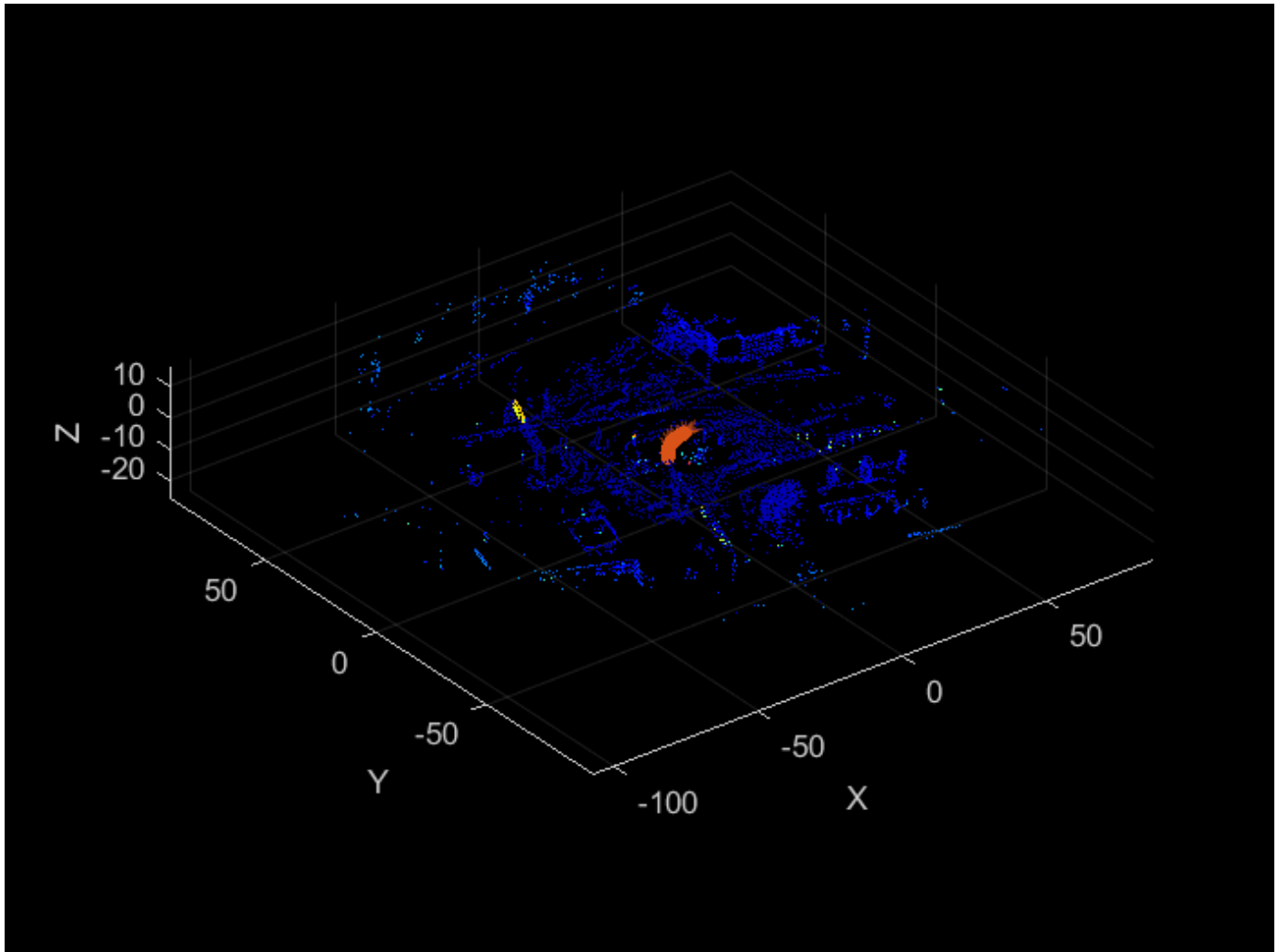

Input Arguments

ptClouds — Point clouds

pointCloud array

Point clouds, specified as a pointCloud array.

tforms — 3-D rigid or affine geometric transformations

M-by-1 rigid3d array | *M*-by-1 affine3d array

3-D rigid or affine geometric transformations, specified as an *M*-by-1 rigid3d array or an *M*-by-1 affine3d array. The tforms argument must contain the same number of elements as the ptClouds argument.

gridStep — Size of 3-D box for grid filter

positive scalar

Size of the 3-D box for the grid filter, specified as a positive scalar. Increasing the value of `gridStep` can reduce memory usage by merging more points, but it can also reduce the amount of detail captured.

Data Types: `single` | `double`

Output Arguments

ptCloudOut — Aligned point cloud

`pointCloud` object

Aligned point cloud, returned as a `pointCloud` object.

Tips

- If the input point clouds do not all have an assigned value for a property, the function does not assign a value for that property in the returned point cloud. For example, if some of the input point clouds have values for the `Color` property but another one does not, then the function does not return a value for the `Color` property of `ptCloudOut`.
- The function filters out points with `NaN` or `Inf` values.

Extended Capabilities

C/C++ Code Generation

Generate C and C++ code using MATLAB® Coder™.

See Also

Objects

`pointCloud` | `planeModel` | `affine3d` | `rigid3d` | `pcviewset`

Functions

`pcplayer` | `pcshow` | `pcwrite` | `pcread` | `pcmerge` | `pcdownsample` | `pcfitplane` | `pcdenoise` | `pcregistericp` | `pccat`

Topics

“3-D Point Cloud Registration and Stitching”

Introduced in R2020b

pccat

Concatenate 3-D point cloud array

Syntax

```
ptCloudOut = pccat(ptClouds)
```

Description

`ptCloudOut = pccat(ptClouds)` concatenates a 3-D point cloud array, `ptClouds`. `ptCloudOut` contains the `Location`, `Color`, `Normal`, and `Intensity` property values of all the concatenated point clouds.

Examples

Combine Sequence of Point Clouds

Read a sequence of aligned point clouds.

```
filePath = fullfile(toolboxdir('vision'),'visiondata','pcdmapseq');  
fileDS = fileDatastore(filePath,'ReadFcn',@pcread,'UniformRead',true);  
ptClouds = readall(fileDS);
```

Concatenate point clouds into a single point cloud.

```
ptCloudOut = pccat(ptClouds);
```

Display concatenated point cloud.

```
pcshow(ptCloudOut)
```

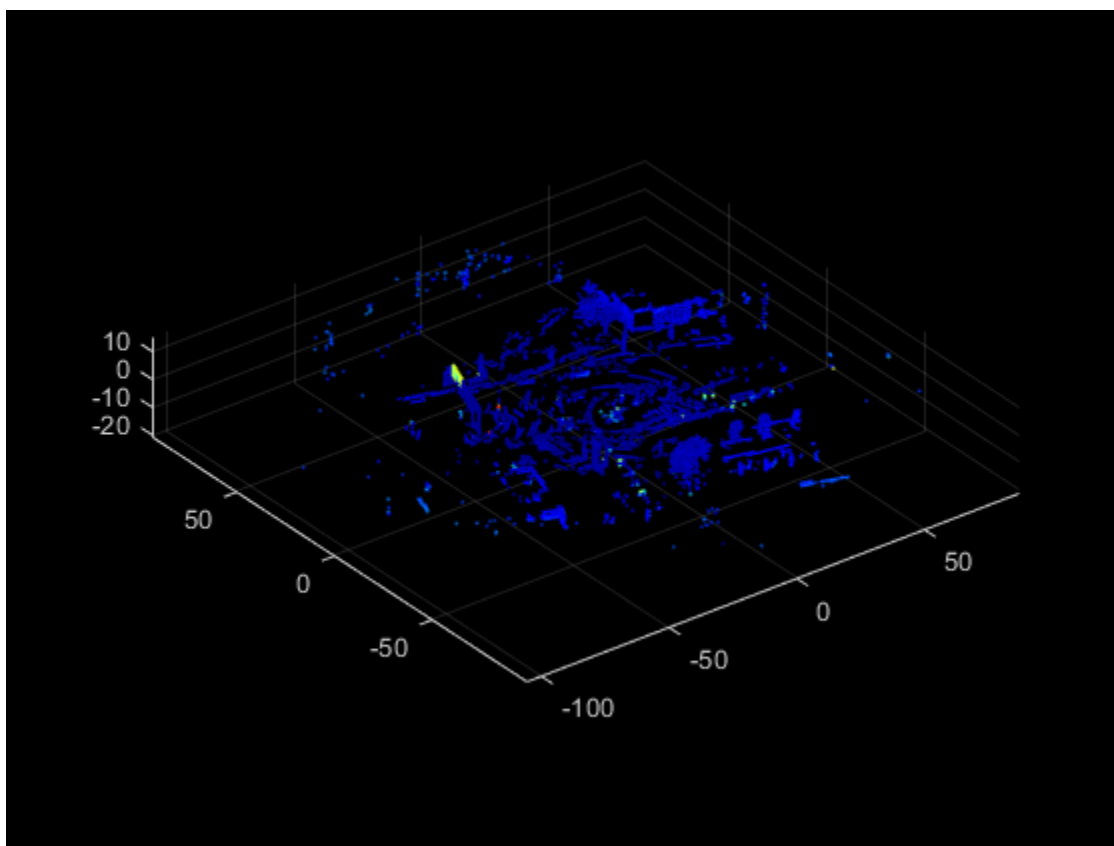

Input Arguments

ptClouds — Point clouds

M-by-1 `pointCloud` array

Point cloud objects, specified as an *M*-by-1 `pointCloud` array.

Output Arguments

ptCloudOut — Concatenated point cloud

`pointCloud` object

Concatenated point cloud, returned as a `pointCloud` object. `ptCloudOut` contains the `Location`, `Color`, `Normal`, and `Intensity` property values of all the concatenated point clouds.

Tips

- If the input point clouds do not all have an assigned value for a property, the function does not assign a value for that property in the returned point cloud. For example, if some of the input point clouds have values for the `Color` property but another one does not, then the function does not return a value for the `Color` property of `ptCloudOut`.
- The function filters out points with `NaN` or `Inf` values.

Extended Capabilities

C/C++ Code Generation

Generate C and C++ code using MATLAB® Coder™.

- All point clouds in the input point cloud array must be either organized or unorganized point clouds.

See Also

Objects

`pointCloud`

Functions

`pcalign` | `pcmerge`

Topics

“3-D Point Cloud Registration and Stitching”

Introduced in R2020b

readAprilTag

Detect and estimate pose for AprilTag in image

Syntax

```
[id,loc] = readAprilTag(I)
[id,loc] = readAprilTag(I,tagFamily)
[ ____,pose] = readAprilTag( ____,intrinsic,tagSize)
[ ____,detectedFamily] = readAprilTag( ____ )
```

Description

`[id,loc] = readAprilTag(I)` detects AprilTags in the input image `I` and returns the locations and IDs associated with the tags.

`[id,loc] = readAprilTag(I,tagFamily)` detects AprilTags of only the specified families, `tagFamily`.

`[____,pose] = readAprilTag(____,intrinsic,tagSize)` returns the poses of the tags with respect to the specified camera intrinsic parameters, `intrinsic` and size of the tags `tagSize` in addition to any combination of arguments in previous syntaxes.

`[____,detectedFamily] = readAprilTag(____)` returns the recognized AprilTag families, `detectedFamily`.

Examples

Detect AprilTags in Image

Read an image into the workspace.

```
I = imread("aprilTagsMulti.jpg");
```

Specify the AprilTag formats to search in the image.

```
tagFamily = ["tag36h11","tagCircle21h7","tagCircle49h12","tagCustom48h12","tagStandard41h12"];
```

Detect tags and tag locations in the image, and read the tag IDs.

```
[id,loc,detectedFamily] = readAprilTag(I,tagFamily);
```

```
for idx = 1:length(id)
    % Display the ID and tag family
    disp("Detected Tag ID, Family: " + id(idx) + ", " ...
        + detectedFamily{idx});

    % Insert markers to indicate the locations
    markerRadius = 8;
    numCorners = size(loc,1);
    markerPosition = [loc(:,:,idx), repmat(markerRadius,numCorners,1)];
```

```
I = insertShape(I, "FilledCircle", markerPosition, "Color", "red", "Opacity", 1);  
end
```

```
Detected Tag ID, Family: 30, tag36h11  
Detected Tag ID, Family: 32, tagCircle21h7  
Detected Tag ID, Family: 98, tagStandard41h12  
Detected Tag ID, Family: 195, tagCustom48h12  
Detected Tag ID, Family: 884, tagCircle49h12
```

Display the image with markers to indicate the corner locations of the detected tags.

```
imshow(I)
```

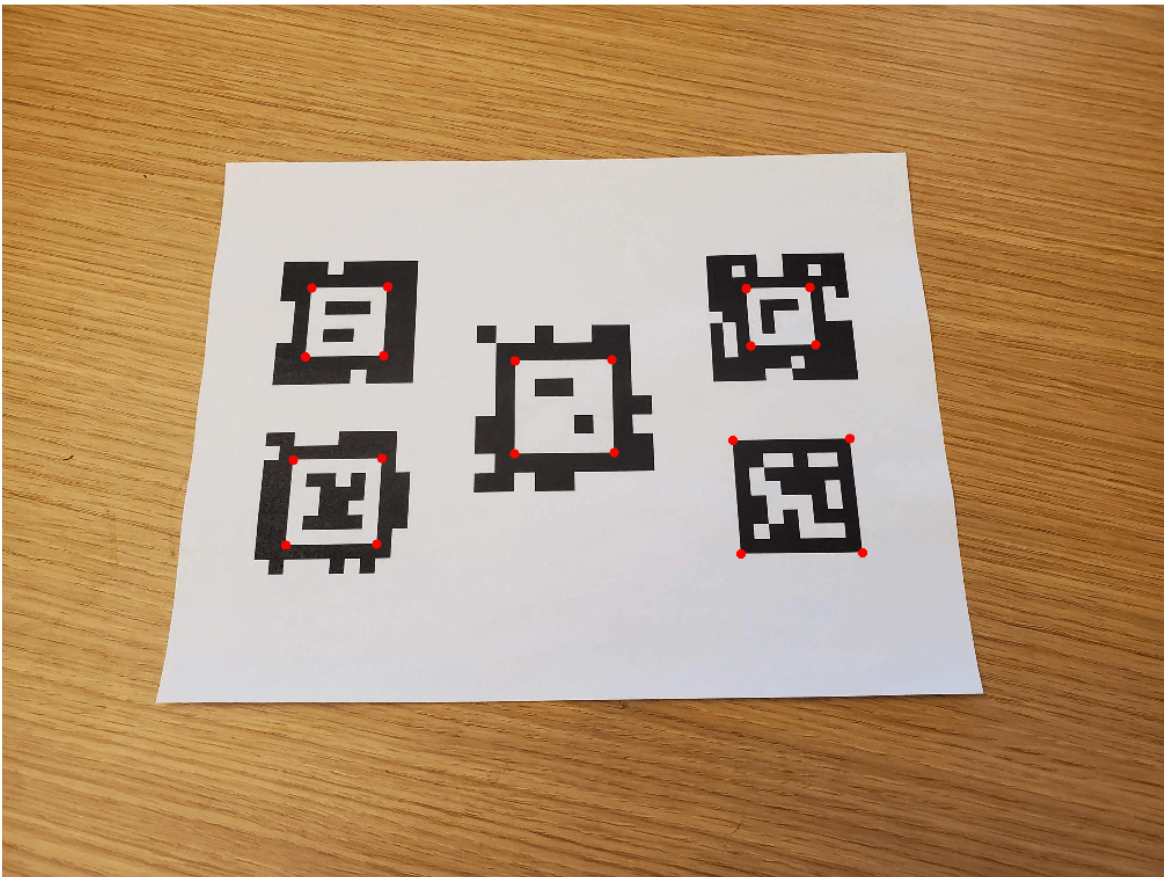

Estimate AprilTag Poses in Image

Read an image that contains AprilTags into the workspace. Display the image.

```
I = imread("aprilTag36h11.jpg");  
imshow(I)
```

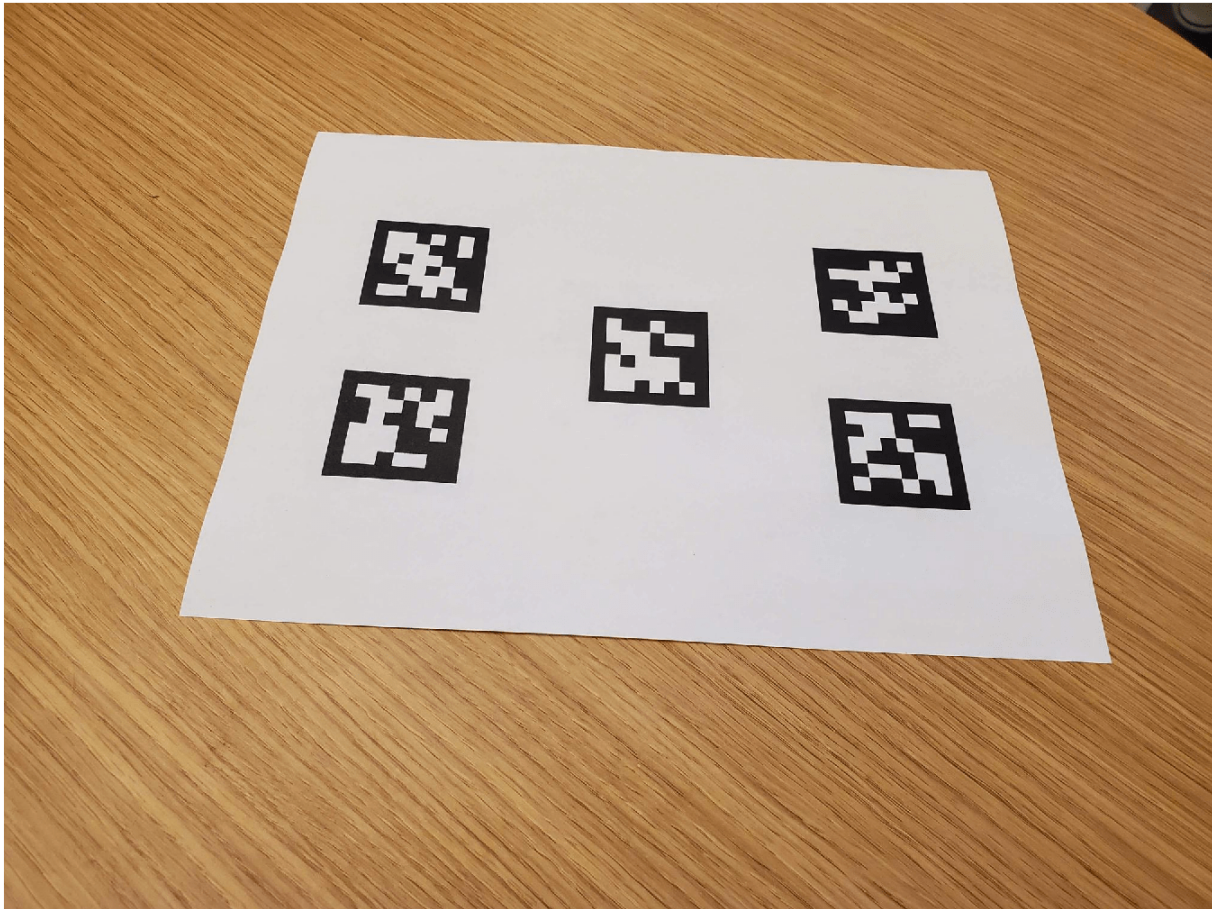
Load the camera intrinsic parameters.

```
data = load("camIntrinsicsAprilTag.mat");  
intrinsic = data.intrinsic;
```

Specify the tag size in meters.

```
tagSize = 0.04;
```

Undistort the input image using the camera intrinsic parameters.

```
I = undistortImage(I,intrinsic,"OutputView","same");
```

Detect a specific family of AprilTags and estimate the tag poses.

```
[id,loc,pose] = readAprilTag(I,"tag36h11",intrinsic,tagSize);
```

Set the origin for the axes vectors and for the tag frames.

```
worldPoints = [0 0 0; tagSize/2 0 0; 0 tagSize/2 0; 0 0 tagSize/2];
```

Add the tag frames and IDs to the image.

```
for i = 1:length(pose)
    % Get image coordinates for axes.
    imagePoints = worldToImage(intrinsics,pose(i).Rotation, ...
                               pose(i).Translation,worldPoints);

    % Draw colored axes.
    I = insertShape(I,"Line",[imagePoints(1,:) imagePoints(2,); ...
                              imagePoints(1,:) imagePoints(3,); imagePoints(1,:) imagePoints(4,)], ...
                   "Color",["red","green","blue"],"LineWidth",7);

    I = insertText(I,loc(1,:,i),id(i),"BoxOpacity",1,"FontSize",25);
end
```

Display the annotated image.

```
imshow(I)
```

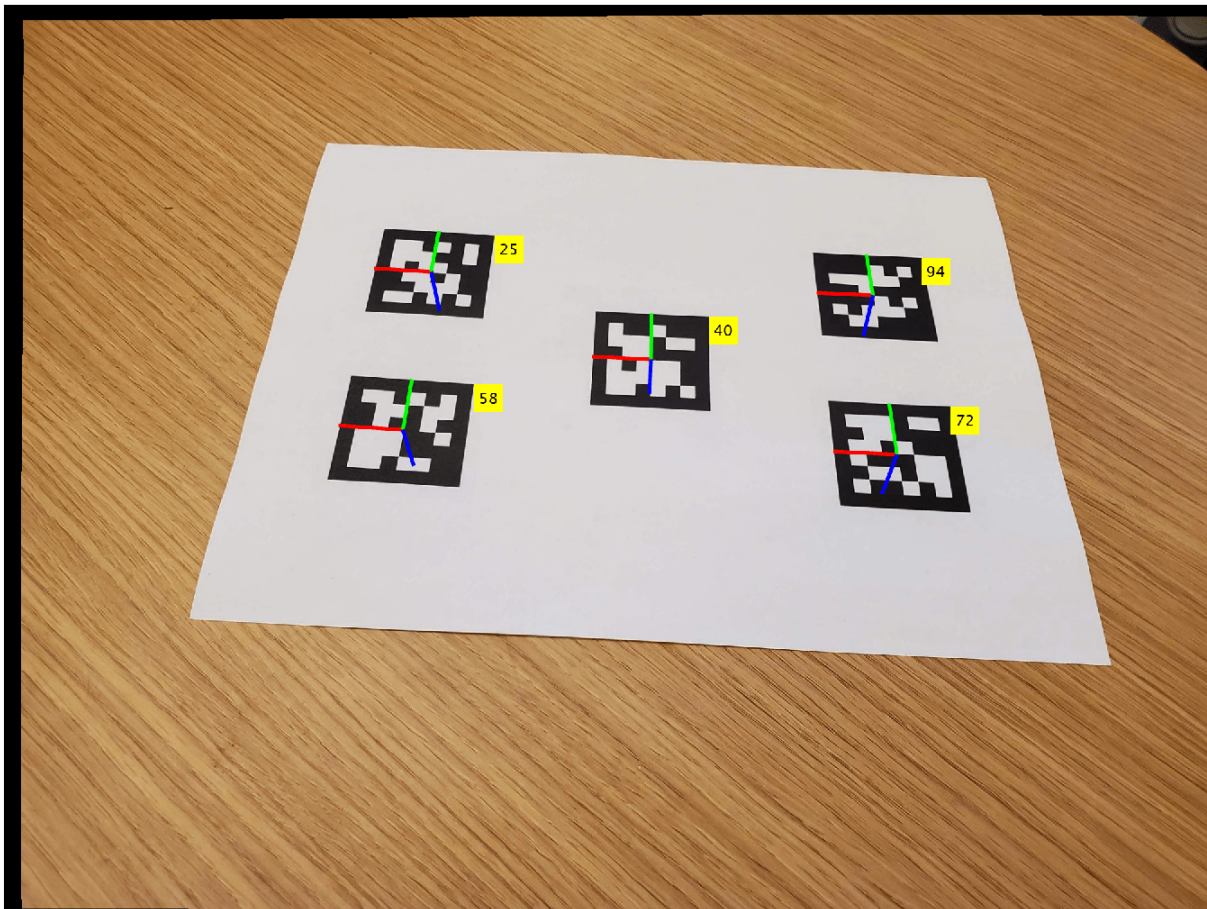

Input Arguments

I — Input image

M-by-*N*-by-3 truecolor image | *M*-by-*N* grayscale image

Input image, specified as an *M*-by-*N*-by-3 truecolor image or an *M*-by-*N* grayscale image.

tagFamily — AprilTag families

one or more valid AprilTag families

AprilTag families, specified as one or more of the valid AprilTag families listed in this table. Specifying a family can reduce the run time of the function by restricting the search.

AprilTag Family
"tag16h5"
"tag25h9"
"tag36h11"
"tagCircle21h7"
"tagCircle49h12"
"tagCustom48h12"
"tagStandard41h12"
"tagStandard52h13"

Data Types: char | string | cell

intrinsic — Camera intrinsic parameters

cameraIntrinsic object

Camera intrinsic parameters, specified as a cameraIntrinsic object.

tagSize — Size of tag

positive scalar

Size of the tags in world units (such as millimeters), specified as a positive scalar. The function defines the size of the tags as the length between two adjacent corner outer black edges.

Output Arguments

id — Tag IDs

vector of positive integers

Tag IDs, returned a vector of positive integers.

loc — Locations of tags in image

4-by-2-by-*N* array

Locations of tags in image, returned as a 4-by-2-by-*N* array. The array contains the (*x*,*y*) locations for each of the four corners for *N* tags.

pose — Poses of tags

array of rigid3d objects

Poses of tags with respect to the camera, returned as an array of `rigid3d` objects. Each object encapsulates the 3-D rigid transformation of a tag in the same world units as the `tagSize` input argument. The origin of each tag frame is located at the center of the corresponding tag.

detectedFamily – Detected tag families

vector of strings

Detected tag families, returned as a vector of strings.

Tips

- For applications that require real-time performance, while also minimizing false-positive detections, consider using the "tag36h11" family tag.
- For applications that require a faster detection time as opposed to the number of supported IDs, use the "tagStandard41h12" family tag.
- For pregenerated tags for all supported tag families, see Pregenerated AprilTag Images on GitHub.

Extended Capabilities

C/C++ Code Generation

Generate C and C++ code using MATLAB® Coder™.

- Generates code only on host platforms.
- You must specify the input argument `tagFamily` as a character vector or an array of character vectors. String inputs are not supported.

See Also

Functions

`readBarcode` | `rigid3d` | `cameraIntrinsics` | `worldToImage` | `insertText` | `insertShape` | `insertMarker`

Topics

"Camera Calibration Using AprilTag Markers"

"Landmark SLAM Using AprilTag Markers" (Navigation Toolbox)

Introduced in R2020b

evaluateDetectionAOS

Evaluate average orientation similarity metric for object detection

Syntax

```
metrics = evaluateDetectionAOS(detectionResults,groundTruthData)
metrics = evaluateDetectionAOS(detectionResults,groundTruthData,threshold)
```

Description

`metrics = evaluateDetectionAOS(detectionResults,groundTruthData)` computes the average orientation similarity (AOS) metric. The metric can be used to measure the detection results `detectionResults` against ground truth data `groundTruthData`. The AOS is a metric for measuring detector performance on rotated rectangle detections.

`metrics = evaluateDetectionAOS(detectionResults,groundTruthData,threshold)` additionally specifies the overlap threshold for assigning a detection to a ground truth bounding box.

Examples

Evaluate Rotated Rectangle Detections

Define ground truth bounding boxes for a vehicle class. Each row defines a rotated bounding box of the form `[xcenter, ycenter, width, height, yaw]`.

```
gtbbox = [
    2 2 10 20 45
    80 80 30 40 15
];
```

```
gtlabel = "vehicle";
```

Create a table to hold the ground truth data.

```
groundTruthData = table({gtbbox},'VariableNames',gtlabel)
```

```
groundTruthData=table
    vehicle
    _____
    {2x5 double}
```

Define detection results for rotated bounding boxes, scores, and labels.

```
bbox = [
    4 4 10 20 20
    50 50 30 10 30
    90 90 40 50 10 ];
```

```
scores = [0.9 0.7 0.8]';
```



```
labels = [
    "vehicle"
    "vehicle"
    "vehicle"
];
labels = categorical(labels,"vehicle");
```

Create a table to hold the detection results.

```
detectionResults = table({bbox},{scores},{labels}, 'VariableNames',{'Boxes','Scores','Labels'})
```

```
detectionResults=1x3 table
      Boxes      Scores      Labels
      -----      -----      -----
      {3x5 double}  {3x1 double}  {3x1 categorical}
```

Evaluate the detection results against ground truth by calculating the AOS metric.

```
metrics = evaluateDetectionAOS(detectionResults,groundTruthData)
```

```
metrics=1x5 table
      AOS      AP      OrientationSimilarity      Precision      Recall
      -----      -----      -----      -----      -----
      vehicle  0.5199  0.54545      {4x1 double}      {4x1 double}      {4x1 double}
```

Input Arguments

detectionResults — Detection results

three-column table

Detection results, specified as a three-column table. The columns contain bounding boxes, scores, and labels. The bounding boxes can be axis-aligned rectangles or rotated rectangles.

Bounding Box	Format	Description
Axis-aligned rectangle	$[x_{\min}, y_{\min}, width, height]$	This type of bounding box is defined in pixel coordinates as an M -by-4 matrix representing M bounding boxes

Bounding Box	Format	Description
Rotated rectangle	$[x_{\text{center}}, y_{\text{center}}, \text{width}, \text{height}, \text{yaw}]$	This type of bounding box is defined in spatial coordinates as an M -by-5 matrix representing M bounding boxes. The x_{center} and y_{center} coordinates represent the center of the bounding box. The <i>width</i> and <i>height</i> elements represent the length of the box along the x and y axes, respectively. The <i>yaw</i> represents the rotation angle in degrees. The amount of rotation about the center of the bounding box is measured in the clockwise direction.

groundTruthData — Labeled ground truth images

datastore | table

Labeled ground truth images, specified as a datastore or a table.

- If you use a datastore, your data must be set up so that calling the datastore with the `read` and `readall` functions returns a cell array or table with two or three columns. When the output contains two columns, the first column must contain bounding boxes, and the second column must contain labels, $\{\text{boxes}, \text{labels}\}$. When the output contains three columns, the second column must contain the bounding boxes, and the third column must contain the labels. In this case, the first column can contain any type of data. For example, the first column can contain images or point cloud data.

data	boxes	labels
The first column can contain data, such as point cloud data or images.	The second column must be a cell array that contains M -by-5 matrices of bounding boxes of the form $[x_{\text{center}}, y_{\text{center}}, \text{width}, \text{height}, \text{yaw}]$. The vectors represent the location and size of bounding boxes for the objects in each image. If the bounding box is axis-aligned, then you do not need to specify the yaw. Therefore, the bounding box would be described as an M -by-4 matrices of bounding boxes of the form $[x_{\text{center}}, y_{\text{center}}, \text{width}, \text{height}]$.	The third column must be a cell array that contains M -by-1 categorical vectors containing object class names. All categorical data returned by the datastore must contain the same categories.

For more information, see “Datastores for Deep Learning” (Deep Learning Toolbox).

- If you use a table, the table must have two or more columns.

data	boxes	...
The first column can contain data, such as point cloud data or images.	Each of the remaining columns must be a cell vector that contains M -by-5 matrices representing rotated rectangle bounding boxes. Each rotated rectangle must be of the form $[x_{center}, y_{center}, width, height, yaw]$. The vectors represent the location and size of bounding boxes for the objects in each image.	

threshold – Overlap threshold

nonnegative scalar

Overlap threshold, specified as a nonnegative scalar. The overlap ratio is defined as the intersection over union.

Output Arguments

metrics – AOS metrics

five-column table

AOS metrics, returned as a five-column table. Each row in the table contains the evaluation metrics for a class which is defined in the ground truth data contained in the `groundTruthData` input. To get the object class names:

`metrics.Properties.RowNames`

This table describes the five columns in the `metrics` table.

Column	Description
AOS	Average orientation similarity value
AP	Average precision over all the detection results, returned as a numeric scalar. Precision is a ratio of true positive instances to all positive instances of objects in the detector, based on the ground truth.
OrientationSimilarity	Orientation similarity values for each detection, returned as an M -element numeric column. M is one more than the number of detections assigned to a class. The first value of <code>OrientationSimilarity</code> is 1. Orientation similarity is a normalized variant of the cosine similarity that measures the similarity between the predicted rotation angle and the ground truth rotation angle.

Column	Description
Precision	<p>Precision values from each detection, returned as an M-element numeric column vector. M is one more than the number of detections assigned to a class. For example, if your detection results contain 4 detections with class label 'car', then Precision contains 5 elements. The first value of Precision is 1.</p> <p>Precision is a ratio of true positive instances to all positive instances of objects in the detector, based on the ground truth.</p>
Recall	<p>Recall values from each detection, returned as an M-element numeric column vector. M is one more than the number of detections assigned to a class. For example, if your detection results contain 4 detections with class label 'car', then Recall contains 5 elements. The first value of Recall is 0.</p> <p>Recall is a ratio of true positive instances to the sum of true positives and false negatives in the detector, based on the ground truth.</p>

References

- [1] Geiger, A., P. Lenz., and R. Urtasun. "Are we ready for autonomous driving? The KITTI vision benchmark suite." *IEEE Conference on Computer Vision and Pattern Recognition*. IEEE, 2012.

See Also

Functions

evaluateDetectionPrecision | evaluateDetectionMissRate | bboxOverlapRatio

Objects

boxLabelDatastore

Introduced in R2020a

ssdLayers

SSD multibox object detection network

Syntax

```
lgraph = ssdLayers(imageSize,numClasses,baseNetwork)
lgraph = ssdLayers( ____,anchorBoxes,predictorLayerNames)
```

Description

`lgraph = ssdLayers(imageSize,numClasses,baseNetwork)` creates a single shot detector (SSD) multibox object detection network based on the `baseNetwork`, input image size, and the number of classes the network should be configured to classify. The network is returned as an `LayerGraph` object.

The SSD is a convolutional neural network-based object detector that predicts bounding box coordinates, classification scores, and corresponding class labels.

`lgraph = ssdLayers(____,anchorBoxes,predictorLayerNames)` returns an SSD that contains custom anchor boxes specified by `anchorBoxes` that are connected to the network layers at locations specified by `predictorLayerNames`. Specify these arguments in addition to the input argument from the previous syntax.

Examples

Create SSD Network Using VGG-16 Network

Specify the base network.

```
baseNetwork = 'vgg16';
```

Specify the image size.

```
imageSize = [300 300 3];
```

Specify the classes to detect.

```
numClasses = 2;
```

Create the SSD object detection network.

```
lgraph = ssdLayers(imageSize,numClasses,baseNetwork);
```

Visualize the network using the network analyzer.

```
analyzeNetwork(lgraph)
```

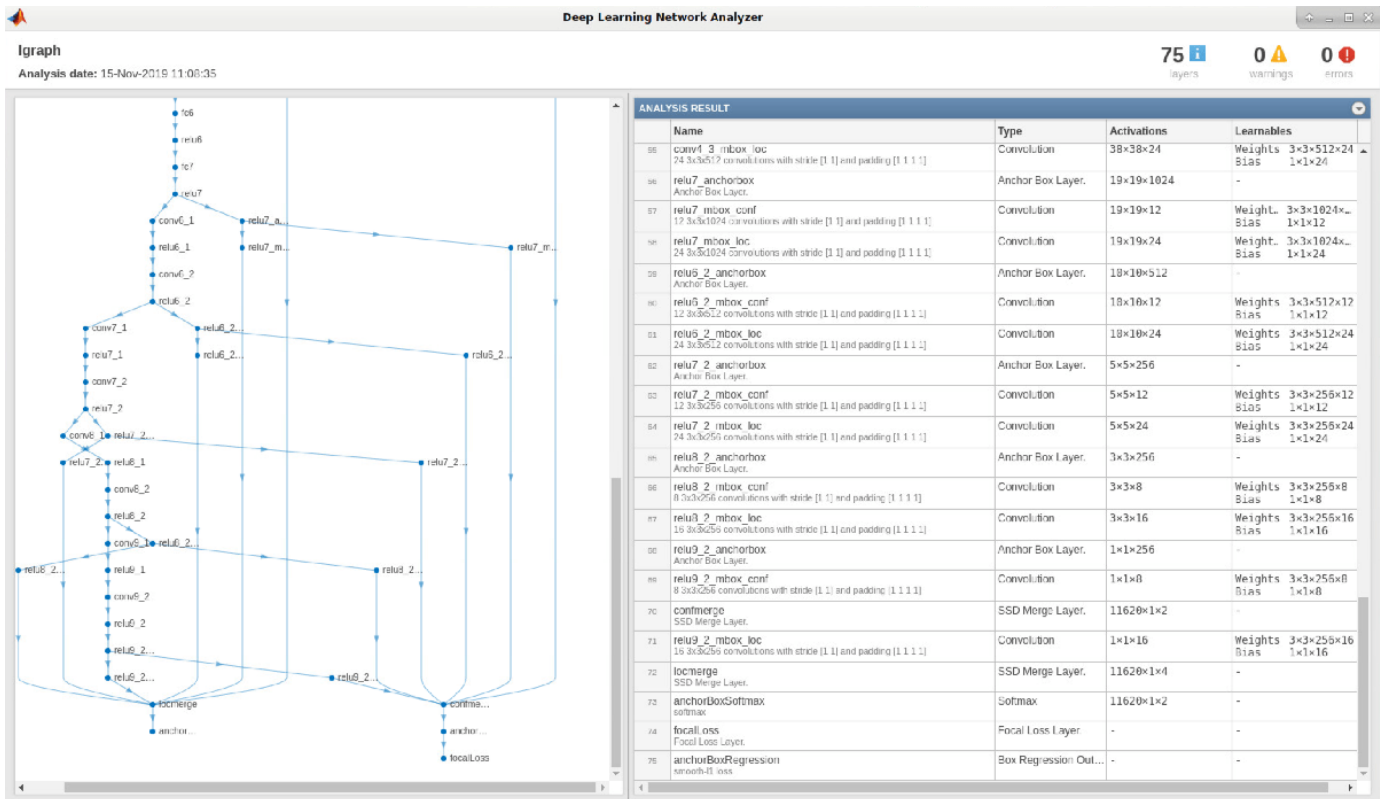

Input Arguments

imageSize — Size of input image
two-element vector | three-element vector

Size of input image, specified as one of these values.

- Two-element vector of the form $[H\ W]$ for a grayscale image of size H -by- W
- Three-element vector of the form $[H\ W\ 3]$ for an RGB color image of size H -by- W

When you set the baseNetwork input to 'vgg16', 'resnet50', or 'resnet101', the imageSize input must be of the form $[H\ W\ 3]$.

numClasses — Number of classes for network to classify
positive scalar

Number of classes for the network to classify, specified as a positive scalar.

baseNetwork — Pretrained convolutional neural network
LayerGraph object | DAGNetwork object | SeriesNetwork object | 'vgg16' | 'resnet50' | 'resnet101'

Pretrained convolutional neural network, specified as a LayerGraph, DAGNetwork, or SeriesNetwork object or as one of these network names. To specify one of these names, you must download and install the network support packages for the corresponding valid network names.

- vgg16
- resnet50
- resnet101

The pretrained convolutional neural network is used as the base for the SSD multibox object detection network. For details on pretrained networks in MATLAB, see “Pretrained Deep Neural Networks” (Deep Learning Toolbox).

anchorBoxes — Anchor boxes

1-by- M cell array

Anchor boxes, specified as a 1-by- M cell array for M number of predictor layers in the SSD network. Each predictor layer contains a K -by-2 matrix that defines K anchor boxes of the form [*height width*]. The number of anchor boxes in each element can vary.

The size of each anchor box is determined based on the scale and aspect ratio of different object classes present in input training data. The size of each anchor box must be smaller than or equal to the size of the input image. You can use the clustering approach for estimating anchor boxes from the training data. For more information, see “Estimate Anchor Boxes From Training Data”.

predictorLayerNames — Names of layers in input

M -element vector of strings | 1-by- M cell array of character vectors

Names of layers in input, specified as an M -element vector of strings or a 1-by- M cell array of character vectors. The SSD detection subnetworks are attached to the predictor layers specified by this input.

Output Arguments

lgraph — SSD multibox object detection network

LayerGraph object

SSD multibox object detection network, returned as a LayerGraph object.

Note The default value for the `Normalization` property of the image input layer in the returned `lgraph` object is set to the `Normalization` property of the base network specified in `baseNetwork`.

Algorithms

The `ssdLayers` function creates an SSD network and returns `lgraph`, an object that represents the network architecture for an SSD object detector.

The `trainSSDObjectDetector` function trains and returns an SSD object detector, `ssdObjectDetector`. Use the `detect` object function for the `ssdObjectDetector` object to detect objects using the detector trained with the SSD network architecture.

```
bbox = detect(detector,I)
```

The `ssdLayers` function uses a pretrained neural network as the base network, to which it adds a detection subnetwork required for creating an SSD object detection network. Given a base network, `ssdLayers` removes all the layers succeeding the feature layer in the base network and adds the

detection subnetwork. The detection subnetwork is comprised of groups of serially connected convolution, rectified linear unit (ReLU), and batch normalization layers. The SSD merge layer, a box regression layer, and a focal loss classification layer are added to the detection subnetwork.

References

- [1] Liu, Wei, Dragomir Anguelov, Dumitru Erhan, Christian Szegedy, Scott Reed, Cheng-Yang Fu, and Alexander C. Berg. "SSD: Single Shot MultiBox Detector." In *Computer Vision - ECCV 2016*, edited by Bastian Leibe, Jiri Matas, Nicu Sebe, and Max Welling, 9905:21-37. Cham: Springer International Publishing, 2016. https://doi.org/10.1007/978-3-319-46448-0_2.
- [2] Huang, Jonathan, Vivek Rathod, Chen Sun, Menglong Zhu, Anoop Korattikara, Alireza Fathi, Ian Fischer, et al. "Speed/Accuracy Trade-Offs for Modern Convolutional Object Detectors." In *2017 IEEE Conference on Computer Vision and Pattern Recognition (CVPR)*, 3296-97. Honolulu, HI:IEEE, 2017. <https://doi.org/10.1109/CVPR.2017.351>.

See Also

Objects

`ssdObjectDetector` | `anchorBoxLayer` | `focalLossLayer`

Functions

`trainSSDObjectDetector` | `analyzeNetwork` | `resnet50` | `vgg16` | `resnet101`

Topics

"Object Detection Using SSD Deep Learning"

"Create SSD Object Detection Network"

"Estimate Anchor Boxes From Training Data"

"Code Generation for Object Detection by Using Single Shot Multibox Detector"

"Getting Started with SSD Multibox Detection"

"Anchor Boxes for Object Detection"

"Datastores for Deep Learning" (Deep Learning Toolbox)

Introduced in R2020a

pcbin

Spatially bin point cloud points

Syntax

```
bins = pcbin(ptCloud,numBins)
bins = pcbin(ptCloud,numBins,spatialLimits)
[bins,binLocations] = pcbin(____)
[____] = pcbin(____,'BinOutput',true)
```

Description

`bins = pcbin(ptCloud,numBins)` spatially grids points in the point cloud, `ptCloud`. The output `bins` stores spatial bin locations, which are the indices for the points. The function finds the bin locations by sampling the point cloud in each dimension by the number of bins specified by `numBins`.

`bins = pcbin(ptCloud,numBins,spatialLimits)` specifies the spatial limits to use when the function places points into bins.

`[bins,binLocations] = pcbin(____)` also returns `binLocations`, the spatial bounds of each bin in `bins`. `binLocations` is the same size as `bins`.

`[____] = pcbin(____,'BinOutput',true)` also specifies the format of the `bins` and `binLocations` output.

When you set 'BinOutput' to true, `bins` and `binLocations` are returned as cell arrays of size `[numBinsX,numBinsY,numBinsZ]`.

When you set 'BinOutput' to false and `ptCloud` are unorganized point clouds, `bins` is returned as an M -by-1 numeric vector. `binLocations` is returned as an M -by-6 matrix.

When you set 'BinOutput' to false and `ptCloud` are organized point clouds, `bins` is returned an M -by- N matrix. `binLocations` is returned as an M -by- N -by-6 matrix.

Examples

Build Occupancy Grid from Point Cloud

Read point cloud data into the workspace.

```
ptCloud = pcread('teapot.ply');
```

Spatially bin the point cloud into a 32-by-32-by-32 grid.

```
indices = pcbin(ptCloud,[32 32 32]);
```

Build an occupancy grid.

```
occupancyGrid = cellfun(@(c) ~isempty(c), indices);
```

Display the occupancy grid.

```
ViewPnl = uipanel(figure);  
volshow(occupancyGrid, 'Parent', ViewPnl);
```

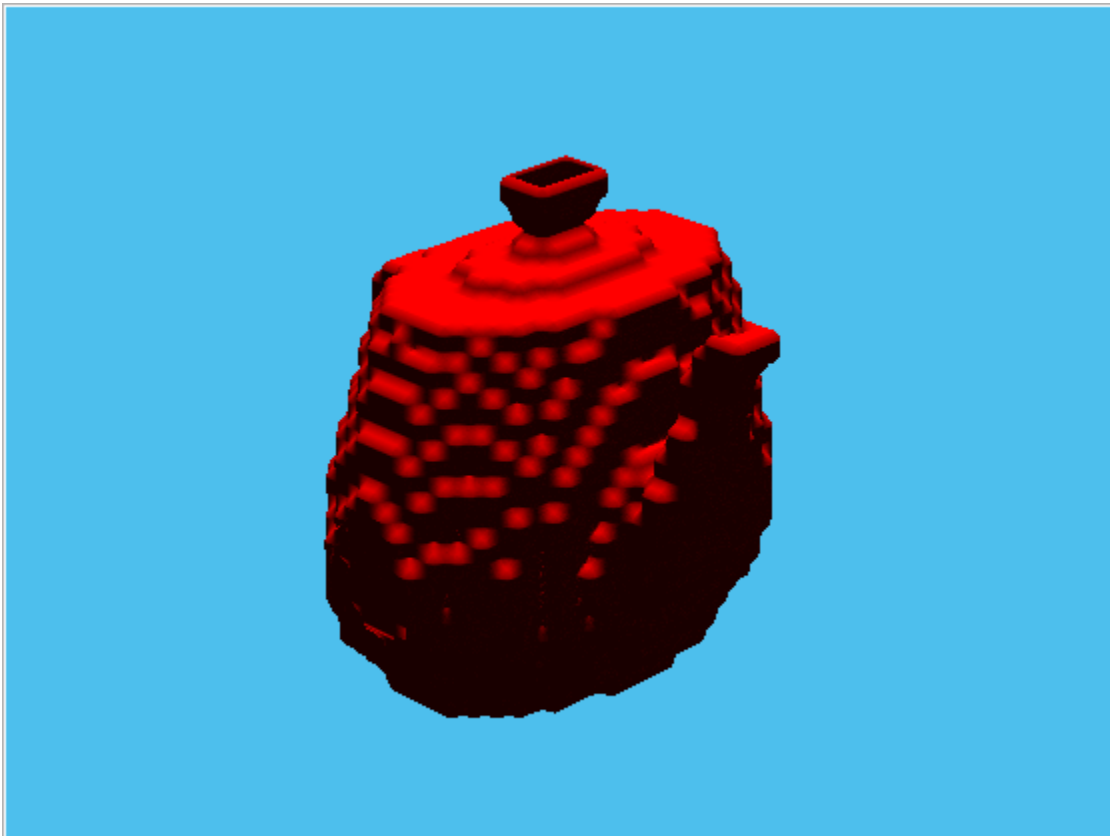

Build Bird's Eye View Density Grid from Point Cloud

Read point cloud data into the workspace.

```
ptCloud = pcread('teapot.ply');
```

Spatially bin the point cloud into a 32-by-32-by-1 grid.

```
indices = pccbin(ptCloud, [32 32 1]);
```

Build a density grid.

```
densityGrid = cellfun(@(c) ~isempty(c), indices);
```

Display the density grid.

```
figure;  
imagesc(densityGrid);
```

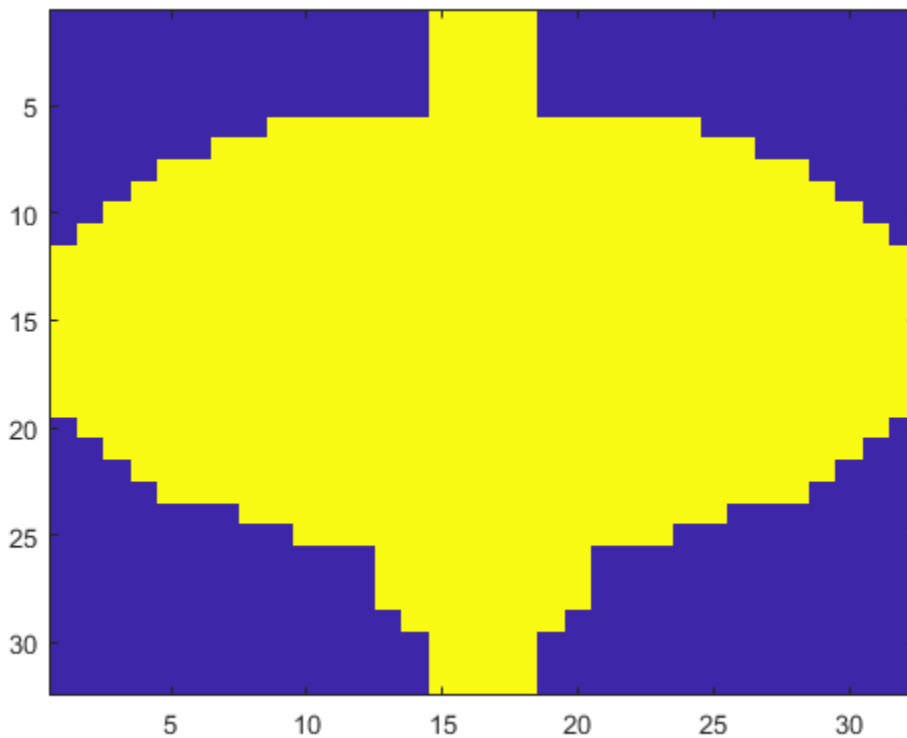

Input Arguments

ptCloud — Point cloud

`pointCloud` object

Point cloud, specified as a `pointCloud` object.

numBins — Number of bins

three-element numeric vector

Number of bins, specified as a three-element vector of the form $[numBinsX, numBinsY, numBinsZ]$. The vector elements indicate the number of bins to use in each dimension, respectively.

spatialLimits — Spatial limits

3-by-2 numeric matrix

Spatial limits, specified as a 3-by-2 numeric matrix of the form $[Xmin, Xmax; Ymin, Ymax; Zmin, Zmax]$. The spatial limits define the bounds used when the function bins points. Points that are outside of the specified limits are not included in the output.

Output Arguments

bins — Spatial bin locations

cell array | cell arrays of size $[numBinsX, numBinsY, numBinsZ]$ | M -by-1 numeric vector | M -by- N matrix

Spatial bin locations, returned as a cell array of the same size as input `numBins`, an M -by-1 numeric vector, or an M -by- N matrix. The function returns a cell array when you do not use the 'BinOutput' argument. Each cell in the array contains indices to locations of points in the input point cloud that define the bins. Each bin includes the left bin edge, except for the last bin which includes both bin edges.

The table describes the size of `bins` based how you specify the 'BinOutput' argument, and whether `ptCloud` is unorganized or organized.

'BinOutput'	bins
true	cell arrays of size $[numBinsX, numBinsY, numBinsZ]$
false	Unorganized point clouds M -by-1 numeric vector , where M represents the number of points.
	Organized point clouds M -by- N matrix, where M and N represents the total number of points set up as an organized point cloud.

The function processes invalid points differently, depending on how you specify the 'BinOutput' argument. Invalid points are points with coordinates that contain `Inf` or `NaN`. When you set 'BinOutput' to `true`, the function ignores invalid points and does not include them in the output. When you set 'BinOutput' to `false`, the function returns `NaN` values for invalid points.

binLocations — Bin spatial bounds

cell array | cell arrays of size $[numBinsX, numBinsY, numBinsZ]$ | M -by-6 matrix | M -by- N -by-6 matrix

Bin spatial bounds, returned as a cell array the same size as the output `bins`, cell arrays of size $[numBinsX, numBinsY, numBinsZ]$, an M -by-6 matrix, or an M -by- N -by-6 matrix. The function returns a cell array when you do not use the 'BinOutput' argument. Each cell in the array contains the spatial bounds of the bins in `bins`. The bounds for a bin are of the form $[Xmin, Xmax; Ymin, Ymax; Zmin, Zmax]$.

The table describes the size of `binLocations` based how you specify the 'BinOutput' argument, and whether `ptCloud` is unorganized or organized.

'BinOutput'	binLocations
true	cell arrays of size $[numBinsX, numBinsY, numBinsZ]$

'BinOutput'	binLocations
false	<p>Unorganized point clouds:</p> <p><i>M</i>-by-6 matrix, where <i>M</i> represents the number of points located in the bin specified by the [<i>Xmin</i>, <i>Xmax</i>; <i>Ymin</i>, <i>Ymax</i>; <i>Zmin</i>, <i>Zmax</i>] spatial bound.</p> <hr/> <p>Organized point clouds:</p> <p><i>M</i>-by-<i>N</i>-by-6 matrix, where <i>M</i> and <i>N</i> represents the number of points in an organized point cloud, with each point located in the bin specified by the [<i>Xmin</i>, <i>Xmax</i>; <i>Ymin</i>, <i>Ymax</i>; <i>Zmin</i>, <i>Zmax</i>] spatial bound.</p>

Extended Capabilities

C/C++ Code Generation

Generate C and C++ code using MATLAB® Coder™.

GPU Code Generation

Generate CUDA® code for NVIDIA® GPUs using GPU Coder™.

See Also

Functions

pctransform

Objects

pointCloud

Introduced in R2020a

readBarcode

Detect and decode 1-D or 2-D barcode in image

Syntax

```
msg = readBarcode(I)
msg = readBarcode(I,roi)
msg = readBarcode( ____,format)
[msg,detectedFormat,loc] = readBarcode( ____ )
```

Description

`msg = readBarcode(I)` detects and decodes a 1-D or 2-D barcode in the input image and returns the message associated with that barcode.

If the input image contains multiple barcodes, the `readBarcode` function decodes only the first barcode detected.

`msg = readBarcode(I,roi)` specifies a rectangular region of interest (ROI) to reduce the area in which the function searches for a barcode. The ROI must be fully contained in the input image.

`msg = readBarcode(____,format)` specifies barcode formats to reduce the types of barcodes for which the function searches. Specify this argument in addition to any of the input argument combinations in previous syntaxes.

`[msg,detectedFormat,loc] = readBarcode(____)` additionally returns the format, `detectedFormat`, and location, `loc`, of the detected barcode.

Examples

Detect and decode 1-D Barcode

Read an image containing a barcode into the workspace.

```
I = imread("barcode1D.jpg");
```

Detect the barcode and decode its message.

```
msg = readBarcode(I);
```

Display the decoded barcode message.

```
disp("Decoded barcode message: " + msg)
```

```
Decoded barcode message: 1234567890128
```

Search Image for 1-D Barcode

Read an image containing a barcode into the workspace.

```
I = imread("barcode1D.jpg");
```

Search the image for a 1-D barcode, returning its message, format, and location.

```
[msg,detectedFormat,loc] = readBarcode(I,'1D');
```

Display the detected barcode format.

```
disp("Barcode format: " + detectedFormat)
```

```
Barcode format: EAN-13
```

Annotate the image with the decoded barcode message.

```
xyBegin = loc(1,:);
```

```
Imsg = insertText(I,xyBegin,msg,'BoxOpacity',1,'FontSize',30);
```

Insert a line to show the scan row.

```
imSize = size(Imsg);
```

```
Imsg = insertShape(Imsg,'Line',[1 xyBegin(2) imSize(2) xyBegin(2)],'LineWidth',5);
```

Display the image.

```
imshow(Imsg)
```



Read a QR Barcode

Read an image containing a barcode.

```
I = imread("barcodeQR.jpg");
```

Define the ROI in the image that contains the barcode.

```
roi = [470, 300, 720, 620];
```

Search for a QR barcode within the ROI.

```
[msg,~,loc] = readBarcode(I,roi,"QR-CODE");
```

Annotate the image with the decoded message from the detected barcode.

```
xyText = loc(2,:);
Imsg = insertText(I,xyText,msg,"BoxOpacity",1,"FontSize",25);
```

Insert red circles onto the image to indicate the finder pattern locations.

```
Imsg = insertShape(Imsg, "FilledCircle", [loc, ...
    repmat(10, length(loc), 1)],"Color","red","Opacity",1);
```

Display the image.

```
imshow(Imsg)
```



Input Arguments

I – Input image

truecolor image | grayscale image

Input image, specified as a truecolor or grayscale image.

roi – Region of interest

four-element vector

Region of interest, specified as a four-element row vector of the form $[x, y, width, height]$. The rectangular ROI must be fully contained in the input image. $[x,y]$ specifies the starting point for the ROI relative to the upper-left corner of the image.

If an image contains multiple barcodes, specifying an ROI can help the function detect a particular barcode. For more information, see “Localize and Read Multiple Barcodes in Image”.

format — Barcode format

'1D' | '2D' | one or more valid barcode formats

Barcode format, specified as one of these options. The table lists valid barcode formats.

- 'all' — Use this option to specify all valid barcode formats. If you do not specify a format, the function uses this option.
- '1D' — Use this option to specify all valid 1-D barcode formats.
- '2D' — Use this option to specify all valid 2-D barcode formats.
- A character vector or string scalar of a valid format — Use this option to specify one barcode format.
- A cell array of character vectors or vector of strings of valid formats — Use this option to specify multiple barcode formats. The function prioritizes its search for specific barcode formats based on the order of the elements in this array.

Specifying a format can reduce the run time of the function by restricting the barcode search.

1-D Formats	2-D Formats
UPC-A	QR-CODE
UPC-E	DATA-MATRIX
EAN-8	AZTEC
EAN-13	PDF-417
CODE-39	
CODE-93	
CODE-128	
CODABAR	
ITF	
RSS-14	
RSS-EXPANDED	

Output Arguments**msg — Barcode message**

string scalar

Barcode message, returned as a string scalar.

detectedFormat — Detected barcode format

string scalar

Detected barcode format, returned as a string scalar of one of the formats in this table.



1-D Formats	2-D Formats
UPC-A	QR-CODE
UPC-E	DATA-MATRIX
EAN-8	AZTEC

1-D Formats	2-D Formats
EAN - 13	PDF - 417
CODE - 39	
CODE - 93	
CODE - 128	
CODABAR	
ITF	
RSS - 14	
RSS - EXPANDED	

Loc — Location of barcode

M-by-2 matrix | 2-by-2 matrix

Location of barcode, returned as an *M*-by-2 matrix for 2-D barcodes or a 2-by-2 matrix for 1-D barcodes. The matrix elements represent finder pattern locations.

Barcode	Loc Value	Finder Pattern Locations
2-D	<i>M</i> -by-2 matrix. <i>M</i> represents the number of [x, y] locations of finder patterns.	 
1-D	2-by-2 matrix of the form [x1, y1;x2, y2], where each row represents the location of a finder pattern.	

Tips

- The function detects only clearly visible barcodes.
- Specifying a format can reduce the run time of the function by restricting the barcode search.
- For noisy images with unclear barcodes, use image preprocessing functions, such as `imsharpen`.
- The function detects only horizontally or vertically aligned barcodes. Use `imrotate` to correct poorly aligned barcodes.

Extended Capabilities

C/C++ Code Generation

Generate C and C++ code using MATLAB® Coder™.

- Generates code only on host platforms.
- Input argument `format` must be specified as a string scalar, character vector, or cell array of character vectors. String arrays are not supported.

See Also

Functions

[imrotate](#) | [imsharpen](#) | [ocr](#) | [insertText](#) | [insertShape](#) | [insertMarker](#) | [readAprilTag](#)

Topics

[“Localize and Read Multiple Barcodes in Image”](#)

Introduced in R2020a

balanceBoxLabels

Balance bounding box labels for object detection

Syntax

```
locationSet = balanceBoxLabels(boxLabels,blockedImages,blockSize,
numObservations)
locationSet = balanceBoxLabels(boxLabels,blockedImages,blockSize,
numObservations,Name,Value)
```

Description

`locationSet = balanceBoxLabels(boxLabels,blockedImages,blockSize,numObservations)` balances bounding box labels, `boxLabels`, by oversampling blocks of images containing less frequent classes, contained in the collection of blocked image objects `blockedImages`. `numObservations` is the required number of block locations, and `blockSize` specifies the block size.

`locationSet = balanceBoxLabels(boxLabels,blockedImages,blockSize,numObservations,Name,Value)` specifies additional aspects of the selected blocks using name-value arguments.

Examples

Sample Block Sets to Use in Blocked Image Object Detection

Load box labels data that contains boxes and labels for one image. The height and width of each box is [20,20].

```
d = load('balanceBoxLabelsData.mat');
boxLabels = d.BoxLabels;
```

Create a blocked image of size [500,500].

```
blockedImages = blockedImage(zeros([500,500]));
```

Choose the images size of each observation.

```
blockSize = [50,50];
```

Visualize using a histogram to identify any class imbalance in the box labels.

```
blds = boxLabelDatastore(boxLabels);
datasetCount = countEachLabel(blds);
figure;
h1 = histogram('Categories',datasetCount.Label,'BinCounts',datasetCount.Count)
```

```
h1 =
    Histogram with properties:
        Data: [0x0 categorical]
```

```

        Values: [1 1 1 1 1 1 1 1 1 1 1 1 11]
NumDisplayBins: 12
  Categories: {1x12 cell}
  DisplayOrder: 'manual'
  Normalization: 'count'
  DisplayStyle: 'bar'
    FaceColor: 'auto'
    EdgeColor: [0 0 0]

```

Show all properties

Measure the distribution of box labels. If the coefficient of variation is more than 1, then there is class imbalance.

```
cvBefore = std(datasetCount.Count)/mean(datasetCount.Count)
```

```
cvBefore = 1.5746
```

Choose a heuristic value for number of observations by finding the mean of the counts of each class, multiplied by the number of classes.

```
numClasses = height(datasetCount);
numObservations = mean(datasetCount.Count) * numClasses;
```

Control the amount a box can be cut using `OverlapThreshold`. Using a lower threshold value will cut objects more at the border of a block. Increase this value to reduce the amount an object can be clipped at the border, at the expense of a less balanced box labels.

```
ThresholdValue = 0.5;
```

Balance `boxLabels` using the `balanceBoxLabels` function.

```
locationSet = balanceBoxLabels(boxLabels,blockedImages,blockSize,...
    numObservations,'OverlapThreshold',ThresholdValue);
```

```
Balancing box labels for 1 images with [=====] 100%
[=====] 100%
Balancing box labels complete.
```

Count the labels that are contained within the image blocks.

```
bldsBalanced = boxLabelDatastore(boxLabels,locationSet);
balancedDatasetCount = countEachLabel(bldsBalanced);
```

Overlay another histogram against the original label count to see if the box labels are balanced. If the labels appear to be not balanced by looking at the histograms, increase the value for `numObservations`.

```
hold on;
balancedLabels = balancedDatasetCount.Label;
balancedCount = balancedDatasetCount.Count;
h2 = histogram('Categories',balancedLabels,'BinCounts',balancedCount);
title(h2.Parent,"Balanced class labels (OverlapThreshold: " + ThresholdValue + ")");
legend(h2.Parent,{'Before','After'});
```

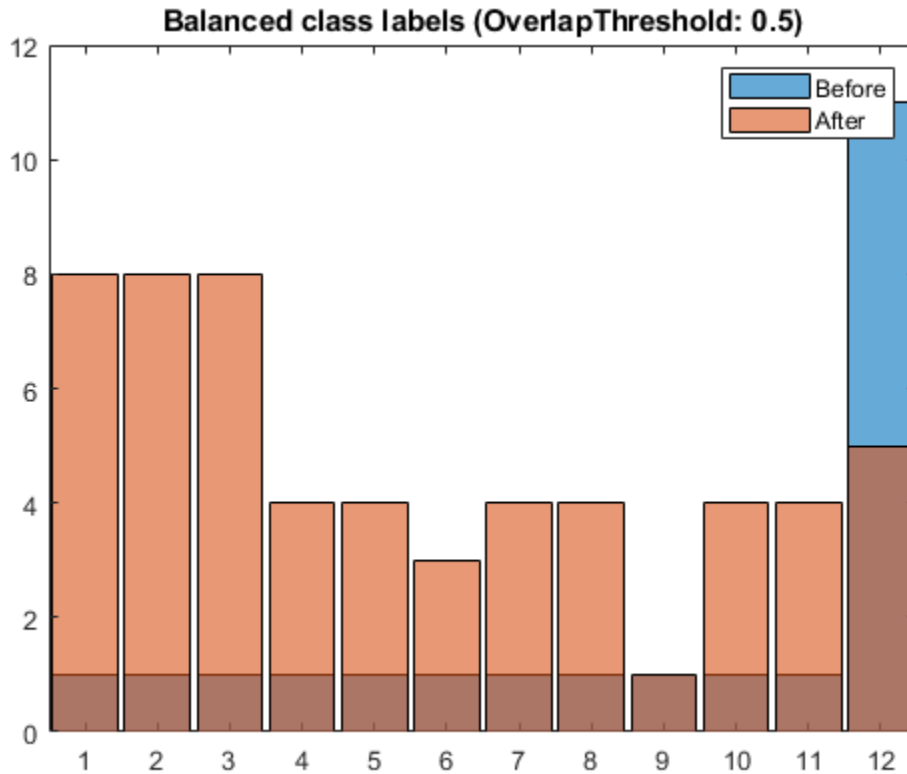

Measure the distribution of the new balanced box labels.

```
cvAfter = std(balancedCount)/mean(balancedCount)
```

```
cvAfter = 0.4588
```

Input Arguments

boxLabels — Labeled bounding box data

table with two columns

Labeled bounding box data, specified as a table with two columns.

- The first column contains bounding boxes and must be a cell vector. Each element in the cell vector contains M -by-4 matrices in the format $[x, y, width, height]$ for M boxes.
- The second column must be a cell vector that contains the label names corresponding to each bounding box. Each element in the cell vector must be an M -by-1 categorical or string vector.

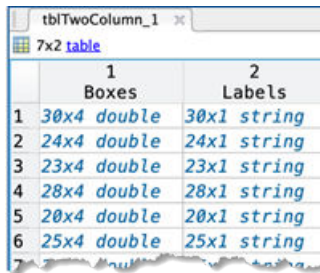

	1 Boxes	2 Labels
1	30x4 double	30x1 string
2	24x4 double	24x1 string
3	23x4 double	23x1 string
4	28x4 double	28x1 string
5	20x4 double	20x1 string
6	25x4 double	25x1 string
7		

To create a box label table from ground truth data,

- 1 Use the **Image Labeler** or **Video Labeler** app to label your ground truth. Export the labeled ground truth data to your workspace.
- 2 Create a bounding box label datastore using the `objectDetectorTrainingData` function.
- 3 You can obtain the `boxLabels` from the `LabelData` property of the box label datastore returned by `objectDetectorTrainingData`, (`blds.LabelData`).

blockedImages — Labeled blocked images

array of `blockedImage` objects

Labeled blocked images, specified as an array of `blockedImage` objects containing pixel label images.

blockSize — Block size

two-element row vector of positive integers

Block size of read data, specified as a two-element row vector of positive integers, `[numrows,numcols]`. The first element specifies the number of rows in the block. The second element specifies the number of columns.

numObservations — Number of block locations

positive integer

Number of block locations to return, specified as a positive integer.

Name-Value Pair Arguments

Specify optional comma-separated pairs of `Name,Value` arguments. `Name` is the argument name and `Value` is the corresponding value. `Name` must appear inside quotes. You can specify several name and value pair arguments in any order as `Name1,Value1,...,NameN,ValueN`.

Example: `'OverlapThreshold','1'`

Levels — Resolution level of each image

1 (default) | positive integer scalar | B -by-1 vector of positive integers

Resolution level of each image in the array of `blockedImage` objects, specified as a positive integer scalar or a B -by-1 vector of positive integers, where B is the length of the array of `blockedImage` objects.

OverlapThreshold — Overlap threshold

1 (default) | scalar in the range `[0,1]`

Overlap threshold, specified as a positive scalar in the range `[0,1]`. When the overlap between a bounding box and a cropping window is greater than the threshold, boxes in the `boxLabels` input

are clipped to the image block window border. When the overlap is less than the threshold, the boxes are discarded. When you lower the threshold, part of an object can get discarded. To reduce the amount an object can be clipped at the border, increase the threshold. Increasing the threshold can also cause less-balanced box labels.

The amount of overlap between the bounding box and a cropping window is defined as.

$$\text{area}(\text{bboxA} \cap \text{window}) / \text{area}(\text{bboxA})$$

Verbose — Display progress information

`true` or `1` (default) | `false` or `0`

Display progress information, specified as a numeric or logical `1` (`true`) or `0` (`false`). Set this property to `true` to display information.

Output Arguments

locationSet — Balanced box labels

`blockLocationSet` object

Balanced box labels, returned as a `blockLocationSet` object. The object contains `numObservations` number of locations of balanced blocks, each of size `blockSize`.

Algorithms

Balancing Box Labels

To balance box labels, the function over samples classes that are less represented in the blocked image or big image. The box labels are counted across the dataset and sorted based on each class count. Each image size is split into several quadrants, based on the `blockSize` input value. The algorithm randomly picks several blocks within each quadrant with less-represented classes. The blocks without any objects are discarded. The balancing stops once the specified number of blocks are selected.

Checking for Balance

You can check the success of balancing by comparing the histograms of label count before and after balancing. You can also check the coefficient of variation value. For best results, the value should be less than the original value. For more information, see the National Institute of Standards and Technology (NIST) website, see Coefficient of Variation for more information.

Compatibility Considerations

`bigLabeledImages` argument is not recommended

Not recommended starting in R2021a

The `bigLabeledImages` argument, which supports `bigimage` objects, is not recommended. Use the `blockedImages` argument instead, which supports `blockedImage` objects. The `blockedImage` object offers several advantages including extension to N-D processing, a simpler interface, and custom support for reading and writing nonstandard image formats.

Although there are no plans to remove the `bigLabeledImages` argument at this time, switch to the `blockedImages` argument to take advantage of the additional capabilities and flexibility.

To update your code, follow these steps:

- Replace `bigimage` object input with `blockedImage` object input for the second argument of this function.
- If you want to select blocks of any of the blocked images at a resolution level other than 1, then specify the 'Levels' name-value argument. You can omit this argument when you want to select blocks from all blocked images at resolution level 1.

The table gives an example of how to update your code.

Discouraged Usage	Recommended Replacement
<p>This example selects blocks at resolution level 1 from a <code>bigimage</code> object.</p> <pre>boxLabels = load('balanceBoxLabelsData.mat'); bim = bigimage(zeros([500,500])); blockSize = [50 50]; numObservations = 20; locationSet = balanceBoxLabels(boxLabels,bim, ... blockSize,numObservations);</pre>	<p>Here is equivalent code, replacing the input <code>bigimage</code> object with a <code>blockedImage</code> object.</p> <pre>boxLabels = load('balanceBoxLabelsData.mat'); bim = blockedImage(zeros([500,500])); blockSize = [50 50]; numObservations = 20; locationSet = balanceBoxLabels(boxLabels,bim, ... blockSize,numObservations);</pre>

See Also

Objects

`blockLocationSet` | `blockedImage` | `blockedImageDatastore` | `boxLabelDatastore`

Introduced in R2020a

balancePixelLabels

Balance pixel labels by oversampling block locations in large images

Syntax

```
blockLocations = balancePixelLabels(blockedImages, blockSize, numObservations)
blockLocations = balancePixelLabels(blockedImages, blockSize, numObservations,
Name, Value)
```

Description

`blockLocations = balancePixelLabels(blockedImages, blockSize, numObservations)` creates a list of block locations in the large labeled images, `blockedImages`, that result in a class balanced data set by oversampling image regions that contain less-common labels. `numObservations` is the required number of block locations, and `blockSize` specifies the block size.

A balanced dataset can produce better results when used for training workflows such as semantic segmentation in deep learning.

`blockLocations = balancePixelLabels(blockedImages, blockSize, numObservations, Name, Value)` specifies additional aspects of the selected blocks using name-value arguments.

Examples

Balance Pixel Labels in Unbalanced Dataset

Specify the location of a labeled image dataset.

```
dataDir = fullfile(toolboxdir('vision'), 'visiondata');
labelDir = fullfile(dataDir, 'buildingPixelLabels');
fileSet = matlab.io.datastore.FileSet(labelDir, "FileExtensions", {'.png'});
```

Create an array of labeled images from the dataset.

```
blockedImages = blockedImage(fileSet);
```

Set block size of the images. Assume finest resolution level.

```
blockSize = [20 15];
```

Create a `blockedImageDatastore` from the image array.

```
blabelds = blockedImageDatastore(blockedImages, 'BlockSize', blockSize);
```

Count pixel label occurrences of each class. The classes in the pixel label images are not balanced.

```
pixelLabelID = [1 2 3 4];
classNames = ["sky" "grass" "building" "sidewalk"];
labelCounts = countEachLabel(blabelds, ...
    'Classes', classNames, 'PixelLabelIDs', pixelLabelID);
```

Specify number of block locations to sample from the dataset.

```
numObservations = 2000;
```

Select block locations from the labeled images to achieve class.

```
locationSet = balancePixelLabels(blockedImages, blockSize, numObservations,...
    'Classes', classNames, 'PixelLabelIDs', pixelLabelID);
```

Create a `blockedImageDatastore` using the block locations after balancing.

```
lblabeldsBalanced = blockedImageDatastore(blockedImages, 'BlockLocationSet', locationSet);
```

Recalculate the pixel label occurrences for the balanced dataset.

```
labelCountsBalanced = countEachLabel(lblabeldsBalanced,...
    'Classes', classNames, 'PixelLabelIDs', pixelLabelID);
```

Compare the original unbalanced labels and labels after label balancing.

```
figure
h1 = histogram('Categories',labelCounts.Name,...
    'BinCounts',labelCounts.PixelCount)
```

```
h1 =
    Histogram with properties:
```

```
        Data: [0x0 categorical]
        Values: [314849 159787 1031235 25313]
    NumDisplayBins: 4
        Categories: {'sky' 'grass' 'building' 'sidewalk'}
        DisplayOrder: 'manual'
    Normalization: 'count'
        DisplayStyle: 'bar'
        FaceColor: 'auto'
        EdgeColor: [0 0 0]
```

```
Show all properties
```

```
title(h1.Parent,'Original dataset labels')
```

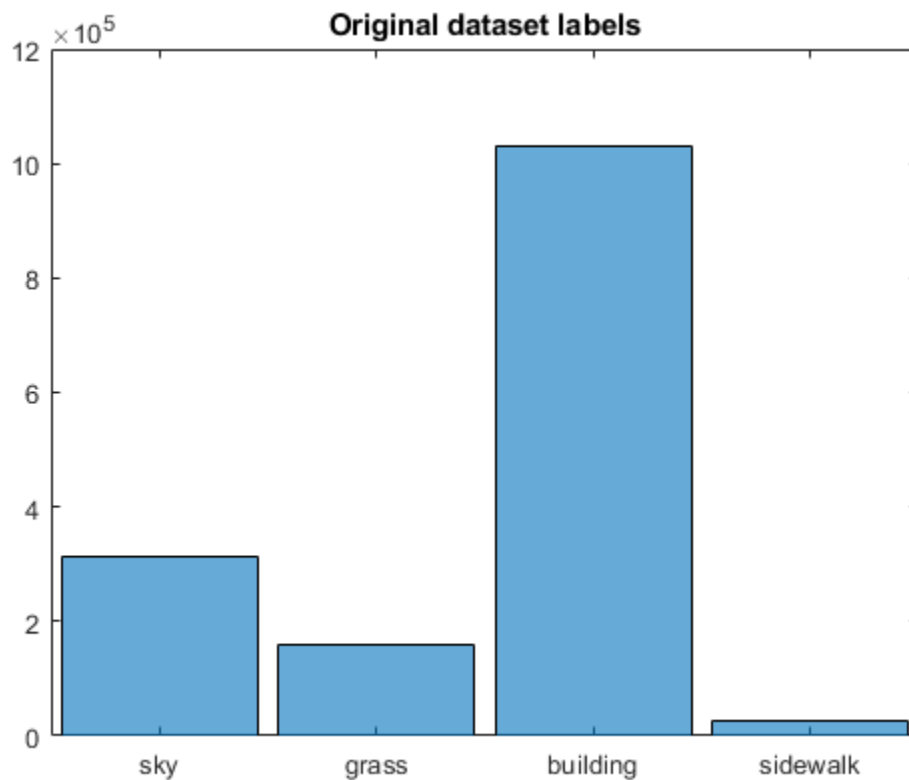

```
figure
h2 = histogram('Categories',labelCountsBalanced.Name,...
              'BinCounts',labelCountsBalanced.PixelCount)

h2 =
Histogram with properties:
    Data: [0x0 categorical]
    Values: [131906 241546 81006 143167]
    NumDisplayBins: 4
    Categories: {'sky' 'grass' 'building' 'sidewalk'}
    DisplayOrder: 'manual'
    Normalization: 'count'
    DisplayStyle: 'bar'
    FaceColor: 'auto'
    EdgeColor: [0 0 0]

Show all properties

title(h2.Parent,'Balanced dataset labels')
```

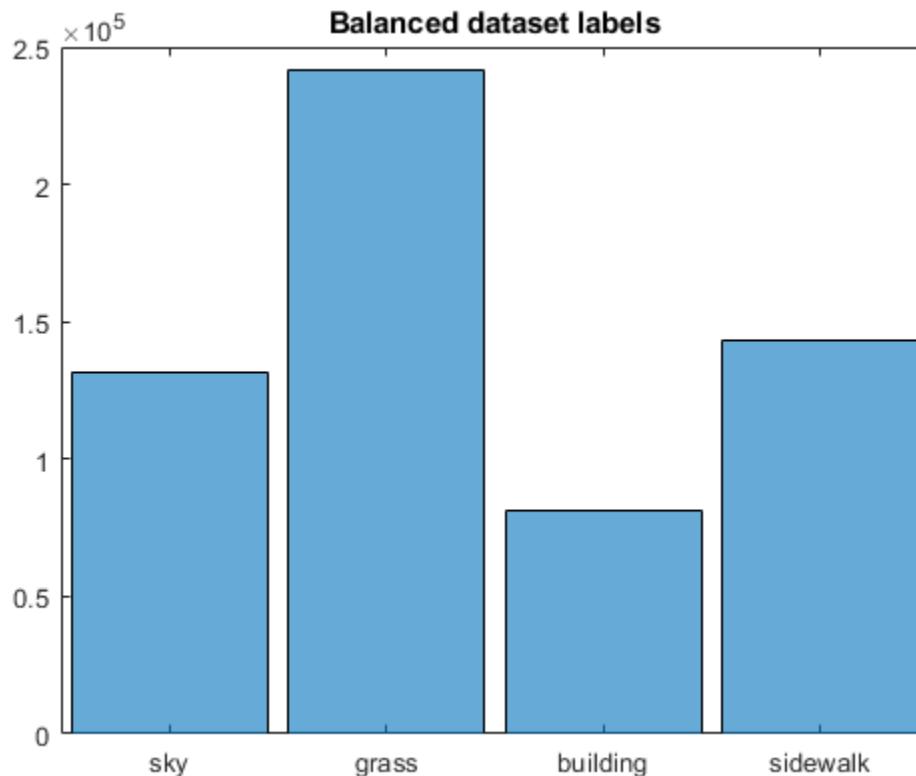

Input Arguments

blockedImages — Labeled blocked images

blockedImage object | vector of blockedImage objects

Labeled blocked images, specified as a blockedImage object or a vector of blockedImage objects containing pixel label images.

blockSize — Block size

two-element row vector of positive integers

Block size of read data, specified as a two-element row vector of positive integers, $[numrows, numcols]$. The first element specifies the number of rows in the block. The second element specifies the number of columns.

numObservations — Number of block locations

positive integer

Number of block locations to return, specified as a positive integer.

Name-Value Pair Arguments

Specify optional comma-separated pairs of Name, Value arguments. Name is the argument name and Value is the corresponding value. Name must appear inside quotes. You can specify several name and value pair arguments in any order as Name1, Value1, ..., NameN, ValueN.

Example: 'Classes', classNamees, 'PixelLabelIDs', pixelLabelID

Levels — Image resolution levels

1 (default) | numeric scalar | integer-valued vector

Image resolution levels, specified as a numeric scalar or an integer-valued vector of the same length as the vector of `blockedImages`. If you specify a scalar value, then all blocked images supply blocks at the specified resolution level.

Data Types: `single` | `double` | `int8` | `int16` | `int32` | `int64` | `uint8` | `uint16` | `uint32` | `uint64`

Classes — Set of class names

{ } (default) | `string` vector | cell array of char vectors

Set of class names, specified as a string vector or a cell array of character vectors.

You must specify this argument when `blockedImages` yields numeric data, such as when pixel label data is stored as an RGB image. Do not specify this argument when `blockedImages` yields categorical data.

Data Types: `char` | `string`

PixelLabelIDs — Numeric IDs that map labels to class names

[] (default) | numeric vector | M -by-3 numeric matrix

Numeric IDs that map labels to class names, specified as a vector of numeric IDs for each label or an M -by-3 matrix where M is the number of class names. The length of the vector must equal the number of class names. Each row is a three-element vector representing the RGB pixel value associated with each class name.

You must specify this argument when `blockedImages` yields numeric data, such as when pixel label data is stored as an RGB image. Do not specify this argument when `blockedImages` yields categorical data.

Data Types: `single` | `double` | `int8` | `int16` | `int32` | `int64` | `uint8` | `uint16` | `uint32` | `uint64`

UseParallel — Use new or existing pool

`false` or 0 (default) | `true` or 1

Use a new or existing parallel pool, specified as a numeric or logical 1 (`true`) or 0 (`false`). If no parallel pool is active, then a new pool is opened based on the default parallel settings. The `DataSource` property of all input `blockedImage` objects should be valid paths on each of the parallel workers.

This syntax requires the Parallel Computing Toolbox.

Data Types: `logical`

Output Arguments

blockLocations — Block locations

`blockLocationSet` object

Block locations, returned as a `blockLocationSet` object. The object contains `numObservations` number of locations of balanced blocks, each of size `blockSize`.

Algorithms

To balance pixel labels, the function oversamples the minority classes in the input images. The minority class is determined by calculating the overall pixel label counts for the complete dataset. The algorithm follows these steps.

- 1 The images in the input image array are divided into macro blocks, which is a multiple of the `blockSize` input value.
- 2 The function counts pixel labels for all classes in each macro block. Then, it selects the macro block with the greatest occurrences of minority classes using weighted random selection.
- 3 The algorithm uses a random block location within the selected macro block to perform oversampling. The origin of the block location must always be fully within the limits of the macro block.
- 4 The function updates the overall label counts based on the pixel label counts of the classes found for the selected macro block.
- 5 The function includes the new (oversampled) classes to compute new minority class.
- 6 This process repeats until the number of block locations processed equals the value specified by the `numObservations` input value.

Compatibility Considerations

bigLabeledImages argument is not recommended

Not recommended starting in R2021a

The `bigLabeledImages` argument, which supports `bigimage` objects, is not recommended. Use the `blockedImages` argument instead, which supports `blockedImage` objects. The `blockedImage` object offers several advantages including extension to N-D processing, a simpler interface, and custom support for reading and writing nonstandard image formats.

Although there are no plans to remove the `bigLabeledImages` argument at this time, switch to the `blockedImages` argument to take advantage of the additional capabilities and flexibility.

To update your code, follow these steps:

- Replace `bigimage` object input with `blockedImage` object input for the first argument of this function.
- If you want to select blocks of any of the blocked images at a resolution level other than 1, then specify the `'Levels'` name-value argument. You can omit this argument when you want to select blocks from all blocked images at resolution level 1.
- If the blocked images yield numeric data, such as representing pixel label data as an RGB image, then specify the `'Classes'` and `'PixelLabelsIDs'` name-value arguments.

The table gives an example of how to update your code.

Discouraged Usage	Recommended Replacement
<p>This example selects blocks at resolution level 1 from a labeled bigimage object.</p> <pre> pixelLabelIDs = [1 2 3 4]; classNames = ["sky" "grass" "building" "sidewalk"]; labelDir = fullfile(toolboxdir('vision'), 'visiondata', 'buildingPixelLabels'); filename = fullfile(labelDir, 'Label_1.png'); bim = bigimage(imread(filename), ... 'Classes', classNames, 'PixelLabelIDs', pixelLabelIDs); blockSize = [20 15]; numObservations = 2000; locationSet = balancePixelLabels(bim, 1, ... blockSize, numObservations); </pre>	<p>Here is equivalent code, replacing the input bigimage object with a blockedImage object.</p> <pre> pixelLabelIDs = [1 2 3 4]; classNames = ["sky" "grass" "building" "sidewalk"]; labelDir = fullfile(toolboxdir('vision'), 'visiondata', 'buildingPixelLabels'); filename = fullfile(labelDir, 'Label_1.png'); bim = blockedImage(filename); blockSize = [20 15]; numObservations = 2000; locationSet = balancePixelLabels(bim, ... blockSize, numObservations, ... 'Classes', classNames, 'PixelLabelIDs', pixelLabelIDs); </pre>

See Also

Objects

blockLocationSet | blockedImage | blockedImageDatastore | countEachLabel

Introduced in R2020a

showvipblockdatatypetable

Simulink Block Data Type Support Table

Syntax

```
showvipblockdatatypetable
```

Description

`showvipblockdatatypetable` returns a table that shows characteristics for the Simulink blocks in Computer Vision Toolbox. The table provides details regarding capabilities and limitations pertaining to code generation, variable-sizing, and supported data types for all Computer Vision Toolbox blocks. An "X" in a cell indicates a given block supports the capability indicated by the column heading. Numbered footnotes included in cells, "(#)", are described below the table.

Examples

Show Block Characteristics For Computer Vision Toolbox

You can use the `showvipblockdatatypetable` function to return a table of block characteristics for the Computer Vision Toolbox.

To return the table of block characteristics, at the MATLAB® command line type:

```
showvipblockdatatypetable
```

```
Loading Computer Vision Toolbox Library.
```

The table opens in a separate window.

Introduced in R2008b

read

Read data from a datastore

Syntax

```
C = read(ds)
[C,info] = read(ds)
```

Description

`C = read(ds)` returns data from a pixel label, pixel image label, or box label datastore. Subsequent calls to the `read` function continue reading from the endpoint of the previous call.

`[C,info] = read(ds)` also returns information about the extracted data in `info`, including metadata.

Input Arguments

ds — Input datastore

PixelLabelDatastore object | PixelImageLabelDatastore object | boxLabelDatastore object

Input datastore, specified as a PixelLabelDatastore, pixelLabelImageDatastore, or a boxLabelDatastore object.

Output Arguments

C — Output data

cell array of categorical matrices | *M*-by-2 cell array | table

Output data, returned as an *M*-by-2 cell array, cell array of categorical matrices, or a table.

Datastore	Output Description
PixelLabelDatastore	Table with MiniBatchSize number of rows. For the last batch of data in the datastore, numObservations must be divisible by MiniBatchSize or read returns a partial batch containing all the remaining observations in the datastore.
PixelLabelImageDatastore	

Datastore	Output Description
boxLabelDatastore	<p>N-by-2 or N-by-3 cell matrix. N must be less than or equal to <code>ReadSize(ds)</code>.</p> <p>The first column can contain data, such as point cloud data for point cloud detectors, or images for object detectors.</p> <p>The second column must be a cell vector that contains M-by-5 matrices of bounding boxes in the format <code>[xcenter,ycenter,width,height,yaw]</code>.</p> <p>The third column must be a cell vector that contains the label names corresponding to each bounding box. Label names are represented as an M-by-1 categorical vector.</p>

You can use the `combine` function to create a datastore to use for training.

- `imageDatastore` — Create a datastore containing images.
- `PixelLabelDatastore` — Create a datastore containing pixel data.
- `boxLabelDatastore` — Create a datastore containing bounding boxes and labels.
- `combine(imds,bls)` — Combine images, bounding boxes, and labels into one datastore.
- `combine(pxds,bls)` — Combine pixel data, bounding boxes, and labels into one datastore.

For more information, see “Datastores for Deep Learning” (Deep Learning Toolbox).

info — Information about read data

structure array

Information about read data, returned as a structure array. The structure array can contain the following fields.

Datastore	Field Name	Description
PixelLabelDatastore	Filename	Fully resolved path containing the path string, name of the file, and file extension. For <code>PixelLabelDatastore</code> objects whose <code>ReadSize</code> property is greater than 1, <code>Filename</code> is a cell array of file names corresponding to each image.
	FileSize	Total file size, in bytes. For MAT-files, <code>FileSize</code> is the total number of key-value pairs in the file. For <code>PixelLabelDatastore</code> objects whose <code>ReadSize</code> property is greater than 1, <code>FileSize</code> is a vector of file sizes corresponding to each image.

Datastore	Field Name	Description
PixelLabelImageDatastore	ImageFilename	Fully resolved path containing the path string, name of the image file, and file extension.
	PixelLabelFilename	Fully resolved path containing the path string, name of the pixel label file, and file extension.
boxLabelDatastore	CurrentIndex	Starting position of each read operation of the label data.
	ReadSize	ReadSize property of the datastore.

Tips

- `read(ds)` returns an error if there is no more data in the input datastore, `ds`. Use `hasdata(ds)` with `read(ds)` to avoid the error.

See Also

`datastore` | `pixelLabelDatastore` | `pixelLabelImageDatastore` | `read (Datastore)` | `readByIndex` | `readall` | `boxLabelDatastore`

Introduced in R2017b

shuffle

Return shuffled version of datastore

Syntax

```
shuffle(ds)
```

Description

`shuffle(ds)` returns a randomly shuffled version of the input datastore.

Examples

Create Randomly Shuffled Datastore

Set the location of the image and pixel label data.

```
dataDir = fullfile(toolboxdir('vision'), 'visiondata');  
pxDir = fullfile(dataDir, 'buildingPixelLabels');
```

Create a pixel label datastore.

```
classNames = ["sky" "grass" "building" "sidewalk"];  
pixelLabelID = [1 2 3 4];  
pxds = pixelLabelDatastore(pxDir, classNames, pixelLabelID);
```

Create a new randomly shuffled datastore.

```
shpxds = shuffle(pxds);
```

Input Arguments

ds — Datastore with labeled data

boxLabelDatastore object | pixelLabelDatastore | pixelLabelImageDatastore

Datastore with labeled data for training a semantic segmentation network or an object detection network, specified as a `boxLabelDatastore`, `pixelLabelDatastore`, or a `pixelLabelImageDatastore` object.

See Also

Functions

`objectDetectorTrainingData`

Objects

`datastore` | `boxLabelDatastore` | `pixelLabelDatastore`

Introduced in R2020a

preview

Read first row of data in datastore

Syntax

```
preview(ds)
```

Description

`preview(ds)` returns the first row of data in the input datastore.

Examples

Preview Data From Datastore

Load training data that contains bounding boxes with labels for a vehicles class.

```
data = load('vehicleTrainingData.mat');
trainingData = data.vehicleTrainingData;
```

Add the fullpath to the local vehicle data folder.

```
dataDir = fullfile(toolboxdir('vision'),'visiondata');
trainingData.imageFilename = fullfile(dataDir,trainingData.imageFilename);
blds = boxLabelDatastore(trainingData(:,2:end));
```

Preview the data from the box label datastore.

```
preview(blds)
```

```
ans=1x2 cell array
    {[126 78 20 16]}    {[vehicle]}
```

Input Arguments

ds — Datastore with labeled data

`boxLabelDatastore` object | `pixelLabelDatastore`

Datastore with labeled data for training a semantic segmentation network or an object detection network, specified as a `boxLabelDatastore` or a `pixelLabelDatastore` object.

See Also

Functions

`objectDetectorTrainingData`

Objects

`datastore` | `boxLabelDatastore` | `pixelLabelDatastore`

Introduced in R2020a

progress

Percentage of data read from a datastore

Syntax

```
progress(ds)
```

Description

`progress(ds)` returns a fraction between 0.0 and 1.0 to indicate the percentage of data read from the datastore.

Examples

Read Datastore and Check Progress

Load training data that contains bounding boxes with labels for vehicles.

```
data = load('vehicleTrainingData.mat');
trainingData = data.vehicleTrainingData;
```

Add fullpath to the local vehicle data folder.

```
dataDir = fullfile(toolboxdir('vision'), 'visiondata');
trainingData.imageFilename = fullfile(dataDir, ...
                                     trainingData.imageFilename);
blds = boxLabelDatastore(trainingData(:,2:end));
```

Read a couple of times, before looking at the progress.

```
read(blds);
read(blds);
```

See the progress made by the `boxLabelDatastore`.

```
preview(blds)
```

```
ans=1x2 cell array
    {[126 78 20 16]}    {[vehicle]}
```

Input Arguments

ds — Datastore with labeled data

`boxLabelDatastore` object

Datastore with labeled data for training a semantic segmentation network or an object detection network, specified as a `boxLabelDatastore` object.

See Also

Functions

objectDetectorTrainingData

Objects

datastore | boxLabelDatastore

Introduced in R2019b

estimateAnchorBoxes

Estimate anchor boxes for deep learning object detectors

Syntax

```
anchorBoxes = estimateAnchorBoxes(trainingData,numAnchors)
[anchorBoxes,meanIoU] = estimateAnchorBoxes(trainingData,numAnchors)
```

Description

`anchorBoxes = estimateAnchorBoxes(trainingData,numAnchors)` estimates the specified number of anchor boxes using the training data.

`[anchorBoxes,meanIoU] = estimateAnchorBoxes(trainingData,numAnchors)` additionally returns the mean intersection-over-union (IoU) value of the anchor boxes in each cluster.

Examples

Estimate Anchor Boxes for YOLO v2 Object Detection Network

This example shows how to estimate anchor boxes using a table containing the training data. The first column contains the training images and the remaining columns contain the labeled bounding boxes.

```
data = load('vehicleTrainingData.mat');
trainingData = data.vehicleTrainingData;
```

Create a `boxLabelDatastore` object using the labeled bounding boxes from the training data.

```
blds = boxLabelDatastore(trainingData(:,2:end));
```

Estimate the anchor boxes using the `boxLabelDatastore` object.

```
numAnchors = 5;
anchorBoxes = estimateAnchorBoxes(blds,numAnchors);
```

Specify the image size.

```
inputImageSize = [128,228,3];
```

Specify the number of classes to detect.

```
numClasses = 1;
```

Use a pretrained ResNet-50 network as a base network for the YOLO v2 network.

```
network = resnet50();
```

Specify the network layer to use for feature extraction. You can use the `analyzeNetwork` function to see all the layer names in a network.

```
featureLayer = 'activation_49_relu';
```

Create the YOLO v2 object detection network.

```
lgraph = yolov2Layers(inputImageSize,numClasses,anchorBoxes,network, featureLayer)

lgraph =
  LayerGraph with properties:

    Layers: [182x1 nnet.cnn.layer.Layer]
    Connections: [197x2 table]
    InputNames: {'input_1'}
    OutputNames: {'yolov2OutputLayer'}
```

Visualize the network using the network analyzer.

```
analyzeNetwork(lgraph)
```

Estimate Anchor Boxes From Training Data

Anchor boxes are important parameters of deep learning object detectors such as Faster R-CNN and YOLO v2. The shape, scale, and number of anchor boxes impact the efficiency and accuracy of the detectors.

For more information, see “Anchor Boxes for Object Detection”.

Load Training Data

Load the vehicle dataset, which contains 295 images and associated box labels.

```
data = load('vehicleTrainingData.mat');
vehicleDataset = data.vehicleTrainingData;
```

Add the full path to the local vehicle data folder.

```
dataDir = fullfile(toolboxdir('vision'),'visiondata');
vehicleDataset.imageFilename = fullfile(dataDir,vehicleDataset.imageFilename);
```

Display the data set summary.

```
summary(vehicleDataset)
```

Variables:

```
imageFilename: 295x1 cell array of character vectors
vehicle: 295x1 cell
```

Visualize Ground Truth Box Distribution

Visualize the labeled boxes to better understand the range of object sizes present in the data set.

Combine all the ground truth boxes into one array.

```
allBoxes = vertcat(vehicleDataset.vehicle{:});
```

Plot the box area versus the box aspect ratio.

```
aspectRatio = allBoxes(:,3) ./ allBoxes(:,4);
area = prod(allBoxes(:,3:4),2);
```

```
figure
scatter(area,aspectRatio)
xlabel("Box Area")
ylabel("Aspect Ratio (width/height)");
title("Box Area vs. Aspect Ratio")
```

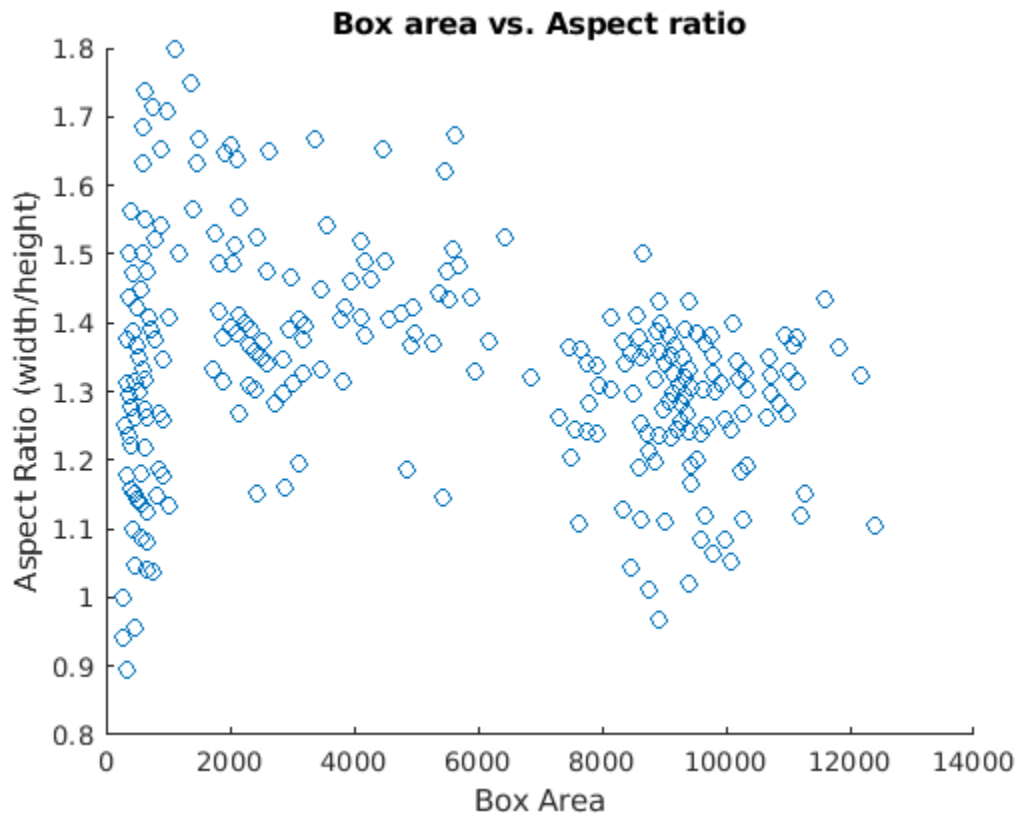

The plot shows a few groups of objects that are of similar size and shape. However, because the groups are spread out, manually choosing anchor boxes is difficult. A better way to estimate anchor boxes is to use a clustering algorithm that can group similar boxes together using a meaningful metric.

Estimate Anchor Boxes

Estimate anchor boxes from training data using the `estimateAnchorBoxes` function, which uses the intersection-over-union (IoU) distance metric.

A distance metric based on IoU is invariant to the size of boxes, unlike the Euclidean distance metric, which produces larger errors as the box sizes increase [1]. In addition, using an IoU distance metric leads to boxes of similar aspect ratios and sizes being clustered together, which results in anchor box estimates that fit the data.

Create a `boxLabelDatastore` using the ground truth boxes in the vehicle data set. If the preprocessing step for training an object detector involves resizing of the images, use `transform`

and `bboxresize` to resize the bounding boxes in the `boxLabelDatastore` before estimating the anchor boxes.

```
trainingData = boxLabelDatastore(vehicleDataset(:,2:end));
```

Select the number of anchors and estimate the anchor boxes using `estimateAnchorBoxes` function.

```
numAnchors = 5  ;
[anchorBoxes,meanIoU] = estimateAnchorBoxes(trainingData,numAnchors);
anchorBoxes
```

```
anchorBoxes = 5x2
```

```
21    27
87   116
67    92
43    61
86   105
```

Choosing the number of anchors is another training hyperparameter that requires careful selection using empirical analysis. One quality measure for judging the estimated anchor boxes is the mean IoU of the boxes in each cluster. The `estimateAnchorBoxes` function uses a k -means clustering algorithm with the IoU distance metric to calculate the overlap using the equation, $1 - \text{bboxOverlapRatio}(\text{allBoxes}, \text{boxInCluster})$.

```
meanIoU
```

```
meanIoU = 0.8411
```

The mean IoU value greater than 0.5 ensures that the anchor boxes overlap well with the boxes in the training data. Increasing the number of anchors can improve the mean IoU measure. However, using more anchor boxes in an object detector can also increase the computation cost and lead to overfitting, which results in poor detector performance.

Sweep over a range of values and plot the mean IoU versus number of anchor boxes to measure the trade-off between number of anchors and mean IoU.

```
maxNumAnchors = 15;
meanIoU = zeros([maxNumAnchors,1]);
anchorBoxes = cell(maxNumAnchors, 1);
for k = 1:maxNumAnchors
    % Estimate anchors and mean IoU.
    [anchorBoxes{k},meanIoU(k)] = estimateAnchorBoxes(trainingData,k);
end

figure
plot(1:maxNumAnchors,meanIoU,'-o')
ylabel("Mean IoU")
xlabel("Number of Anchors")
title("Number of Anchors vs. Mean IoU")
```

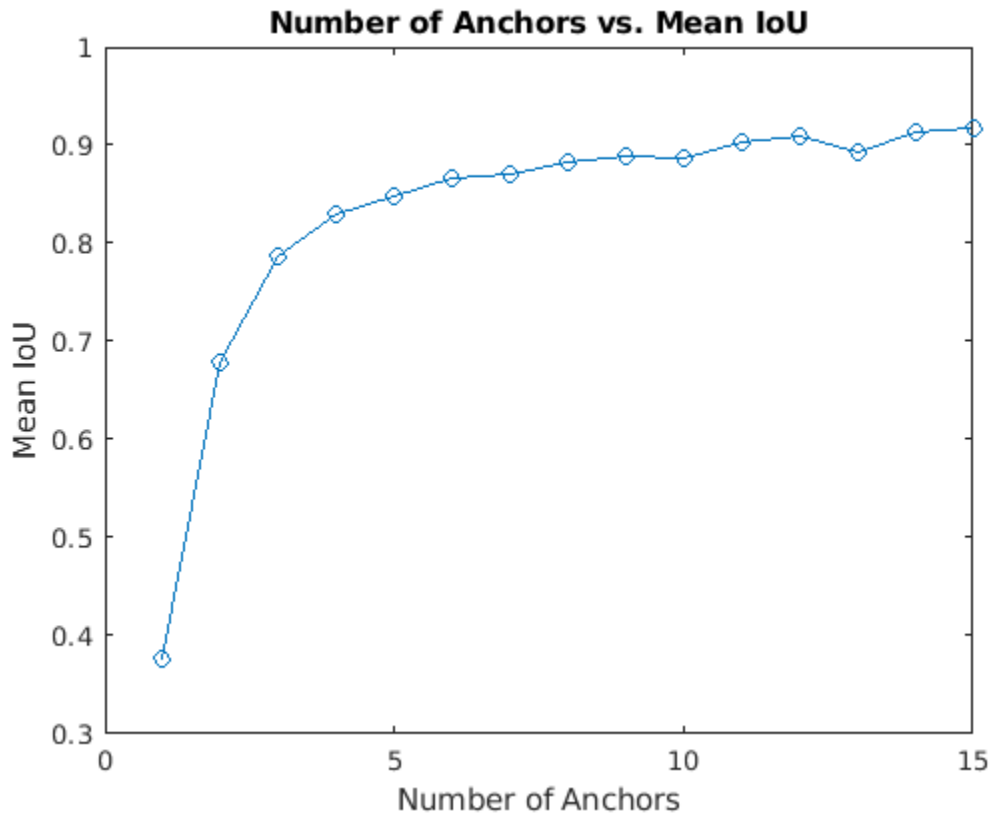

Using two anchor boxes results in a mean IoU value greater than 0.65, and using more than 7 anchor boxes yields only marginal improvement in mean IoU value. Given these results, the next step is to train and evaluate multiple object detectors using values between 2 and 6. This empirical analysis helps determine the number of anchor boxes required to satisfy application performance requirements, such as detection speed, or accuracy.

Input Arguments

trainingData — Training data

datastore

Training data, specified as a datastore that returns a cell array or table with two or more columns. The bounding boxes must be in a cell array of M -by-4 matrices in the format $[x,y,width,height]$.

The datastore must be one of the following:

- A `boxLabelDatastore` in the format $[boxes,labels]$
- $\{images,boxes,labels\}$ — A combined datastore. For example, using `combine(imds,blds)`.

numAnchors — Number of anchor boxes

integer

Number of anchor boxes for the function to return, specified as an integer.

Output Arguments

anchorBoxes — Anchor boxes

N-by-2 matrix

Anchor boxes, returned as an *N*-by-2 matrix, where *N* is the number of anchor boxes and each entry has the format [*height*, *width*]. Use `numAnchors` to specify the number of anchor boxes.

meanIoU — Distance metric

scalar

Distance metric, returned as a scalar value. The distance metric provides the mean intersection-over-union (IoU) value of the anchor boxes in each cluster. To ensure anchor boxes overlap well with the boxes in the training data, the `meanIoU` value must be greater than 0.5. The *k*-means clustering algorithm uses the IoU distance metric to calculate the overlap using the equation `1-bboxOverlapRatio(box1,box2)`.

See Also

Objects

`boxLabelDatastore` | `fasterRCNNObjectDetector`

Functions

`yoloV2Layers`

Topics

“Anchor Boxes for Object Detection”

“Datastores for Deep Learning” (Deep Learning Toolbox)

“Training Data for Object Detection and Semantic Segmentation”

Introduced in R2019b

deeplabv3plusLayers

Create DeepLab v3+ convolutional neural network for semantic image segmentation

Syntax

```
layerGraph = deeplabv3plusLayers(imageSize,numClasses,network)
layerGraph = deeplabv3plusLayers( ___, 'DownsamplingFactor',value)
```

Description

`layerGraph = deeplabv3plusLayers(imageSize,numClasses,network)` returns a DeepLab v3+ layer with the specified base network, number of classes, and image size.

`layerGraph = deeplabv3plusLayers(___, 'DownsamplingFactor',value)` additionally sets the downsampling factor (output stride) [1] to either 8 or 16. The downsampling factor sets the amount the encoder section of DeepLab v3+ downsamples the input image.

Examples

Create DeepLab v3+ Network Based on ResNet-18

Create a DeepLab v3+ network based on ResNet-18.

```
imageSize = [480 640 3];
numClasses = 5;
network = 'resnet18';
lgraph = deeplabv3plusLayers(imageSize,numClasses,network, ...
    'DownsamplingFactor',16);
```

Display the network.

```
analyzeNetwork(lgraph)
```

Train DeepLab v3+ Network

Load the triangle data set images using an image datastore. The datastore contains 200 grayscale images of random triangles. Each image is 32-by-32.

```
dataSetDir = fullfile(toolboxdir('vision'),'visiondata','triangleImages');
imageDir = fullfile(dataSetDir,'trainingImages');
imds = imageDatastore(imageDir);
```

Load the triangle data set pixel labels using a pixel label datastore.

```
labelDir = fullfile(dataSetDir, 'trainingLabels');
classNames = ["triangle","background"];
labelIDs = [255 0];
pxds = pixelLabelDatastore(labelDir,classNames,labelIDs);
```

Create a DeepLab v3+ network.

```
imageSize = [256 256];
numClasses = numel(classNames);
lgraph = deeplabv3plusLayers(imageSize,numClasses,'resnet18');
```

Combine image and pixel label data for training and apply a preprocessing transform to resize the training images.

```
cds = combine(imds,pxds);
tds = transform(cds, @(data)preprocessTrainingData(data,imageSize));
```

Specify training options. Lower the mini-batch size to reduce memory usage.

```
opts = trainingOptions('sgdm',...
    'MiniBatchSize',8,...
    'MaxEpochs',3);
```

Train the network.

```
net = trainNetwork(tds,lgraph,opts);
```

Training on single GPU.
Initializing input data normalization.

Epoch	Iteration	Time Elapsed (hh:mm:ss)	Mini-batch Accuracy	Mini-batch Loss	Base Learning Rate
1	1	00:00:00	34.79%	0.9817	0.0100
2	50	00:00:23	99.02%	0.0261	0.0100
3	75	00:00:31	99.16%	0.0211	0.0100

Read a test image.

```
I = imread('triangleTest.jpg');
```

Resize the test image by a factor equal to the input image size divided by 32 so that the triangles in the test image are roughly equal to the size of the triangles during training.

```
I = imresize(I,'Scale',imageSize./32);
```

Segment the image.

```
C = semanticseg(I,net);
```

Display the results.

```
B = labeloverlay(I,C);
figure
imshow(B)
```

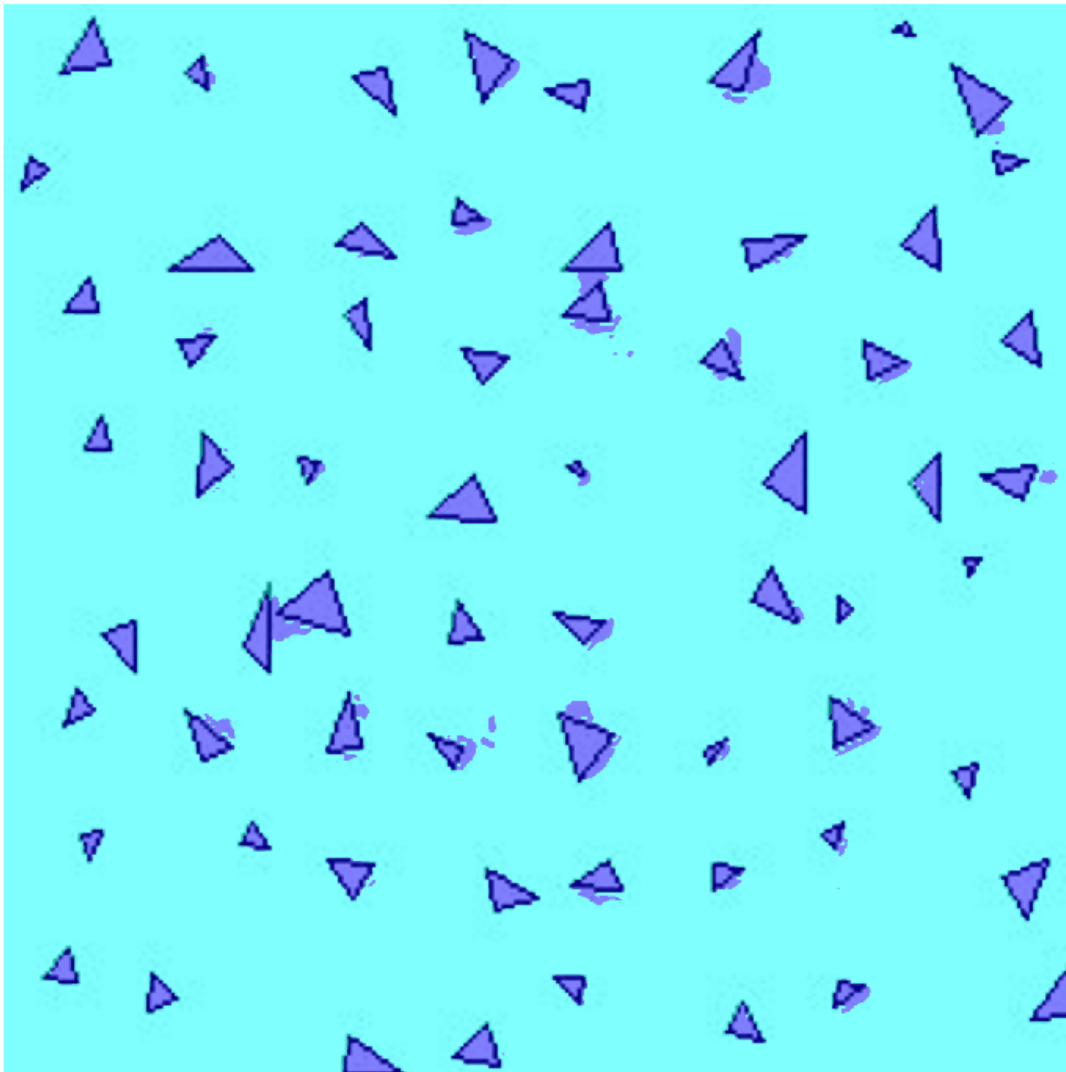
Supporting Functions

```
function data = preprocessTrainingData(data, imageSize)
% Resize the training image and associated pixel label image.
data{1} = imresize(data{1},imageSize);
data{2} = imresize(data{2},imageSize);

% Convert grayscale input image into RGB for use with ResNet-18, which
% requires RGB image input.
```

```
data{1} = repmat(data{1},1,1,3);  
end
```

Input Arguments

imageSize — Network input image size

2-element vector | 3-element vector

Network input image size, specified as a:

- 2-element vector in the format [*height*, *width*].
- 3-element vector in the format [*height*, *width*, 3]. The third element, 3, corresponds to RGB.

numClasses — Number of classes

integer greater than 1

Number of classes for network to classify, specified as an integer greater than 1.

network — Base network

'resnet18' | 'resnet50' | 'mobilenetv2' | 'xception' | 'inceptionresnetv2'

Base network, specified as `resnet18`, `resnet50`, `mobilenetv2`, `xception`, or `inceptionresnetv2`. You must install the corresponding network add-on.

Output Arguments

layerGraph — DeepLab v3+ network

layer graph

DeepLab v3+ network, returned as a convolutional neural network for semantic image segmentation. The network uses encoder-decoder architecture, dilated convolutions, and skip connections to segment images. You must use the `trainNetwork` function (requires Deep Learning Toolbox) to train the network before you can use the network for semantic segmentation.

Algorithms

- When you use either the `xception` or `mobilenetv2` base networks to create a DeepLab v3+ network, depth separable convolutions are used in the atrous spatial pyramid pooling (ASPP) and decoder subnetworks. For all other base networks, convolution layers are used.
- This implementation of DeepLab v3+ does not include a global average pooling layer in the ASPP.

References

- [1] Chen, L., Y. Zhu, G. Papandreou, F. Schroff, and H. Adam. "Encoder-Decoder with Atrous Separable Convolution for Semantic Image Segmentation." *Computer Vision — ECCV 2018*, 833-851. Munic, Germany: ECCV, 2018.

Extended Capabilities

GPU Code Generation

Generate CUDA® code for NVIDIA® GPUs using GPU Coder™.

Usage notes and limitations:

For code generation, you must first create a DeepLab v3+ network by using the `deeplabv3plusLayers` function. Then, use the `trainNetwork` function on the resulting `lgraph` object to train the network for segmentation. Once the network is trained and evaluated, you can generate code for the deep learning network object using GPU Coder.

See Also

Objects

`pixelClassificationLayer` | `layerGraph`

Functions

`fcnLayers` | `segnetLayers` | `unetLayers` | `trainNetwork` | `semanticseg`

Topics

“Getting Started with Semantic Segmentation Using Deep Learning”

“Deep Learning in MATLAB” (Deep Learning Toolbox)

Introduced in R2019b

fasterRCNNLayers

Create a faster R-CNN object detection network

Syntax

```
lgraph = fasterRCNNLayers(inputImageSize,numClasses,anchorBoxes,network)
lgraph = fasterRCNNLayers(inputImageSize,numClasses,anchorBoxes,network,
featureLayer)
lgraph = fasterRCNNLayers( ___,Name,Value)
```

Description

`lgraph = fasterRCNNLayers(inputImageSize,numClasses,anchorBoxes,network)` returns a Faster R-CNN network as a `layerGraph` object. A Faster R-CNN network is a convolutional neural network based object detector. The detector predicts the coordinates of bounding boxes, objectness scores, and classification scores for a set of anchor boxes. To train the created network, use the `trainFasterRCNNObjectDetector` function. For more information, see “Getting Started with R-CNN, Fast R-CNN, and Faster R-CNN”.

`lgraph = fasterRCNNLayers(inputImageSize,numClasses,anchorBoxes,network,featureLayer)` returns the object detection network based on the specified `featureLayer` of the network. Use this syntax when you specify the network as a `SeriesNetwork`, `DAGNetwork`, or `layerGraph` object.

`lgraph = fasterRCNNLayers(___,Name,Value)` returns the object detection network with optional input properties specified by one or more name-value pair arguments.

Using this function requires Deep Learning Toolbox.

Examples

Create a Faster R-CNN Object Detection Network

Specify the image size.

```
inputImageSize = [224 224 3];
```

Specify the number of objects to detect.

```
numClasses = 1;
```

Use a pretrained ResNet-50 network as the base network for the Faster R-CNN network. You must download the `resnet50` (Deep Learning Toolbox) support package.

```
network = 'resnet50';
```

Specify the network layer to use for feature extraction. You can use the `analyzeNetwork` (Deep Learning Toolbox) function to see all the layer names in a network.

```
featureLayer = 'activation_40_relu';
```

Specify the anchor boxes. You can also use the `estimateAnchorBoxes` function to estimate anchor boxes from your training data.

```
anchorBoxes = [64,64; 128,128; 192,192];
```

Create the Faster R-CNN object detection network.

```
lgraph = fasterRCNNLayers(inputImageSize,numClasses,anchorBoxes, ...
    network,featureLayer)
```

```
lgraph =
  LayerGraph with properties:

    Layers: [188x1 nnet.cnn.layer.Layer]
    Connections: [205x2 table]
    InputNames: {'input_1'}
    OutputNames: {1x4 cell}
```

Visualize the network using the network analyzer.

```
analyzeNetwork(lgraph)
```

Input Arguments

inputImageSize — Network input image size

3-element vector

Network input image size, specified as a 3-element vector in the format $[height, width, depth]$. $depth$ is the number of image channels. Set $depth$ to 3 for RGB images, to 1 for grayscale images, or to the number of channels for multispectral and hyperspectral images.

numClasses — Number of classes

integer greater than 0

Number of classes for the network to classify, specified as an integer greater than 0.

anchorBoxes — Anchor boxes

M -by-2 matrix

Anchor boxes, specified as an M -by-2 matrix of M anchor boxes in the format $[height, width]$. Anchor boxes are determined based on the scale and aspect ratio of objects in the training data set. For example, if an object is localized by a square window, then you can set the size of the anchor boxes to $[64\ 64; 128\ 128]$.

network — Pretrained classification network

SeriesNetwork object | DAGNetwork object | LayerGraph object | 'alexnet' | 'vgg16' | 'vgg19' | 'resnet18' | 'resnet50' | 'resnet101' | 'inceptionv3' | 'googlenet' | 'inceptionresnetv2' | 'mobilenetv2' | 'squeezenet'

Pretrained classification network, specified as a SeriesNetwork, DAGNetwork, or layerGraph, or as on of the following:

- 'alexnet'

- 'vgg16'
- 'vgg19'
- 'resnet18'
- 'resnet50'
- 'resnet101'
- 'inceptionv3'
- 'googlenet'
- 'inceptionresnetv2'
- 'squeezenet'
- 'mobilenetv2'

When you specify the network as a `SeriesNetwork` object, a `DAGNetwork` object, or by name, the function transforms the network into a Faster R-CNN network. It transforms the network by adding a region proposal network (RPN), and ROI max pooling layer, and new classification and regression layers to support object detection.

featureLayer — Feature extraction layer

character vector | string scalar

Feature extraction layer, specified as a character vector or a string scalar. Use one of the deeper layers in the network you specify. You can use the `analyzeNetwork` function to view the names of the layers in the input network.

Note You can specify any network layer except the fully connected layer as the feature layer.

Name-Value Pair Arguments

Specify optional comma-separated pairs of `Name`, `Value` arguments. `Name` is the argument name and `Value` is the corresponding value. `Name` must appear inside quotes. You can specify several name and value pair arguments in any order as `Name1, Value1, ..., NameN, ValueN`.

Example: `'ROIMaxPoolingLayer', 'auto'`

ROIMaxPoolingLayer — ROI max pooling layer

'auto' (default) | 'insert' | 'replace'

ROI max pooling layer, specified as a `'auto'`, `'insert'`, or `'replace'`. You can specify whether a `roiMaxPooling2dLayer` replaces the pooling layer or follows the feature extraction layer.

If you select `'auto'`, the function:

- Inserts a new ROI max pooling layer after the feature extraction layer when the layer next to the feature extraction layer is not a max pooling layer.
- Replaces the current pooling layer after the feature extraction layer with an ROI max pooling layer.

ROIOutputSize — ROI max pooling layer output size

'auto' (default) | 2-element vector

ROI max pooling layer output size, specified as `'auto'` or a 2-element vector of positive integers. When you set the value to `'auto'`, the function determines the output size based on the

R0IMaxPoolingLayer property. It uses the output size of the feature extraction layer or the pooling layer following the feature extraction layer.

Output Arguments

lgraph — Object detection network

LayerGraph object

Object detection network, returned as a layerGraph object. The output and base network imageInputLayer normalization values are equal.

See Also

Apps

Deep Network Designer

Functions

trainFasterRCNNObjectDetector | fasterRCNNObjectDetector | estimateAnchorBoxes | analyzeNetwork | yolov2Layers

Topics

“Estimate Anchor Boxes From Training Data”

“Anchor Boxes for Object Detection”

“Getting Started with R-CNN, Fast R-CNN, and Faster R-CNN”

Introduced in R2019b

yolov2Layers

Create YOLO v2 object detection network

Syntax

```
lgraph = yolov2Layers(imageSize,numClasses,anchorBoxes,network,featureLayer)  
lgraph = yolov2Layers( ____, 'ReorgLayerSource', reorgLayer)
```

Description

`lgraph = yolov2Layers(imageSize,numClasses,anchorBoxes,network,featureLayer)` creates a YOLO v2 object detection network and returns it as a `LayerGraph` object.

`lgraph = yolov2Layers(____, 'ReorgLayerSource', reorgLayer)` specifies the source of reorganization layer by using a name-value pair. You can specify this name-value pair to add reorganization layer to the YOLO v2 network architecture. Specify this argument in addition to the input arguments in the previous syntax.

Examples

Create YOLO v2 Network for Object Detection

Specify the size of the input image for training the network.

```
imageSize = [224 224 3];
```

Specify the number of object classes the network has to detect.

```
numClasses = 1;
```

Define the anchor boxes.

```
anchorBoxes = [1 1;4 6;5 3;9 6];
```

Specify the pretrained ResNet -50 network as the base network for YOLO v2. To use this pretrained network, you need to install the 'Deep Learning Toolbox Model for ResNet-50 Network' support package.

```
network = resnet50();
```

Analyze the network architecture to view all the network layers.

```
analyzeNetwork(network)
```

network 177 layers 0 warnings 0 errors

Analysis date: 07-Jan-2019 17:17:23

ANALYSIS RESULT

	Name	Type	Activations	Learn
161	bn5b_branch2c Batch normalization with 2048 channels	Batch Normalization	7*7*2048	Off Sca
162	add_15 Element-wise addition of 2 inputs	Addition	7*7*2048	-
163	activation_46_relu ReLU	ReLU	7*7*2048	-
164	res5c_branch2a 512 1x1x2048 convolutions with stride [1 1] and p...	Convolution	7*7*512	Wei Bia
165	bn5c_branch2a Batch normalization with 512 channels	Batch Normalization	7*7*512	Off Sca
166	activation_47_relu ReLU	ReLU	7*7*512	-
167	res5c_branch2b 512 3x3x512 convolutions with stride [1 1] and pa...	Convolution	7*7*512	Wei Bia
168	bn5c_branch2b Batch normalization with 512 channels	Batch Normalization	7*7*512	Off Sca
169	activation_48_relu ReLU	ReLU	7*7*512	-
170	res5c_branch2c 2048 1x1x512 convolutions with stride [1 1] and p...	Convolution	7*7*2048	Wei Bia
171	bn5c_branch2c Batch normalization with 2048 channels	Batch Normalization	7*7*2048	Off Sca
172	add_16 Element-wise addition of 2 inputs	Addition	7*7*2048	-
173	activation_49_relu ReLU	ReLU	7*7*2048	-
174	avg_pool 7x7 average pooling with stride [7 7] and padding ...	Average Pooling	1*1*2048	-
175	fc1000 1000 fully connected layer	Fully Connected	1*1*1000	Wei Bia
176	fc1000_softmax softmax	Softmax	1*1*1000	-
177	ClassificationLayer_fc1000 crossentropyex with 'tanh' and 999 other classes	Classification Output	-	-

Specify the network layer to be used for feature extraction. You can choose any layer except the fully connected layer as feature layer.

```
featureLayer = 'activation_49_relu';
```

Create the YOLO v2 object detection network. The network is returned as a LayerGraph object.

```
lgraph = yolov2Layers(imageSize,numClasses,anchorBoxes,network,featureLayer);
```

Analyze the YOLO v2 network architecture. The layers succeeding the feature layer are removed. A series of convolution, ReLU, and batch normalization layers along with the YOLO v2 transform and YOLO v2 output layers are added to the feature layer of the base network.

```
analyzeNetwork(lgraph)
```

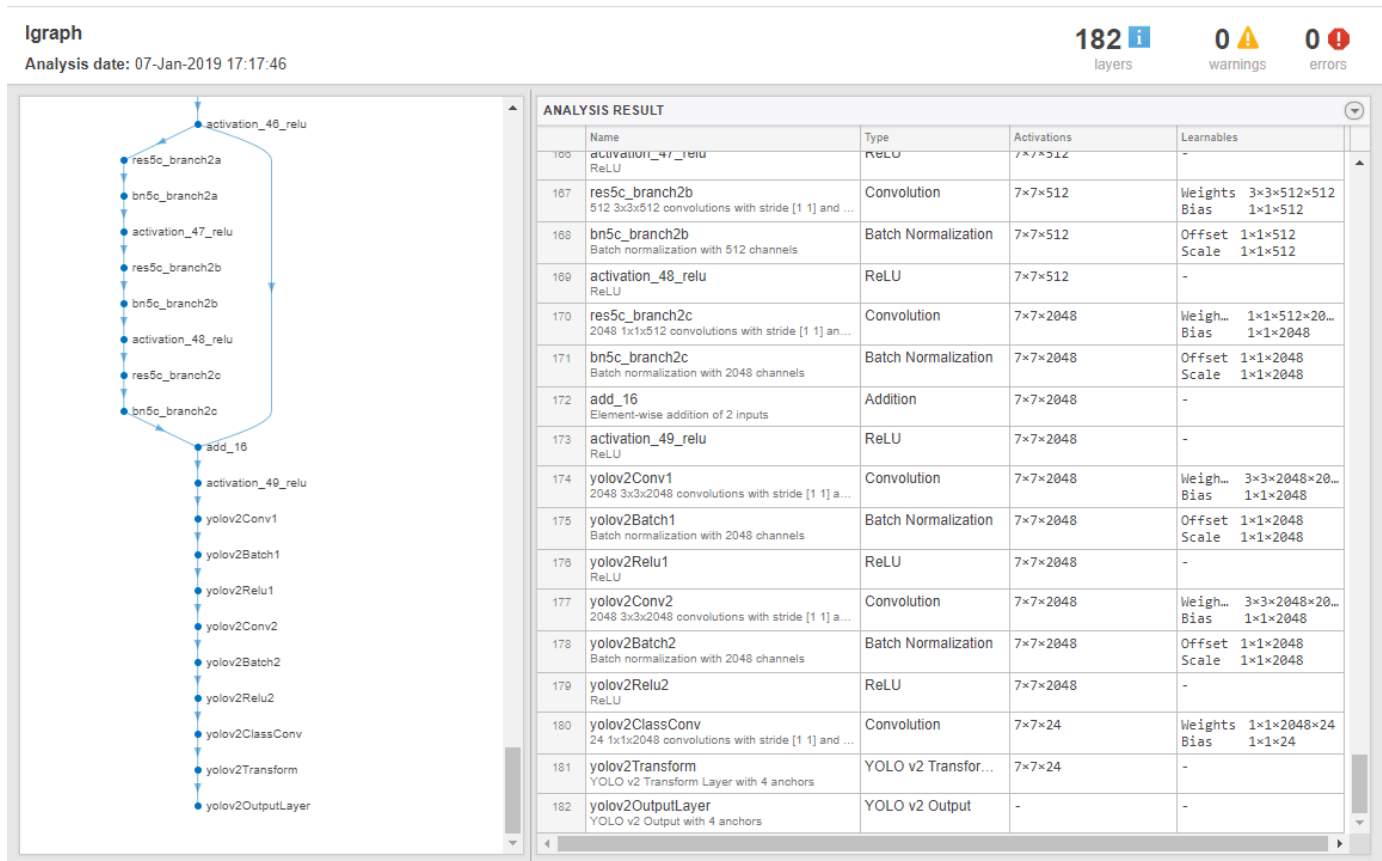

Create YOLO v2 Network with Reorganization Layer

Specify the size of the input image for training the network.

```
imageSize = [224 224 3];
```

Specify the number of object classes the network has to detect.

```
numClasses = 1;
```

Define the anchor boxes.

```
anchorBoxes = [1 1;4 6;5 3;9 6];
```

Specify the pretrained ResNet -50 as base network for YOLO v2. To use this pretrained network, you need to install the 'Deep Learning Toolbox Model for ResNet-50 Network' support package.

```
network = resnet50();
```

Analyze the network architecture to view all the network layers.

```
analyzeNetwork(network)
```

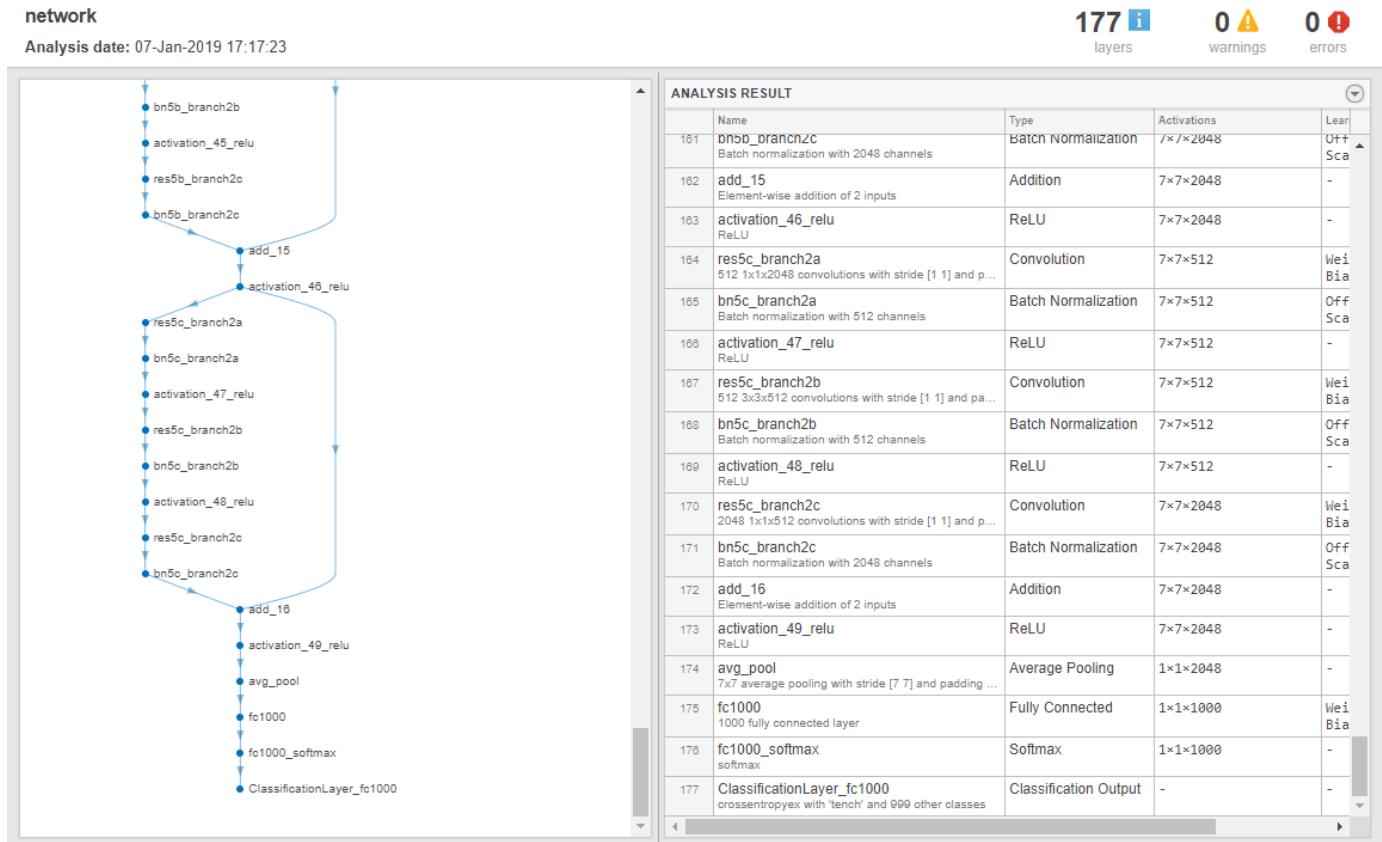

Specify the network layer to be used for feature extraction. You can choose any layer except the fully connected layer as feature layer.

```
featureLayer = 'activation_49_relu';
```

Specify the network layer to be used as the source for reorganization layer.

```
reorgLayer = 'activation_47_relu';
```

Create the YOLO v2 object detection network. The network is returned as a LayerGraph object.

```
lgraph = yolov2Layers(imageSize,numClasses,anchorBoxes,network,featureLayer,'ReorglayerSource',reorgLayer);
```

Analyze the YOLO v2 network architecture. The layers succeeding the feature layer are removed. The detection subnetwork along with the YOLO v2 transform and YOLO v2 output layers are added to the feature layer of base network. The reorganization layer and the depth concatenation layer are also added to the network. The YOLO v2 reorg layer reorganizes the dimension of output features from activation_47_relu layer. The depth concatenation layer concatenates the output of the reorganization layer with the output of a higher layer.

```
analyzeNetwork(lgraph)
```

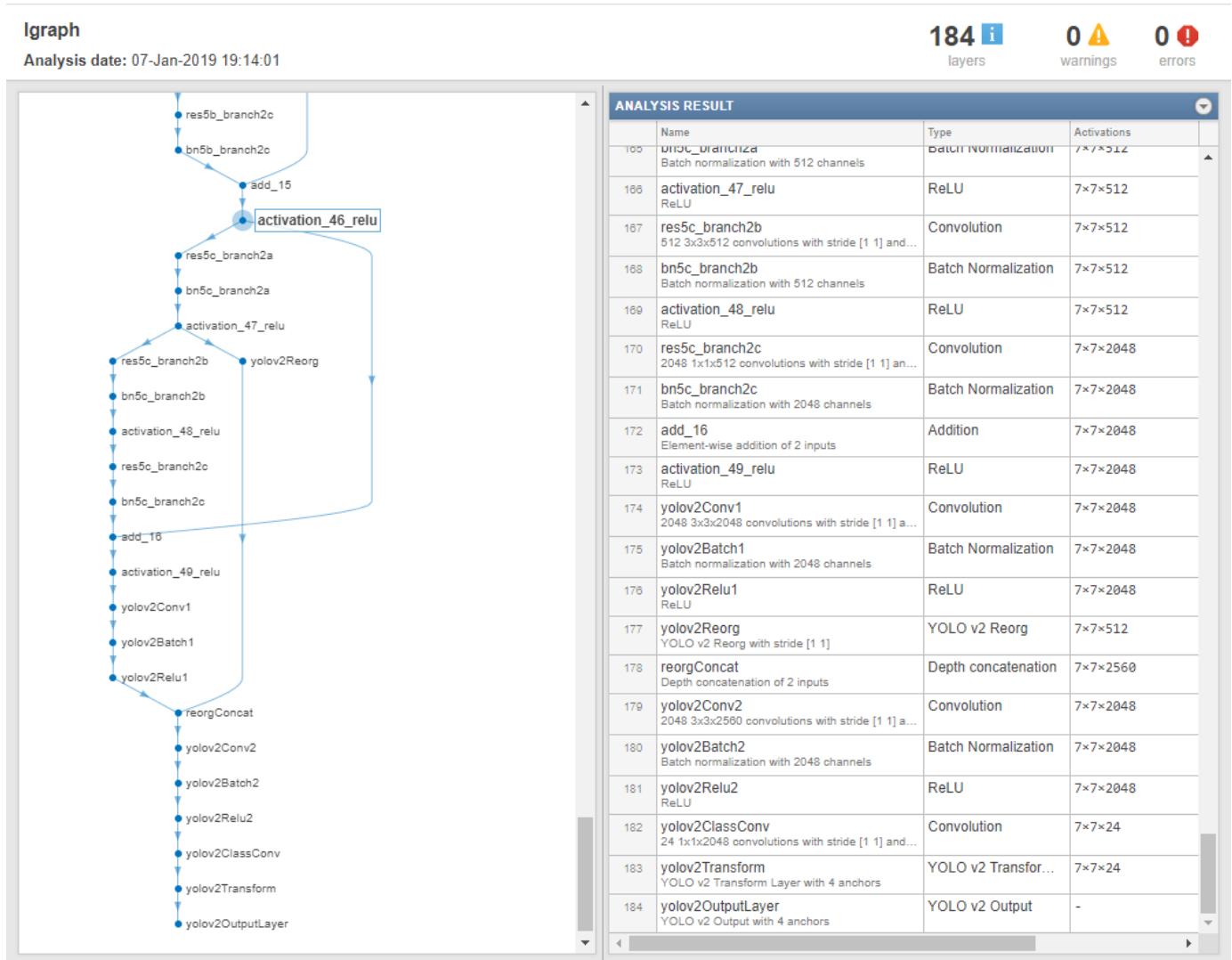

Input Arguments

imageSize — Size of input image

two-element vector | three-element vector

Size of input image, specified as one of these values:

- Two-element vector of form $[H\ W]$ - For a grayscale image of size H -by- W
- Three-element vector of form $[H\ W\ 3]$ - For an RGB color image of size H -by- W

numClasses — Number of object classes

positive integer

Number of object classes, specified as a positive integer.

anchorBoxes — Anchor boxes

M -by-2 matrix

Anchor boxes, specified as an M -by-2 matrix defining the size and the number of anchor boxes. Each row in the M -by-2 matrix denotes the size of the anchor box in the form of $[height\ width]$. M denotes the number of anchor boxes. This input sets the `AnchorBoxes` property of the output layer.

The size of each anchor box is determined based on the scale and aspect ratio of different object classes present in input training data. Also, the size of each anchor box must be smaller than or equal to the size of the input image. You can use the clustering approach for estimating anchor boxes from the training data. For more information, see “Estimate Anchor Boxes From Training Data”.

network — Pretrained convolutional neural network

LayerGraph object | DAGNetwork object | SeriesNetwork object

Pretrained convolutional neural network, specified as an `LayerGraph`, `DAGNetwork`, or `SeriesNetwork` object. This pretrained convolutional neural network is used as the base for the YOLO v2 object detection network. For details on pretrained networks in MATLAB, see “Pretrained Deep Neural Networks” (Deep Learning Toolbox).

featureLayer — Name of feature layer

character vector | string scalar

Name of feature layer, specified as a character vector or a string scalar. The name of one of the deeper layers in the `network` to be used for feature extraction. The features extracted from this layer are given as input to the YOLO v2 object detection subnetwork. You can use the `analyzeNetwork` function to view the names of the layers in the input network.

Note You can specify any network layer except the fully connected layer as the feature layer.

reorgLayer — Name of reorganization layer

character vector | string scalar

Name of reorganization layer, specified as a character vector or a string scalar. The name of one of the deeper layers in the `network` to be used as input to the reorganization layer. You can use the `analyzeNetwork` function to view the names of the layers in the input network. The reorganization layer is the pass-through layer that reorganizes the dimension of low layer features to facilitate concatenation with high layer features.

Note The input to the reorganization layer must be from any one of the network layers that lie above the feature layer.

Output Arguments

lgraph — YOLO v2 object detection network

LayerGraph object

YOLO v2 object detection network, returned as a `LayerGraph` object.

Note The default value for the `Normalization` property of the image input layer in the returned `lgraph` object is set to the `Normalization` property of the base network specified in `network`.

Algorithms

The `yoloV2Layers` function creates a YOLO v2 network, which represents the network architecture for YOLO v2 object detector. Use the `trainYOLOv2ObjectDetector` function to train the YOLO v2 network for object detection. The function returns an object that generates the network architecture for YOLO v2 object detection network presented in [1] and [2].

`yoloV2Layers` uses a pretrained neural network as the base network to which it adds a detection subnetwork required for creating a YOLO v2 object detection network. Given a base network, `yoloV2Layers` removes all the layers succeeding the feature layer in the base network and adds the detection subnetwork. The detection subnetwork comprises of groups of serially connected convolution, ReLU, and batch normalization layers. The YOLO v2 transform layer and YOLO v2 output layer are added to the detection subnetwork. If you specify the name-value pair 'ReorgLayerSource', the YOLO v2 network concatenates the output of reorganization layer with the output of feature layer.

For information on creating a custom YOLO v2 network layer-by-layer, see “Create YOLO v2 Object Detection Network”.

References

- [1] Joseph. R, S. K. Divvala, R. B. Girshick, and F. Ali. "You Only Look Once: Unified, Real-Time Object Detection." In *Proceedings of the IEEE Conference on Computer Vision and Pattern Recognition (CVPR)*, pp. 779–788. Las Vegas, NV: CVPR, 2016.
- [2] Joseph. R and F. Ali. "YOLO 9000: Better, Faster, Stronger." In *Proceedings of the IEEE Conference on Computer Vision and Pattern Recognition (CVPR)*, pp. 6517–6525. Honolulu, HI: CVPR, 2017.

Extended Capabilities

GPU Code Generation

Generate CUDA® code for NVIDIA® GPUs using GPU Coder™.

Usage notes and limitations:

For code generation, you must first create a YOLO v2 network by using the `yoloV2Layers` function. Then, use the `trainYOLOv2ObjectDetector` function on the resulting `lgraph` object to train the network for object detection. Once the network is trained and evaluated, you can generate code for the `yoloV2ObjectDetector` object using GPU Coder.

See Also

`trainYOLOv2ObjectDetector` | `spaceToDepthLayer` | `yoloV2OutputLayer` | `yoloV2TransformLayer` | `yoloV2ObjectDetector` | `analyzeNetwork` | `resnet50`

Topics

- “Create YOLO v2 Object Detection Network”
- “Object Detection Using YOLO v2 Deep Learning”
- “Estimate Anchor Boxes From Training Data”
- “Code Generation for Object Detection by Using YOLO v2”
- “Getting Started with YOLO v2”
- “Anchor Boxes for Object Detection”

Introduced in R2019a

gatherLabelData

Gather label data from ground truth

Syntax

```
labelData = gatherLabelData(gTruth,typeOfLabel)
[labelData,timestamps] = gatherLabelData( ___ )
[ ___ ] = gatherLabelData( ___ ,Name,Value)
```

Description

`labelData = gatherLabelData(gTruth,typeOfLabel)` returns label data gathered from ground truth data, `gTruth`. The function returns label data specified by `typeOfLabel`.

`[labelData,timestamps] = gatherLabelData(___)` additionally returns the image timestamps associated with the gathered label data, using the arguments from the previous syntax.

`[___] = gatherLabelData(___ ,Name,Value)` uses `Name,Value` pair arguments to specify how to gather data.

Examples

Gather Polygon Labels

Gather all of the polygon labels from the groundtruth image.

```
data = load('groundtruthVisionTeam.mat');
gtruth = data.groundtruthVisionTeam;
```

Gather all of the polygon objects.

```
labelData = gatherLabelData(gtruth, labelType('Polygon'), 'GroupLabelData', 'LabelType');
```

```
polygons = labelData{1}.PolygonData{1}(:,1);
polygonLabels = labelData{1}.PolygonData{1}(:,2);
```

Visualize the polygon labels.

```
im = imread('visionteam.jpg');
imshow(im);
showShape('polygon', polygons, 'Label', polygonLabels);
```

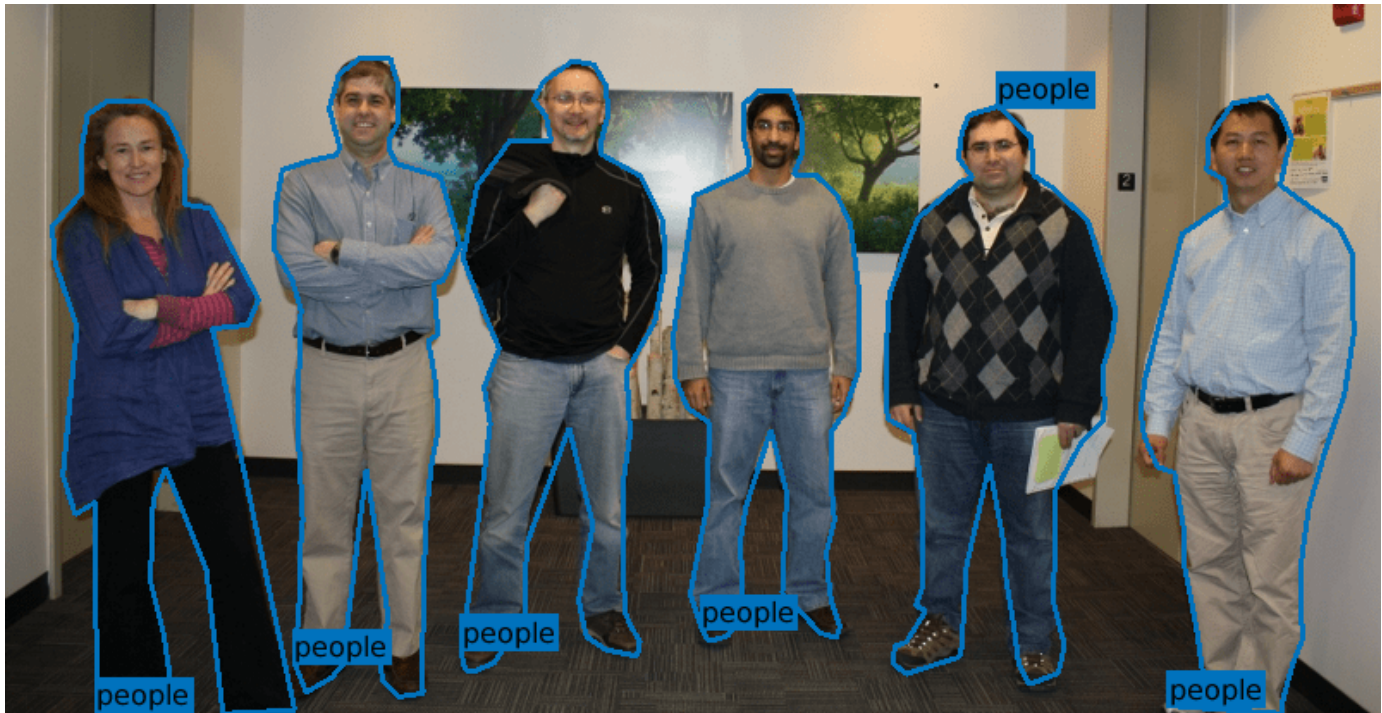
Input Arguments

gTruth — Ground truth data

groundTruth object | vector of groundTruth objects

Ground truth data, specified as a groundTruth object or vector of groundTruth objects.

typeOfLabel — Label types

vector of labelType objects

Label types from which to gather label data, specified as a vector of labelType objects. The gatherLabelData function gathers label data from each groundTruth object specified by input gTruth. The label data is grouped in columns either by label name or by label type, specified by the GroupLabelData name-value argument.

Valid Enumeration Types

You can specify one or more of these enumeration types.

- labelType.Rectangle — Rectangle ROI labels
- labelType.Cuboid — Cuboid ROI labels (point clouds)
- labelType.ProjectiveCuboid — Projected cuboid ROI labels (images and video data)
- labelType.Line — Line ROI labels
- labelType.PixelLabel — Pixel ROI labels
- labelType.Polygon — Pixel ROI labels
- labelType.Scene — Scene labels

To gather label data for scenes, you must specify `labelTypes` as the `labelType.Scene` enumeration scalar. You cannot specify any other label types with `labelType.Scene`.

Name-Value Pair Arguments

Specify optional comma-separated pairs of `Name`, `Value` arguments. `Name` is the argument name and `Value` is the corresponding value. `Name` must appear inside quotes. You can specify several name and value pair arguments in any order as `Name1, Value1, ..., NameN, ValueN`.

Example: `SampleFactor=5` drops every 5th frame.

SampleFactor — Sample factor

1 (default) | positive integer

Sample factor to subsample label data, specified as a positive integer. A sample factor of K includes every K th frame. Increase the sample factor to drop redundant frames from signals with high sample rates, such as video.

GroupLabelData — Group columns from label data

'LabelName' (default) | 'LabelType'

Group columns from label data, specified as 'LabelName' or 'LabelType'.

- 'LabelName' — Groups the label data by label definitions.
- 'LabelType' — Groups the label data by label type. This option can be used to gather label data with the region-of-interest (ROI) stacking order retained by the label type.

Output Arguments

labelData — Label data

cell array of tables

Label data, returned as an M -by-1 cell array of tables, where, M is the number of `groundTruth` objects in `gTruth`. The columns of the tables represent label data grouped by either label name or label type, specified by the `GroupLabelData` name-value argument.

For each cell in the table, the format of the returned label data depends on the type of label.

Label Type	Storage Format for Labels at Each Timestamp
<code>labelType.Rectangle</code>	<p>M-by-4 numeric matrix of the form $[x, y, w, h]$, where:</p> <ul style="list-style-type: none"> • M is the number of labels in the frame. • x and y specify the upper-left corner of the rectangle. • w specifies the width of the rectangle, which is its length along the x-axis. • h specifies the height of the rectangle, which is its length along the y-axis.

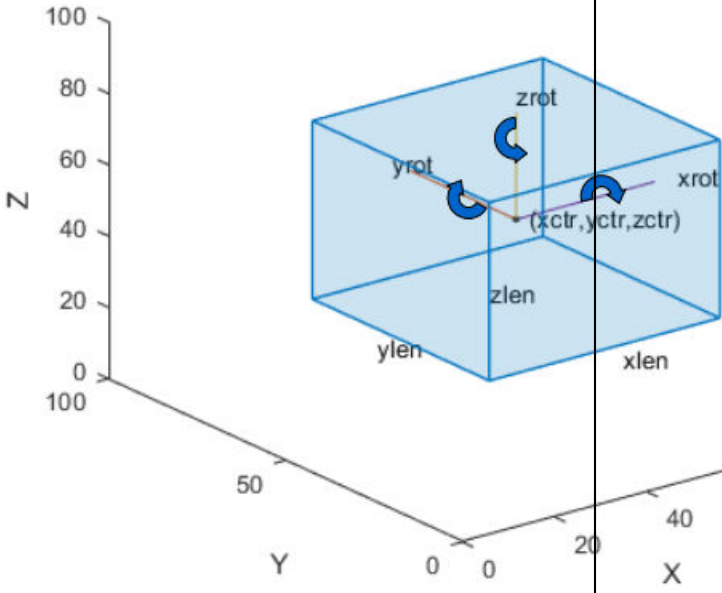
Label Type	Storage Format for Labels at Each Timestamp
labelType.Cuboid	<p>M-by-9 numeric matrix with rows of the form [xctr, yctr, zctr, xlen, ylen, zlen, xrot, yrot, zrot], where:</p> <ul style="list-style-type: none"> • M is the number of labels in the frame. • xctr, yctr, and zctr specify the center of the cuboid. • xlen, ylen, and zlen specify the length of the cuboid along the x-axis, y-axis, and z-axis, respectively, before rotation has been applied. • xrot, yrot, and zrot specify the rotation angles for the cuboid along the x-axis, y-axis, and z-axis, respectively. These angles are clockwise-positive when looking in the forward direction of their corresponding axes. <p>The figure shows how these values determine the position of a cuboid.</p> 

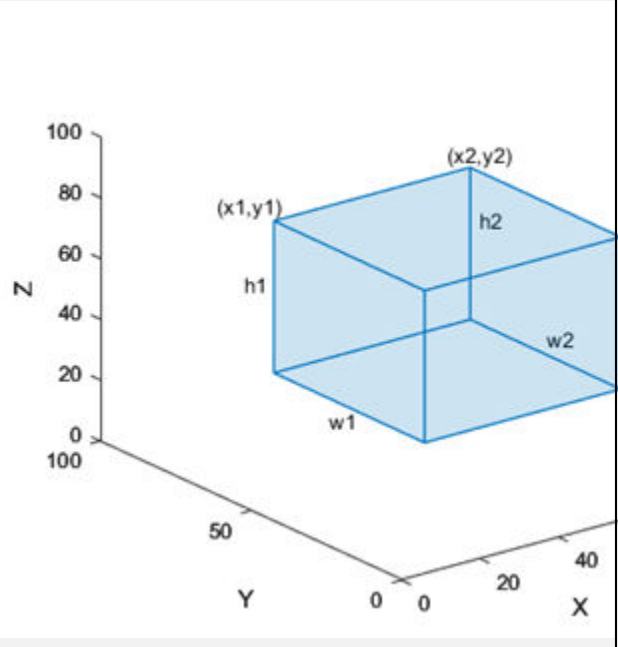
Label Type	Storage Format for Labels at Each Timestamp
<p>labelType.ProjectectedCuboid</p>	<p>M-by-8 vector of the form [x1, y1, w1, h1, x2, y2, w2, h2], where:</p> <ul style="list-style-type: none"> • M is the number of labels in the frame. • x1, y1 specifies the x,y coordinates for the upper-left location of the front-face of the projected cuboid • w1 specifies the width for the front-face of the projected cuboid. • h1 specifies the height for the front-face of the projected cuboid. • x2, y2 specifies the x,y coordinates for the upper-left location of the back-face of the projected cuboid. • w2 specifies the width for the back-face of the projected cuboid. • h2 specifies the height for the back-face of the projected cuboid. <p>The figure shows how these values determine the position of a cuboid.</p> 
<p>labelType.Line</p>	<p>M-by-1 vector of cell arrays, where M is the number of labels in the frame. Each cell array contains an N-by-2 numeric matrix of the form [x1 y1; x2 y2; ... ; xN yN] for N points in the polyline.</p>

Label Type	Storage Format for Labels at Each Timestamp
<code>labelType.PixelLabel</code>	Label data for all pixel label definitions is stored in a single M -by-1 <code>PixelLabelData</code> column for M images or frames. Each element contains a filename for a pixel label image. A pixel label image describes the label or labels contained in the corresponding image. The labels can be described as a 1- or 3- channel label matrix. To use <code>PixelLabelData</code> with any of the labeler apps, you must use a single-channel label matrix, where the values are of type <code>uint8</code> . You can convert a 3-channel pixel label data matrix to a single-channel label matrix programmatically to use with the labeler apps.
<code>labelType.Polygon</code>	M -by-1 vector of cell arrays, where M is the number of labels. Each cell array contains an N -by-2 numeric matrix of the form $[x1\ y1; x2\ y2; \dots; xN\ yN]$ for N points in the polygon.
<code>labelType.Scene</code>	Logical 1 (<code>true</code>) if the scene label is applied, otherwise logical 0 (<code>false</code>)

timestamps – Timestamps

cell array of duration vectors

Timestamps, returned as an M -by-1 cell array of duration vectors, where:

- M is the number of `groundTruth` objects in `gTruth`.
- `labelData{m}` contains the timestamps that is in the m th `groundTruth` object of `gTruth`.

Limitations

- The `gatherLabelData` function does not gather label data for sublabels or attributes. If a label contains sublabels or attributes, in the `labelData` output, the function returns the position of the parent label only.

See Also

`groundTruth` | `boxLabelDatastore`

Topics

“Label Objects Using Polygons”

Introduced in R2021a

selectLabelsByGroup

Select ground truth labels by label group

Syntax

```
gtLabel = selectLabelsByGroup(gTruth, labelGroups)
```

Description

`gtLabel = selectLabelsByGroup(gTruth, labelGroups)` selects labels belonging to the groups specified by `labelGroups` from a `groundTruth` object, `gTruth`. The function returns a corresponding `groundTruth` object, `gtLabel`, that contains only the selected labels. If `gTruth` is a vector of `groundTruth` objects, then the function returns a vector of corresponding `groundTruth` objects that contain only the selected labels.

Examples

Select Ground Truth Data By Group

Load data to create a ground truth object. Add the image folder to the path.

```
data = load('stopSignsAndCars.mat');
imageFileNames = data.stopSignsAndCars.imageFilename(1:2)

imageFileNames = 2x1 cell
    {'stopSignImages/image001.jpg'}
    {'stopSignImages/image002.jpg'}
```

```
imageFileNames = fullfile(toolboxdir('vision'),'visiondata',imageFileNames);
dataSource = groundTruthDataSource(imageFileNames);
```

Define labels for identifying ground truth data.

```
names = {'stopSign'; 'carRear'};
types = [
    labelType('Rectangle')
    labelType('Rectangle')
];
groups = {'TrafficSigns'; 'Vehicles'};

labelDefs = table(names, types, groups, 'VariableNames', {'Name', 'Type', 'Group'})
```

```
labelDefs=2x3 table
    Name          Type          Group
    _____  _____  _____
    {'stopSign'}  Rectangle    {'TrafficSigns'}
    {'carRear' }  Rectangle    {'Vehicles' }
```

Initialize label data for rectangle ROIs.

```
numRows = numel(imageFileNames);
stopSignTruth = {[856 318 39 41]; [445 523 52 54]};
carRearTruth = {[398 378 315 210]; [332 633 691 287]};
```

Construct a table containing label data.

```
labelData = table(stopSignTruth,carRearTruth,'VariableNames',names)
```

```
labelData=2x2 table
      stopSign      carRear
      _____      _____
      {[856 318 39 41]}  {[398 378 315 210]}
      {[445 523 52 54]}  {[332 633 691 287]}
```

Create a groundTruth object.

```
gTruth = groundTruth(dataSource,labelDefs,labelData)
```

```
gTruth =
  groundTruth with properties:
      DataSource: [1x1 groundTruthDataSource]
  LabelDefinitions: [2x3 table]
      LabelData: [2x2 table]
```

Select labels by group.

```
vehicleGroundTruth = selectLabelsByGroup(gTruth, 'Vehicles')
```

```
vehicleGroundTruth =
  groundTruth with properties:
      DataSource: [1x1 groundTruthDataSource]
  LabelDefinitions: [1x3 table]
      LabelData: [2x1 table]
```

Input Arguments

gTruth — Ground truth

groundTruth object | vector of groundTruth objects

Ground truth, specified as a groundTruth object or vector of groundTruth objects.

labelGroups — Label groups

character vector | string scalar | cell array of character vectors | string vector

Label groups, specified as a character vector, string scalar, cell array of character vectors, or string vector.

To view all label groups in a groundTruth object, gTruth, enter this command at the MATLAB command prompt.

```
unique(gTruth.LabelDefinitions.Group)
```

Example: 'Vehicles'

Example: "Vehicles"

Example: {'Vehicles', 'Signs'}

Example: ["Vehicles" "Signs"]

Output Arguments

gtLabel – Ground truth with only selected labels

groundTruth object | vector of groundTruth objects

Ground truth with only the selected labels, returned as a groundTruth object or vector of groundTruth objects.

Each groundTruth object in gtLabel corresponds to a groundTruth object in the gTruth input. The returned objects contain only the labels belonging to the groups specified by the labelGroups input.

See Also

Objects

groundTruth

Functions

selectLabelsByType | selectLabelsByName

Introduced in R2019a

selectLabelsByType

Select ground truth labels by label type

Syntax

```
gtLabel = selectLabelsByType(gTruth, labelTypes)
```

Description

`gtLabel = selectLabelsByType(gTruth, labelTypes)` selects labels of the types specified by `labelTypes` from a ground truth object, `gTruth`. The function returns a corresponding ground truth object, `gtLabel`, that contains only the selected labels. If `gTruth` is a vector of ground truth objects, then the function returns a vector of corresponding ground truth objects that contain only the selected labels.

Examples

Select Ground Truth Data by Types

Add the image directory to the MATLAB path.

```
imageDir = fullfile(matlabroot, 'toolbox', 'vision', 'visiondata', 'stopSignImages');
addpath(imageDir);
```

Load the ground truth object.

```
load('stopSignsAndCarsGroundTruth.mat');
```

View the label definitions.

```
stopSignsAndCarsGroundTruth.LabelDefinitions
```

```
ans=3x3 table
      Name      Type      Group
      _____  _____  _____
      {'stopSign'} Rectangle {'None'}
      {'carRear' } Rectangle {'None'}
      {'carFront'} Rectangle {'None'}
```

Obtain the ground truth data for Rectangle labelType.

```
rectGroundTruth = selectLabelsByType(stopSignsAndCarsGroundTruth, labelType.Rectangle);
```

Remove the image directory from the path.

```
rmpath(imageDir);
```

Input Arguments

gTruth — Ground truth

groundTruth object | vector of groundTruth objects

Ground truth, specified as a groundTruth object or vector of groundTruth objects.

labelTypes — Label types

labelType enumeration | vector of labelType enumerations

Label types, specified as a labelType enumeration or vector of labelType enumerations.

To view all label types in a groundTruth object, gTruth, enter this command at the MATLAB command prompt.

```
unique(gTruth.LabelDefinitions.Type)
```

Example: labelType.Rectangle

Example: [labelType.Rectangle labelType.Line]

Output Arguments

gtLabel — Ground truth with only selected labels

groundTruth object | vector of groundTruth objects

Ground truth with only the selected labels, returned as a groundTruth object or vector of groundTruth objects.

Each groundTruth object in gtLabel corresponds to a groundTruth object in the gTruth input. The returned objects contain only the labels that are of the types specified by the labelTypes input.

Limitations

- Selecting sublabels by type is not supported.

See Also

Objects

groundTruth

Functions

selectLabelsByName | selectLabelsByGroup

Introduced in R2019a

selectLabelsByName

Select ground truth labels by label name

Syntax

```
gtLabel = selectLabelsByName(gTruth, labelNames)
```

Description

`gtLabel = selectLabelsByName(gTruth, labelNames)` selects labels specified by `labelNames` from a `groundTruth` object, `gTruth`. The function returns a corresponding `groundTruth` object, `gtLabel`, that contains only the selected labels. If `gTruth` is a vector of `groundTruth` objects, then the function returns a vector of corresponding `groundTruth` objects that contain only the selected labels.

Examples

Select Ground Truth Data By Name

Add the image directory to the MATLAB path.

```
imageDir = fullfile(matlabroot, 'toolbox', 'vision', 'visiondata', 'stopSignImages');
addpath(imageDir);
```

Load the `groundTruth` object.

```
load('stopSignsAndCarsGroundTruth.mat');
```

View the label definitions.

```
stopSignsAndCarsGroundTruth.LabelDefinitions
```

```
ans=3x3 table
      Name          Type          Group
-----
{'stopSign'}      Rectangle  {'None'}
{'carRear' }      Rectangle  {'None'}
{'carFront'}      Rectangle  {'None'}
```

Obtain the ground truth data for `StopSign` label name.

```
stopSignGroundTruth = selectLabelsByName(stopSignsAndCarsGroundTruth, ...
                                         'stopSign');
```

Obtain ground truth data for `carRear` and `carFront`.

```
carGroundTruth = selectLabels(stopSignsAndCarsGroundTruth, ...
                              {'carRear', 'carFront'});
```

Remove the image directory from the path.

```
rmpath(imageDir);
```

Input Arguments

gTruth — Ground truth

groundTruth object | vector of groundTruth objects

Ground truth, specified as a groundTruth object or vector of groundTruth objects.

labelNames — Label names

character vector | string scalar | cell array of character vectors | string vector

Label names, specified as a character vector, string scalar, cell array of character vectors, or string vector.

To view all label names in a groundTruth object, gTruth, enter this command at the MATLAB command prompt.

```
gTruth.LabelDefinitions.Name
```

Example: 'car'

Example: "car"

Example: {'car', 'lane'}

Example: ["car" "lane"]

Output Arguments

gtLabel — Ground truth with only selected labels

groundTruth object | vector of groundTruth objects

Ground truth with only the selected labels, returned as a groundTruth object or vector of groundTruth objects.

Each groundTruth object in gtLabel corresponds to a groundTruth object in the gTruth input. The returned objects contain only the labels with names specified by the labelNames input.

Limitations

- Selecting pixel labels by name is not supported. However, you can select all labels of type pixel. Use the selectLabelsByType function, specifying the label type as a labelType.PixelLabel enumeration.
- Selecting sublabels by name is not supported.

See Also

Objects

groundTruth

Functions

selectLabelsByGroup | selectLabelsByType

Introduced in R2019a

correct

Package: vision

Correction of measurement, state, and state estimation error covariance

Syntax

```
[z_corr,x_corr,P_corr] = correct(kalmanFilter,z)
```

Description

`[z_corr,x_corr,P_corr] = correct(kalmanFilter,z)` returns the correction of measurement, state, and state estimation error covariance. The correction is based on the current measurement *z*. The object overwrites the internal state and covariance of the Kalman filter with corrected values.

Examples

Tracking Objects

Use the `predict` and `correct` functions based on detection results.

When the tracked object is detected, use the `predict` and `correct` functions with the Kalman filter object and the detection measurement. Call the functions in the following order:

```
[...] = predict(kalmanFilter);  
[...] = correct(kalmanFilter,measurement);
```

When the tracked object is not detected, call the `predict` function, but not the `correct` method. When the tracked object is missing or occluded, no measurement is available. Set the functions up with the following logic:

```
[...] = predict(kalmanFilter);  
If measurement exists  
    [...] = correct(kalmanFilter,measurement);  
end
```

If the tracked object becomes available after missing for the past *t-1* contiguous time steps, you can call the `predict` function *t* times. This syntax is particularly useful to process asynchronous video.. For example,

```
for i = 1:k  
    [...] = predict(kalmanFilter);  
end  
[...] = correct(kalmanFilter,measurement)
```

Input Arguments

kalmanFilter — Kalman filter object
object

Kalman filter object.

z — Current measurement

N-element vector

Current measurement, specified as an *N*-element vector.

See Also

`configureKalmanFilter` | `assignDetectionsToTracks`

Introduced in R2012b

distance

Package: vision

Confidence value of measurement

Syntax

```
d = distance(kalmanFilter,zmatrix)
```

Description

`d = distance(kalmanFilter,zmatrix)` computes a distance between the location of a detected object and the predicted location by the Kalman filter object. This distance computation takes into account the covariance of the predicted state and the process noise. The `distance` function can only be called after the `predict` function.

Use the `distance` function to find the best matches. The computed distance values describe how a set of measurements matches the Kalman filter. You can thus select a measurement that best fits the filter. This strategy can be used for matching object detections against object tracks in a multiobject tracking problem. This distance computation takes into account the covariance of the predicted state and the process noise.

Examples

Track Location of An Object

Track the location of a physical object moving in one direction.

Generate synthetic data which mimics the 1-D location of a physical object moving at a constant speed.

```
detectedLocations = num2cell(2*randn(1,40) + (1:40));
```

Simulate missing detections by setting some elements to empty.

```
detectedLocations{1} = [];  
for idx = 16: 25  
    detectedLocations{idx} = [];  
end
```

Create a figure to show the location of detections and the results of using the Kalman filter for tracking.

```
figure;  
hold on;  
ylabel('Location');  
ylim([0,50]);  
xlabel('Time');  
xlim([0,length(detectedLocations)]);
```

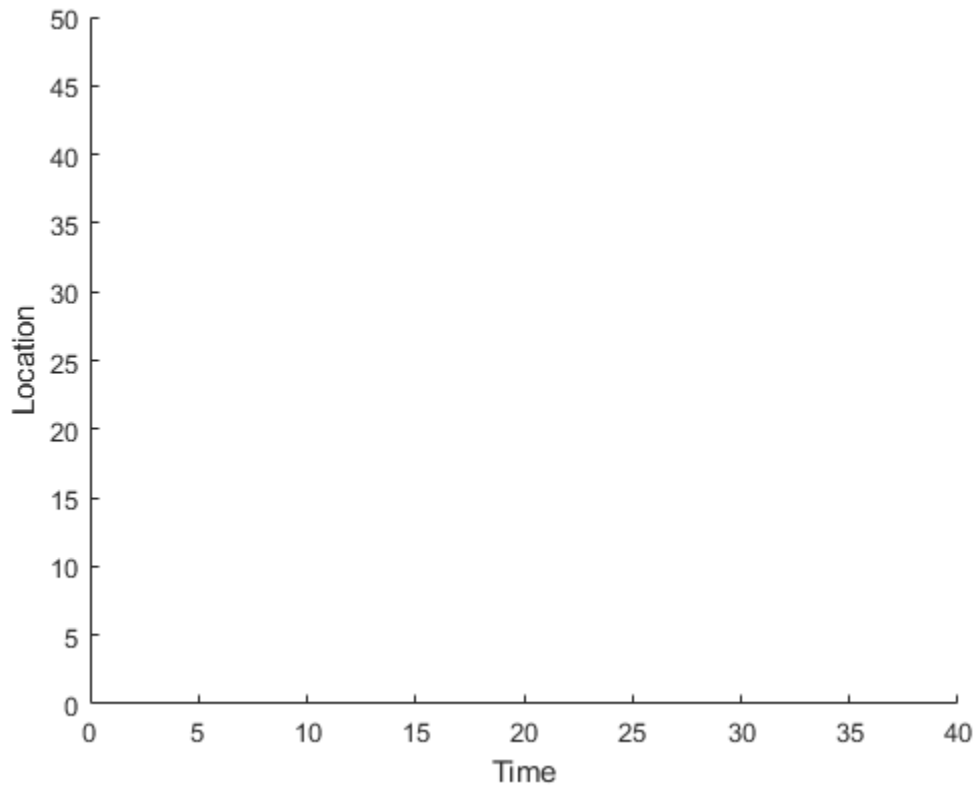
Create a 1-D, constant speed Kalman filter when the physical object is first detected. Predict the location of the object based on previous states. If the object is detected at the current time step, use its location to correct the states.

```

kalman = [];
for idx = 1: length(detectedLocations)
    location = detectedLocations{idx};
    if isempty(kalman)
        if ~isempty(location)

            stateModel = [1 1;0 1];
            measurementModel = [1 0];
            kalman = vision.KalmanFilter(stateModel,measurementModel,'ProcessNoise',1e-4,'MeasurementNoise',1e-4);
            kalman.State = [location, 0];
        end
    else
        trackedLocation = predict(kalman);
        if ~isempty(location)
            plot(idx, location,'k+');
            d = distance(kalman,location);
            title(sprintf('Distance:%f', d));
            trackedLocation = correct(kalman,location);
        else
            title('Missing detection');
        end
        pause(0.2);
        plot(idx,trackedLocation,'ro');
    end
end

```

```

end
end
legend('Detected locations','Predicted/corrected locations');

```

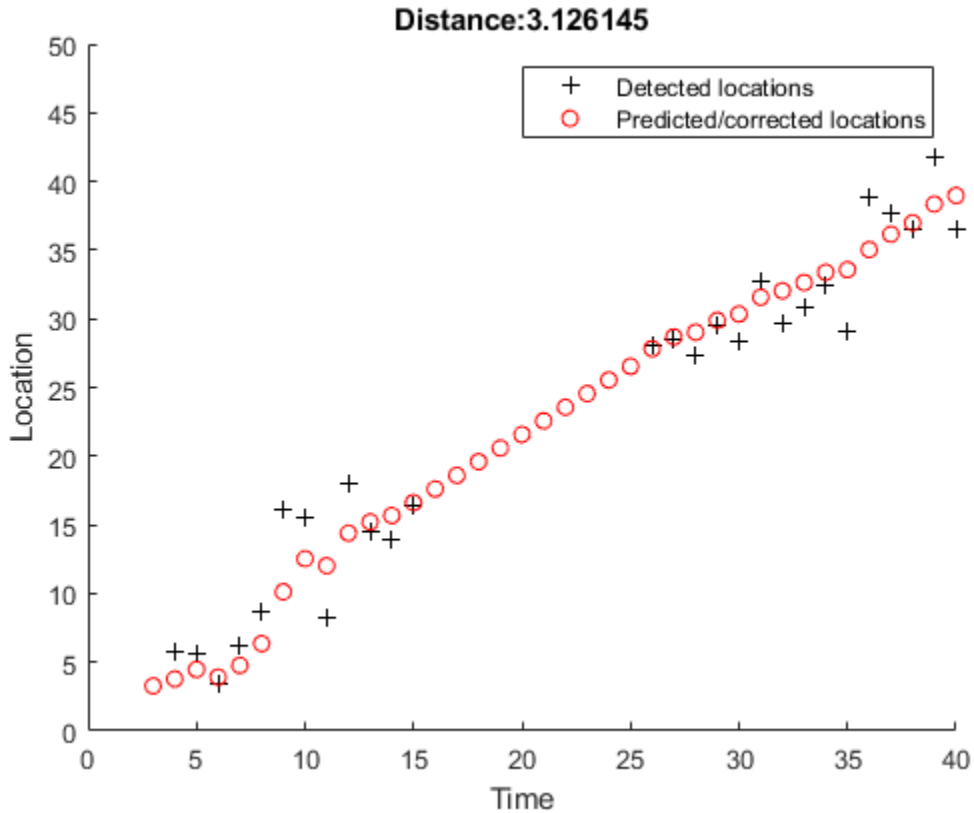

Remove Noise From a Signal

Use Kalman filter to remove noise from a random signal corrupted by a zero-mean Gaussian noise.

Synthesize a random signal that has value of 1 and is corrupted by a zero-mean Gaussian noise with standard deviation of 0.1.

```

x = 1;
len = 100;
z = x + 0.1 * randn(1,len);

```

Remove noise from the signal by using a Kalman filter. The state is expected to be constant, and the measurement is the same as state.

```

stateTransitionModel = 1;
measurementModel = 1;
obj = vision.KalmanFilter(stateTransitionModel,measurementModel,'StateCovariance',1,'ProcessNoise');

z_corr = zeros(1,len);
for idx = 1: len
    predict(obj);

```

```

z_corr(idx) = correct(obj,z(idx));
end

```

Plot results.

```

figure, plot(x * ones(1,len),'g-');
hold on;
plot(1:len,z,'b+',1:len,z_corr,'r-');
legend('Original signal','Noisy signal','Filtered signal');

```

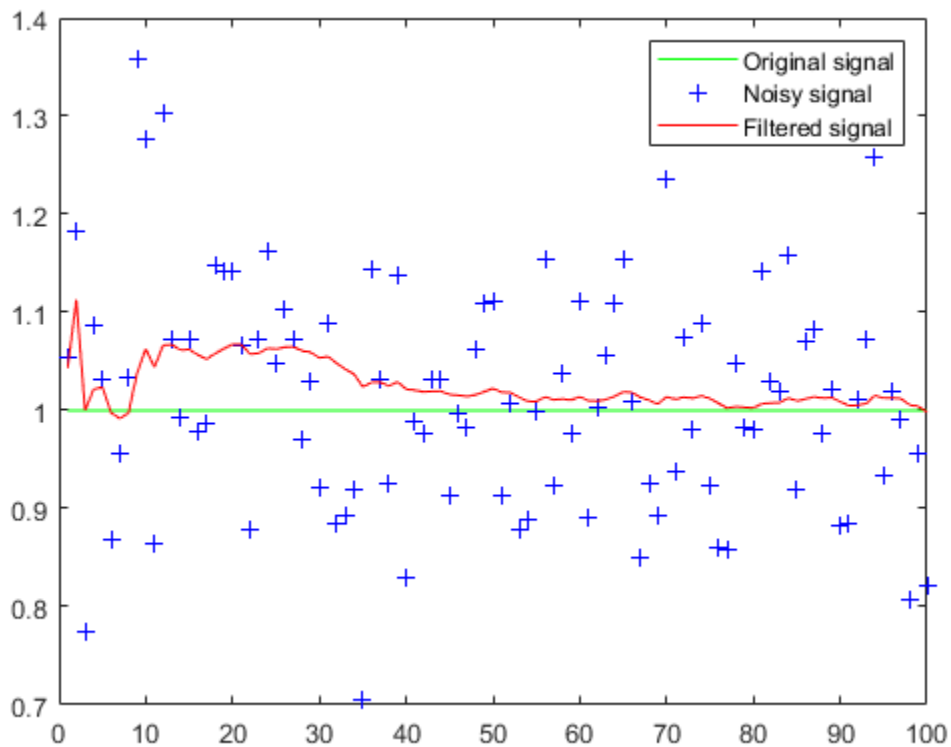

Input Arguments

kalmanFilter – Kalman filter object

object

Kalman filter object.

zmatrix – Location of a detected object

N -column matrix

Location of a detected object, specified as an N -column matrix. Each row matrix contains a measurement vector. The distance function returns a row vector where each distance element corresponds to the measurement input.

More About

Distance Equation

$$d(z) = (z - Hx)^T \Sigma^{-1} (z - Hx) + \ln|\Sigma|$$

Where $\Sigma = HPH^T + R$ and $|\Sigma|$ is the determinant of Σ . You can then find the best matches by examining the returned distance values.

See Also

`configureKalmanFilter` | `assignDetectionsToTracks`

Introduced in R2012b

vision.KalmanFilter.predict

Package: vision

Prediction of measurement

Syntax

```
[z_pred,x_pred,P_pred] = predict(kalmanFilter)
[z_pred,x_pred,P_pred] = predict(kalmanFilter,u)
```

Description

`[z_pred,x_pred,P_pred] = predict(kalmanFilter)` returns the prediction of measurement, state, and state estimation error covariance at the next time step (e.g., the next video frame). The object overwrites the internal state and covariance of the Kalman filter with the prediction results.

`[z_pred,x_pred,P_pred] = predict(kalmanFilter,u)` additionally lets you specify the control input, *u*. This syntax applies when you set the control model, *B*.

Examples

Tracking Objects

Use the `predict` and `correct` functions based on detection results.

When the tracked object is detected, use the `predict` and `correct` functions with the Kalman filter object and the detection measurement. Call the functions in the following order:

```
[...] = predict(kalmanFilter);
[...] = correct(kalmanFilter,measurement);
```

When the tracked object is not detected, call the `predict` function, but not the `correct` method. When the tracked object is missing or occluded, no measurement is available. Set the functions up with the following logic:

```
[...] = predict(kalmanFilter);
If measurement exists
    [...] = correct(kalmanFilter,measurement);
end
```

If the tracked object becomes available after missing for the past *t-1* contiguous time steps, you can call the `predict` function *t* times. This syntax is particularly useful to process asynchronous video.. For example,

```
for i = 1:k
    [...] = predict(kalmanFilter);
```

```
end  
[...] = correct(kalmanFilter,measurement)
```

Input Arguments

kalmanFilter — Kalman filter object

object

Kalman filter object.

u — Control input

L -element vector

Control input, specified as an L -element vector.

See Also

`configureKalmanFilter` | `assignDetectionsToTracks`

Introduced in R2012b

pregistercpd

Register two point clouds using CPD algorithm

Syntax

```
tform = pregistercpd(moving, fixed)
[tform, movingReg] = pregistercpd(moving, fixed)
[ ___, rmse] = pregistercpd(moving, fixed)
[ ___ ] = pregistercpd(moving, fixed, Name, Value)
```

Description

`tform = pregistercpd(moving, fixed)` returns a transformation that registers a moving point cloud with a fixed point cloud using the coherent point drift (CPD) algorithm [1].

Note Consider downsampling point clouds using `pcdsample` before using `pregistercpd` to improve the efficiency of registration.

`[tform, movingReg] = pregistercpd(moving, fixed)` also returns the transformed point cloud that aligns with the fixed point cloud.

`[___, rmse] = pregistercpd(moving, fixed)` also returns the root mean square error of the Euclidean distance between the aligned point clouds, using any of the preceding syntaxes.

`[___] = pregistercpd(moving, fixed, Name, Value)` uses additional options specified by one or more `Name, Value` pair arguments.

Examples

Align Two Point Clouds Using CPD Algorithm

Load point cloud data into the workspace. Extract the moving and the fixed point clouds from the point cloud data in workspace.

```
handData = load('hand3d.mat');
moving = handData.moving;
fixed = handData.fixed;
```

To improve the efficiency and accuracy of the CPD registration algorithm, downsample the moving and the fixed point clouds.

```
movingDownsampled = pcdsample(moving, 'gridAverage', 0.03);
fixedDownsampled = pcdsample(fixed, 'gridAverage', 0.03);
```

Display the downsampled point clouds before registration.

```
figure
pcshowpair(movingDownsampled, fixedDownsampled, 'MarkerSize', 50)
```

```

xlabel('X')
ylabel('Y')
zlabel('Z')
title('Point clouds before registration')
legend({'Moving point cloud','Fixed point cloud'},'TextColor','w')
legend('Location','southoutside')

```

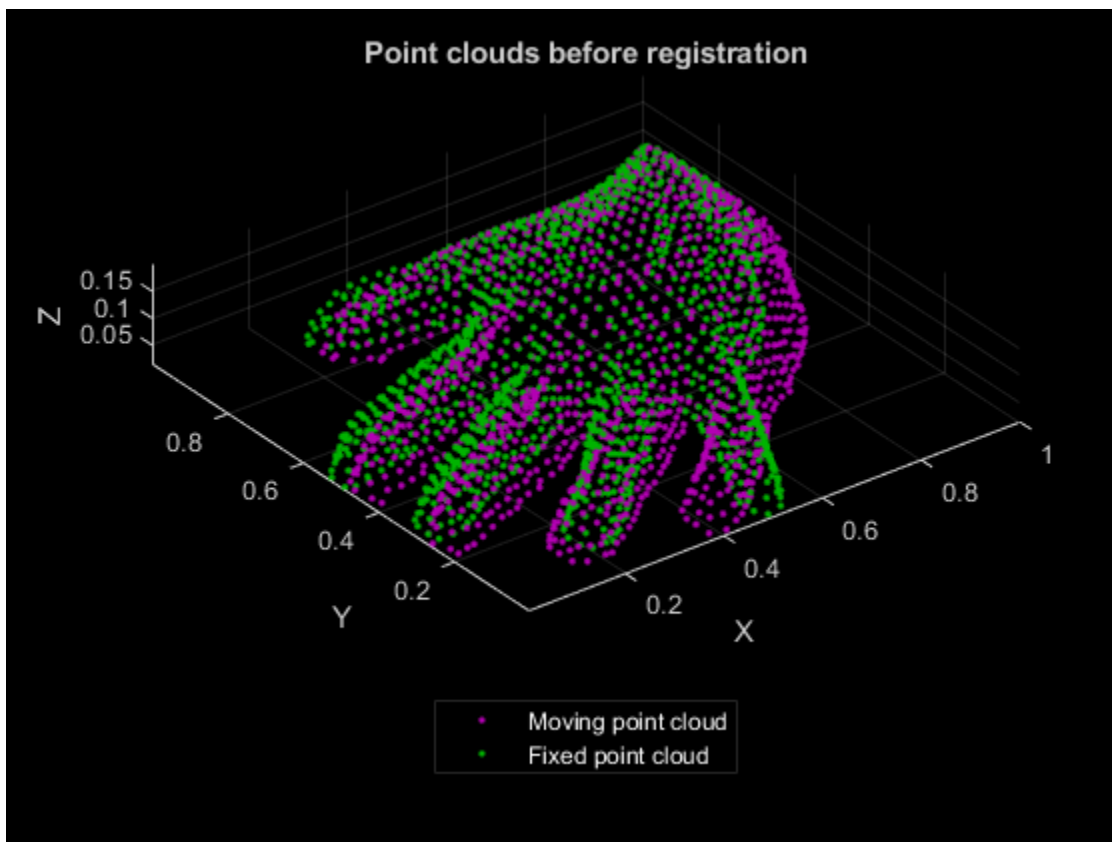

Perform non-rigid registration using the CPD algorithm.

```

tform = pcregistercpd(movingDownsampled,fixedDownsampled);
movingReg = pctransform(movingDownsampled,tform);

```

Display the downsampled point clouds after registration.

```

figure
pcshowpair(movingReg,fixedDownsampled,'MarkerSize',50)
xlabel('X')
ylabel('Y')
zlabel('Z')
title('Point clouds after registration')
legend({'Moving point cloud','Fixed point cloud'},'TextColor','w')
legend('Location','southoutside')

```

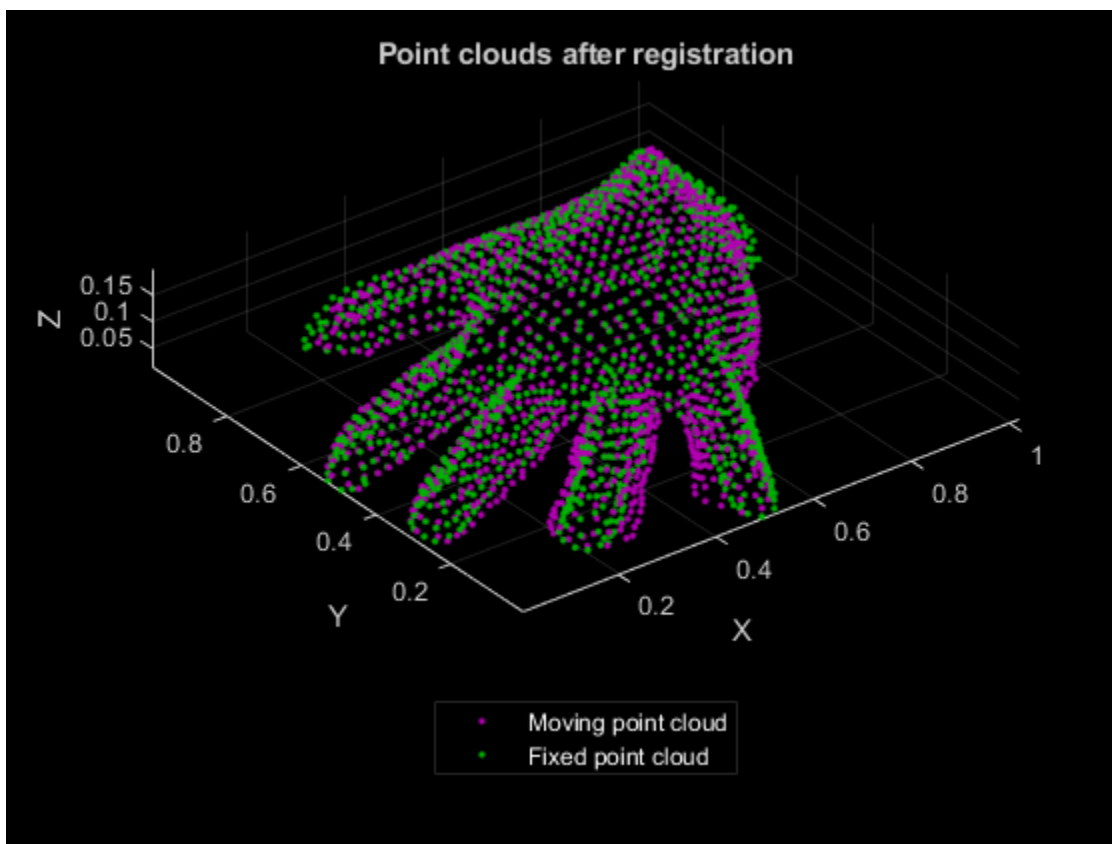
Input Arguments

moving — Moving point cloud

`pointCloud` object

Moving point cloud, specified as a `pointCloud` object.

fixed — Fixed point cloud

`pointCloud` object

Fixed point cloud, specified as a `pointCloud` object.

Name-Value Pair Arguments

Specify optional comma-separated pairs of `Name`, `Value` arguments. `Name` is the argument name and `Value` is the corresponding value. `Name` must appear inside quotes. You can specify several name and value pair arguments in any order as `Name1, Value1, ..., NameN, ValueN`.

Example: `'MaxIterations', 20` stops the CPD algorithm after 20 iterations.

Transform — Type of transformation

`'Nonrigid'` (default) | `'Rigid'` | `'Affine'`

Type of transformation, specified as the comma-separated pair consisting of `'Transform'` and the `'Nonrigid'`, `'Rigid'`, or `'Affine'` character vectors or string scalars.

Data Types: char | string

OutlierRatio — Expected percentage of outliers

0.1 (default) | scalar in the range [0, 1)

Expected percentage of outliers with respect to a normal distribution, specified as the comma-separated pair consisting of 'OutlierRatio' and a scalar in the range [0, 1). Increasing this value reduces the influence of outliers and noise.

Data Types: single | double

MaxIterations — Maximum number of iterations

20 (default) | positive integer

Maximum number of iterations before CPD stops, specified as the comma-separated pair consisting of 'MaxIterations' and a positive integer.

Data Types: single | double

Tolerance — Tolerance between consecutive CPD iterations

1e-5 (default) | scalar

Tolerance between consecutive CPD iterations, specified as the comma-separated pair consisting of 'Tolerance' and a scalar. The algorithm stops when absolute percentage change in the values of the log likelihood function measured between consecutive iterations reaches or falls below the specified tolerance value. Decreasing this value increases the likelihood of a better alignment.

Data Types: single | double

InteractionSigma — Interaction between points

2.0 (default) | positive scalar

Interaction between points, specified as the comma-separated pair consisting of 'InteractionSigma' and a positive scalar that represents standard deviation of a Gaussian filter. Typical values are in the range [1.5,3]. Increasing this value increases interaction between the points in point cloud. As a result, you can observe coherent motion in the point cloud and every point undergoes the same displacement. Alternatively, decreasing this value reduces interaction between the points in point cloud. As a result, you can observe localized displacement of points and the output displacement field exhibits localized deformation.

Note To use this name-value pair, 'Transform' must be 'Nonrigid'.

Data Types: single | double

SmoothingWeight — Motion smoothing weight

3.0 (default) | positive scalar

Motion smoothing weight, specified as the comma-separated pair consisting of 'SmoothingWeight' and a positive scalar. Typical values are in the range [0.1,10]. Increase this value to produce a more coherent motion in the output displacement field.

Note To use this name-value pair, 'Transform' must be 'Nonrigid'.

Data Types: `single` | `double`

Verbose — Display progress information

`false` (default) | `true`

Display progress information, specified as the comma-separated pair consisting of 'Verbose' and a logical scalar. Set 'Verbose' to `true` to display progress information.

Data Types: `logical`

Note Both 'MaxIterations' and 'Tolerance' are used as stopping criteria. The algorithm stops when it satisfies either of the stopping conditions, i.e., when the number of iteration reaches `MaxIterations` or the absolute percentage change in log likelihood function is less than or equal to `Tolerance`.

Output Arguments

tform — Transformation

`rigid3d` object | `affine3d` object | displacement field

Transformation, returned as a `rigid3d`, `affine3d` object, or a displacement field. `tform` is a 3-D transformation that registers the moving point cloud, `moving` to the fixed point cloud, `fixed`. The output type depends on the value of the `Transform` property.

Transform Property Value	tform
'Rigid'	<code>rigid3d</code> object
'Affine'	<code>affine3d</code> object
'Nonrigid'	Displacement field, a numeric matrix of same size and datatype as the <code>Location</code> property of the moving point cloud object, <code>moving</code> .

movingReg — Transformed point cloud

`pointCloud` object

Transformed point cloud, returned as a `pointCloud` object. The transformed point cloud is aligned with the fixed point cloud, `fixed`.

rmse — Root mean square error

positive real number

Root mean square error, returned as a positive real number. `rmse` is the Euclidean distance between the aligned point clouds.

Data Types: `double`

Algorithms

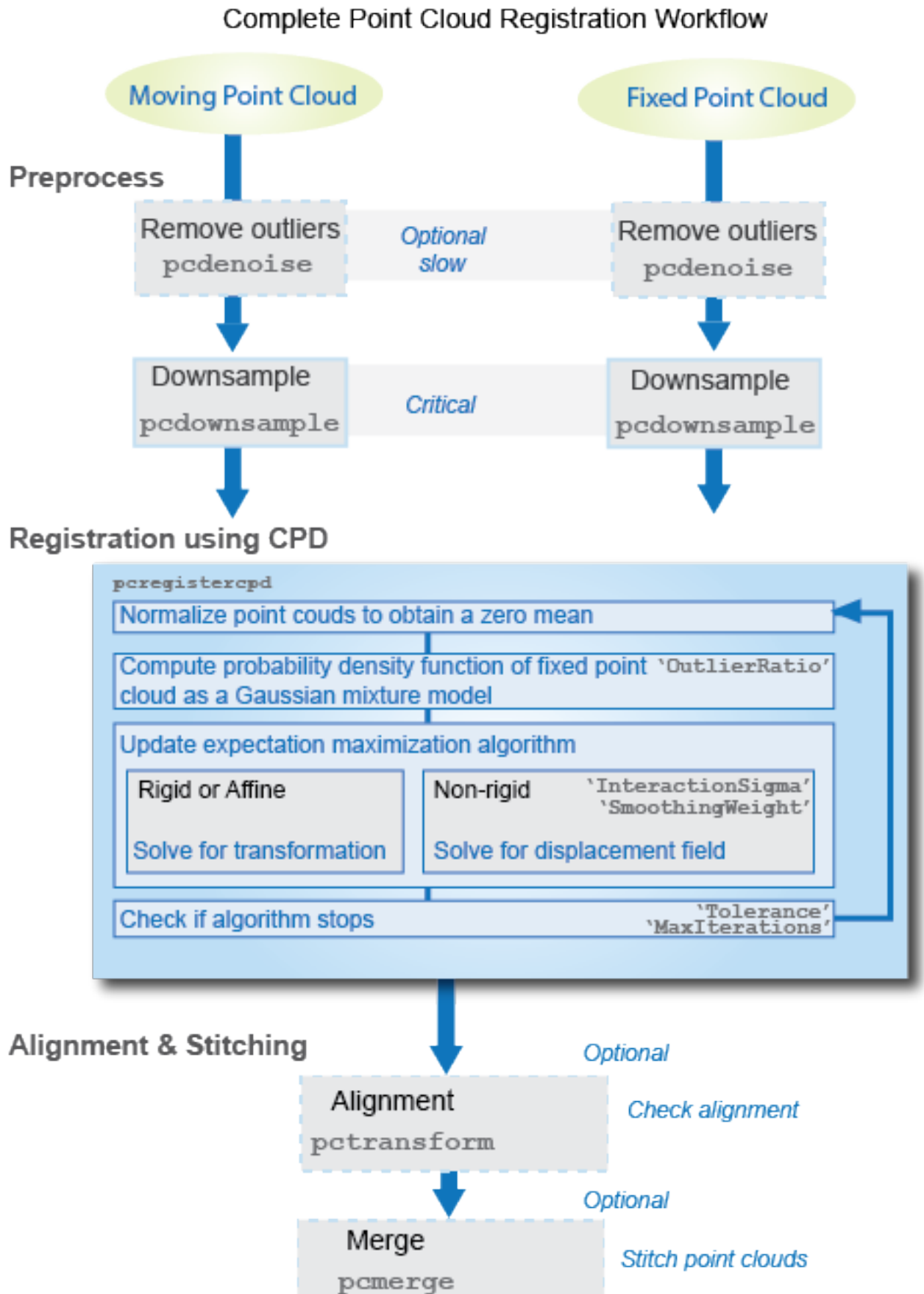

References

- [1] Myronenko, A., and X. Song. "Point Set Registration: Coherent Point Drift." *Proceedings of IEEE Transactions on Pattern Analysis and Machine Intelligence (TPAMI)*. Vol 32, Number 12, December 2010, pp. 2262–2275.

Extended Capabilities

C/C++ Code Generation

Generate C and C++ code using MATLAB® Coder™.

- The name-value pair argument 'Transform' must be compile-time constant.

See Also

Functions

pregistercorr | pregistericp | pregisterndt | pctransform | pcshow | pcshowpair | pcdsample | pcfplane | pcdnoise | pcmerge

Objects

pointCloud | affine3d | rigid3d

Topics

"3-D Point Cloud Registration and Stitching"
"Implement Point Cloud SLAM in MATLAB"

Introduced in R2018b

initializeObject

System object: vision.HistogramBasedTracker

Package: vision

Set object to track

Syntax

```
initializeObject(hbtracker,I,R)
initializeObject(hbtracker,I,R,N)
```

Description

`initializeObject(hbtracker,I,R)` sets the object to track by extracting it from the [x y width height] region R located in the 2-D input image, I. The input image, I, can be any 2-D feature map that distinguishes the object from the background. For example, the image can be a hue channel of the HSV color space. Typically, I will be the first frame in which the object appears. The region, R, is also used for the initial search window, in the next call to the `step` method. For best results, the object must occupy the majority of the region, R.

`initializeObject(hbtracker,I,R,N)` additionally, lets you specify N, the number of histogram bins.

Examples

Track a Face

Track and display a face in each frame of an input video.

Create System objects for reading and displaying video and for drawing a bounding box of the object.

```
videoReader = VideoReader('vipcolorsegmentation.avi');
videoPlayer = vision.VideoPlayer();
shapeInserter = vision.ShapeInserter('BorderColor','Custom', ...
    'CustomBorderColor',[1 0 0]);
```

Read the first video frame, which contains the object. Convert the image to HSV color space. Then define and display the object region.

```
objectFrame = im2single(readFrame(videoReader));
objectHSV = rgb2hsv(objectFrame);
objectRegion = [40, 45, 25, 25];
objectImage = shapeInserter(objectFrame, objectRegion);
```

```
figure
imshow(objectImage)
title('Red box shows object region')
```

Red box shows object region

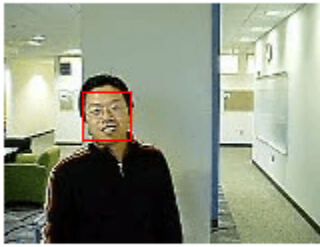

(Optionally, you can select the object region using your mouse. The object must occupy the majority of the region. Use the following command.)

```
figure; imshow(objectFrame); objectRegion=round(getPosition(imrect))
```

Set the object, based on the hue channel of the first video frame.

```
tracker = vision.HistogramBasedTracker;
initializeObject(tracker, objectHSV(:,:,1) , objectRegion);
```

Track and display the object in each video frame. The while loop reads each image frame, converts the image to HSV color space, then tracks the object in the hue channel where it is distinct from the background. Finally, the example draws a box around the object and displays the results.

```
while hasFrame(videoReader)
    frame = im2single(readFrame(videoReader));
    hsv = rgb2hsv(frame);
    bbox = tracker(hsv(:,:,1));

    out = shapeInserter(frame,bbox);
    videoPlayer(out);
end
```

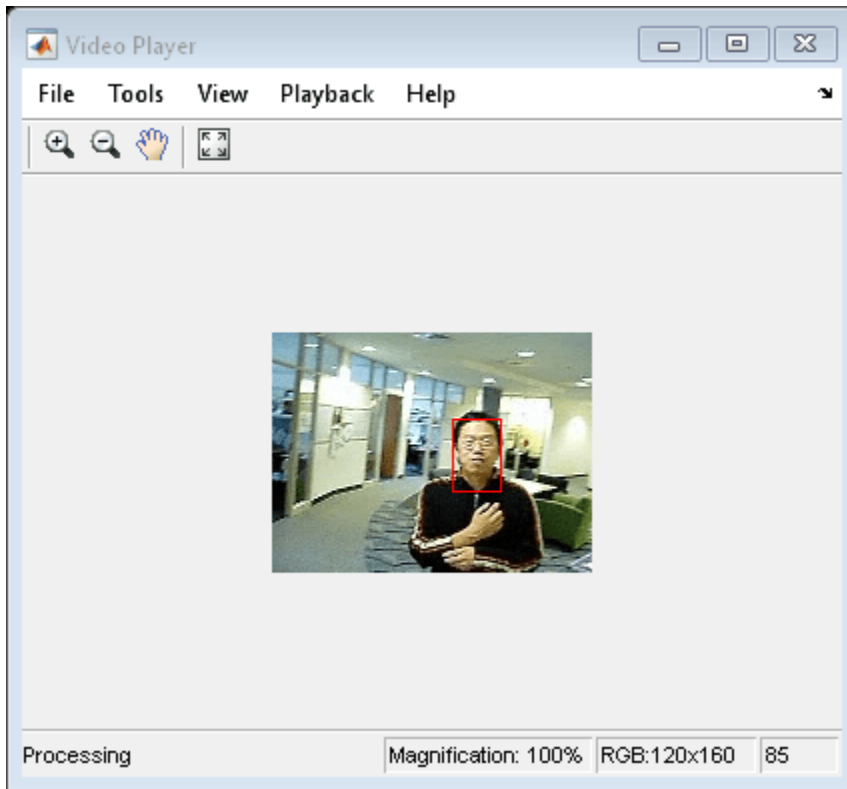

Release the video player.

```
release(videoPlayer);
```

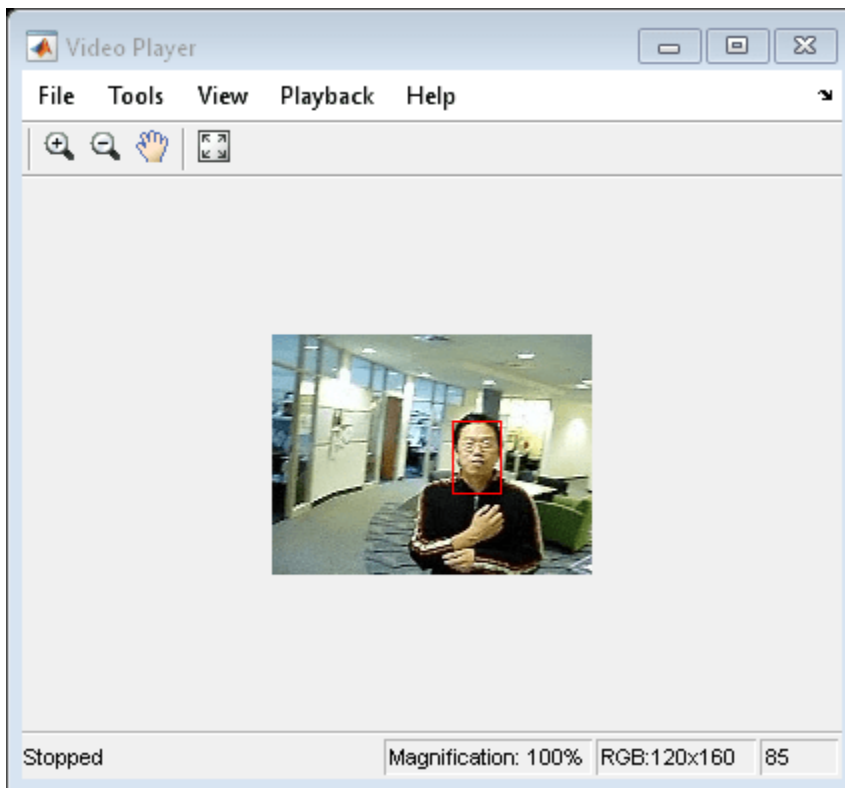
Input Arguments

hbtracker – Histogram based tracker

`vision.HistogramBasedTracker` object

Histogram based tracker, specified as a `vision.HistogramBasedTracker` object.

I – Video frame

grayscale | truecolor (RGB)

Video frame, specified as grayscale or truecolor (RGB).

R – Initial search window

`[x y width height]`

Initial search window, specified in the format `[x y width height]`.

N – Number of histogram bins

16 (default) | integer

Number of histogram bins, specified as an integer. Increasing the number of bins enhances the ability of the tracker to discriminate the object. However, this approach also narrows the range of changes to the object's visual characteristics that the tracker can accommodate. Consequently, this narrow range increases the likelihood of losing track.

Introduced in R2012a

hide

Package:

Hide player figure

Syntax

```
hide(player)
```

Description

`hide(player)` hides the figure. To redisplay the player, use `show` on page 3-191(`player`).

Examples

Hide and Show 3-D Point Cloud Figure

Load point cloud.

```
ptCloud = pcread('teapot.ply');
```

Create the player and customize player axis labels.

```
player = pcplayer(ptCloud.XLimits,ptCloud.YLimits,ptCloud.ZLimits);
```

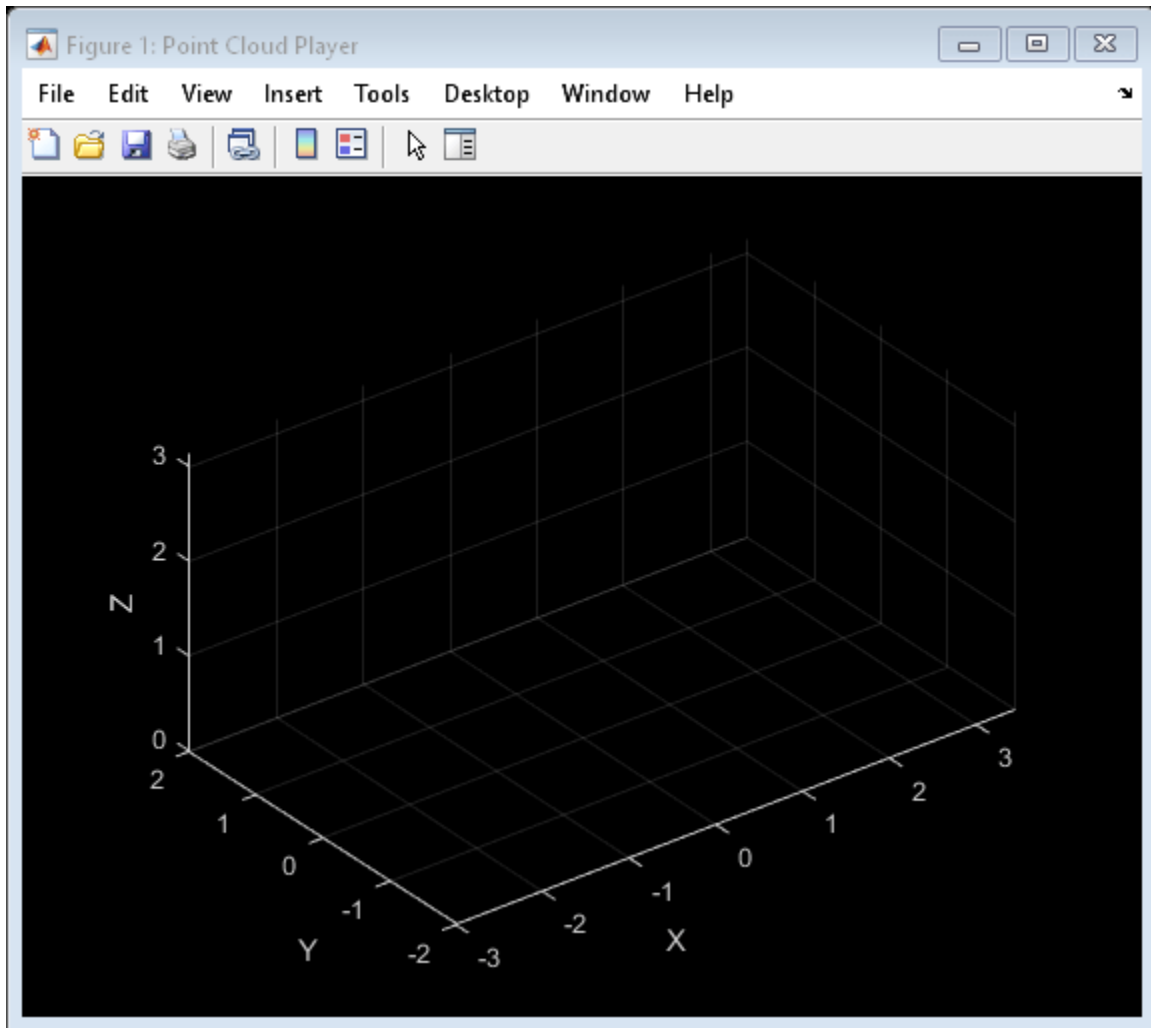

Hide figure.

```
hide(player)
```

Show figure.

```
show(player)  
view(player,ptCloud);
```

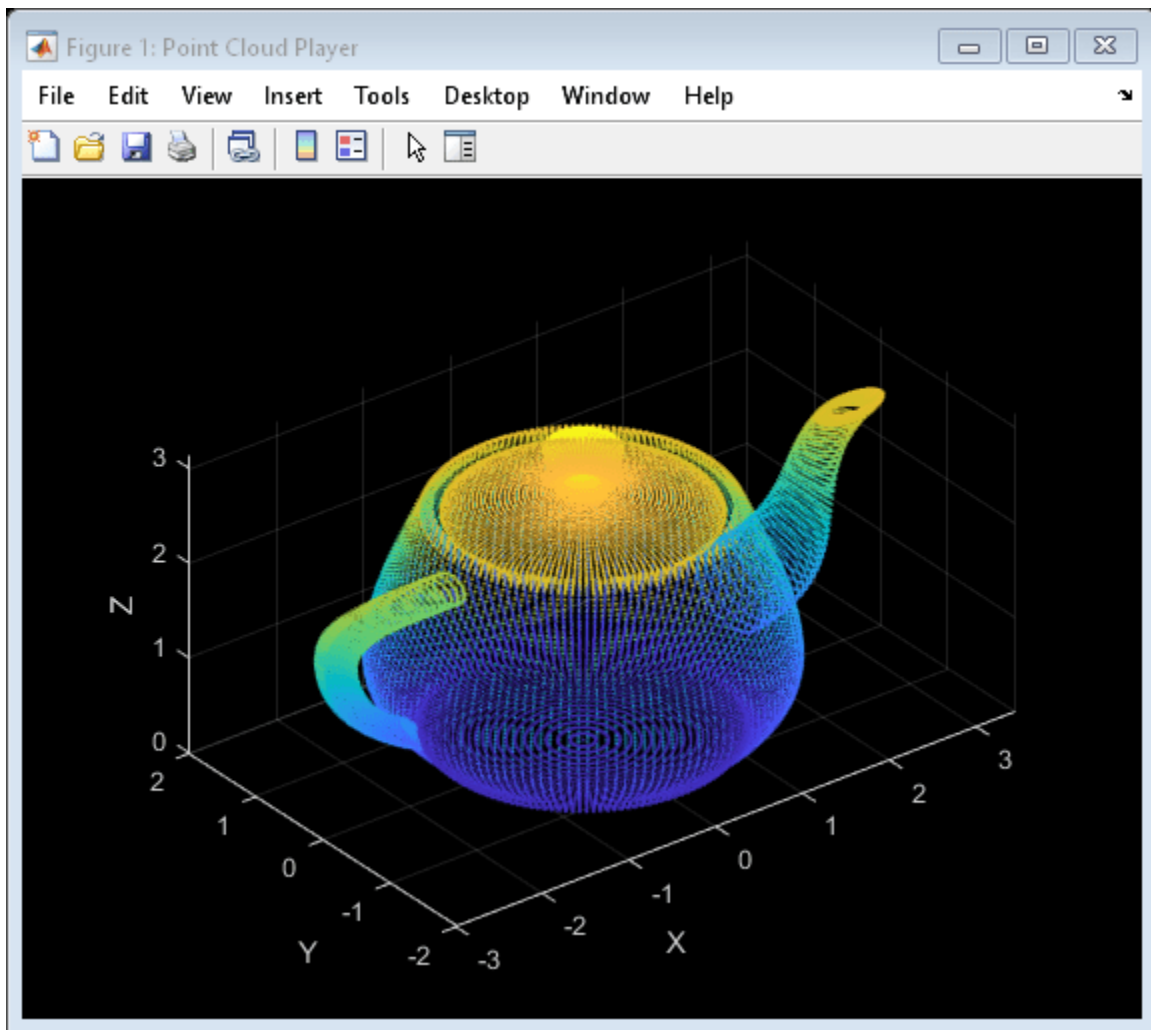

Input Arguments

player — Player

player object

Player for data, specified as a `pcplayer` or `vision.VideoPlayer` object.

Introduced in R2015b

show

Package:

Show player

Syntax

```
show(player)
```

Description

`show(player)` makes the player figure visible again after closing or hiding it.

Examples**Hide and Show 3-D Point Cloud Figure**

Load point cloud.

```
ptCloud = pcread('teapot.ply');
```

Create the player and customize player axis labels.

```
player = pcplayer(ptCloud.XLimits,ptCloud.YLimits,ptCloud.ZLimits);
```

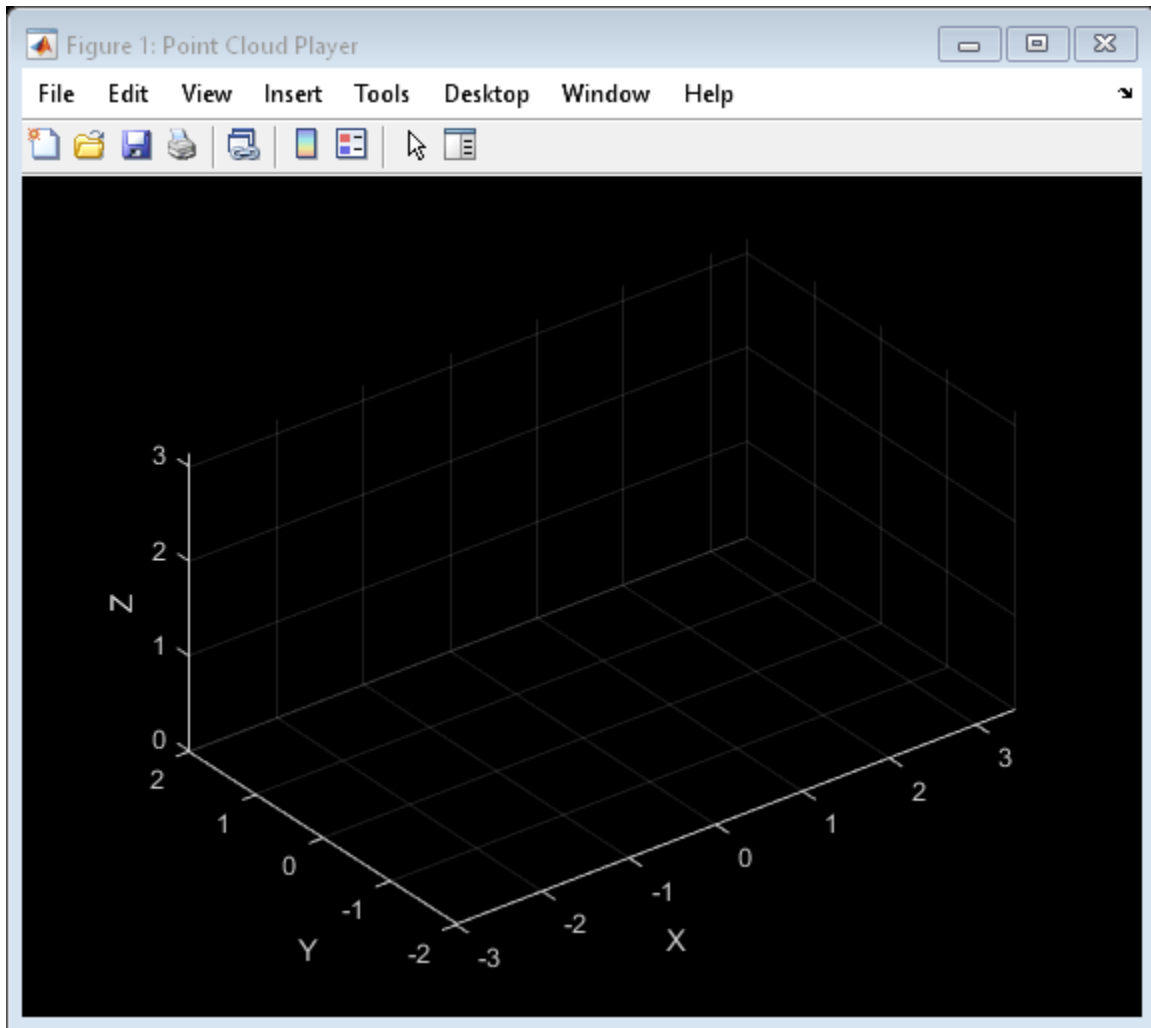

Hide figure.

```
hide(player)
```

Show figure.

```
show(player)  
view(player,ptCloud);
```

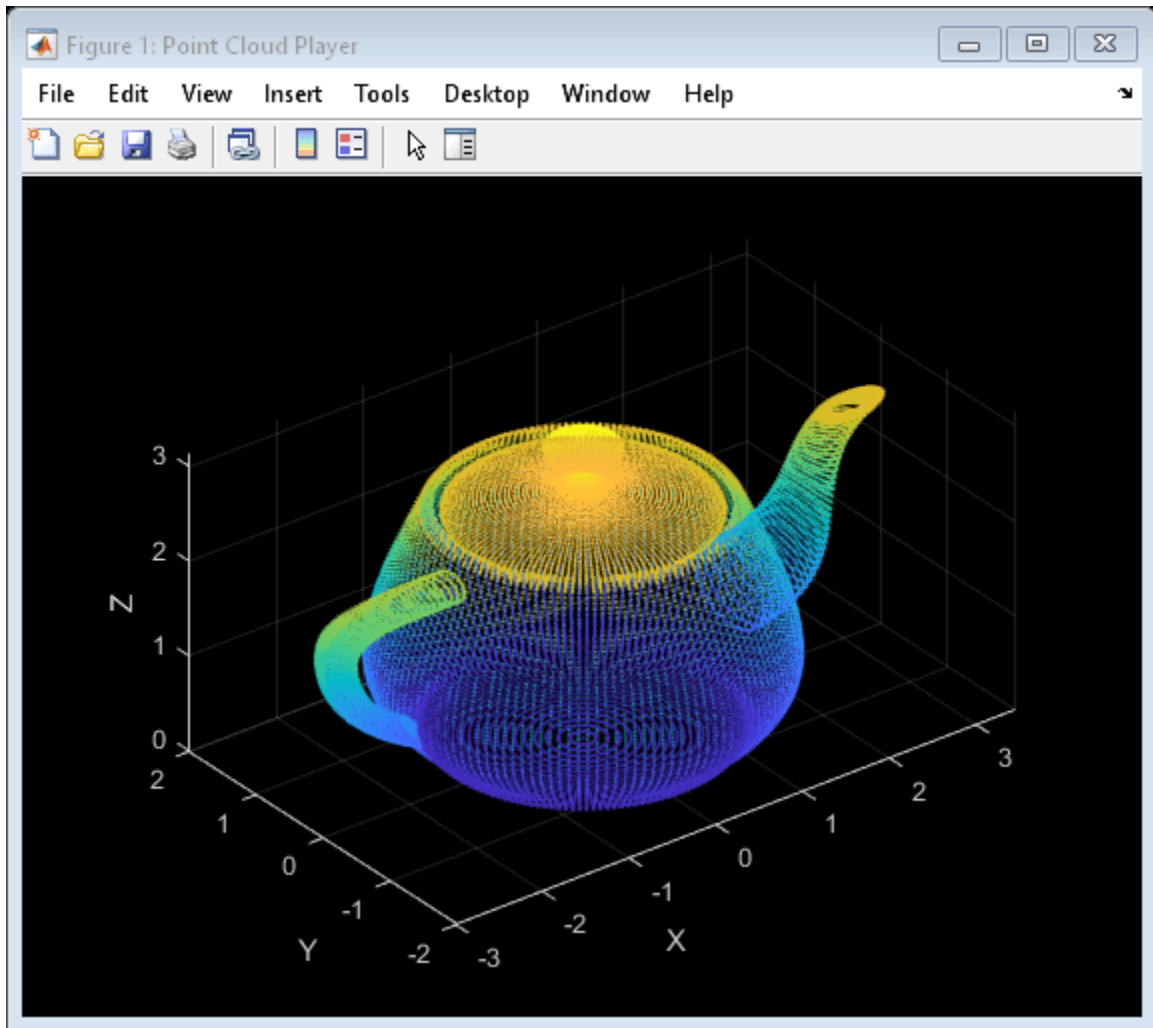

Input Arguments

player – Player

object

Player for visualizing data streams, specified as a `pcplayer` or a `vision.VideoPlayer` object. Use this method to view the figure after you have removed it from display. For example, after you `x-out` of a figure and you want to view it again. This is particularly useful to use after a while loop that contains display code ends.

Introduced in R2015b

initializeSearchWindow

Set initial search window

Syntax

```
initializeSearchWindow(hbtracker,R)
```

Description

`initializeSearchWindow(hbtracker,R)` sets the initial search window region,`R`. The tracker uses this region as the initial window to search for the object. You can also use this function when the tracker loses track of the object. Use the function to reinitialize an object's initial location and size.

Examples

Track a Face

Track and display a face in each frame of an input video.

Create System objects for reading and displaying video and for drawing a bounding box of the object.

```
videoReader = VideoReader('vipcolorsegmentation.avi');
videoPlayer = vision.VideoPlayer();
shapeInserter = vision.ShapeInserter('BorderColor','Custom', ...
    'CustomBorderColor',[1 0 0]);
```

Read the first video frame, which contains the object. Convert the image to HSV color space. Then define and display the object region.

```
objectFrame = im2single(readFrame(videoReader));
objectHSV = rgb2hsv(objectFrame);
objectRegion = [40, 45, 25, 25];
objectImage = shapeInserter(objectFrame, objectRegion);
```

```
figure
imshow(objectImage)
title('Red box shows object region')
```

Red box shows object region



(Optionally, you can select the object region using your mouse. The object must occupy the majority of the region. Use the following command.)

```
figure; imshow(objectFrame); objectRegion=round(getPosition(imrect))
```

Set the object, based on the hue channel of the first video frame.

```
tracker = vision.HistogramBasedTracker;
initializeObject(tracker, objectHSV(:,:,1) , objectRegion);
```

Track and display the object in each video frame. The while loop reads each image frame, converts the image to HSV color space, then tracks the object in the hue channel where it is distinct from the background. Finally, the example draws a box around the object and displays the results.

```
while hasFrame(videoReader)
    frame = im2single(readFrame(videoReader));
    hsv = rgb2hsv(frame);
    bbox = tracker(hsv(:,:,1));

    out = shapeInserter(frame,bbox);
    videoPlayer(out);
end
```

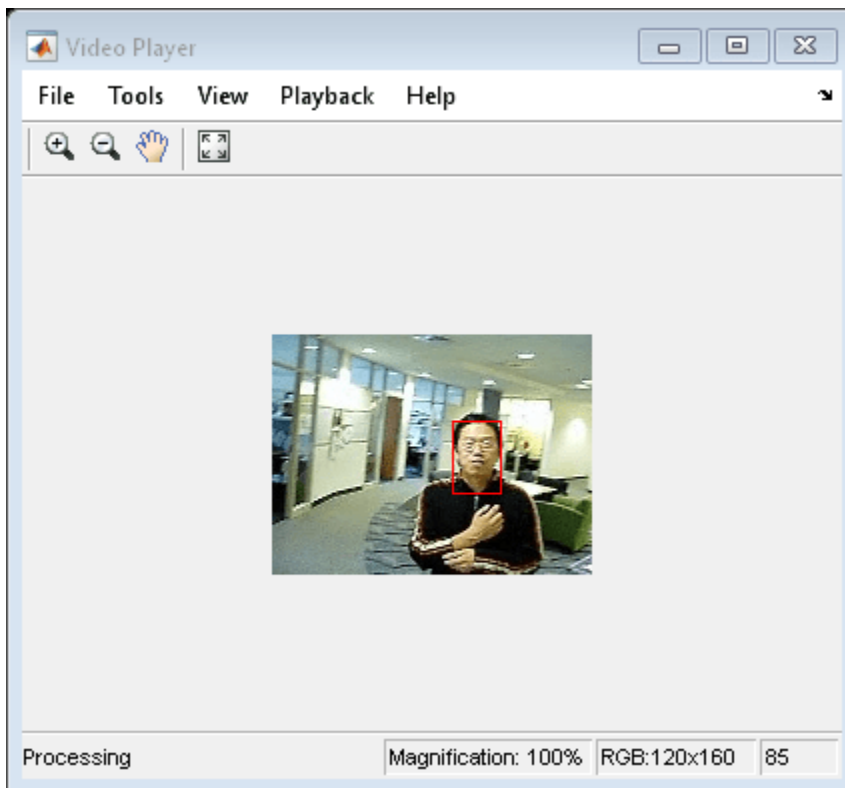

Release the video player.

```
release(videoPlayer);
```

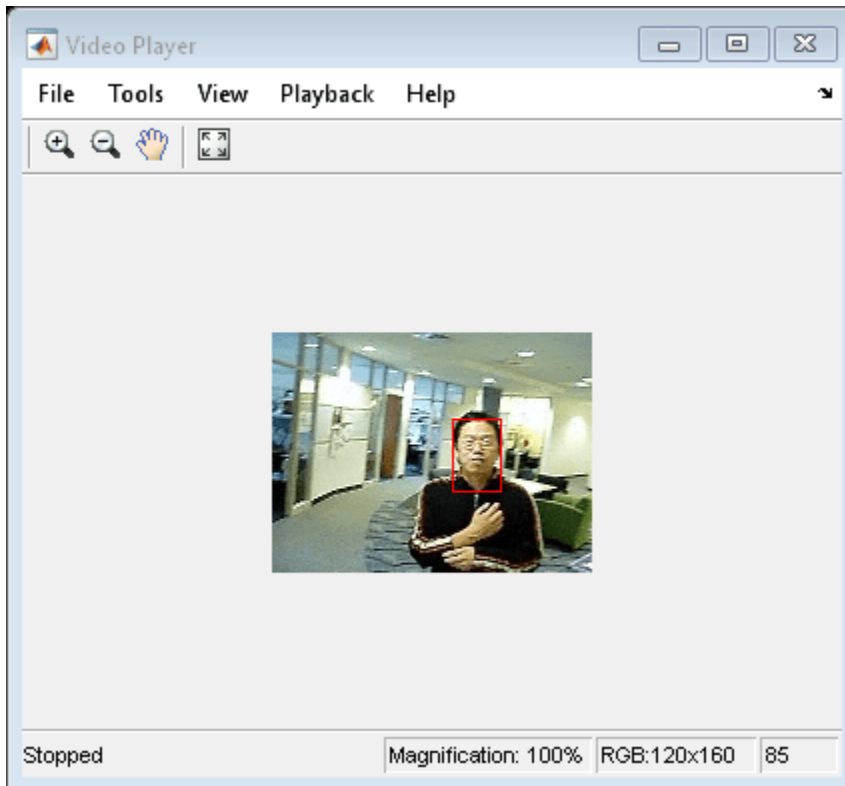

Input Arguments

hbtracker – Histogram based tracker

`vision.HistogramBasedTracker` object

Histogram based tracker, specified as a `vision.HistogramBasedTracker` object.

R – Initial search window

`[x y width height]`

Initial search window, specified in the format `[x y width height]`.

Introduced in R2012a

initialize

Initialize video frame and points to track

Syntax

```
initialize(pointTracker,points,I)
```

Description

`initialize(pointTracker,points,I)` initializes points to track and sets the initial video frame. The function sets the M -by-2 points array of [x y] coordinates with the points to track, and sets the initial video frame, I.

If you want to use the point tracker as a persistent variable, you must call `initialize` only during creation. If you call `initialize` in a loop, the previous state is lost and therefore, the tracker cannot maintain tracking.

Examples

Track a Face in Scene

Create System objects for reading and displaying video and for drawing a bounding box of the object.

```
videoReader = VideoReader('visionface.avi');
videoPlayer = vision.VideoPlayer('Position',[100,100,680,520]);
```

Read the first video frame, which contains the object, define the region.

```
objectFrame = readFrame(videoReader);
objectRegion = [264,122,93,93];
```

As an alternative, you can use the following commands to select the object region using a mouse. The object must occupy the majority of the region:

```
figure; imshow(objectFrame);
objectRegion=round(getPosition(imrect))
```

Show initial frame with a red bounding box.

```
objectImage = insertShape(objectFrame,'Rectangle',objectRegion,'Color','red');
figure;
imshow(objectImage);
title('Red box shows object region');
```

Red box shows object region



Detect interest points in the object region.

```
points = detectMinEigenFeatures(im2gray(objectFrame), 'ROI', objectRegion);
```

Display the detected points.

```
pointImage = insertMarker(objectFrame, points.Location, '+', 'Color', 'white');  
figure;  
imshow(pointImage);  
title('Detected interest points');
```

Detected interest points



Create a tracker object.

```
tracker = vision.PointTracker('MaxBidirectionalError',1);
```

Initialize the tracker.

```
initialize(tracker,points.Location,objectFrame);
```

Read, track, display points, and results in each video frame.

```
while hasFrame(videoReader)
    frame = readFrame(videoReader);
    [points,validity] = tracker(frame);
    out = insertMarker(frame,points(validity, :),'+');
    videoPlayer(out);
end
```

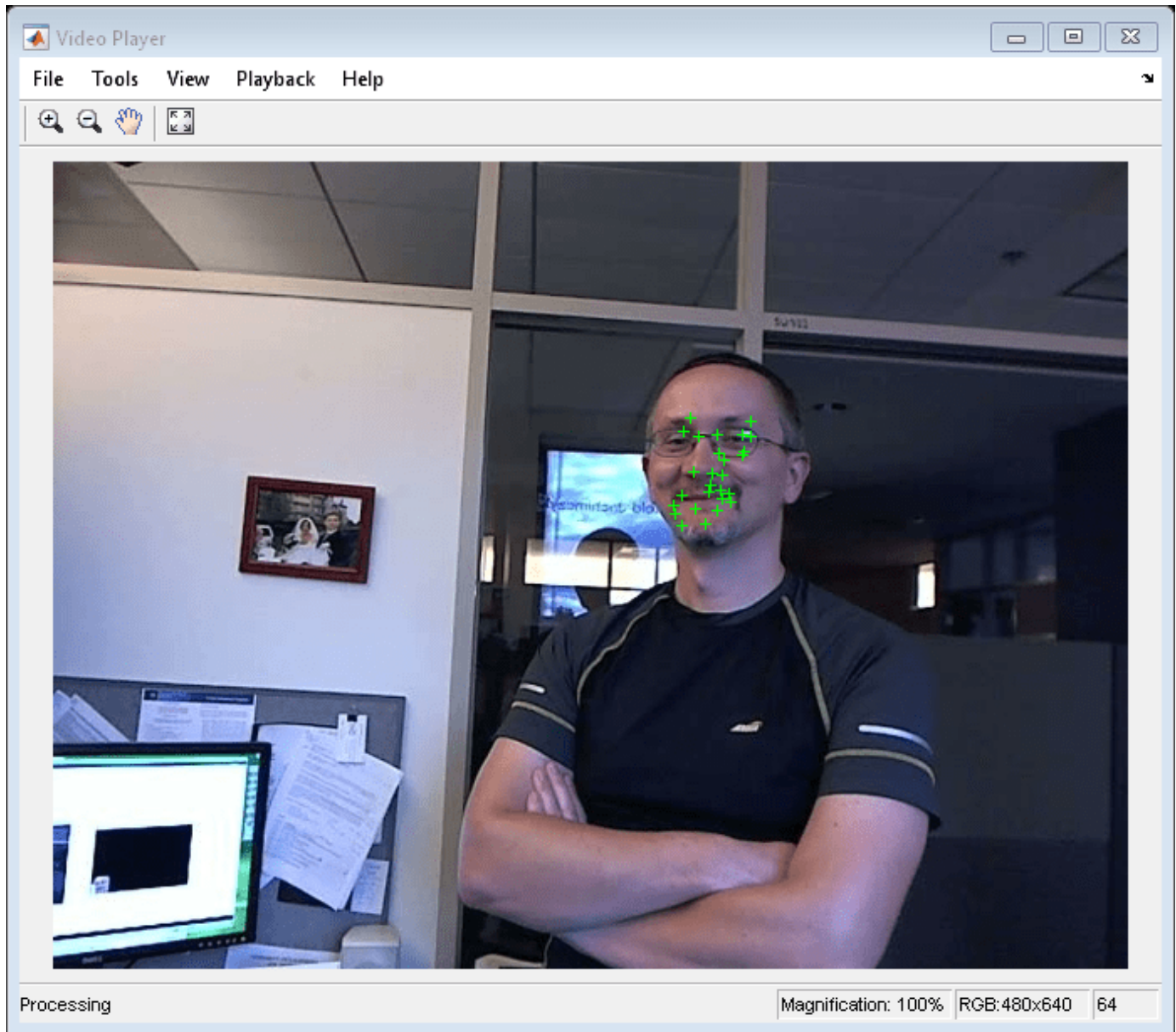

Release the video player.

```
release(videoPlayer);
```

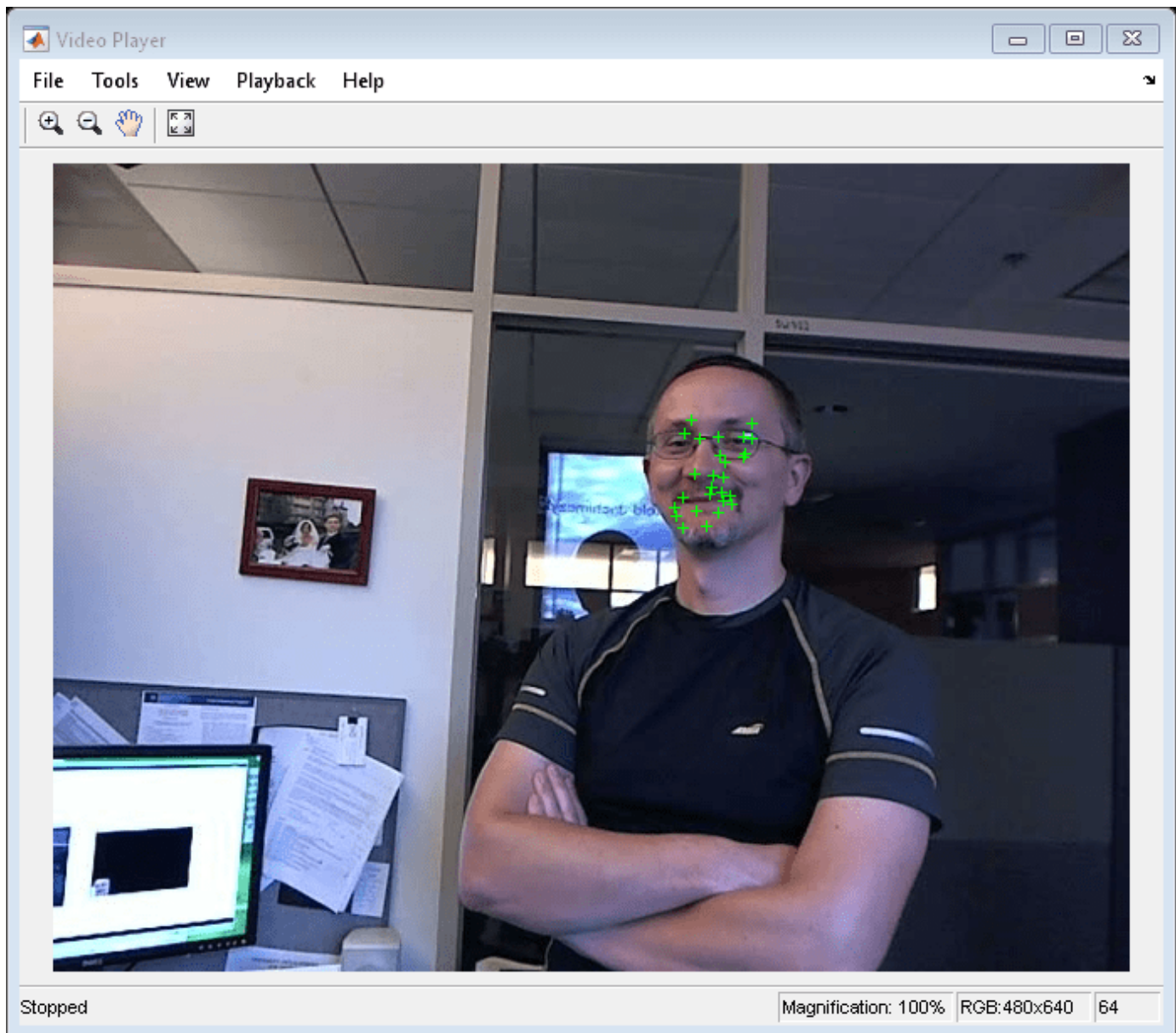
Input Arguments

pointTracker – Point tracker

PointTracker object

Point tracker, specified as a `vision.PointTracker` object.

points – Points

M -by-2 array

Points, specified as an M -by-2 array of $[x\ y]$ coordinates that correspond to the locations of the points in the input frame, `I`.

I – Video frame

grayscale | truecolor (RGB)

Video frame, specified as grayscale or truecolor (RGB) and must be the same size as the images read into the tracker.

Introduced in R2012b

fcnLayers

Create fully convolutional network layers for semantic segmentation

Syntax

```
lgraph = fcnLayers(imageSize,numClasses)
lgraph = fcnLayers(imageSize,numClasses,'Type',type)
```

Description

`lgraph = fcnLayers(imageSize,numClasses)` returns a fully convolutional network (FCN), configured as FCN 8s, for semantic segmentation. The FCN is preinitialized using layers and weights from the VGG-16 network.

`fcnLayers` includes a `pixelClassificationLayer` to predict the categorical label for every pixel in an input image. The pixel classification layer only supports RGB images.

This function requires the Deep Learning Toolbox *Model for VGG-16 Network* support package. If this support package is not installed, then the `vgg16` function provides a download link.

`lgraph = fcnLayers(imageSize,numClasses,'Type',type)` returns an FCN configured as a type specified by `type`.

Examples

Create Fully Convolutional Network 8s

Define the image size and number of classes, then create the network.

```
imageSize = [480 640];
numClasses = 5;
lgraph = fcnLayers(imageSize,numClasses)
```

Display the network.

```
plot(lgraph)
```

Create Fully Convolutional Network 16s

Create a FCN 16s.

```
imageSize = [480 640];
numClasses = 5;
lgraph = fcnLayers(imageSize,numClasses,'Type','16s')
```

Display the network.

```
plot(lgraph)
```

Input Arguments

imageSize — Network input image size

2-element vector

Network input image size, specified as a 2-element vector in the format $[height, width]$. The minimum image size is $[224\ 224]$ because an FCN is based on the VGG-16 network.

numClasses — Number of classes

integer greater than 1

Number of classes in the semantic segmentation, specified as an integer greater than 1.

type — Type of FCN model

'8s' (default) | '16s' | '32s'

Type of FCN model, specified as one of the following:

FCN Model	Description
'32s'	Upsamples the final feature map by a factor of 32. This option provides coarse segmentation with a lower computational cost.
'16s'	Upsamples the final feature map by a factor of 16 after fusing the feature map from the fourth pooling layer. This additional information from earlier layers provides medium-grain segmentation at the cost of additional computation.
'8s'	Upsamples the final feature map by a factor of 8 after fusing feature maps from the third and fourth max pooling layers. This additional information from earlier layers provides finer-grain segmentation at the cost of additional computation.

Output Arguments

lgraph — Layers

LayerGraph object

Layers that represent the FCN network architecture, returned as a `layerGraph` object.

All transposed convolution layers are initialized using bilinear interpolation weights. All transposed convolution layer bias terms are fixed to zero.

Tips

- Networks produced by `fcnLayers` support GPU code generation for deep learning once they are trained with `trainNetwork`. See “Deep Learning Code Generation” (Deep Learning Toolbox) for details and examples.

References

- [1] Long, J., E. Shelhamer, and T. Darrell. "Fully Convolutional Networks for Semantic Segmentation." *Proceedings of the IEEE Conference on Computer Vision and Pattern Recognition*, 2015, pp. 3431-3440.

See Also

Objects

`pixelClassificationLayer` | `layerGraph`

Functions

`fcnLayers` | `segnetLayers` | `unetLayers` | `trainNetwork` | `semanticseg` | `deeplabv3plusLayers`

Topics

"Getting Started with Semantic Segmentation Using Deep Learning"
"Deep Learning in MATLAB" (Deep Learning Toolbox)

Introduced in R2017b

segnetLayers

Create SegNet layers for semantic segmentation

Syntax

```
lgraph = segnetLayers(imageSize,numClasses,model)
lgraph = segnetLayers(imageSize,numClasses,encoderDepth)
lgraph = segnetLayers(imageSize,numClasses,encoderDepth,Name,Value)
```

Description

`lgraph = segnetLayers(imageSize,numClasses,model)` returns SegNet layers, `lgraph`, that is preinitialized with layers and weights from a pretrained model.

SegNet is a convolutional neural network for semantic image segmentation. The network uses a `pixelClassificationLayer` to predict the categorical label for every pixel in an input image.

Use `segnetLayers` to create the network architecture for SegNet. You must train the network using the Deep Learning Toolbox function `trainNetwork`.

`lgraph = segnetLayers(imageSize,numClasses,encoderDepth)` returns uninitialized SegNet layers configured using the specified encoder depth.

`lgraph = segnetLayers(imageSize,numClasses,encoderDepth,Name,Value)` returns a SegNet layer with additional options specified by one or more `Name, Value` pair arguments.

Examples

Train SegNet

Load training images and pixel labels.

```
dataSetDir = fullfile(toolboxdir('vision'),'visiondata','triangleImages');
imageDir = fullfile(dataSetDir,'trainingImages');
labelDir = fullfile(dataSetDir,'trainingLabels');
```

Create an image datastore holding the training images.

```
imds = imageDatastore(imageDir);
```

Define the class names and their associated label IDs.

```
classNames = ["triangle", "background"];
labelIDs = [255 0];
```

Create a pixel label datastore holding the ground truth pixel labels for the training images.

```
pxds = pixelLabelDatastore(labelDir,classNames,labelIDs);
```

Create SegNet layers.

```
imageSize = [32 32];
numClasses = 2;
lgraph = segnetLayers(imageSize,numClasses,2)
```

```
lgraph =
  LayerGraph with properties:

    Layers: [31x1 nnet.cnn.layer.Layer]
  Connections: [34x2 table]
  InputNames: {'inputImage'}
  OutputNames: {'pixelLabels'}
```

Combine image and pixel label data for training a semantic segmentation network.

```
ds = combine(imds,pxds);
```

Set up training options.

```
options = trainingOptions('sgdm','InitialLearnRate',1e-3, ...
  'MaxEpochs',20,'VerboseFrequency',10);
```

Train the network.

```
net = trainNetwork(ds,lgraph,options)
```

```
Training on single CPU.
Initializing input data normalization.
```

Epoch	Iteration	Time Elapsed (hh:mm:ss)	Mini-batch Accuracy	Mini-batch Loss	Base Learning Rate
1	1	00:00:05	39.70%	0.7665	0.0010
10	10	00:00:30	50.17%	0.7384	0.0010
20	20	00:00:59	66.13%	0.6920	0.0010

```
Training finished: Max epochs completed.
```

```
net =
  DAGNetwork with properties:

    Layers: [31x1 nnet.cnn.layer.Layer]
  Connections: [34x2 table]
  InputNames: {'inputImage'}
  OutputNames: {'pixelLabels'}
```

Display the network.

```
plot(lgraph)
```

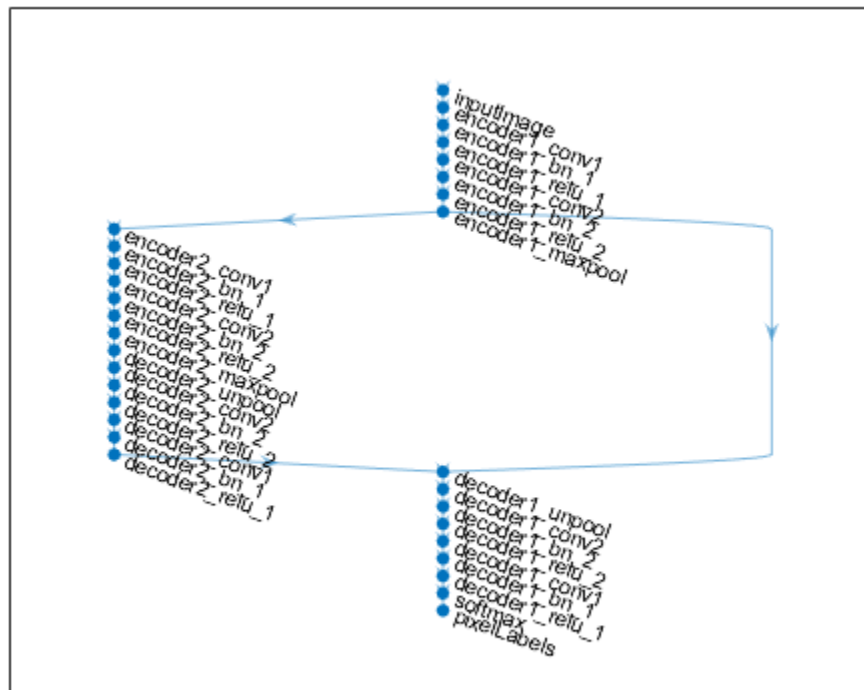

Create SegNet With Custom Encoder-Decoder Depth

Create SegNet layers with an encoder/decoder depth of 4.

```
imageSize = [480 640 3];
numClasses = 5;
encoderDepth = 4;
lgraph = segnetLayers(imageSize,numClasses,encoderDepth)
```

```
lgraph =
  LayerGraph with properties:
```

```
    Layers: [59x1 nnet.cnn.layer.Layer]
 Connections: [66x2 table]
 InputNames: {'inputImage'}
 OutputNames: {'pixelLabels'}
```

Display network.

```
figure
plot(lgraph)
```

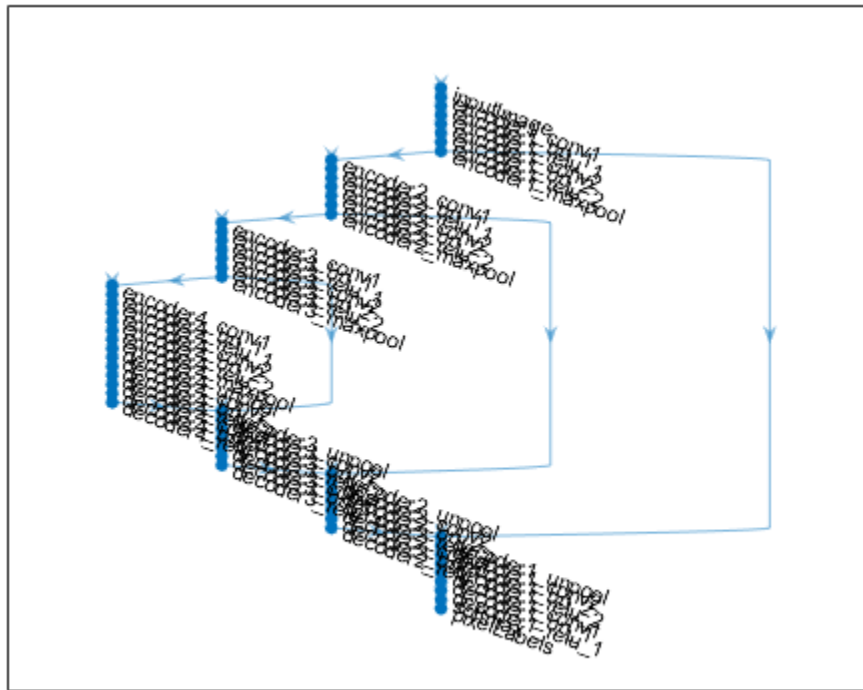

Input Arguments

imageSize — Network input image size

2-element vector | 3-element vector

Network input image size, specified as a:

- 2-element vector in the format $[height, width]$.
- 3-element vector in the format $[height, width, depth]$. $depth$ is the number of image channels. Set $depth$ to 3 for RGB images, 1 for grayscale images, or to the number of channels for multispectral and hyperspectral images.

numClasses — Number of classes

integer greater than 1

Number of classes in the semantic segmentation, specified as an integer greater than 1.

model — Pretrained network model

'vgg16' | 'vgg19'

Pretrained network model, specified as 'vgg16' or 'vgg19'. These models have an encoder depth of 5. When you use a 'vgg16' model, you must specify RGB inputs. You can convert grayscale images to RGB using the `im2gray` function.

encoderDepth — Encoder depth

positive integer

Encoder depth, specified as a positive integer.

SegNet is composed of an encoder and corresponding decoder subnetwork. The depth of these networks determines the number of times the input image is downsampled or upsampled as it is processed. The encoder network downsamples the input image by a factor of 2^D , where D is the value of `encoderDepth`. The decoder network upsamples the encoder network output by a factor of 2^D .

Name-Value Pair Arguments

Specify optional comma-separated pairs of `Name`, `Value` arguments. `Name` is the argument name and `Value` is the corresponding value. `Name` must appear inside quotes. You can specify several name and value pair arguments in any order as `Name1, Value1, ..., NameN, ValueN`.

Example: `'NumConvolutionLayers', 1`

NumConvolutionLayers — Number of convolutional layer sections

2 (default) | positive integer | vector of positive integers

Number of convolutional layers in each encoder and decoder section, specified as a positive integer or vector of positive integers.

NumConvolutionLayers	Description
scalar	The same number of layers is used for all encoder and decoder sections.
vector	The k th element of <code>NumConvolutionLayers</code> is the number of convolution layers in the k th encoder section and corresponding decoder section. Typical values are in the range [1, 3].

NumOutputChannels — Number of output channels

64 (default) | positive integer | vector of positive integers

Number of output channels for each section in the SegNet encoder network, specified as a positive integer or vector of positive integers. `segnetLayers` sets the number of output channels in the decoder to match the corresponding encoder section.

NumOutputChannels	Description
scalar	The same number of output channels is used for all encoder and decoder sections.
vector	The k th element of <code>NumOutputChannels</code> is the number of output channels of the k th encoder section and corresponding decoder section.

FilterSize — Convolutional layer filter size

3 (default) | positive odd integer | 2-element row vector of positive odd integers

Convolutional layer filter size, specified as a positive odd integer or a 2-element row vector of positive odd integers. Typical values are in the range [3, 7].

FilterSize	Description
scalar	The filter is square.
2-element row vector	The filter has the size [<i>height width</i>].

Output Arguments

lgraph — Layers

LayerGraph object

Layers that represent the SegNet network architecture, returned as a layerGraph object.

Tips

- The sections within the SegNet encoder and decoder subnetworks are made up of convolutional, batch normalization, and ReLU layers.
- All convolutional layers are configured such that the bias term is fixed to zero.
- Convolution layer weights in the encoder and decoder subnetworks are initialized using the 'MSRA' weight initialization method. For 'vgg16' or 'vgg19' models, only the decoder subnetwork is initialized using MSRA.[1]
- Networks produced by segnetLayers support GPU code generation for deep learning once they are trained with trainNetwork. See “Deep Learning Code Generation” (Deep Learning Toolbox) for details and examples.

References

- [1] He, K., X. Zhang, S. Ren, and J. Sun. "Delving Deep Into Rectifiers: Surpassing Human-Level Performance on ImageNet Classification." *Proceedings of the IEEE International Conference on Computer Vision*. 2015, 1026-1034.
- [2] Badrinarayanan, V., A. Kendall, and R. Cipolla. "Segnet: A Deep Convolutional Encoder-Decoder Architecture for Image Segmentation." *arXiv*. Preprint arXiv: 1511.0051, 2015.

Extended Capabilities

GPU Code Generation

Generate CUDA® code for NVIDIA® GPUs using GPU Coder™.

Usage notes and limitations:

For code generation, you must first create a SegNet network by using the segnetLayers function. Then, use the trainNetwork function on the resulting lgraph object to train the network for segmentation. Once the network is trained and evaluated, you can generate code for the DAGNetwork object using GPU Coder.

See Also

Objects

pixelClassificationLayer | layerGraph | DAGNetwork

Functions

fcnLayers | segnetLayers | unetLayers | trainNetwork | semanticseg |
deeplabv3plusLayers | evaluateSemanticSegmentation

Topics

“Getting Started with Semantic Segmentation Using Deep Learning”
“Deep Learning in MATLAB” (Deep Learning Toolbox)

Introduced in R2017b

unetLayers

Create U-Net layers for semantic segmentation

Syntax

```
lgraph = unetLayers(imageSize,numClasses)
[lgraph,outputSize] = unetLayers(imageSize,numClasses)
___ = unetLayers(imageSize,numClasses,Name,Value)
```

Description

`lgraph = unetLayers(imageSize,numClasses)` returns a U-Net network. `unetLayers` includes a pixel classification layer in the network to predict the categorical label for every pixel in an input image.

Use `unetLayers` to create the U-Net network architecture. You must train the network using the Deep Learning Toolbox function `trainNetwork`.

`[lgraph,outputSize] = unetLayers(imageSize,numClasses)` also returns the size of the output size from the U-Net network.

`___ = unetLayers(imageSize,numClasses,Name,Value)` specifies options using one or more name-value pair arguments. Enclose each property name in quotes. For example, `unetLayers(imageSize,numClasses,'NumFirstEncoderFilters',64)` additionally sets the number of output channels to 64 for the first encoder stage.

Examples

Create U-Net Network with Custom Encoder-Decoder Depth

Create a U-Net network with an encoder-decoder depth of 3.

```
imageSize = [480 640 3];
numClasses = 5;
encoderDepth = 3;
lgraph = unetLayers(imageSize,numClasses,'EncoderDepth',encoderDepth)
```

```
lgraph =
  LayerGraph with properties:
    Layers: [46x1 nnet.cnn.layer.Layer]
    Connections: [48x2 table]
    InputNames: {'ImageInputLayer'}
    OutputNames: {'Segmentation-Layer'}
```

Display the network.

```
plot(lgraph)
```

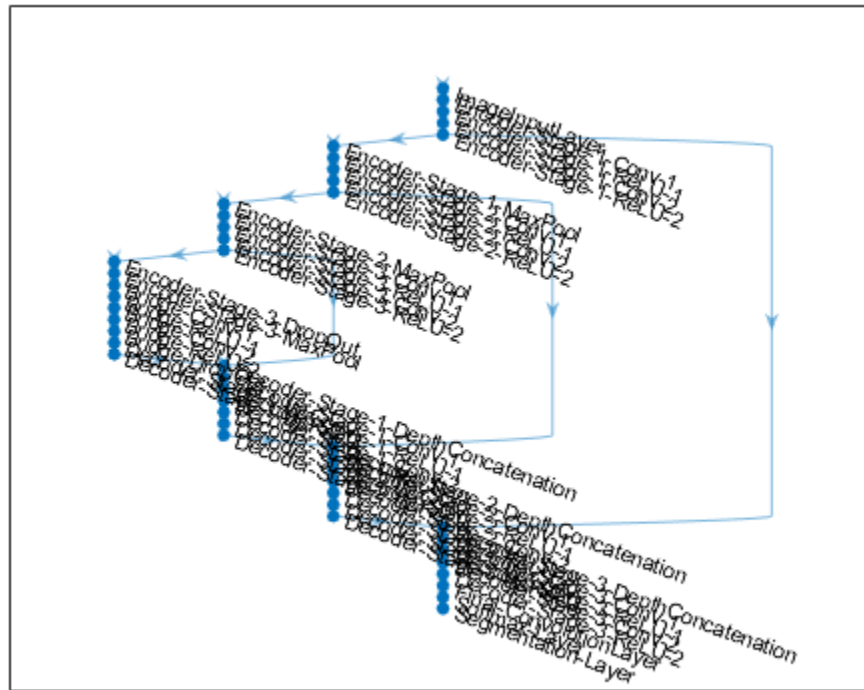

Train U-Net Network for Semantic Segmentation

Load training images and pixel labels into the workspace.

```
dataSetDir = fullfile(toolboxdir('vision'),'visiondata','triangleImages');
imageDir = fullfile(dataSetDir,'trainingImages');
labelDir = fullfile(dataSetDir,'trainingLabels');
```

Create an `imageDatastore` object to store the training images.

```
imds = imageDatastore(imageDir);
```

Define the class names and their associated label IDs.

```
classNames = ["triangle","background"];
labelIDs = [255 0];
```

Create a `pixelLabelDatastore` object to store the ground truth pixel labels for the training images.

```
pxds = pixelLabelDatastore(labelDir,classNames,labelIDs);
```

Create the U-Net network.

```

imageSize = [32 32];
numClasses = 2;
lgraph = unetLayers(imageSize, numClasses)

lgraph =
  LayerGraph with properties:

      Layers: [58x1 nnet.cnn.layer.Layer]
  Connections: [61x2 table]
  InputNames: {'ImageInputLayer'}
  OutputNames: {'Segmentation-Layer'}

```

Create a datastore for training the network.

```
ds = combine(imds,pxds);
```

Set training options.

```

options = trainingOptions('sgdm', ...
    'InitialLearnRate',1e-3, ...
    'MaxEpochs',20, ...
    'VerboseFrequency',10);

```

Train the network.

```
net = trainNetwork(ds,lgraph,options)
```

Training on single CPU.
Initializing input data normalization.

Epoch	Iteration	Time Elapsed (hh:mm:ss)	Mini-batch Accuracy	Mini-batch Loss	Base Learning Rate
1	1	00:00:04	75.57%	2.4341	0.0010
10	10	00:00:36	96.02%	0.4517	0.0010
20	20	00:01:13	97.62%	0.2324	0.0010

```

net =
  DAGNetwork with properties:

      Layers: [58x1 nnet.cnn.layer.Layer]
  Connections: [61x2 table]
  InputNames: {'ImageInputLayer'}
  OutputNames: {'Segmentation-Layer'}

```

Input Arguments

imageSize — Network input image size

2-element vector | 3-element vector

Network input image size, specified as a:

- 2-element vector in the form [*height*, *width*].

- 3-element vector in the form [*height*, *width*, *depth*]. *depth* is the number of image channels. Set *depth* to 3 for RGB images, to 1 for grayscale images, or to the number of channels for multispectral and hyperspectral images.

Data Types: `single` | `double` | `int8` | `int16` | `int32` | `int64` | `uint8` | `uint16` | `uint32` | `uint64`

numClasses — Number of classes

integer greater than 1

Number of classes in the semantic segmentation, specified as an integer greater than 1.

Data Types: `single` | `double` | `int8` | `int16` | `int32` | `int64` | `uint8` | `uint16` | `uint32` | `uint64`

Name-Value Pair Arguments

Example: `'EncoderDepth',3`

EncoderDepth — Encoder depth

4 (default) | positive integer

Encoder depth, specified as a positive integer. U-Net is composed of an encoder subnetwork and a corresponding decoder subnetwork. The depth of these networks determines the number of times the input image is downsampled or upsampled during processing. The encoder network downsamples the input image by a factor of 2^D , where D is the value of `EncoderDepth`. The decoder network upsamples the encoder network output by a factor of 2^D .

Data Types: `single` | `double` | `int8` | `int16` | `int32` | `int64` | `uint8` | `uint16` | `uint32` | `uint64`

NumOutputChannels — Number of output channels

64 (default) | positive integer

Note `NumOutputChannels` is renamed to `NumFirstEncoderFilters` and will not be supported in a future release. Use `NumFirstEncoderFilters` instead.

Number of output channels for the first encoder stage, specified as a positive integer or vector of positive integers. In each subsequent encoder stage, the number of output channels doubles. `UNETLayers` sets the number of output channels in each decoder stage to match the number in the corresponding encoder stage.

Data Types: `single` | `double` | `int8` | `int16` | `int32` | `int64` | `uint8` | `uint16` | `uint32` | `uint64`

NumFirstEncoderFilters — Number of output channels for first encoder

32 (default) | positive integer

Number of output channels for the first encoder stage, specified as a positive integer or vector of positive integers. In each subsequent encoder stage, the number of output channels doubles. The `UNETLayers` function sets the number of output channels in each decoder stage to match the number in the corresponding encoder stage.

Data Types: `single` | `double` | `int8` | `int16` | `int32` | `int64` | `uint8` | `uint16` | `uint32` | `uint64`

FilterSize — Convolutional layer filter size

3 (default) | positive odd integer | 2-element row vector of positive odd integers

Convolutional layer filter size, specified as a positive odd integer or a 2-element row vector of positive odd integers. Typical values are in the range [3, 7].

FilterSize	Description
scalar	The filter is square.
2-element row vector	The filter has the size [<i>height width</i>].

Data Types: `single` | `double` | `int8` | `int16` | `int32` | `int64` | `uint8` | `uint16` | `uint32` | `uint64`

ConvolutionPadding — Type of padding

'same' (default) | 'valid'

Type of padding, specified as 'same' or 'valid'. The type of padding specifies the padding style for the `convolution2dLayer` in the encoder and the decoder subnetworks. The spatial size of the output feature map depends on the type of padding. If you specify type of padding as:

- 'same' — Zero padding is applied to the inputs to convolution layers such that the output and input feature maps are the same size.
- 'valid' — Zero padding is not applied to the inputs to convolution layers. The convolution layer returns only values of the convolution that are computed without zero padding. The output feature map is smaller than the input feature map.

Note To ensure that the *height* and *width* of the inputs to max-pooling layers are even, choose the network input image size to confirm to any one of these criteria:

- If you specify 'ConvolutionPadding' as 'same', then the *height* and *width* of the input image must be a multiple of 2^D .
- If you specify 'ConvolutionPadding' as 'valid', then the *height* and *width* of the input image must be chosen such that $height - \sum_{i=1}^D 2^i(f_h - 1)$ and $width - \sum_{i=1}^D 2^i(f_w - 1)$ are multiples of 2^D .

where f_h and f_w are the height and width of the two-dimensional convolution kernel, respectively. D is the encoder depth.

Data Types: `char` | `string`

Output Arguments

lgraph — Layers

layerGraph object

Layers that represent the U-Net network architecture, returned as a `layerGraph` object.

outputSize — Network output image size

three-element vector

Network output image size, returned as a three-element vector of the form [*height, width, channels*]. *channels* is the number of output channels and it is equal to the number of classes specified at the input. The *height* and *width* of the output image from the network depend on the type of padding convolution.

- If you specify 'ConvolutionPadding' as 'same', then the *height* and *width* of the network output image are the same as that of the network input image.

- If you specify 'ConvolutionPadding' as 'valid', then the *height* and *width* of the network output image are less than that of the network input image.

Data Types: double

More About

U-Net Architecture

- The U-Net architecture consists of an encoder subnetwork and decoder subnetwork that are connected by a bridge section.
- The encoder and decoder subnetworks in the U-Net architecture consists of multiple stages. EncoderDepth, which specifies the depth of the encoder and decoder subnetworks, sets the number of stages.
- The stages within the U-Net encoder subnetwork consist of two sets of convolutional and ReLU layers, followed by a 2-by-2 max pooling layer. The decoder subnetwork consists of a transposed convolution layer for upsampling, followed by two sets of convolutional and ReLU layers.
- The bridge section consists of two sets of convolution and ReLU layers.
- The bias term of all convolutional layers is initialized to zero.
- Convolution layer weights in the encoder and decoder subnetworks are initialized using the 'He' weight initialization method [2].

Tips

- Use 'same' padding in convolution layers to maintain the same data size from input to output and enable the use of a broad set of input image sizes.
- Use patch-based approaches for seamless segmentation of large images. You can extract image patches by using the randomPatchExtractionDatastore function in Image Processing Toolbox.
- Use 'valid' padding to prevent border artifacts while you use patch-based approaches for segmentation.
- You can use the network created using unetLayers function for GPU code generation after training with trainNetwork. For details and examples, see “Deep Learning Code Generation” (Deep Learning Toolbox).

Compatibility Considerations

NumOutputChannels argument in **unetLayers** is renamed to **NumFirstEncoderFilters**

Not recommended starting in R2019b

unetLayers argument NumOutputChannels is renamed to NumFirstEncoderFilters. NumOutputChannels will not be supported in a future release. Use NumFirstEncoderFilters instead. To update your code, replace all instances of NumOutputChannels with NumFirstEncoderFilters.

References

- [1] Ronneberger, O., P. Fischer, and T. Brox. "U-Net: Convolutional Networks for Biomedical Image Segmentation." *Medical Image Computing and Computer-Assisted Intervention (MICCAI)*. Vol. 9351, 2015, pp. 234-241.
- [2] He, K., X. Zhang, S. Ren, and J. Sun. "Delving Deep Into Rectifiers: Surpassing Human-Level Performance on ImageNet Classification." *Proceedings of the IEEE International Conference on Computer Vision*. 2015, 1026-1034.

Extended Capabilities

GPU Code Generation

Generate CUDA® code for NVIDIA® GPUs using GPU Coder™.

Usage notes and limitations:

You can use the U-Net network for code generation. First, create the network using the `unetLayers` function. Then, use the `trainNetwork` function to train the network for segmentation. After training and evaluating the network, you can generate code for the `DAGNetwork` object by using GPU Coder.

See Also

Objects

`pixelClassificationLayer` | `layerGraph` | `DAGNetwork`

Functions

`fcnLayers` | `segnetLayers` | `trainNetwork` | `semanticseg` | `deeplabv3plusLayers` | `evaluateSemanticSegmentation`

Topics

"Semantic Segmentation of Multispectral Images Using Deep Learning"
"Getting Started with Semantic Segmentation Using Deep Learning"
"Deep Learning in MATLAB" (Deep Learning Toolbox)

Introduced in R2018b

UNET3DLAYERS

Create 3-D U-Net layers for semantic segmentation of volumetric images

Syntax

```
lgraph = unet3dLayers(inputSize,numClasses)
[lgraph,outputSize] = unet3dLayers(inputSize,numClasses)
[ ___ ] = unet3dLayers(inputSize,numClasses,Name,Value)
```

Description

`lgraph = unet3dLayers(inputSize,numClasses)` returns a 3-D U-Net network. `UNET3DLAYERS` includes a pixel classification layer in the network to predict the categorical label for each pixel in an input volumetric image.

Use `UNET3DLAYERS` to create the network architecture for 3-D U-Net. Train the network using the Deep Learning Toolbox function `TRAINNETWORK`.

`[lgraph,outputSize] = unet3dLayers(inputSize,numClasses)` also returns the size of an output volumetric image from the 3-D U-Net network.

`[___] = unet3dLayers(inputSize,numClasses,Name,Value)` specifies options using one or more name-value pair arguments in addition to the input arguments in previous syntax.

Examples

Create 3-D U-Net Network with Custom Encoder-Decoder Depth

Create a 3-D U-Net network with an encoder-decoder depth of 2. Specify the number of output channels for the first convolution layer as 16.

```
imageSize = [128 128 128 3];
numClasses = 5;
encoderDepth = 2;
lgraph = unet3dLayers(imageSize,numClasses,'EncoderDepth',encoderDepth,'NumFirstEncoderFilters',16);

lgraph =
    LayerGraph with properties:

        Layers: [40x1 nnet.cnn.layer.Layer]
        Connections: [41x2 table]
        InputNames: {'ImageInputLayer'}
        OutputNames: {'Segmentation-Layer'}
```

Display the network.

```
figure('Units','Normalized','Position',[0 0 0.5 0.55]);
plot(lgraph)
```

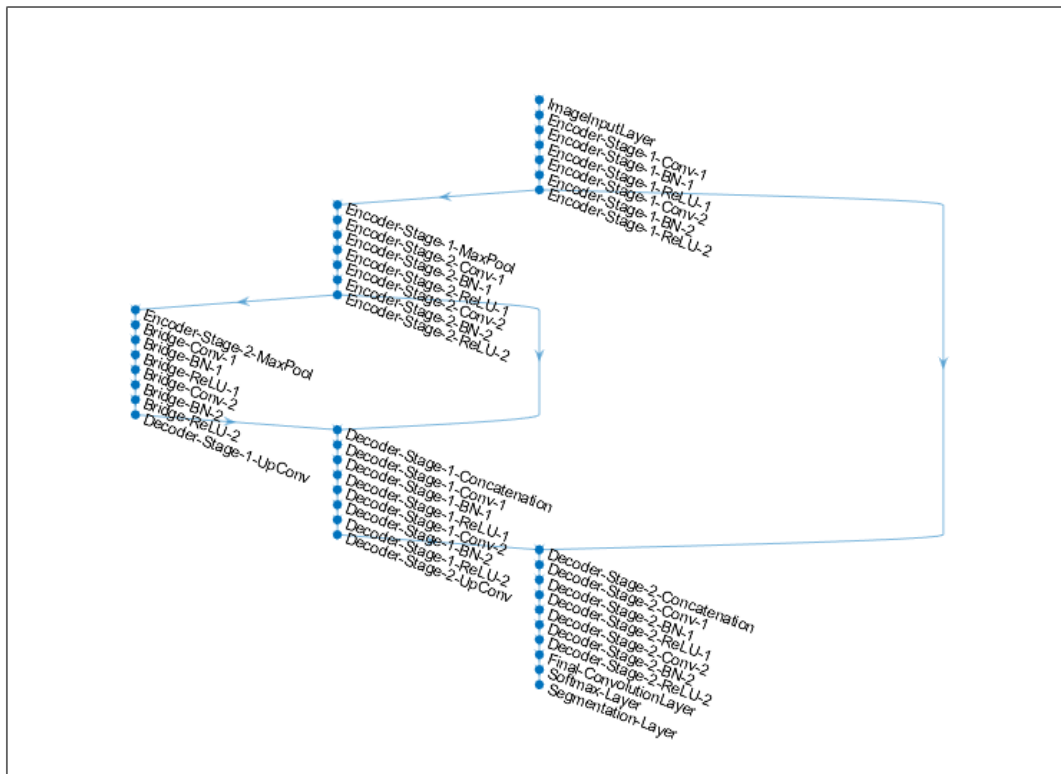

Use the deep learning network analyzer to visualize the 3-D U-Net network.

```
analyzeNetwork(lgraph);
```

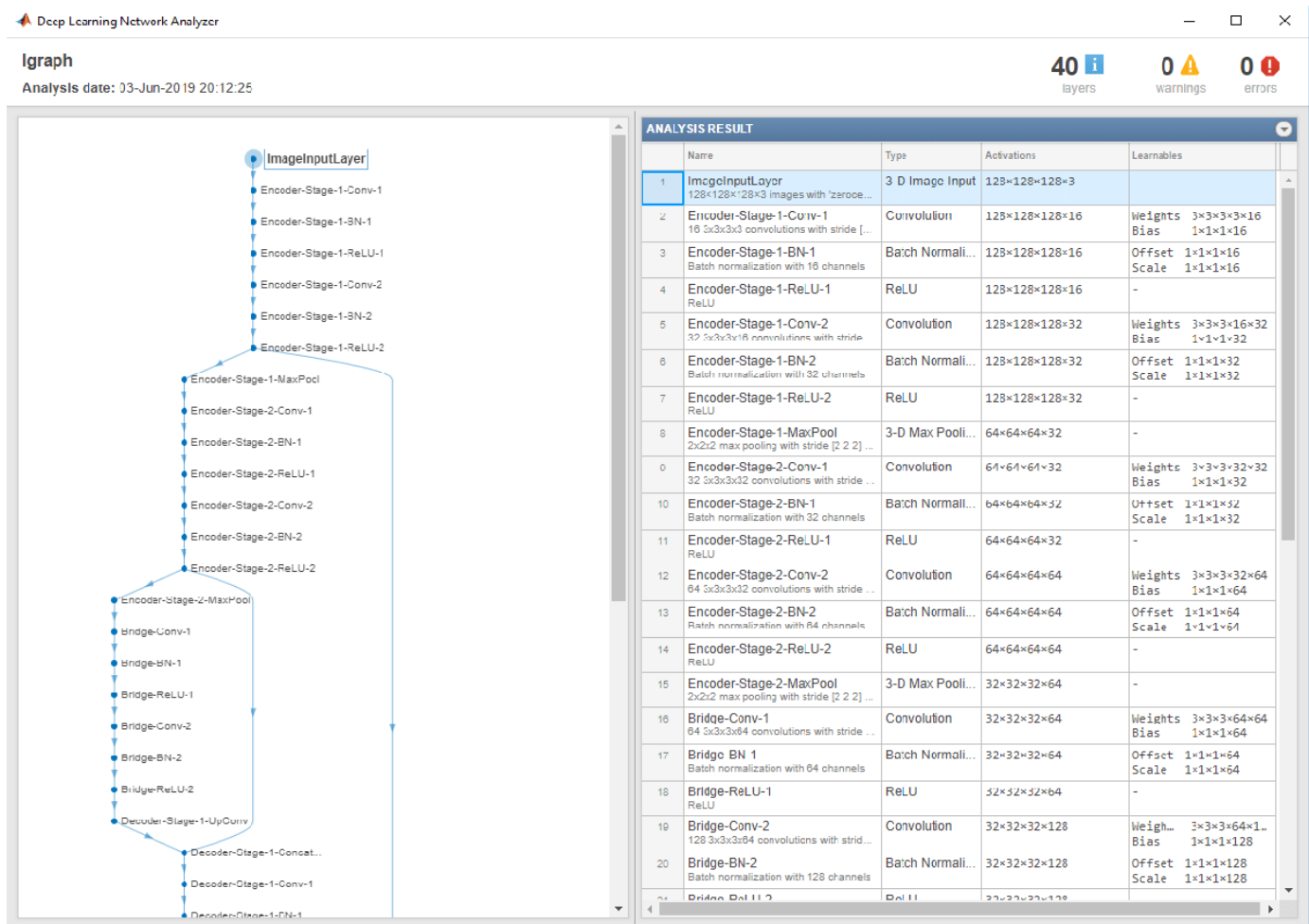

The visualization shows the number of output channels for each encoder stage. The first convolution layers in encoder stages 1 and 2 have 16 and 32 output channels, respectively. The second convolution layers in encoder stages 1 and 2 have 32 and 64 output channels, respectively.

Input Arguments

inputSize — Network input image size
three-element vector | four-element vector

Network input image size representing a volumetric image, specified as one of these values:

- Three-element vector of the form $[height\ width\ depth]$
- Four-element vector of the form $[height\ width\ depth\ channel]$. *channel* denotes the number of image channels.

Note Network input image size must be chosen such that the dimension of the inputs to the max-pooling layers must be even numbers.

Data Types: `single` | `double` | `int8` | `int16` | `int32` | `int64` | `uint8` | `uint16` | `uint32` | `uint64`

numClasses — Number of classes

scalar greater than 1

Number of classes to segment, specified as a scalar greater than 1.

Data Types: `single` | `double` | `int8` | `int16` | `int32` | `int64` | `uint8` | `uint16` | `uint32` | `uint64`

Name-Value Pair Arguments

Specify optional comma-separated pairs of `Name`, `Value` arguments. `Name` is the argument name and `Value` is the corresponding value. `Name` must appear inside quotes. You can specify several name and value pair arguments in any order as `Name1, Value1, ..., NameN, ValueN`.

Example: `UNET3DLAYERS(inputSize,numClasses,'EncoderDepth',4)`

EncoderDepth — Encoder depth

3 (default) | positive integer

Encoder depth, specified as a positive integer. The 3-D U-Net network is composed of an encoder subnetwork and a corresponding decoder subnetwork. The depth of the network determines the number of times the input volumetric image is downsampled or upsampled during processing. The encoder network downsamples the input volumetric image by a factor of 2^D , where D is the value of `EncoderDepth`. The decoder network upsamples the encoder network output by a factor of 2^D . The depth of the decoder subnetwork is same as that of the encoder subnetwork.

Data Types: `single` | `double` | `int8` | `int16` | `int32` | `int64` | `uint8` | `uint16` | `uint32` | `uint64`

NumFirstEncoderFilters — Number of output channels for first convolution layer

32 (default) | positive integer

Number of output channels for the first convolution layer in the first encoder stage, specified as a positive integer. The number of output channels for the second convolution layer and the convolution layers in the subsequent encoder stages is set based on this value.

Given stage = {1, 2, ..., `EncoderDepth`}, the number of output channels for the first convolution layer in each encoder stage is equal to

$$2^{stage-1} \text{NumFirstEncoderFilters}$$

The number of output channels for the second convolution layer in each encoder stage is equal to

$$2^{stage} \text{NumFirstEncoderFilters}$$

The `UNET3DLAYERS` function sets the number of output channels for convolution layers in the decoder stages to match the number in the corresponding encoder stage.

Data Types: `single` | `double` | `int8` | `int16` | `int32` | `int64` | `uint8` | `uint16` | `uint32` | `uint64`

FilterSize — Size of 3-D convolution filter

3 (default) | positive scalar integer | three-element row vector of positive integers

Size of the 3-D convolution filter, specified as a positive scalar integer or a three-element row vector of positive integers of the form $[f_h \ f_w \ f_d]$. Typical values for filter dimensions are in the range [3, 7].

If you specify '`FilterSize`' as a positive scalar integer of value a , then the convolution kernel is of uniform size $[a \ a \ a]$.

Data Types: `single` | `double` | `int8` | `int16` | `int32` | `int64` | `uint8` | `uint16` | `uint32` | `uint64`

ConvolutionPadding — Type of padding

`'same'` (default) | `'valid'`

Type of padding, specified as `'same'` or `'valid'`. The type of padding specifies the padding style for the `convolution3dLayer` in the encoder and the decoder subnetworks. The spatial size of the output feature map depends on the type of padding. Specify one of these options:

- `'same'` — Zero padding is applied to the inputs to convolution layers such that the output and input feature maps are the same size.
- `'valid'` — Zero padding is not applied to the inputs to convolution layers. The convolution layer returns only values of the convolution that are computed without zero padding. The output feature map is smaller than the input feature map.

Note To ensure that the *height*, *width*, and *depth* values of the inputs to max-pooling layers are even, choose the network input image size to confirm to any one of these criteria:

- If you specify `'ConvolutionPadding'` as `'same'`, then the *height*, *width*, and *depth* of the input volumetric image must be a multiple of 2^D .
- If you specify `'ConvolutionPadding'` as `'valid'`, then the *height*, *width*, and *depth* of the input volumetric image must be chosen such that $height - \sum_{i=1}^D 2^i(f_h - 1)$, $width - \sum_{i=1}^D 2^i(f_w - 1)$, and $depth - \sum_{i=1}^D 2^i(f_d - 1)$ are multiples of 2^D .

where f_h , f_w and f_d are the height, width, and depth of the three-dimensional convolution kernel, respectively. D is the encoder depth.

Data Types: `char` | `string`

Output Arguments

lgraph — Layers

`layerGraph` object

Layers that represent the 3-D U-Net network architecture, returned as a `layerGraph` object.

outputSize — Network output image size

four-element vector

Network output image size, returned as a four-element vector of the form `[height, width, depth, channels]`. *channels* is the number of output channels and is equal to the number of classes specified at the input. The *height*, *width*, and *depth* of the output image from the network depend on the type of padding convolution.

- If you specify `'ConvolutionPadding'` as `'same'`, then the *height*, *width*, and *depth* of the network output image are the same as that of the network input image.

- If you specify 'ConvolutionPadding' as 'valid', then the *height*, *width*, and *depth* of the network output image are less than that of the network input image.

Data Types: double

More About

3-D U-Net Architecture

- The 3-D U-Net architecture consists of an encoder subnetwork and decoder subnetwork that are connected by a bridge section.
- The encoder and decoder subnetworks in the 3-D U-Net architecture consist of multiple stages. `EncoderDepth`, which specifies the depth of the encoder and decoder subnetworks, sets the number of stages.
- Each encoder stage in the 3-D U-Net network consists of two sets of convolutional, batch normalization, and ReLU layers. The ReLU layer is followed by a 2-by-2-by-2 max pooling layer. Likewise, each decoder stage consists of a transposed convolution layer for upsampling, followed by two sets of convolutional, batch normalization, and ReLU layers.
- The bridge section consists of two sets of convolution, batch normalization, and ReLU layers.
- The bias term of all convolution layers is initialized to zero.
- Convolution layer weights in the encoder and decoder subnetworks are initialized using the 'He' weight initialization method.

Tips

- Use 'same' padding in convolution layers to maintain the same data size from input to output and enable the use of a broad set of input image sizes.
- Use patch-based approaches for seamless segmentation of large images. You can extract image patches by using the `randomPatchExtractionDatastore` function in Image Processing Toolbox.
- Use 'valid' padding in convolution layers to prevent border artifacts while you use patch-based approaches for segmentation.

References

- [1] Çiçek, Ö., A. Abdulkadir, S. S. Lienkamp, T. Brox, and O. Ronneberger. "3D U-Net: Learning Dense Volumetric Segmentation from Sparse Annotation." *Medical Image Computing and Computer-Assisted Intervention – MICCAI 2016. MICCAI 2016. Lecture Notes in Computer Science*. Vol. 9901, pp. 424–432. Springer, Cham.

See Also

Objects

`pixelClassificationLayer` | `layerGraph` | `DAGNetwork` | `dicePixelClassificationLayer`

Functions

`fcnLayers` | `segnetLayers` | `unetLayers` | `trainNetwork` | `semanticseg` | `deeplabv3plusLayers` | `evaluateSemanticSegmentation`

Topics

“Getting Started with Semantic Segmentation Using Deep Learning”

“Deep Learning in MATLAB” (Deep Learning Toolbox)

Introduced in R2019b

countEachLabel

Count occurrence of pixel or box labels

Syntax

```
counts = countEachLabel(ds)
```

Description

`counts = countEachLabel(ds)` returns a table containing information about the pixel or box labels and count for the input datastore, `ds`.

Examples

Count Unique Labels in Datastore

Load a table that contains bounding boxes with labels for vehicles.

```
load('vehicleTrainingData.mat');
```

Load a table that contains bounding boxes with labels for stop signs and cars.

```
load('stopSignsAndCars.mat');
```

Combine ground truth boxes and labels, excluding the image filenames in the first column.

```
vehiclesTbl = vehicleTrainingData(:,2:end);
stopSignsTbl = stopSignsAndCars(:,2:end);
```

Create a boxLabelDatastore using 2 tables, one with vehicle label data and the other with stop signs label data.

```
blds = boxLabelDatastore(vehiclesTbl,stopSignsTbl);
tbl = countEachLabel(blds)
```

`tbl=4×3 table`

Label	Count	ImageCount
vehicle	336	295
stopSign	42	41
carRear	10	9
carFront	9	8

Create a histogram plot using the labels and the respective label counts.

```
histogram('Categories',tbl.Label,'BinCounts',tbl.Count);
```

Create another histogram overlaying the respective image counts.

```
hold on;
histogram('Categories',tbl.Label,'BinCounts',tbl.ImageCount);
```

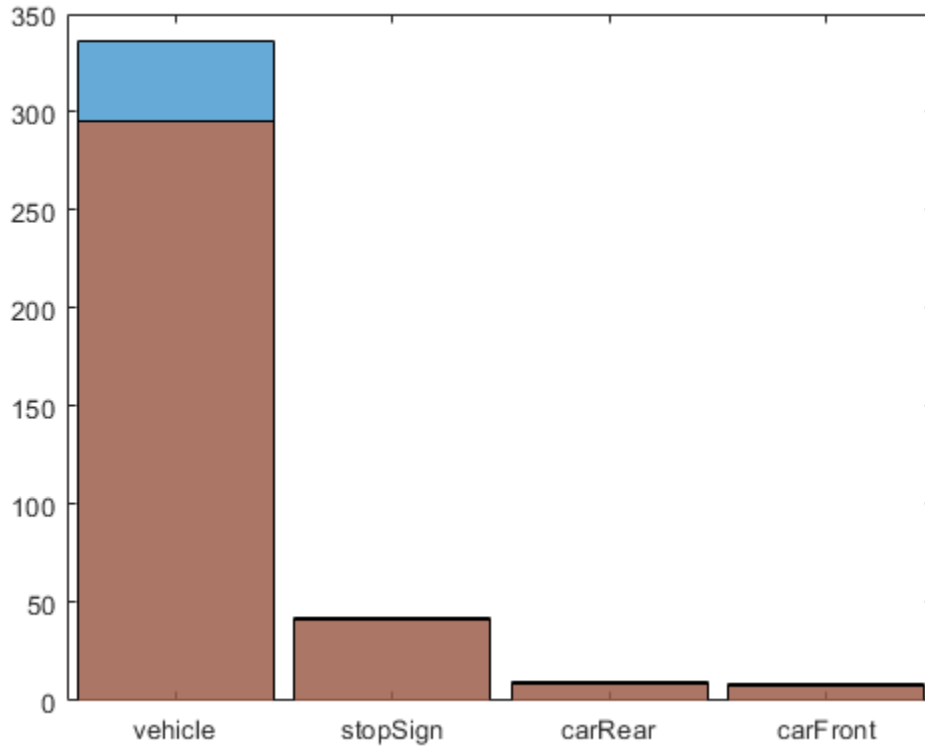

Pass Class Weights to Pixel Classification Layer

Set the location of image and pixel label data.

```
dataDir = fullfile(toolboxdir('vision'),'visiondata');
imDir = fullfile(dataDir,'building');
pxDir = fullfile(dataDir,'buildingPixelLabels');
```

Create a pixel label image datastore using the ground truth images in imds and the pixel labeled images in pxds.

```
imds = imageDatastore(imDir);
classNames = ["sky" "grass" "building" "sidewalk"];
pixelLabelID = [1 2 3 4];
pxds = pixelLabelDatastore(pxDir,classNames,pixelLabelID);
```

Tabulate pixel label counts in dataset.

```
tbl = countEachLabel(pxds)
```

```
tbl=4x3 table
      Name      PixelCount      ImagePixelCount
```

{'sky' }	3.1485e+05	1.536e+06
{'grass' }	1.5979e+05	1.536e+06
{'building' }	1.0312e+06	1.536e+06
{'sidewalk' }	25313	9.216e+05

Balance classes using uniform prior weighting.

```
prior = 1/numel(classNamees);
uniformClassWeights = prior./tbl.PixelCount
```

```
uniformClassWeights = 4×1
10-5 ×
```

```
0.0794
0.1565
0.0242
0.9876
```

Balance classes using inverse frequency weighting.

```
totalNumberOfPixels = sum(tbl.PixelCount);
frequency = tbl.PixelCount / totalNumberOfPixels;
invFreqClassWeights = 1./frequency
```

```
invFreqClassWeights = 4×1
```

```
4.8632
9.5827
1.4848
60.4900
```

Balance classes using median frequency weighting.

```
freq = tbl.PixelCount ./ tbl.ImagePixelCount
```

```
freq = 4×1
```

```
0.2050
0.1040
0.6714
0.0275
```

```
medFreqClassWeights = median(freq) ./ freq
```

```
medFreqClassWeights = 4×1
```

```
0.7538
1.4852
0.2301
5.6252
```

Pass the class weights using median frequency weighting to the pixel classification layer.

```
layer = pixelClassificationLayer('Classes',tbl.Name, ...
    'ClassWeights', medFreqClassWeights)
```

```
layer =
    PixelClassificationLayer with properties:

        Name: ''
        Classes: [sky    grass    building    sidewalk]
        ClassWeights: [4x1 double]
        OutputSize: 'auto'

    Hyperparameters
        LossFunction: 'crossentropyex'
```

Input Arguments

ds — Datastore with labeled data

PixelLabelDatastore object | pixelLabelImageDatastore object | boxLabelDatastore object

Datastore with labeled data for training a semantic segmentation network or an object detection network, specified as a pixelLabelDatastore, pixelLabelImageDatastore, or boxLabelDatastore object.

Output Arguments

counts — Label information

table

Label information, returned as a table. The labeled data table contain three variables.

For pixelLabelDatastore and pixelLabelImageDatastore inputs, the counts output contains:

Pixel Count Variables	Description
Name	Pixel label class name
PixelCount	Number of pixels in class
ImagePixelCount	Total number of pixels in images that had an instance of the class

For boxLabelDatastore inputs, the counts output table contains:

Box Count Variables	Description
Label	Box label class name
Count	Total number of labels of the class across all images
ImageCount	Total number of images that contain one or more instances of the class

Tips

The output of `countEachLabel` can be used to calculate class weights for class balancing. For example, for labeled pixel data information in `tbl`:

- Uniform class balancing weights each class such that each contains a uniform prior probability:

```
numClasses = height(tbl)
prior = 1/numClasses;
classWeights = prior./tbl.PixelCount
```

- Inverse frequency balancing weights each class such that underrepresented classes are given higher weight:

```
totalNumberOfPixels = sum(tbl.PixelCount)
frequency = tbl.PixelCount / totalNumberOfPixels;
classWeights = 1./frequency
```

- Median frequency balancing weights each class using the median frequency. The weight for each class is defined as $\text{median}(\text{imageFreq})/\text{imageFreq}(c)$, where $\text{imageFreq}(c)$ represents the number of pixels of the class divided by the total number of pixels in images that had an instance of the class (c):

```
imageFreq = tbl.PixelCount ./ tbl.ImagePixelCount
classWeights = median(imageFreq) ./ imageFreq
```

The calculated class weights can be passed to the `pixelClassificationLayer`.

See Also

Functions

`trainNetwork`

Objects

`pixelClassificationLayer` | `pixelLabelImageDatastore` | `boxLabelDatastore`

Introduced in R2017b

reset

Reset datastore to initial state

Syntax

```
reset(ds)
```

Description

`reset(ds)` resets the label datastore specified by `ds` to the state where no data has been read from it. Resetting the datastore enables you to read from it again.

Input Arguments

ds — Datastore with labeled data

PixelLabelDatastore object | pixelLabelImageDatastore object | boxLabelDatastore object

Datastore with labeled data for training a semantic segmentation network or an object detection network, specified as a `pixelLabelDatastore`, `pixelLabelImageDatastore`, or `boxLabelDatastore` object.

See Also

`trainNetwork` | `pixelClassificationLayer` | `pixelLabelImageDatastore` | `boxLabelDatastore`

Introduced in R2017b

readimage

Read specified pixel label data file

Syntax

```
C = readimage(pxds,k)
[C,info] = readimage(pxds,k)
```

Description

`C = readimage(pxds,k)` returns the *k*th file in the pixel label datastore specified by `pxds`.

`[C,info] = readimage(pxds,k)` also returns information about the extracted data in `info`, including metadata.

Input Arguments

pxds — Input pixel label datastore

PixelLabelDatastore object

Input pixel label datastore, specified as a PixelLabelDatastore object.

k — File number

positive integer

File number to read from the pixel label datastore, specified as a positive integer.

Output Arguments

C — Output data

categorical matrix

Output data, returned as a categorical matrix.

info — Information about read data

structure array

Information about read data, returned as a structure array. The structure array can contain the following fields.

Field Name	Description
Filename	Fully resolved path containing the path string, name of the file, and file extension.
FileSize	Total file size, in bytes.

See Also

datastore

Introduced in R2017b

readall

Read all data in datastore

Syntax

```
data = readall(ds)
```

Description

`data = readall(ds)` returns all the data contained in the label datastore specified by `ds`.

If all the data in the datastore does not fit in memory, then `readall` returns an error.

Input Arguments

ds — Datastore with labeled data

`PixelLabelDatastore` object | `pixelLabelImageDatastore` object | `boxLabelDatastore` object

Datastore with labeled data for training a semantic segmentation network or an object detection network, specified as a `pixelLabelDatastore`, `pixelLabelImageDatastore`, or `boxLabelDatastore` object.

Output Arguments

data — Output data

cell array of categorical matrices | M -by-2 cell array | table

Output data, returned as an M -by-2 cell array, cell array of categorical matrices, or a table.

Datastore	Output Description
<code>PixelLabelDatastore</code>	Table with <code>MiniBatchSize</code> number of rows. For the last batch of data in the datastore, <code>numObservations</code> must be divisible by <code>MiniBatchSize</code> or <code>read</code> returns a partial batch containing all the remaining observations in the datastore.
<code>PixelLabelImageDatastore</code>	
<code>boxLabelDatastore</code>	<p>N-by-2 cell matrix. N must be less than or equal to <code>ReadSize(ds)</code>.</p> <p>The first column must be a cell vector that contains bounding boxes. Each element in the cell vector contains M-by-4 matrices in the format <code>[x,y,width,height]</code>.</p> <p>The second column must be a cell vector that contains the label names corresponding to each bounding box. Label names are represented as an M-by-1 categorical vector.</p>

See Also

`trainNetwork` | `pixelClassificationLayer` | `pixelLabelImageDatastore` | `boxLabelDatastore`

Introduced in R2017b

partition

Partition a label datastore

Syntax

```
subds = partition(ds,N,index)

subds = partition(ds,'Files',fileIndex)
subds = partition(ds,'Files',filename)
```

Description

`subds = partition(ds,N,index)` partitions a datastore `ds` into N parts and returns the partition corresponding to `index`.

`subds = partition(ds,'Files',fileIndex)` partitions the `PixelLabelDatastore` or `pixelLabelImageDatastore` by files. The partitioned datastore corresponds to the `index` in the `Files` property of the datastore.

`subds = partition(ds,'Files',filename)` partitions the `PixelLabelDatastore` or `pixelLabelImageDatastore` by files. The partitioned datastore corresponds to the file specified by `filename`.

Examples

Partition a Datastore

Load training data that contains bounding boxes with labels for vehicles.

```
data = load('vehicleTrainingData.mat');
trainingData = data.vehicleTrainingData;
blds = boxLabelDatastore(trainingData(:,2:end));
```

Use the `partition` function to partition the box label datastore. The output contains the first 5 rows of the training data.

```
subds = partition(blds,59,5);
```

Read the data. Use the `hasdata` function to check for data.

```
while hasdata(subds)
    % Read one row of box labels at a time
    bxLabels = read(subds);
end
```

Input Arguments

ds — Datastore with labeled data

PixelLabelDatastore object | pixelLabelImageDatastore object | boxLabelDatastore object

Datastore with labeled data for training a semantic segmentation network or an object detection network, specified as a pixelLabelDatastore, pixelLabelImageDatastore, or boxLabelDatastore object.

N — Number of partitions

positive integer

Number of partitions to divide datastore, specified as a positive integer. To obtain an estimate for a reasonable number of partitions, use the numpartitions function.

```
numWorkers = 3;  
p = parpool('local',numWorkers);  
n = numpartitions(ds,p);
```

```
parfor ii=1:n  
    subds = partition(ds,n,ii);  
    while hasdata(subds)  
        data = read(subds);  
    end  
end
```

Example: 3

Data Types: double

index — Index

positive integer

Index, specified as an integer. The index points to a partitioned datastore of the N number of partitioned datastores.

Example: 1

Data Types: double

fileIndex — File index

positive integer

File index of a file stored within the Files property of a pixelLabelDatastore or pixelLabelImageDatastore, specified as a positive integer.

Example: 1

Data Types: double

filename — file name

character vector

File name, specified as a character vector.

Example: 'file1.csv'

Example: '../dir/data/file1.csv'

Example: 'hdfs://myserver:7867/data/file1.txt'

Data Types: char

Output Arguments

subds — Output datastore

datastore object

Output datastore, returned as a datastore object. The output datastore is of the same type as the input datastore, ds.

See Also

[trainNetwork](#) | [pixelClassificationLayer](#) | [pixelLabelImageDatastore](#) | [boxLabelDatastore](#)

Introduced in R2017b

numpartitions

Number of partitions for a datastore

Syntax

```
N = numpartitions(ds)
N = numpartitions(ds,pool)
```

Description

`N = numpartitions(ds)` returns the default number of partitions for a label datastore `ds`.

`N = numpartitions(ds,pool)` returns the number of partitions needed to parallelize datastore access over the parallel pool specified by `pool`. To parallelize datastore access, you must have Parallel Computing Toolbox installed.

Input Arguments

ds — Datastore with labeled data

`PixelLabelDatastore` object | `pixelLabelImageDatastore` object | `boxLabelDatastore` object

Datastore with labeled data for training a semantic segmentation network or an object detection network, specified as a `pixelLabelDatastore`, `pixelLabelImageDatastore`, or `boxLabelDatastore` object.

pool — Parallel pool

parallel pool object

Parallel pool object.

Example: `gcp`

See Also

Functions

`numpartitions` | `datastore`

Objects

`boxLabelDatastore` | `pixelLabelImageDatastore` | `pixelLabelDatastore`

Introduced in R2017b

hasdata

Determine if data is available to read from datastore

Syntax

```
tf = hasdata(ds)
```

Description

`tf = hasdata(ds)` returns logical 1 (true) if there is data available to read from the datastore specified by `ds`. Otherwise, it returns logical 0 (false).

Examples

Determine Pixel Data Available to Read

Check if pixel label data can be read from a datastore.

Set the location of the image and pixel label data.

```
dataDir = fullfile(toolboxdir('vision'),'visiondata');  
imDir = fullfile(dataDir,'building');  
pxDir = fullfile(dataDir,'buildingPixelLabels');
```

Create an image and pixel label datastore.

```
imds = imageDatastore(imDir);  
classNames = ["sky" "grass" "building" "sidewalk"];  
pixelLabelID = [1 2 3 4];  
pxds = pixelLabelDatastore(pxDir,classNames,pixelLabelID);
```

While data is available in the datastore, read the data.

```
while hasdata(pxds)  
    T = read(pxds);  
end
```

Input Arguments

ds — Datastore with labeled data

PixelLabelDatastore object | pixelLabelImageDatastore object | boxLabelDatastore object

Datastore with labeled data for training a semantic segmentation network or an object detection network, specified as a `pixelLabelDatastore`, `pixelLabelImageDatastore`, or `boxLabelDatastore` object.

Output Arguments

tf — Datastore data status

1 | 0

Datastore data status, returned as a logical 1 (`true`) if there is data available to read from the datastore specified by `ds`. Otherwise, it returns logical 0 (`false`).

See Also

`datastore` | `pixelLabelDatastore` | `boxLabelDatastore`

Introduced in R2017b

semanticseg

Semantic image segmentation using deep learning

Syntax

```
C = semanticseg(I, network)
[C, score, allScores] = semanticseg(I, network)
[ ___ ] = semanticseg(I, network, roi)

pxds = semanticseg(ds, network)

[ ___ ] = semanticseg( ___, Name, Value)
```

Description

`C = semanticseg(I, network)` returns a semantic segmentation of the input image using deep learning.

`[C, score, allScores] = semanticseg(I, network)` also returns the classification scores for each categorical label in `C`. The function returns the scores in an array that corresponds to each pixel or voxel in the input image.

`[___] = semanticseg(I, network, roi)` returns a semantic segmentation for a rectangular subregion of the input image.

`pxds = semanticseg(ds, network)` returns the semantic segmentation for a collection of images in `ds`, a datastore object.

The function supports parallel computing using multiple MATLAB workers. You can enable parallel computing using the “Computer Vision Toolbox Preferences” dialog.

`[___] = semanticseg(___, Name, Value)` returns semantic segmentation with additional options specified by one or more name-value pair arguments.

Examples

Semantic Image Segmentation

Overlay segmentation results on an image and display the results.

Load a pretrained network.

```
data = load('triangleSegmentationNetwork');
net = data.net
```

```
net =
  SeriesNetwork with properties:
    Layers: [10x1 nnet.cnn.layer.Layer]
    InputNames: {'imageinput'}
```

```
OutputNames: {'classoutput'}
```

List the network layers.

```
net.Layers
```

```
ans =
  10x1 Layer array with layers:

   1  'imageinput'      Image Input      32x32x1 images with 'zerocenter' normaliz
   2  'conv_1'          Convolution      64 3x3x1 convolutions with stride [1 1]
   3  'relu_1'          ReLU             ReLU
   4  'maxpool'         Max Pooling      2x2 max pooling with stride [2 2] and
   5  'conv_2'          Convolution      64 3x3x64 convolutions with stride [1 1]
   6  'relu_2'          ReLU             ReLU
   7  'transposed-conv' Transposed Convolution 64 4x4x64 transposed convolutions with
   8  'conv_3'          Convolution      2 1x1x64 convolutions with stride [1 1]
   9  'softmax'         Softmax          softmax
  10  'classoutput'    Pixel Classification Layer  Class weighted cross-entropy loss with
```

Read and display the test image.

```
I = imread('triangleTest.jpg');
figure
imshow(I)
```

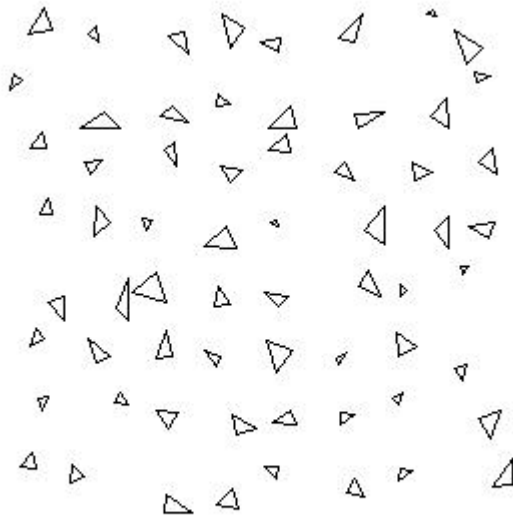

Perform semantic image segmentation.

```
[C,scores] = semanticseg(I,net,'MiniBatchSize',32);
```

Overlay segmentation results on the image and display the results.

```
B = labeloverlay(I, C);  
figure  
imshow(B)
```

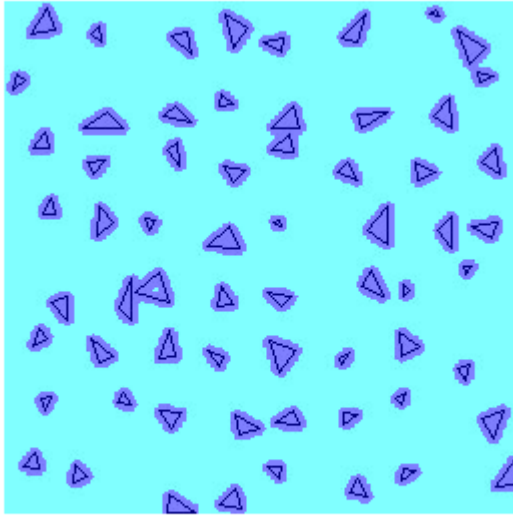

Display the classification scores.

```
figure  
imagesc(scores)  
axis square  
colorbar
```

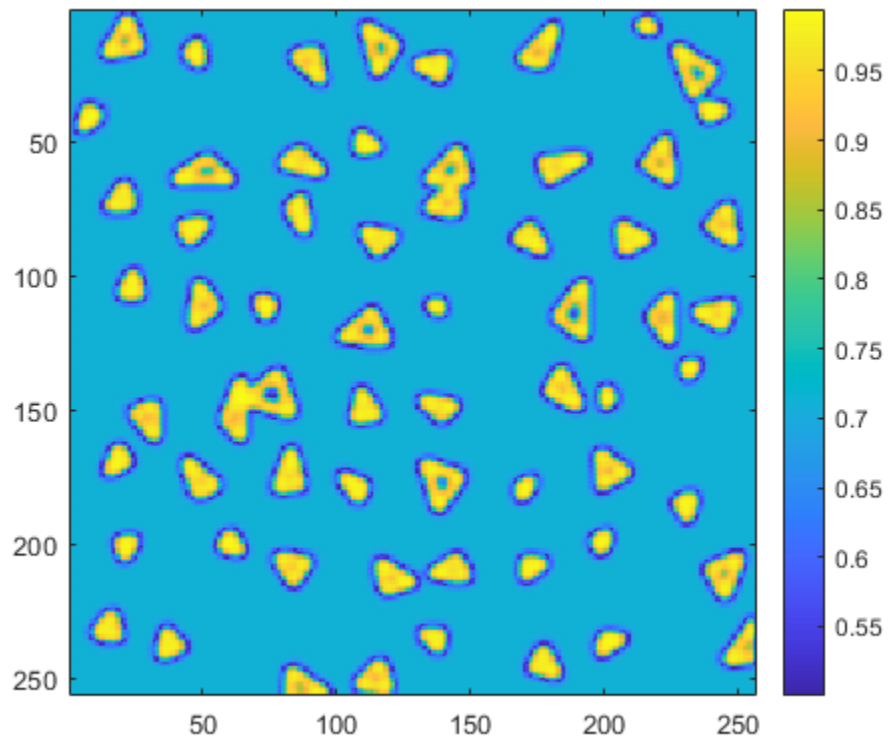

Create a binary mask with only the triangles.

```
BW = C == 'triangle';  
figure  
imshow(BW)
```

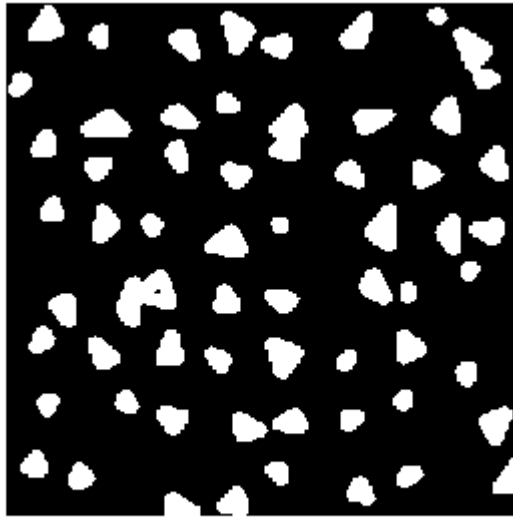

Evaluate Semantic Segmentation Test Set

Run semantic segmentation on a test set of images and compare the results against ground truth data.

Load a pretrained network.

```
data = load('triangleSegmentationNetwork');
net = data.net;
```

Load test images using `imageDatastore`.

```
dataDir = fullfile(toolboxdir('vision'),'visiondata','triangleImages');
testImageDir = fullfile(dataDir,'testImages');
imds = imageDatastore(testImageDir)
```

```
imds =
```

```
  ImageDatastore with properties:
```

```
      Files: {
          '...\toolbox\vision\visiondata\triangleImages\testImages\image_001.png'
          '...\toolbox\vision\visiondata\triangleImages\testImages\image_002.png'
          '...\toolbox\vision\visiondata\triangleImages\testImages\image_003.png'
          ... and 97 more
      }
      Folders: {
          'B:\matlab\toolbox\vision\visiondata\triangleImages\testImages'
      }
  AlternateFileSystemRoots: {}
      ReadSize: 1
      Labels: {}
  SupportedOutputFormats: ["png"    "jpg"    "jpeg"    "tif"    "tiff"]
```

```
DefaultOutputFormat: "png"
ReadFcn: @readDatastoreImage
```

Load ground truth test labels.

```
testLabelDir = fullfile(dataDir,'testLabels');
classNames = ["triangle" "background"];
pixelLabelID = [255 0];
pxdsTruth = pixelLabelDatastore(testLabelDir,classNames,pixelLabelID);
```

Run semantic segmentation on all of the test images with a batch size of 4. You can increase the batch size to increase throughput based on your systems memory resources.

```
pxdsResults = semanticseg(imds,net,'MiniBatchSize',4,'WriteLocation',tempdir);
```

```
Running semantic segmentation network
```

```
-----
```

```
* Processed 100 images.
```

Compare the results against the ground truth.

```
metrics = evaluateSemanticSegmentation(pxdsResults,pxdsTruth)
```

```
Evaluating semantic segmentation results
```

```
-----
```

```
* Selected metrics: global accuracy, class accuracy, IoU, weighted IoU, BF score.
```

```
* Processed 100 images.
```

```
* Finalizing... Done.
```

```
* Data set metrics:
```

GlobalAccuracy	MeanAccuracy	MeanIoU	WeightedIoU	MeanBFScore
0.90624	0.95085	0.61588	0.87529	0.40652

```
metrics =
  semanticSegmentationMetrics with properties:
```

```
    ConfusionMatrix: [2x2 table]
  NormalizedConfusionMatrix: [2x2 table]
      DataSetMetrics: [1x5 table]
      ClassMetrics: [2x3 table]
      ImageMetrics: [100x5 table]
```

Define Custom Pixel Classification Layer with Tversky Loss

This example shows how to define and create a custom pixel classification layer that uses Tversky loss.

This layer can be used to train semantic segmentation networks. To learn more about creating custom deep learning layers, see “Define Custom Deep Learning Layers” (Deep Learning Toolbox).

Tversky Loss

The Tversky loss is based on the Tversky index for measuring overlap between two segmented images [1 on page 3-0]. The Tversky index TI_c between one image Y and the corresponding ground truth T is given by

$$TI_c = \frac{\sum_{m=1}^M Y_{cm} T_{cm}}{\sum_{m=1}^M Y_{cm} T_{cm} + \alpha \sum_{m=1}^M Y_{cm} T_{\bar{c}m} + \beta \sum_{m=1}^M Y_{\bar{c}m} T_{cm}}$$

- c corresponds to the class and \bar{c} corresponds to not being in class c .
- M is the number of elements along the first two dimensions of Y .
- α and β are weighting factors that control the contribution that false positives and false negatives for each class make to the loss.

The loss L over the number of classes C is given by

$$L = \sum_{c=1}^C 1 - TI_c$$

Classification Layer Template

Copy the classification layer template into a new file in MATLAB®. This template outlines the structure of a classification layer and includes the functions that define the layer behavior. The rest of the example shows how to complete the `tverskyPixelClassificationLayer`.

```
classdef tverskyPixelClassificationLayer < nnet.layer.ClassificationLayer

    properties
        % Optional properties
    end

    methods

        function loss = forwardLoss(layer, Y, T)
            % Layer forward loss function goes here
        end

    end
end
```

Declare Layer Properties

By default, custom output layers have the following properties:

- **Name** - Layer name, specified as a character vector or a string scalar. To include this layer in a layer graph, you must specify a nonempty unique layer name. If you train a series network with this layer and `Name` is set to `''`, then the software automatically assigns a name at training time.
- **Description** - One-line description of the layer, specified as a character vector or a string scalar. This description appears when the layer is displayed in a `Layer` array. If you do not specify a layer description, then the software displays the layer class name.
- **Type** - Type of the layer, specified as a character vector or a string scalar. The value of `Type` appears when the layer is displayed in a `Layer` array. If you do not specify a layer type, then the software displays 'Classification layer' or 'Regression layer'.

Custom classification layers also have the following property:

- **Classes** - Classes of the output layer, specified as a categorical vector, string array, cell array of character vectors, or 'auto'. If **Classes** is 'auto', then the software automatically sets the classes at training time. If you specify a string array or cell array of character vectors **str**, then the software sets the classes of the output layer to `categorical(str, str)`. The default value is 'auto'.

If the layer has no other properties, then you can omit the **properties** section.

The Tversky loss requires a small constant value to prevent division by zero. Specify the property, **Epsilon**, to hold this value. It also requires two variable properties **Alpha** and **Beta** that control the weighting of false positives and false negatives, respectively.

```
classdef tverskyPixelClassificationLayer < nnet.layer.ClassificationLayer

    properties(Constant)
        % Small constant to prevent division by zero.
        Epsilon = 1e-8;
    end

    properties
        % Default weighting coefficients for false positives and false negatives
        Alpha = 0.5;
        Beta = 0.5;
    end

    ...
end
```

Create Constructor Function

Create the function that constructs the layer and initializes the layer properties. Specify any variables required to create the layer as inputs to the constructor function.

Specify an optional input argument name to assign to the **Name** property at creation.

```
function layer = tverskyPixelClassificationLayer(name, alpha, beta)
    % layer = tverskyPixelClassificationLayer(name) creates a Tversky
    % pixel classification layer with the specified name.

    % Set layer name
    layer.Name = name;

    % Set layer properties
    layer.Alpha = alpha;
    layer.Beta = beta;

    % Set layer description
    layer.Description = 'Tversky loss';
end
```

Create Forward Loss Function

Create a function named **forwardLoss** that returns the weighted cross entropy loss between the predictions made by the network and the training targets. The syntax for **forwardLoss** is `loss = forwardLoss(layer, Y, T)`, where **Y** is the output of the previous layer and **T** represents the training targets.

For semantic segmentation problems, the dimensions of T match the dimension of Y , where Y is a 4-D array of size H-by-W-by-K-by-N, where K is the number of classes, and N is the mini-batch size.

The size of Y depends on the output of the previous layer. To ensure that Y is the same size as T , you must include a layer that outputs the correct size before the output layer. For example, to ensure that Y is a 4-D array of prediction scores for K classes, you can include a fully connected layer of size K or a convolutional layer with K filters followed by a softmax layer before the output layer.

```
function loss = forwardLoss(layer, Y, T)
    % loss = forwardLoss(layer, Y, T) returns the Tversky loss between
    % the predictions Y and the training targets T.

    Pcnot = 1-Y;
    Gcnot = 1-T;
    TP = sum(sum(Y.*T,1),2);
    FP = sum(sum(Y.*Gcnot,1),2);
    FN = sum(sum(Pcnot.*T,1),2);

    numer = TP + layer.Epsilon;
    denom = TP + layer.Alpha*FP + layer.Beta*FN + layer.Epsilon;

    % Compute Tversky index
    lossTic = 1 - numer./denom;
    lossTI = sum(lossTic,3);

    % Return average Tversky index loss
    N = size(Y,4);
    loss = sum(lossTI)/N;

end
```

Backward Loss Function

As the `forwardLoss` function fully supports automatic differentiation, there is no need to create a function for the backward loss.

For a list of functions that support automatic differentiation, see “List of Functions with dlarray Support” (Deep Learning Toolbox).

Completed Layer

The completed layer is provided in `tverskyPixelClassificationLayer.m`.

```
classdef tverskyPixelClassificationLayer < nnet.layer.ClassificationLayer
    % This layer implements the Tversky loss function for training
    % semantic segmentation networks.

    % References
    % Salehi, Seyed Sadegh Mohseni, Deniz Erdogmus, and Ali Gholipour.
    % "Tversky loss function for image segmentation using 3D fully
    % convolutional deep networks." International Workshop on Machine
    % Learning in Medical Imaging. Springer, Cham, 2017.
    % -----

    properties(Constant)
        % Small constant to prevent division by zero.
        Epsilon = 1e-8;
    end
end
```

```

end

properties
    % Default weighting coefficients for False Positives and False
    % Negatives
    Alpha = 0.5;
    Beta = 0.5;
end

methods

function layer = tverskyPixelClassificationLayer(name, alpha, beta)
    % layer = tverskyPixelClassificationLayer(name, alpha, beta) creates a Tversky
    % pixel classification layer with the specified name and properties alpha and beta.

    % Set layer name.
    layer.Name = name;

    layer.Alpha = alpha;
    layer.Beta = beta;

    % Set layer description.
    layer.Description = 'Tversky loss';
end

function loss = forwardLoss(layer, Y, T)
    % loss = forwardLoss(layer, Y, T) returns the Tversky loss between
    % the predictions Y and the training targets T.

    Pcnnot = 1-Y;
    Gcnnot = 1-T;
    TP = sum(sum(Y.*T,1),2);
    FP = sum(sum(Y.*Gcnnot,1),2);
    FN = sum(sum(Pcnnot.*T,1),2);

    numer = TP + layer.Epsilon;
    denom = TP + layer.Alpha*FP + layer.Beta*FN + layer.Epsilon;

    % Compute tversky index
    lossTic = 1 - numer./denom;
    lossTI = sum(lossTic,3);

    % Return average tversky index loss.
    N = size(Y,4);
    loss = sum(lossTI)/N;
end
end
end

```

GPU Compatibility

The MATLAB functions used in `forwardLoss` in `tverskyPixelClassificationLayer` all support `gpuArray` inputs, so the layer is GPU compatible.

Check Output Layer Validity

Create an instance of the layer.

```
layer = tverskyPixelClassificationLayer('tversky',0.7,0.3);
```

Check the validity of the layer by using `checkLayer` (Deep Learning Toolbox). Specify the valid input size to be the size of a single observation of typical input to the layer. The layer expects a H-by-W-by-K-by-N array inputs, where K is the number of classes, and N is the number of observations in the mini-batch.

```
numClasses = 2;
validInputSize = [4 4 numClasses];
checkLayer(layer,validInputSize, 'ObservationDimension',4)
```

```
Skipping GPU tests. No compatible GPU device found.
```

```
Skipping code generation compatibility tests. To check validity of the layer for code generation
```

```
Running nnet.checklayer.TestOutputLayerWithoutBackward
```

```
.....
```

```
Done nnet.checklayer.TestOutputLayerWithoutBackward
```

```
-----
Test Summary:
```

```
8 Passed, 0 Failed, 0 Incomplete, 2 Skipped.
```

```
Time elapsed: 1.7623 seconds.
```

The test summary reports the number of passed, failed, incomplete, and skipped tests.

Use Custom Layer in Semantic Segmentation Network

Create a semantic segmentation network that uses the `tverskyPixelClassificationLayer`.

```
layers = [
    imageInputLayer([32 32 1])
    convolution2dLayer(3,64,'Padding',1)
    batchNormalizationLayer
    reluLayer
    maxPooling2dLayer(2,'Stride',2)
    convolution2dLayer(3,64,'Padding',1)
    reluLayer
    transposedConv2dLayer(4,64,'Stride',2,'Cropping',1)
    convolution2dLayer(1,2)
    softmaxLayer
    tverskyPixelClassificationLayer('tversky',0.3,0.7)];
```

Load training data for semantic segmentation using `imageDatastore` and `pixelLabelDatastore`.

```
dataSetDir = fullfile(toolboxdir('vision'),'visiondata','triangleImages');
imageDir = fullfile(dataSetDir,'trainingImages');
labelDir = fullfile(dataSetDir,'trainingLabels');

imds = imageDatastore(imageDir);

classNames = ["triangle" "background"];
labelIDs = [255 0];
pxds = pixelLabelDatastore(labelDir, classNames, labelIDs);
```

Associate the image and pixel label data by using `datastore combine`.

```
ds = combine(imds,pxds);
```

Set the training options and train the network.

```
options = trainingOptions('adam', ...
    'InitialLearnRate',1e-3, ...
    'MaxEpochs',100, ...
    'LearnRateDropFactor',5e-1, ...
    'LearnRateDropPeriod',20, ...
    'LearnRateSchedule','piecewise', ...
    'MiniBatchSize',50);
```

```
net = trainNetwork(ds, layers, options);
```

Training on single CPU.

Initializing input data normalization.

Epoch	Iteration	Time Elapsed (hh:mm:ss)	Mini-batch Accuracy	Mini-batch Loss	Base Learning Rate
1	1	00:00:01	50.32%	1.2933	0.0010
13	50	00:00:16	98.82%	0.0985	0.0010
25	100	00:00:32	99.32%	0.0545	0.0005
38	150	00:00:52	99.37%	0.0472	0.0005
50	200	00:01:11	99.48%	0.0401	0.0003
63	250	00:01:31	99.48%	0.0379	0.0001
75	300	00:01:51	99.54%	0.0348	0.0001
88	350	00:02:10	99.51%	0.0351	6.2500e-05
100	400	00:02:29	99.56%	0.0330	6.2500e-05

Training finished: Max epochs completed.

Evaluate the trained network by segmenting a test image and displaying the segmentation result.

```
I = imread('triangleTest.jpg');
[C,scores] = semanticseg(I,net);
```

```
B = labeloverlay(I,C);
montage({I,B})
```

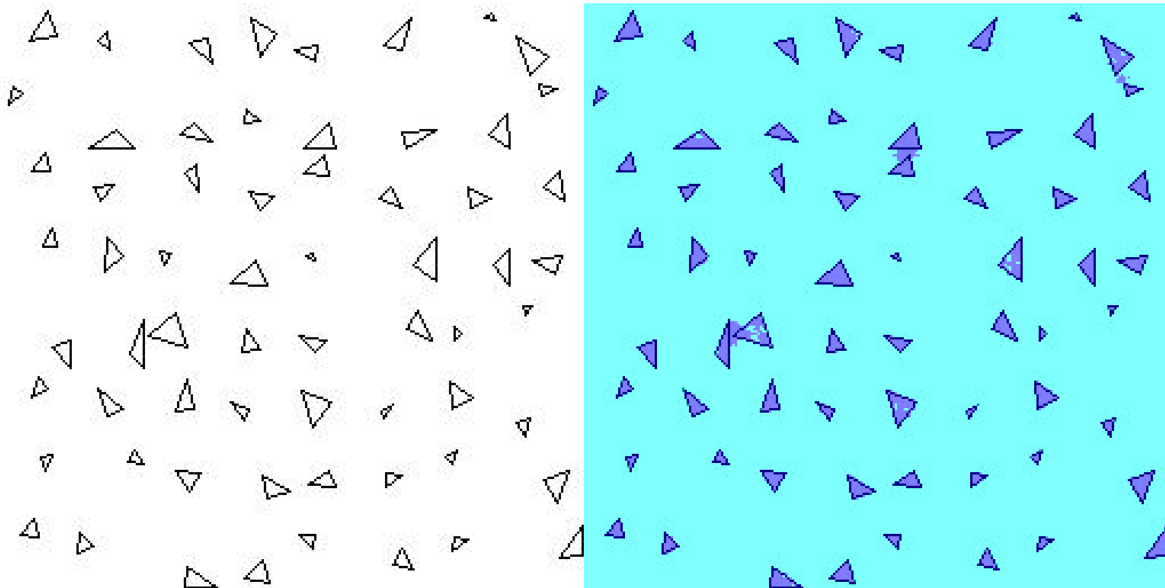

References

[1] Salehi, Seyed Sadegh Mohseni, Deniz Erdogmus, and Ali Gholipour. "Tversky loss function for image segmentation using 3D fully convolutional deep networks." *International Workshop on Machine Learning in Medical Imaging*. Springer, Cham, 2017.

Semantic Segmentation Using Dilated Convolutions

Train a semantic segmentation network using dilated convolutions.

A semantic segmentation network classifies every pixel in an image, resulting in an image that is segmented by class. Applications for semantic segmentation include road segmentation for autonomous driving and cancer cell segmentation for medical diagnosis. To learn more, see "Getting Started with Semantic Segmentation Using Deep Learning".

Semantic segmentation networks like DeepLab [1] make extensive use of dilated convolutions (also known as atrous convolutions) because they can increase the receptive field of the layer (the area of the input which the layers can see) without increasing the number of parameters or computations.

Load Training Data

The example uses a simple dataset of 32-by-32 triangle images for illustration purposes. The dataset includes accompanying pixel label ground truth data. Load the training data using an `imageDatastore` and a `pixelLabelDatastore`.

```
dataFolder = fullfile(toolboxdir('vision'),'visiondata','triangleImages');  
imageFolderTrain = fullfile(dataFolder,'trainingImages');  
labelFolderTrain = fullfile(dataFolder,'trainingLabels');
```

Create an `imageDatastore` for the images.

```
imdsTrain = imageDatastore(imageFolderTrain);
```

Create a `pixelLabelDatastore` for the ground truth pixel labels.

```
classNames = ["triangle" "background"];
labels = [255 0];
pxdsTrain = pixelLabelDatastore(labelFolderTrain,classNames,labels)
```

```
pxdsTrain =
  PixelLabelDatastore with properties:
        Files: {200x1 cell}
   ClassNames: {2x1 cell}
      ReadSize: 1
      ReadFcn: @readDatastoreImage
AlternateFileSystemRoots: {}
```

Create Semantic Segmentation Network

This example uses a simple semantic segmentation network based on dilated convolutions.

Create a data source for training data and get the pixel counts for each label.

```
ds = combine(imdsTrain,pxdsTrain);
tbl = countEachLabel(pxdsTrain)
```

```
tbl=2x3 table
      Name          PixelCount  ImagePixelCount
-----
{'triangle' }      10326         2.048e+05
{'background'}  1.9447e+05    2.048e+05
```

The majority of pixel labels are for background. This class imbalance biases the learning process in favor of the dominant class. To fix this, use class weighting to balance the classes. You can use several methods to compute class weights. One common method is inverse frequency weighting where the class weights are the inverse of the class frequencies. This method increases the weight given to under represented classes. Calculate the class weights using inverse frequency weighting.

```
numberPixels = sum(tbl.PixelCount);
frequency = tbl.PixelCount / numberPixels;
classWeights = 1 ./ frequency;
```

Create a network for pixel classification by using an image input layer with an input size corresponding to the size of the input images. Next, specify three blocks of convolution, batch normalization, and ReLU layers. For each convolutional layer, specify 32 3-by-3 filters with increasing dilation factors and pad the inputs so they are the same size as the outputs by setting the 'Padding' option to 'same'. To classify the pixels, include a convolutional layer with K 1-by-1 convolutions, where K is the number of classes, followed by a softmax layer and a `pixelClassificationLayer` with the inverse class weights.

```
inputSize = [32 32 1];
filterSize = 3;
numFilters = 32;
numClasses = numel(classNames);
```

```

layers = [
    imageInputLayer(inputSize)

    convolution2dLayer(filterSize,numFilters,'DilationFactor',1,'Padding','same')
    batchNormalizationLayer
    reluLayer

    convolution2dLayer(filterSize,numFilters,'DilationFactor',2,'Padding','same')
    batchNormalizationLayer
    reluLayer

    convolution2dLayer(filterSize,numFilters,'DilationFactor',4,'Padding','same')
    batchNormalizationLayer
    reluLayer

    convolution2dLayer(1,numClasses)
    softmaxLayer
    pixelClassificationLayer('Classes',classNames,'ClassWeights',classWeights)];

```

Train Network

Specify the training options.

```

options = trainingOptions('sgdm', ...
    'MaxEpochs', 100, ...
    'MiniBatchSize', 64, ...
    'InitialLearnRate', 1e-3);

```

Train the network using `trainNetwork`.

```
net = trainNetwork(ds,layers,options);
```

Training on single CPU.
Initializing input data normalization.

Epoch	Iteration	Time Elapsed (hh:mm:ss)	Mini-batch Accuracy	Mini-batch Loss	Base Learning Rate
1	1	00:00:01	91.62%	1.6825	0.0010
17	50	00:00:25	88.56%	0.2393	0.0010
34	100	00:00:49	92.08%	0.1672	0.0010
50	150	00:01:14	93.17%	0.1472	0.0010
67	200	00:01:42	94.15%	0.1313	0.0010
84	250	00:02:14	94.47%	0.1167	0.0010
100	300	00:02:38	95.04%	0.1100	0.0010

Training finished: Max epochs completed.

Test Network

Load the test data. Create an `imageDatastore` for the images. Create a `pixelLabelDatastore` for the ground truth pixel labels.

```

imageFolderTest = fullfile(dataFolder,'testImages');
imdsTest = imageDatastore(imageFolderTest);
labelFolderTest = fullfile(dataFolder,'testLabels');
pxdsTest = pixelLabelDatastore(labelFolderTest,classNames,labels);

```

Make predictions using the test data and trained network.

```
pxdsPred = semanticseg(imdsTest,net,'MiniBatchSize',32,'WriteLocation',tempdir);
```

```
Running semantic segmentation network
```

```
-----
```

```
* Processed 100 images.
```

Evaluate the prediction accuracy using `evaluateSemanticSegmentation`.

```
metrics = evaluateSemanticSegmentation(pxdsPred,pxdsTest);
```

```
Evaluating semantic segmentation results
```

```
-----
```

```
* Selected metrics: global accuracy, class accuracy, IoU, weighted IoU, BF score.
```

```
* Processed 100 images.
```

```
* Finalizing... Done.
```

```
* Data set metrics:
```

GlobalAccuracy	MeanAccuracy	MeanIoU	WeightedIoU	MeanBFScore
0.95237	0.97352	0.72081	0.92889	0.46416

For more information on evaluating semantic segmentation networks, see `evaluateSemanticSegmentation`.

Segment New Image

Read and display the test image `triangleTest.jpg`.

```
imgTest = imread('triangleTest.jpg');
```

```
figure
```

```
imshow(imgTest)
```

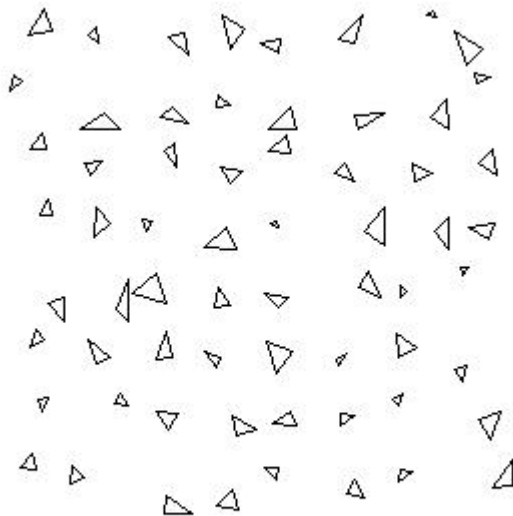

Segment the test image using `semanticseg` and display the results using `labeloverlay`.

```
C = semanticseg(imgTest,net);
B = labeloverlay(imgTest,C);
figure
imshow(B)
```

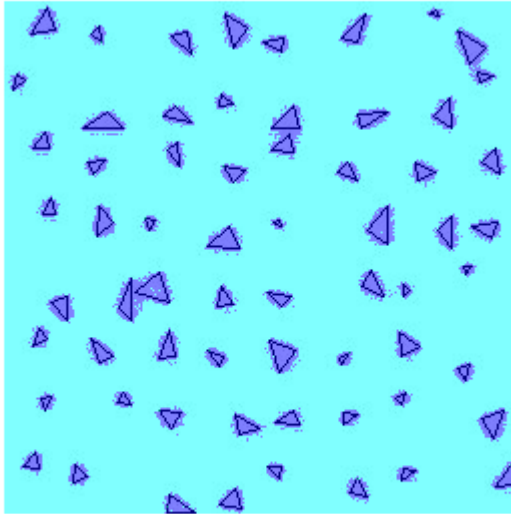

Input Arguments

I — Input image

numeric array

Input image, specified as one of the following.

Image Type	Data Format
Single 2-D grayscale image	2-D matrix of size H -by- W
Single 2-D color image or 2-D multispectral image	3-D array of size H -by- W -by- C . The number of color channels C is 3 for color images.
Series of P 2-D images	4-D array of size H -by- W -by- C -by- P . The number of color channels C is 1 for grayscale images and 3 for color images.
Single 3-D grayscale image with depth D	3-D array of size H -by- W -by- D
Single 3-D color image or 3-D multispectral image	4-D array of size H -by- W -by- D -by- C . The number of color channels C is 3 for color images.
Series of P 3-D images	5-D array of size H -by- W -by- D -by- C -by- P

The input image can also be a `gpuArray` containing one of the preceding image types (requires Parallel Computing Toolbox).

Data Types: `uint8` | `uint16` | `int16` | `double` | `single` | `logical`

network — Network

SeriesNetwork object | DAGNetwork object | dlnetwork object

Network, specified as a SeriesNetwork, DAGNetwork, or dlnetwork object.

roi — Region of interest

4-element numeric vector | 6-element vector

Region of interest, specified as one of the following.

Image Type	ROI Format
2-D image	4-element vector of the form $[x,y,width,height]$
3-D image	6-element vector of the form $[x,y,z,width,height,depth]$

The vector defines a rectangular or cuboidal region of interest fully contained in the input image. Image pixels outside the region of interest are assigned the <undefined> categorical label. If the input image consists of a series of images, then semanticseg applies the same roi to all images in the series.

ds — Collection of images

datastore object

Collection of images, specified as a datastore. The read function of the datastore must return a numeric array, cell array, or table. For cell arrays or tables with multiple columns, the function processes only the first column.

For more information, see “Datastores for Deep Learning” (Deep Learning Toolbox).

Name-Value Pair Arguments

Specify optional comma-separated pairs of Name, Value arguments. Name is the argument name and Value is the corresponding value. Name must appear inside quotes. You can specify several name and value pair arguments in any order as Name1, Value1, . . . , NameN, ValueN.

Example: 'ExecutionEnvironment', 'gpu'

OutputType — Returned segmentation type

'categorical' (default) | 'double' | 'uint8'

Returned segmentation type, specified as 'categorical', 'double', or 'uint8'. When you specify 'double' or 'uint8', the function returns the segmentation results as a label array containing label IDs. The IDs are integer values that correspond to the class names defined in the classification layer used in the input network.

You cannot use the OutputType property with an ImageDatastore object input.

MiniBatchSize — Group of images

128 (default) | integer

Group of images, specified as an integer. Images are grouped and processed together as a batch. Batches are used for processing a large collection of images and they improve computational efficiency. Increasing the 'MiniBatchSize' value increases the efficiency, but it also takes up more memory.

ExecutionEnvironment — Hardware resource

'auto' (default) | 'gpu' | 'cpu'

Hardware resource for processing images with a network, specified as 'auto', 'gpu', or 'cpu'.

ExecutionEnvironment	Description
'auto'	Use a GPU if available. Otherwise, use the CPU. The use of GPU requires Parallel Computing Toolbox and a CUDA enabled NVIDIA GPU. For information about the supported compute capabilities, see “GPU Support by Release” (Parallel Computing Toolbox).
'gpu'	Use the GPU. If a suitable GPU is not available, the function returns an error message.
'cpu'	Use the CPU.

Acceleration — Performance optimization

'auto' (default) | 'mex' | 'none'

Performance optimization, specified as 'auto', 'mex', or 'none'.

Acceleration	Description
'auto'	Automatically apply a number of optimizations suitable for the input network and hardware resource.
'mex'	Compile and execute a MEX function. This option is available when using a GPU only. You must also have a C/C++ compiler installed. For setup instructions, see “MEX Setup” (GPU Coder).
'none'	Disable all acceleration.

The default option is 'auto'. If you use the 'auto' option, then MATLAB does not ever generate a MEX function.

Using the 'Acceleration' options 'auto' and 'mex' can offer performance benefits, but at the expense of an increased initial run time. Subsequent calls with compatible parameters are faster. Use performance optimization when you plan to call the function multiple times using new input data.

The 'mex' option generates and executes a MEX function based on the network and parameters used in the function call. You can have several MEX functions associated with a single network at one time. Clearing the network variable also clears any MEX functions associated with that network.

The 'mex' option is only available when you are using a GPU. Using a GPU requires Parallel Computing Toolbox and a CUDA enabled NVIDIA GPU. For information about the supported compute capabilities, see “GPU Support by Release” (Parallel Computing Toolbox). If Parallel Computing Toolbox or a suitable GPU is not available, then the function returns an error.

'mex' acceleration does not support all layers. For a list of supported layers, see “Supported Layers” (GPU Coder).

Classes — Classes into which pixels or voxels are classified

'auto' (default) | cell array of character vectors | string vector | categorical vector

Classes into which pixels or voxels are classified, specified as 'auto', a cell array of character vectors, a string vector, or a categorical vector. If the value is a categorical vector Y , then the elements of the vector are sorted and ordered according to `categories(Y)`.

If the network is a `dlnetwork` object, then the number of classes specified by 'Classes' must match the number of channels in the output of the network predictions. By default, when 'Classes' has the value 'auto', the classes are numbered from 1 through C , where C is the number of channels in the output layer of the network.

If the network is a `SeriesNetwork` or `DAGNetwork` object, then the number of classes specified by 'Classes' must match the number of classes in the classification output layer. By default, when 'Classes' has the value 'auto', the classes are automatically set using the classification output layer.

WriteLocation – Folder location

`pwd` (current working folder) (default) | string scalar | character vector

Folder location, specified as `pwd` (your current working folder), a string scalar, or a character vector. The specified folder must exist and have write permissions.

This property applies only when using an `ImageDatastore` object input.

NamePrefix – Prefix applied to output file names

'pixelLabel' (default) | string scalar | character vector

Prefix applied to output file names, specified as a string scalar or character vector. The image files are named as follows:

- `prefix_N.png`, where N corresponds to the index of the input image file, `imds.Files(N)`.

This property applies only when using an `ImageDatastore` object input.

Verbose – Display progress information

'true' (default) | 'false'

Display progress information, specified as 'true' or 'false'.

This property applies only when using an `ImageDatastore` object input.

Output Arguments

C – Categorical labels

categorical array

Categorical labels, returned as a categorical array. The categorical array relates a label to each pixel or voxel in the input image. The images returned by `readall(datastore)` have a one-to-one correspondence with the categorical matrices returned by `readall(pixelLabelDatastore)`. The elements of the label array correspond to the pixel or voxel elements of the input image. If you select an ROI, then the labels are limited to the area within the ROI. Image pixels and voxels outside the region of interest are assigned the `<undefined>` categorical label.

Image Type	Categorical Label Format
Single 2-D image	2-D matrix of size H -by- W . Element $C(i,j)$ is the categorical label assigned to the pixel $I(i,j)$.
Series of P 2-D images	3-D array of size H -by- W -by- P . Element $C(i,j,p)$ is the categorical label assigned to the pixel $I(i,j,p)$.
Single 3-D image	3-D array of size H -by- W -by- D . Element $C(i,j,k)$ is the categorical label assigned to the voxel $I(i,j,k)$.
Series of P 3-D images	4-D array of size H -by- W -by- D -by- P . Element $C(i,j,k,p)$ is the categorical label assigned to the voxel $I(i,j,k,p)$.

score — Confidence scores

categorical array

Confidence scores for each categorical label in C , returned as an array of values between 0 and 1. The scores represents the confidence in the predicted labels C . Higher score values indicate a higher confidence in the predicted label.

Image Type	Score Format
Single 2-D image	2-D matrix of size H -by- W . Element $\text{score}(i,j)$ is the classification score of the pixel $I(i,j)$.
Series of P 2-D images	3-D array of size H -by- W -by- P . Element $\text{score}(i,j,p)$ is the classification score of the pixel $I(i,j,p)$.
Single 3-D image	3-D array of size H -by- W -by- D . Element $\text{score}(i,j,k)$ is the classification score of the voxel $I(i,j,k)$.
Series of P 3-D images	4-D array of size H -by- W -by- D -by- P . Element $\text{score}(i,j,k,p)$ is the classification score of the voxel $I(i,j,k,p)$.

allScores — Scores for all label categories

numeric array

Scores for all label categories that the input network can classify, returned as a numeric array. The format of the array is described in the following table. L represents the total number of label categories.

Image Type	All Scores Format
Single 2-D image	3-D array of size H -by- W -by- L . Element $\text{allScores}(i,j,q)$ is the score of the q th label at the pixel $I(i,j)$.
Series of P 2-D images	4-D array of size H -by- W -by- L -by- P . Element $\text{allScores}(i,j,q,p)$ is the score of the q th label at the pixel $I(i,j,p)$.
Single 3-D image	4-D array of size H -by- W -by- D -by- L . Element $\text{allScores}(i,j,k,q)$ is the score of the q th label at the voxel $I(i,j,k)$.
Series of P 3-D images	5-D array of size H -by- W -by- D -by- L -by- P . Element $\text{allScores}(i,j,k,q,p)$ is the score of the q th label at the voxel $I(i,j,k,p)$.

pxds — Semantic segmentation results

PixelLabelDatastore object

Semantic segmentation results, returned as a `pixelLabelDatastore` object. The object contains the semantic segmentation results for all the images contained in the `ds` input object. The result for each image is saved as separate `uint8` label matrices of PNG images. You can use `read(pxds)` to return the categorical labels assigned to the images in `ds`.

The images in the output of `readall(ds)` have a one-to-one correspondence with the categorical matrices in the output of `readall(pxds)`.

Extended Capabilities

Automatic Parallel Support

Accelerate code by automatically running computation in parallel using Parallel Computing Toolbox™.

To run in parallel, set `'UseParallel'` to `true` or enable this by default using the Computer Vision Toolbox preferences.

For more information, see “Parallel Computing Toolbox Support”.

See Also

Functions

`trainNetwork` | `labeloverlay` | `evaluateSemanticSegmentation`

Apps

`Image Labeler` | `Video Labeler`

Objects

`ImageDatastore` | `pixelLabelDatastore` | `dlnetwork`

Topics

“Getting Started with Semantic Segmentation Using Deep Learning”

“Deep Learning in MATLAB” (Deep Learning Toolbox)

“Datastores for Deep Learning” (Deep Learning Toolbox)

External Websites

What is Semantic Segmentation?

Introduced in R2017b

detectKAZEFeatures

Detect KAZE features and return KAZEPoints object

Syntax

```
points = detectKAZEFeatures(I)  
points = detectKAZEFeatures(I,Name,Value)
```

Description

`points = detectKAZEFeatures(I)` returns a `KAZEPoints` object containing information about KAZE keypoints detected in a 2-D grayscale image. The function uses nonlinear diffusion to construct a scale space for the given image. It then detects multiscale corner features from the scale space.

`points = detectKAZEFeatures(I,Name,Value)` returns a `KAZEPoints` object with additional options specified by one or more `Name,Value` pair arguments

Examples

Detect KAZE Feature Points in Image

Detect and plot KAZE feature points.

Read an image.

```
I = imread('cameraman.tif');
```

Detect KAZE points in the image.

```
points = detectKAZEFeatures(I);
```

Plot the 20 strongest points.

```
imshow(I)  
hold on  
plot(selectStrongest(points,20))  
hold off
```



Detect KAZE Features and Display Specific Points

Detect KAZE features and display set the specific KAZE points you want to plot.

Read an image.

```
I = imread('cameraman.tif');
```

Detect KAZE features in the image.

```
points = detectKAZEFeatures(I);
```

Select and display the last 5 points detected.

```
imshow(I);  
hold on;  
plot(points(end-4:end));  
hold off;
```



Input Arguments

I — Input image

2-D grayscale image

Input image, specified as a 2-D grayscale image.

Data Types: `single` | `double` | `int16` | `uint8` | `uint16` | `logical`

Name-Value Pair Arguments

Specify optional comma-separated pairs of `Name`, `Value` arguments. `Name` is the argument name and `Value` is the corresponding value. `Name` must appear inside quotes. You can specify several name and value pair arguments in any order as `Name1`, `Value1`, ..., `NameN`, `ValueN`.

Example: `'Diffusion','region'`

Diffusion — Method to compute conductivity

`'region'` (default) | `'sharpedge'` | `'edge'`

Method to compute conductivity, specified as `'region'`, `'sharpedge'`, or `'edge'`. The computation is based on first-order derivatives of a layer in scale space.

Method	Selected Features
<code>'region'</code>	Large regions. Uses the Perona and Malik conductivity coefficient, $1/(1 + dL^2/k^2)$.
<code>'sharpedge'</code>	High-contrast edges. Uses the Perona and Malik conductivity coefficient, $\exp(- dL ^2/k^2)$.

Method	Selected Features
'edge'	Smoothing on both sides of an edge rather than across it. Uses the Weickert conductivity coefficient.

Threshold — Local extrema

0.0001 (default) | scalar

Local extrema, specified as a scalar greater than or equal to 0. Increase this value to exclude less significant local extrema.

NumOctaves — Multiscale detection factor

3 (default) | positive integer

Multiscale detection factor, specified as a positive integer. Increase this value to detect larger features. To disable multiscale detection, set NumOctaves to 1. When you set the value to 1, the function detects the scale of the input image. Recommended values are between 1 and 4.

NumScaleLevels — Scale levels

4 (default) | integer

Scale levels, specified as an integer in the range [3,10]. Increase this value to achieve smoother scale changes. Increasing this value also provides additional intermediate scales between octaves. Recommended values are between 1 and 4.

ROI — Rectangular region size

[1 1 size(I,2) size(I,1)] (default) | 4-element vector

Rectangular region size for corner detection, specified as a 4-element vector in the format [y x width height]. The [y x] values are measured from the upper left corner of the rectangle.

Output Arguments**points — KAZE points object**

KAZEpoints object

KAZE points, returned as a KAZEPoints object. The object contains information about the feature points detected in the 2-D grayscale input image.

References

[1] Alcantarilla, P.F., A. Bartoli, and A.J. Davison. "KAZE Features." *ECCV 2012, Part VI, LNCS 7577*. 2012, p. 214

Extended Capabilities**C/C++ Code Generation**

Generate C and C++ code using MATLAB® Coder™.

Usage notes and limitations:

- Generates portable C code using a C++ compiler that links to OpenCV (Version 3.4.0) libraries. See "Portable C Code Generation for Functions That Use OpenCV Library".

See Also

Functions

[detectSURFFeatures](#) | [detectMinEigenFeatures](#) | [detectBRISKFeatures](#) | [detectFASTFeatures](#) | [detectMSERFeatures](#) | [detectORBFeatures](#) | [extractFeatures](#) | [extractHOGFeatures](#) | [detectHarrisFeatures](#) | [detectFASTFeatures](#) | [matchFeatures](#)

Objects

[MSERRegions](#) | [SURFPoints](#) | [BRISKPoints](#) | [cornerPoints](#) | [binaryFeatures](#)

Introduced in R2017b

selectUniform

Select uniformly distributed subset of feature points

Syntax

```
pointsOut = selectUniform(points,N,imageSize)
```

Description

`pointsOut = selectUniform(points,N,imageSize)` returns N uniformly distributed points from `pointsIn` points of an image of size `imageSize`.

Examples

Select Uniformly Distributed Subset of KAZE Features

Detect and plot a subset of uniformly distributed KAZE features from an image.

Read an image.

```
im = imread('yellowstone_left.png');
```

Detect and display KAZE features.

```
points1 = detectKAZEFeatures(im2gray(im))
```

```
points1 =  
    6712x1 KAZEPoints array with properties:
```

```
    Location: [6712x2 single]  
    Metric: [6712x1 single]  
    Count: 6712  
    Scale: [6712x1 single]  
    Orientation: [6712x1 single]
```

```
subplot(1,2,1)  
imshow(im)  
hold on  
plot(points1)  
hold off  
title('Original Points')
```

Select a uniformly distributed subset of points.

```
numPoints = 100;  
points2 = selectUniform(points1,numPoints,size(im))
```

```
points2 =  
    100x1 KAZEPoints array with properties:
```

```
    Location: [100x2 single]
```

```
Metric: [100x1 single]  
Count: 100  
Scale: [100x1 single]  
Orientation: [100x1 single]
```

```
subplot(1,2,2)  
imshow(im)  
hold on  
plot(points2)  
hold off  
title('Uniformly Distributed Points')
```

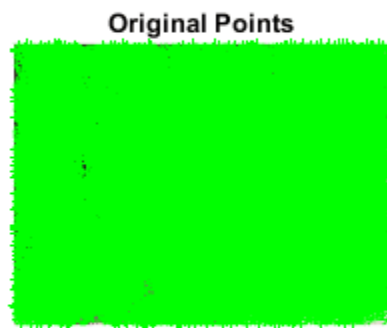

Select Uniformly Distributed Subset of Features from Image

Load an image.

```
im = imread('yellowstone_left.png');
```

Detect many corners by reducing the quality threshold.

```
points1 = detectHarrisFeatures(im2gray(im), 'MinQuality', 0.05);
```

Plot image with detected corners.

```
subplot(1,2,1);  
imshow(im);  
hold on  
plot(points1);  
hold off  
title('Original points');
```

Select a uniformly distributed subset of points.

```
numPoints = 100;  
points2 = selectUniform(points1,numPoints,size(im));
```

Plot images showing original and subset of points.

```
subplot(1, 2, 2);  
imshow(im);  
hold on  
plot(points2);  
hold off  
title('Uniformly distributed points');
```

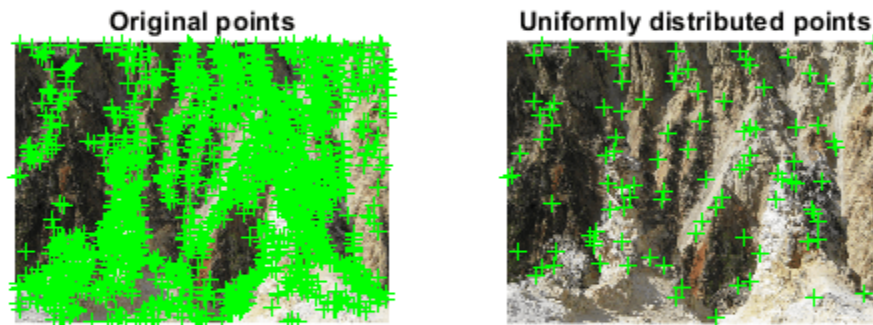

Select A Uniformly Distributed Subset of Features From an Image

Load an image into the workspace.

```
im = imread('yellowstone_left.png');
```

Detect many corners by reducing the quality threshold.

```
points1 = detectBRISKFeatures(im2gray(im), 'MinQuality', 0.05);
```

Plot image with detected corners.

```
subplot(1,2,1);  
imshow(im);  
hold on  
plot(points1);  
hold off  
title('Original points');
```

Select a uniformly distributed subset of points.

```
numPoints = 100;  
points2 = selectUniform(points1,numPoints,size(im));
```

Plot images showing original and subset of points.

```
subplot(1, 2, 2);  
imshow(im);  
hold on  
plot(points2);  
hold off  
title('Uniformly distributed points');
```

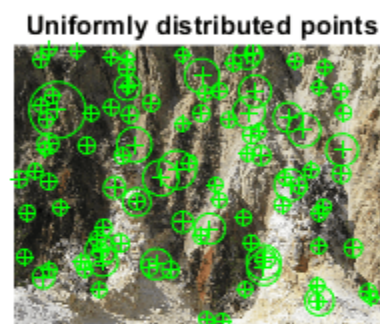
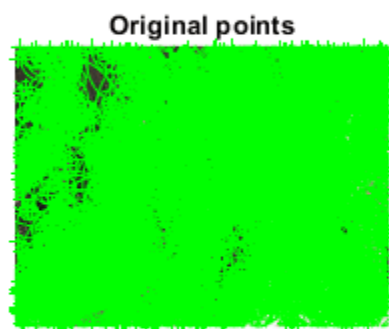

Select Uniformly Distributed Subset Features from an Image

Load an image.

```
im = imread('yellowstone_left.png');
```

Detect and display SURF features.

```
points1 = detectSURFFeatures(im2gray(im));  
subplot(1,2,1);  
imshow(im);  
hold on  
plot(points1);  
hold off  
title('Original points');
```

Select a uniformly distributed subset of points.

```
numPoints = 100;  
points2 = selectUniform(points1,numPoints,size(im));
```

Plot images showing original and subset of points.

```
subplot(1, 2, 2);  
imshow(im);  
hold on  
plot(points2);  
hold off  
title('Uniformly distributed points');
```

Original points

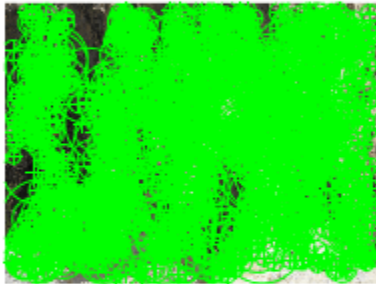

Uniformly distributed points



Input Arguments

points — Points object

KAZEPoints object | CornerPoints object | BRISKPoints object | SURFPoints object | ORBPoints object | SIFTPoints

Points object, specified as a `points` object. The object contains information about the feature points detected in the input image. To obtain points, use the appropriate detect function.

N — Number of points

integer

Number of uniformly distributed points to select, specified as an integer.

imageSize — Size of image

2-element vector | 3-element vector

Size of image, specified as a 2-element vector for grayscale images or a 3-element vector for truecolor images.

See Also

Functions

detectKAZEFeatures | detectBRISKFeatures | detectFASTFeatures | detectMinEigenFeatures | detectHarrisFeatures | detectORBFeatures | detectSIFTFeatures | extractFeatures | matchFeatures | detectSURFFeatures

Objects

MSERRegions | SURFPoints | BRISKPoints | KAZEPoints | cornerPoints | ORBPoints | SIFTPoints

Introduced in R2012a

size

Return size of points object

Syntax

```
size(points)
sz = size(points)
sz = size(points,1)
sz = size(points,dimension)
[M,N] = size(points)
```

Description

`size(points)` returns the size of the points object.

`sz = size(points)` returns the vector `[length(points), 1]`.

`sz = size(points,1)` returns the length of points.

`sz = size(points,dimension)` returns the length of the dimension.

`[M,N] = size(points)` returns `length(points)` for *M* and 1 for *N*

Examples

Find Size of Points Object

Read an image.

```
I = imread('cameraman.tif');
```

Detect corner features.

```
featurePoints = detectHarrisFeatures(I);
```

Find the size of the feature points object.

```
sz = size(featurePoints)
```

```
sz = 1×2
```

```
184    1
```

Plot feature image with detected features.

```
imshow(I); hold on;
plot(featurePoints);
```



Input Arguments

points — Points object

KAZEPoints object | CornerPoints object | BRISKPoints object | SURFPoints object | MSERRegions object | ORBPoints object | SIFTPoints object

Points object, specified as a `points` object. The object contains information about the feature points detected in the input image. To obtain points, use the appropriate detect function.

dimension — Dimension

integer

Dimension, returned as an integer. For $\text{dim} \geq 2$, the object returns 1.

See Also

binaryFeatures | MSERRegions | SURFPoints | BRISKPoints | KAZEPoints | cornerPoints | ORBPoints | SIFTPoints

Introduced in R2012a

selectStrongest

Select points with strongest metrics

Syntax

```
strongestPoints = selectStrongest(points,N)
```

Description

`strongestPoints = selectStrongest(points,N)` returns N number of points that have the strongest metrics.

Examples

Select Strongest KAZE Features

Create a KAZEPoints object holding 50 points.

```
points = KAZEPoints(ones(50,2), 'Metric', 1:50);
```

Keep the two strongest features.

```
points = selectStrongest(points,2)
```

```
points =  
    2x1 KAZEPoints array with properties:
```

```
    Location: [2x2 single]  
    Metric: [2x1 single]  
    Count: 2  
    Scale: [2x1 single]  
    Orientation: [2x1 single]
```

Input Arguments

points — Points

KAZEPoints object | CornerPoints object | BRISKPoints object | SURFPoints object | ORBPoints object | SIFTPoints

Points, specified as a points object. The object contains information about the feature points detected in the 2-D grayscale input image.

N — Number of points

integer

Number of strongest points to select, specified as an integer.

See Also

[binaryFeatures](#) | [MSERRegions](#) | [SURFPoints](#) | [BRISKPoints](#) | [KAZEPoints](#) | [cornerPoints](#) | [ORBPoints](#) | [SIFTPoints](#)

Introduced in R2017b

plot

Plot points

Syntax

```
plot(points)
plot(points,ax)
plot(points,ax,Name,Value)
```

Description

`plot(points)` plots points in the current axis.

`plot(points,ax)` plots points in the specified axis.

`plot(points,ax,Name,Value)` sets properties using one or more name-value pairs. Enclose each property name in quotes. For example, `plot('ShowOrientation',true)`

Examples

Plot KAZE Points

Detect, extract, and plot KAZE points, including their orientation.

Read an image.

```
I = imread('cameraman.tif');
```

Detect KAZE points from the image.

```
points = detectKAZEFeatures(I);
```

Extract KAZE features from the detected points.

```
[features,valid_points] = extractFeatures(I,points);
```

Plot the 10 strongest points and show their orientations.

```
imshow(I)
hold on
strongestPoints = selectStrongest(valid_points,10);
plot(strongestPoints,'showOrientation',true)
hold off
```



Plot SURF features

Extract SURF features from an image.

```
I = imread('cameraman.tif');  
points = detectSURFFeatures(I);  
[features, valid_points] = extractFeatures(I,points);
```

Visualize 10 strongest SURF features, including their scales and orientation which were determined during the descriptor extraction process.

```
imshow(I);  
hold on;  
strongestPoints = valid_points.selectStrongest(10);  
strongestPoints.plot('showOrientation',true);
```

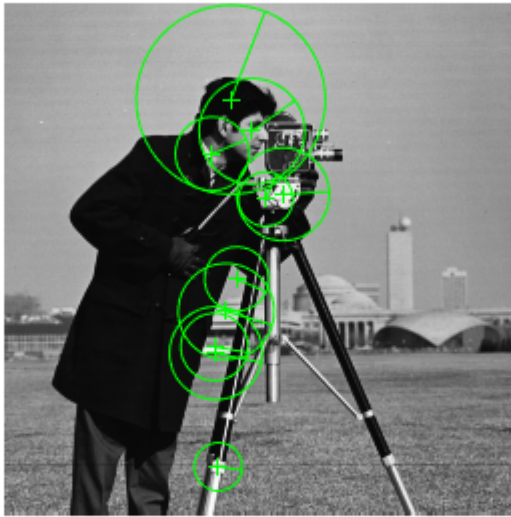

Plot Corner Features

Read an image.

```
I = imread('cameraman.tif');
```

Detect corner features.

```
featurePoints = detectHarrisFeatures(I);
```

Plot feature image with detected features.

```
imshow(I); hold on;  
plot(featurePoints);
```



Input Arguments

points — Points

KAZEPoints object | CornerPoints object | BRISKPoints object | SURFPoints object | MSERRegions object | ORBPoints object | SIFTPoints object

Points, specified as a points object. The object contains information about the feature points detected in the 2-D grayscale input image.

ax — Axes handle

handle

Handle to use for display. You can set the handle using `gca`.

Name-Value Pair Arguments

Example: `'ShowOrientation','true'`

ShowScale — Display scaled circle

true (default) | false

Display scaled circle, specified as `true` or `false`. When you set this value to `true`, the object draws a circle proportional to the scale of the detected feature, with the feature point located at its center. When you set this value to `false`, the object turns the display of the circle off.

The algorithm represents the scale of the feature with a circle of $6 \times \text{Scale}$ radius. The algorithm uses this equivalent size of circular area to compute the orientation of the feature.

ShowOrientation — Display orientation line

true (default) | false

Display feature point orientation, specified as `true` or `false`. When you set this value to `true`, the object draws a line corresponding to the point's orientation. The object draws the line from the feature point location to the edge of the circle, indicating the scale.

See Also

`binaryFeatures` | `KAZEPoints` | `MSERRegions` | `SURFPoints` | `BRISKPoints` | `KAZEPoints` | `cornerPoints` | `ORBPoints` | `SIFTPoints`

Introduced in R2011b

length

Number of stored points

Syntax

```
length(points)
```

Description

`length(points)` returns the number of stored points in the `points` object.

Examples

Check Number of Stored Points

Read an image.

```
I = imread('cameraman.tif');
```

Detect KAZE points from the image.

```
points = detectKAZEFeatures(I);
```

Find number of stored points.

```
numPoints = length(points)
```

```
numPoints = 631
```

Extract KAZE features from the detected points.

```
[features,validPoints] = extractFeatures(I,points);
```

Plot the ten strongest valid extracted points and show their orientations.

```
imshow(I)
hold on
strongestPoints = selectStrongest(validPoints,10);
plot(strongestPoints,'showOrientation',true)
hold off
```



Input Arguments

points — Points object

`KAZEPoints` object | `CornerPoints` object | `BRISKPoints` object | `SURFPoints` object | `MSERRegions` object | `ORBPoints` object | `SIFTPoints` object

Points object, specified as a `points` object. The object contains information about the feature points detected in the input image. To obtain points, use the appropriate detect function.

See Also

`detectKAZEFeatures` | `detectBRISKFeatures` | `detectMSERFeatures` | `detectFASTFeatures` | `detectMinEigenFeatures` | `detectORBFeatures` | `detectSIFTFeatures` | `detectHarrisFeatures` | `extractFeatures` | `matchFeatures` | `detectSURFFeatures` | `MSERRegions` | `SURFPoints` | `BRISKPoints` | `KAZEPoints` | `cornerPoints` | `ORBPoints` | `SIFTPoints`

Introduced in R2017b

isempty

Determine if points object is empty

Syntax

```
isempty(points)
```

Description

`isempty(points)` returns a true value, if the points object is empty.

Examples

Check if Points Object is Empty

Read an image.

```
I = imread('cameraman.tif');
```

Detect KAZE points from the image.

```
points = detectKAZEFeatures(I);
```

Check for points.

```
if isempty(points)
    return;
end
```

Extract KAZE features from the detected points.

```
[features,validPoints] = extractFeatures(I,points);
```

Plot the ten strongest valid extracted points and show their orientations.

```
imshow(I)
hold on
strongestPoints = selectStrongest(validPoints,10);
plot(strongestPoints,'showOrientation',true)
hold off
```



Input Arguments

points — Points object

`KAZEPoints` object | `CornerPoints` object | `BRISKPoints` object | `SURFPoints` object | `MSERRegions` object | `ORBPoints` object | `SIFTPoints` object

Points object, specified as a `points` object. The object contains information about the feature points detected in the input image. To obtain points, use the appropriate detect function.

See Also

`detectKAZEFeatures` | `detectBRISKFeatures` | `detectMSERFeatures` | `detectFASTFeatures` | `detectMinEigenFeatures` | `detectORBFeatures` | `detectSIFTFeatures` | `detectHarrisFeatures` | `extractFeatures` | `matchFeatures` | `detectSURFFeatures` | `MSERRegions` | `SURFPoints` | `BRISKPoints` | `KAZEPoints` | `cornerPoints` | `ORBPoints` | `SIFTPoints`

Introduced in R2017b

gather

Retrieve cornerPoints from the GPU

Syntax

```
pointsCPU = gather(pointsGPU)
```

Description

`pointsCPU = gather(pointsGPU)` returns a `cornerPoints` object with data gathered from the GPU for the `Location` and `Metric` properties.

Examples

Find and Plot Corner Points in Image

Read an image.

```
I = imread('cameraman.tif')
```

```
I = 256×256 uint8 matrix
```

```

156 159 158 155 158 156 159 158 157 158 158 159 160 160 160 158
160 154 157 158 157 159 158 158 158 160 155 156 159 158 160 157
156 159 158 155 158 156 159 158 157 158 158 159 160 160 160 158
160 154 157 158 157 159 158 158 158 160 155 156 159 158 160 157
156 153 155 159 159 155 156 155 155 157 155 154 154 158 162 157
155 155 155 157 156 159 152 158 156 158 152 153 159 156 157 161
156 153 157 156 153 155 154 155 157 156 155 156 155 157 158 160
159 159 156 158 156 159 157 161 162 157 157 159 161 156 163 158
158 155 158 154 156 160 162 155 159 161 156 161 160 155 158 161
155 154 157 158 160 160 159 160 158 161 160 160 158 161 158 160
:
```

Create a GPU array object.

```
I = gpuArray(I);
```

Find and display Harris features in the image.

```

pointsGPU = detectHarrisFeatures(I);
imshow(I);
hold on;
plot(pointsGPU.selectStrongest(50));
```



Copy the corner points to the CPU for further processing.

```
pointsCPU = gather(pointsGPU);
```

Input Arguments

pointsGPU — GPU points

points object (default)

GPU points, specified as a points object.

See Also

cornerPoints

Introduced in R2012a

plot

Plot MSER regions

Syntax

```
plot(points)
plot(points,ax)
plot(points,ax,Name,Value)
```

Description

`plot(points)` plots points in the current axis.

`plot(points,ax)` plots points in the specified axis.

`plot(points,ax,Name,Value)` sets properties using one or more name-value pairs. Enclose each property name in quotes. For example, `plot('ShowOrientation',true)`

Examples

Plot MSER Regions

Extract MSER features and plot the regions.

Read image and extract MSER features.

```
I = imread('cameraman.tif');
regions = detectMSERFeatures(I);
imshow(I); hold on;
plot(regions);
```



Plot MSER Regions.

```
figure; imshow(I); hold on;  
plot(regions,'showPixelList',true,'showEllipses',false);  
hold off;
```

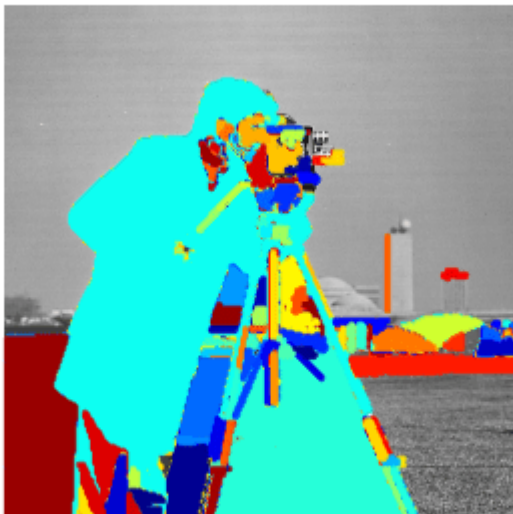

Input Arguments

points — Points

MSERRegions object

Points, specified as a points object. The object contains information about the feature points detected in the 2-D grayscale input image.

ax — Axes handle

handle

Handle to use for display. You can set the handle using `gca`.

Name-Value Pair Arguments

Example: `'ShowOrientation','true'`

showEllipses — Display ellipsis

`true` (default) | `false`

Display ellipsis around feature, specified as `true` or `false`. When you set this value to `true`, the object draws an ellipse with the same 2nd order moments as the region. When you set this value to `false`, only the ellipses centers are plotted.

ShowOrientation — Display orientation line

`true` (default) | `false`

Display feature point orientation, specified as `true` or `false`. When you set this value to `true`, the object draws a line corresponding to the point's orientation. The object draws the line from the feature point location to the edge of the circle, indicating the scale.

showPixelList — Display regions using JET colormap

`true` (default) | `false`

Display regions using JET colormap, specified as `true` or `false`.

See Also

`detectMSERFeatures`

Introduced in R2012a

assignDetectionsToTracks

Assign detections to tracks for multiobject tracking

Syntax

```
[assignments,unassignedTracks,unassignedDetections] =
assignDetectionsToTracks(costMatrix,costOfNonAssignment)
[assignments,unassignedTracks,unassignedDetections] =
assignDetectionsToTracks(costMatrix, unassignedTrackCost,
unassignedDetectionCost)
```

Description

[assignments,unassignedTracks,unassignedDetections] = assignDetectionsToTracks(costMatrix,costOfNonAssignment) assigns detections to tracks in the context of multiple object tracking using the James Munkres's variant of the Hungarian assignment algorithm. It also determines which tracks are missing and which detections should begin new tracks. It returns the indices of assigned and unassigned tracks, and unassigned detections. The costMatrix must be an M -by- N matrix. In this matrix, M represents the number of tracks, and N is the number of detections. Each value represents the cost of assigning the N^{th} detection to the M^{th} track. The lower the cost, the more likely that a detection gets assigned to a track. The costOfNonAssignment scalar input represents the cost of a track or a detection remaining unassigned.

[assignments,unassignedTracks,unassignedDetections] = assignDetectionsToTracks(costMatrix, unassignedTrackCost, unassignedDetectionCost) specifies the cost of unassigned tracks and detections separately. The unassignedTrackCost must be a scalar value, or an M -element vector, where M represents the number of tracks. For the M -element vector, each element represents the cost of not assigning any detection to that track. The unassignedDetectionCost must be a scalar value or an N -element vector, where N represents the number of detections.

Examples

Assign Detections to Tracks in a Single Video Frame

This example shows you how to assign a detection to a track for a single video frame.

Set the predicted locations of objects in the current frame. Obtain predictions using the Kalman filter System object.

```
predictions = [1,1;2,2];
```

Set the locations of the objects detected in the current frame. For this example, there are 2 tracks and 3 new detections. Thus, at least one of the detections is unmatched, which can indicate a new track.

```
detections = [1.1,1.1;2.1,2.1;1.5,3];
```

Preallocate a cost matrix.

```
cost = zeros(size(predictions,1),size(detections,1));
```

Compute the cost of each prediction matching a detection. The cost here, is defined as the Euclidean distance between the prediction and the detection.

```
for i = 1:size(predictions, 1)
    diff = detections - repmat(predictions(i,:),[size(detections,1),1]);
    cost(i, :) = sqrt(sum(diff.^2,2));
end
```

Associate detections with predictions. Detection 1 should match to track 1, and detection 2 should match to track 2. Detection 3 should be unmatched.

```
[assignment,unassignedTracks,unassignedDetections] = ...
    assignDetectionsToTracks(cost,0.2);
figure;
plot(predictions(:,1),predictions(:,2),'*',detections(:,1),...
    detections(:,2),'ro');
hold on;
legend('predictions','detections');
for i = 1:size(assignment,1)
    text(predictions(assignment(i, 1),1)+0.1,...
        predictions(assignment(i,1),2)-0.1,num2str(i));
    text(detections(assignment(i, 2),1)+0.1,...
        detections(assignment(i,2),2)-0.1,num2str(i));
end
for i = 1:length(unassignedDetections)
    text(detections(unassignedDetections(i),1)+0.1,...
        detections(unassignedDetections(i),2)+0.1,'unassigned');
end
xlim([0,4]);
ylim([0,4]);
```

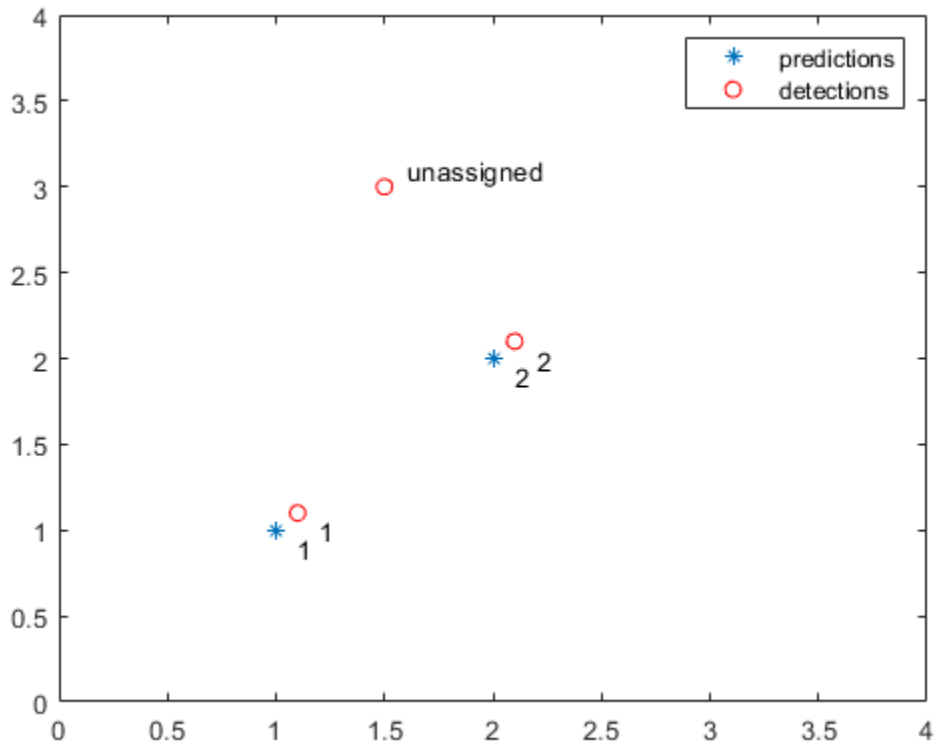

Input Arguments

costMatrix — Cost of assigning detection to track

M-by-*N* matrix

Cost of assigning a detection to a track, specified as an *M*-by-*N* matrix, where *M* represents the number of tracks, and *N* is the number of detections. The cost matrix value must be real, nonsparse, and numeric. The lower the cost, the more likely that a detection gets assigned to a track. Each value represents the cost of assigning the *N*th detection to the *M*th track. If there is no likelihood of an assignment between a detection and a track, the `costMatrix` input is set to `Inf`. Internally, this function pads the cost matrix with dummy rows and columns to account for the possibility of unassigned tracks and detections. The padded rows represent detections not assigned to any tracks. The padded columns represent tracks not associated with any detections. The function applies the Hungarian assignment algorithm to the padded matrix.

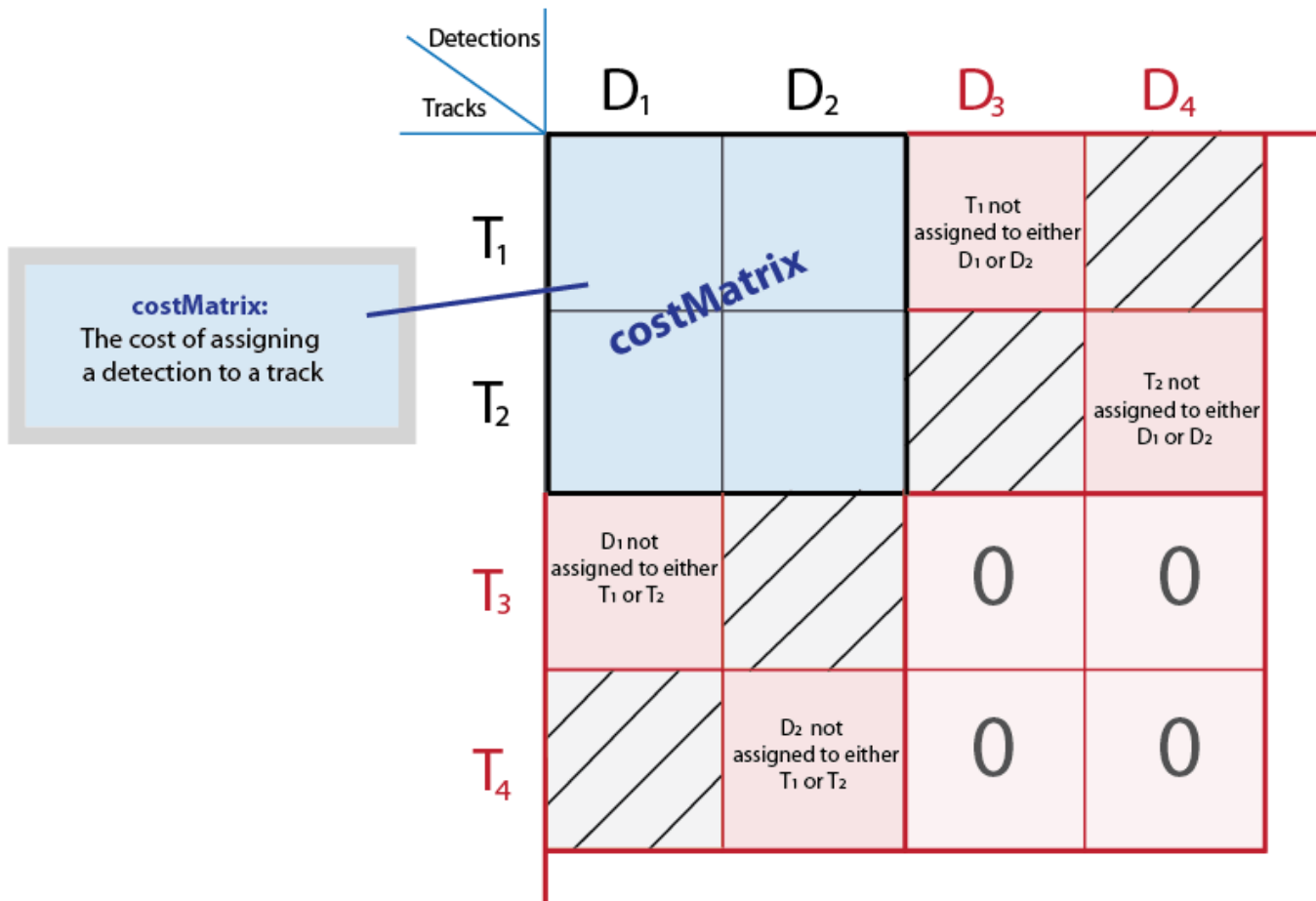

Data Types: int8 | uint8 | int16 | uint16 | int32 | uint32 | single | double

costOfNonAssignment – Cost of not assigning detection to any track or track to any detection

scalar | finite

Cost of not assigning detection to any track or track to detection. You can specify this value as a scalar value representing the cost of a track or a detection remaining unassigned. An unassigned detection may become the start of a new track. If a track is unassigned, the object does not appear. The higher the `costOfNonAssignment` value, the higher the likelihood that every track will be assigned a detection.

Internally, this function pads the cost matrix with dummy rows and columns to account for the possibility of unassigned tracks and detections. The padded rows represent detections not assigned to any tracks. The padded columns represent tracks not associated with any detections. To apply the same value to all elements in both the rows and columns, use the syntax with the `costOfNonAssignment` input. To vary the values for different detections or tracks, use the syntax with the `unassignedTrackCost` and `unassignedDetectionCost` inputs.

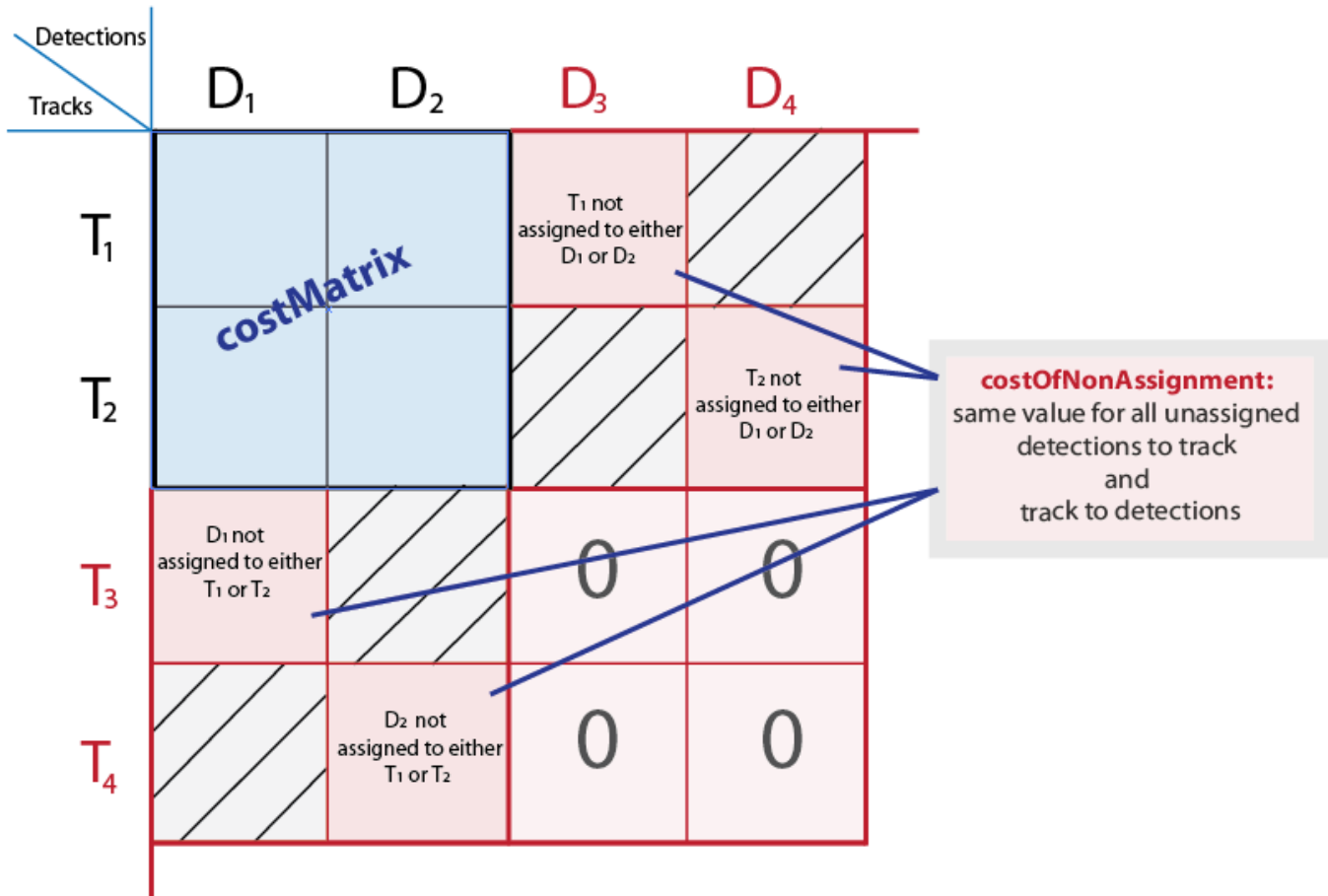

Data Types: int8 | uint8 | int16 | uint16 | int32 | uint32 | single | double

unassignedTrackCost — Cost or likelihood of an unassigned track

M-element vector | scalar | finite

Cost or likelihood of an unassigned track. You can specify this value as a scalar value, or an *M*-element vector, where *M* represents the number of tracks. For the *M*-element vector, each element represents the cost of not assigning any detection to that track. A scalar input represents the same cost of being unassigned for all tracks. The cost may vary depending on what you know about each track and the scene. For example, if an object is about to leave the field of view, the cost of the corresponding track being unassigned should be low.

Internally, this function pads the cost matrix with dummy rows and columns to account for the possibility of unassigned tracks and detections. The padded rows represent detections not assigned to any tracks. The padded columns represent tracks not associated with any detections. To vary the values for different detections or tracks, use the syntax with the `unassignedTrackCost` and `unassignedDetectionCost` inputs. To apply the same value to all elements in both the rows and columns, use the syntax with the `costOfNonAssignment` input.

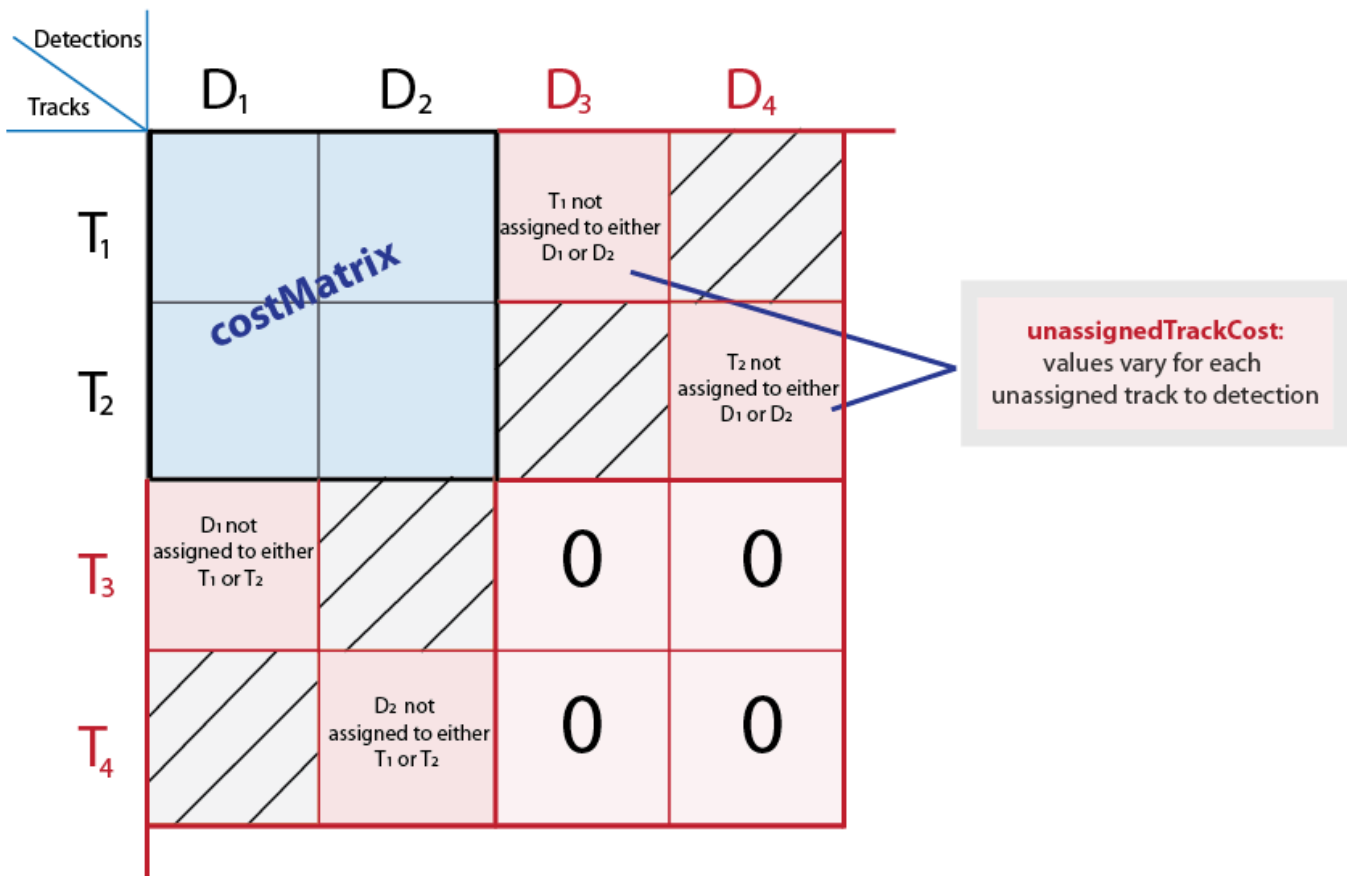

Data Types: int8 | uint8 | int16 | uint16 | int32 | uint32 | single | double

unassignedDetectionCost — Cost of unassigned detection

N-element vector | scalar | finite

Cost of unassigned detection, specified as a scalar value or an *N*-element vector, where *N* represents the number of detections. For the *N*-element vector, each element represents the cost of starting a new track for that detection. A scalar input represents the same cost of being unassigned for all tracks. The cost may vary depending on what you know about each detection and the scene. For example, if a detection appears close to the edge of the image, it is more likely to be a new object.

Internally, this function pads the cost matrix with dummy rows and columns to account for the possibility of unassigned tracks and detections. The padded rows represent detections not assigned to any tracks. The padded columns represent tracks not associated with any detections. To vary the values for different detections or tracks, use the syntax with the `unassignedTrackCost` and `unassignedDetectionCost` inputs. To apply the same value to all elements in both the rows and columns, use the syntax with the `costOfNonAssignment` input.

Detections Tracks		D ₁	D ₂	D ₃	D ₄
		T ₁	costMatrix		T ₁ not assigned to either D ₁ or D ₂
T ₂	T ₂ not assigned to either D ₁ or D ₂				
T ₃	D ₁ not assigned to either T ₁ or T ₂		0	0	
T ₄		D ₂ not assigned to either T ₁ or T ₂	0	0	

unassignedDetectionCost:
values vary for each
unassigned detection to track

Data Types: int8 | uint8 | int16 | uint16 | int32 | uint32 | single | double

Output Arguments

assignments — Index pairs of tracks and corresponding detections

L-by-2 matrix

Index pairs of tracks and corresponding detections. This value is returned as an L -by-2 matrix of index pairs, with L number of pairs. The first column represents the track index and the second column represents the detection index.

Data Types: `uint32`

unassignedTracks – Unassigned tracks

P -element vector

Unassigned tracks, returned as a P -element vector. P represents the number of unassigned tracks. Each element represents a track to which no detections are assigned.

Data Types: `uint32`

unassignedDetections – Unassigned detections

Q -element vector

Unassigned detections, returned as a Q -element vector, where Q represents the number of unassigned detections. Each element represents a detection that was not assigned to any tracks. These detections can begin new tracks.

Data Types: `uint32`

References

- [1] Miller, Matt L., Harold S. Stone, and Ingemar J. Cox, "Optimizing Murty's Ranked Assignment Method," *IEEE Transactions on Aerospace and Electronic Systems*, 33(3), 1997.
- [2] Munkres, James, "Algorithms for Assignment and Transportation Problems," *Journal of the Society for Industrial and Applied Mathematics*, Volume 5, Number 1, March, 1957.

Extended Capabilities

C/C++ Code Generation

Generate C and C++ code using MATLAB® Coder™.

See Also

`vision.KalmanFilter` | `configureKalmanFilter`

Topics

"Multiple Object Tracking"

External Websites

Munkres' Assignment Algorithm Modified for Rectangular Matrices

Introduced in R2012b

bbox2points

Convert rectangle to corner points list

Syntax

```
points = bbox2points(rectangle)
```

Description

`points = bbox2points(rectangle)` converts the input rectangle, specified as `[x y width height]` into a list of four `[x y]` corner points. The `rectangle` input must be either a single bounding box or a set of bounding boxes.

Examples

Convert Bounding Box to List of Points and Apply Rotation

Define a bounding box.

```
bbox = [10,20,50,60];
```

Convert the bounding box to a list of four points.

```
points = bbox2points(bbox);
```

Define a rotation transformation.

```
theta = 10;  
tform = affine2d([cosd(theta) -sind(theta) 0; sind(theta) cosd(theta) 0; 0 0 1]);
```

Apply the rotation.

```
points2 = transformPointsForward(tform,points);
```

Close the polygon for display.

```
points2(end+1,:) = points2(1,:);
```

Plot the rotated box.

```
plot(points2(:,1),points2(:,2), '*-');
```

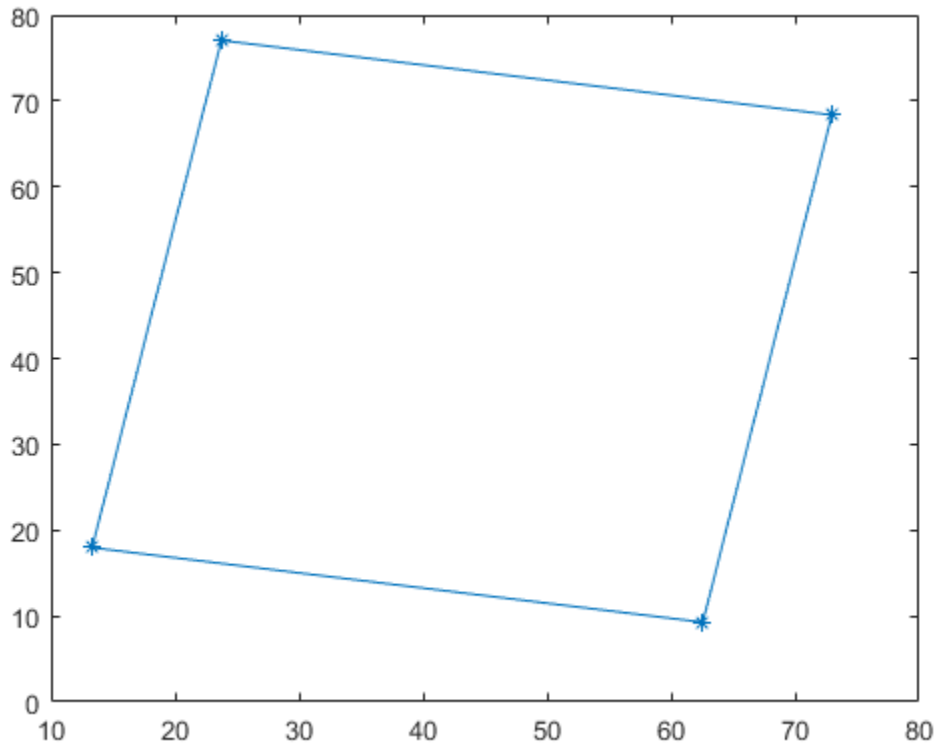

Input Arguments

rectangle — Bounding box

4-element vector | M -by-4 matrix

Bounding box, specified as a 4-element vector, $[x\ y\ width\ height]$, or a set of bounding boxes, specified as an M -by-4 matrix.

Data Types: `single` | `double` | `int16` | `int32` | `uint16` | `uint32`

Output Arguments

points — Rectangle corner coordinates

4-by-2 matrix | 4-by-2-by- M array

List of rectangle corners, returned as a 4-by-2 matrix of $[x,y]$ coordinates, or a 4-by-2-by- M array of $[x,y]$ coordinates. The output points for the rectangle are listed counterclockwise starting from the upper-left corner.

- For a single input bounding box, the function returns the 4-by-2 matrix.
- For multiple input bounding boxes, the function returns the 4-by-2- M array for M bounding boxes.

Data Types: `single` | `double` | `int16` | `int32` | `uint16` | `uint32`

Extended Capabilities

C/C++ Code Generation

Generate C and C++ code using MATLAB® Coder™.

See Also

[affine2d](#) | [projective2d](#)

Introduced in R2014b

bboxcrop

Crop bounding boxes

Syntax

```

bboxB = bboxcrop(bboxA,window)
[bboxB,indices] = bboxcrop(bboxA,window)
[ ___ ] = bboxcrop( ___, 'OverlapThreshold', threshold)

```

Description

`bboxB = bboxcrop(bboxA,window)` crops bounding boxes from a set of input bounding boxes, `bboxA`, located in the cropping area, `window`.

`[bboxB,indices] = bboxcrop(bboxA,window)` additionally returns a vector of indices that indicate which bounding boxes in `bboxA` are within the cropping window, `window`.

`[___] = bboxcrop(___, 'OverlapThreshold', threshold)` additionally sets an overlap threshold.

Examples

Center Crop Image and Corresponding Bounding Boxes

Read an image.

```
I = imread('peppers.png');
```

Define bounding boxes and labels.

```

bboxA = [
    410 230 100 90
    186 78 80 60
]

```

```

bboxA = 2×4

```

```

    410    230    100    90
    186     78     80    60

```

```

labelsA = [
    "garlic"
    "onion"
];

```

Create a center cropping window.

```

targetSize = [256 256];
win = centerCropWindow2d(size(I),targetSize);

```

Center crop the image.

```
[r,c] = deal(win.YLimits(1):win.YLimits(2),win.XLimits(1):win.XLimits(2));
J = I(r,c,:);
```

Center crop boxes and labels. Boxes outside the cropping window are removed.

```
[bboxB,indices] = bboxcrop(bboxA,win);
labelsB = labelsA(indices);
```

Display the results.

```
figure
I = insertObjectAnnotation(I, 'Rectangle', bboxA, labelsA);
J = insertObjectAnnotation(J, 'Rectangle', bboxB, labelsB);
imshowpair(I,J, 'montage')
```



Input Arguments

bboxA — Bounding boxes

M-by-4 matrix | *M*-by-5 matrix | *M*-by-9 matrix

Bounding boxes, specified as an *M*-by-4, *M*-by-5, or *M*-by-9 nonsparse numeric matrix. *M* is the number of bounding boxes. Each row of the matrix defines a bounding box as either an axis-aligned rectangle, a rotated rectangle, or a cuboid. This table describes the format for each bounding box.

Bounding Box	Description
Axis-aligned rectangle	<p data-bbox="865 300 1442 394">Defined in pixel coordinates as an M-by-4 numeric matrix with rows of the form $[x\ y\ w\ h]$, where:</p> <ul data-bbox="865 415 1455 667" style="list-style-type: none"><li data-bbox="865 415 1430 447">• M is the number of axis-aligned rectangles.<li data-bbox="865 457 1425 520">• x and y specify the upper-left corner of the rectangle.<li data-bbox="865 531 1450 594">• w specifies the width of the rectangle, which is its length along the x-axis.<li data-bbox="865 604 1455 667">• h specifies the height of the rectangle, which is its length along the y-axis.

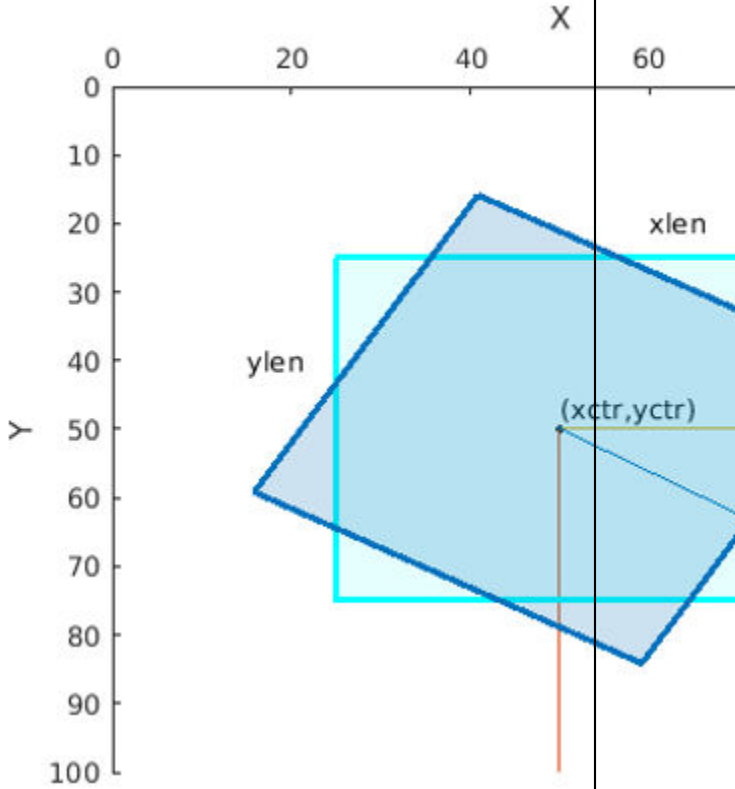
Bounding Box	Description
Rotated rectangle	<p>Defined in spatial coordinates as an M-by-5 numeric matrix with rows of the form $[xctr\ yctr\ xlen\ ylen\ yaw]$, where:</p> <ul style="list-style-type: none"> • M is the number of rotated rectangles. • $xctr$ and $yctr$ specify the center of the rectangle. • $xlen$ specifies the width of the rectangle, which is its length along the x-axis before rotation. • $ylen$ specifies the height of the rectangle, which is its length along the y-axis before rotation. • yaw specifies the rotation angle in degrees. The rotation is clockwise-positive around the center of the bounding box. 

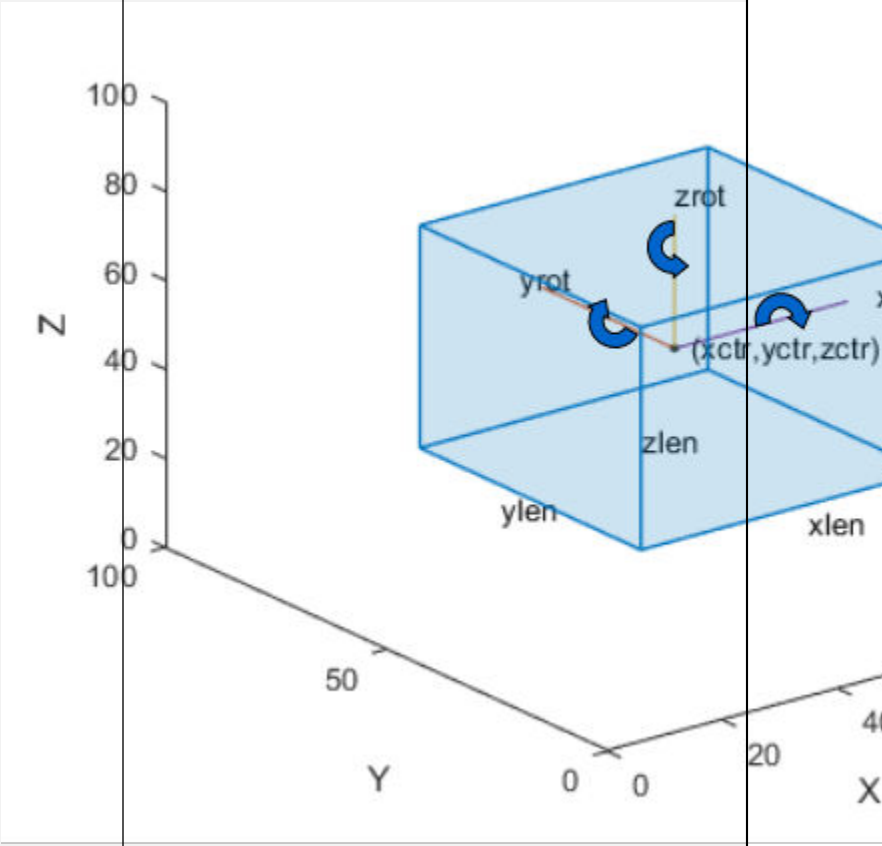
Bounding Box	Description
Cuboid	<p>Defined in spatial coordinates as an M-by-9 numeric matrix with rows of the form $[xctr\ yctr\ zctr\ xlen\ ylen\ zlen\ xrot\ yrot\ zrot]$, where:</p> <ul style="list-style-type: none"> • M is the number of cuboids. • $xctr$, $yctr$, and $zctr$ specify the center of the cuboid. • $xlen$, $ylen$, and $zlen$ specify the length of the cuboid along the x-axis, y-axis, and z-axis, respectively, before rotation. • $xrot$, $yrot$, and $zrot$ specify the rotation angles of the cuboid around the x-axis, y-axis, and z-axis, respectively. The $xrot$, $yrot$, and $zrot$ rotation angles are in degrees about the cuboid center. Each rotation is clockwise-positive with respect to the positive direction of the associated spatial axis. The function computes rotation matrices assuming ZYX order Euler angles $[xrot\ yrot\ zrot]$. <p>The figure shows how these values determine the position of a cuboid.</p> 

window — Crop window

four-element vector (default) | `images.spatialref.Cuboid` | numeric | image

Crop window, specified as a four-element vector or a `Cuboid` object.

When you specify `bboxA` as a rectangular input, the cropping window must be a four-element vector in the format `[x,y,width,height]`.

When you specify `bboxA` as a cuboid, the cropping window must be an `Cuboid` object.

threshold — Overlap threshold

1 (default) | positive scalar less than or equal to 1

Overlap threshold, specified as a positive scalar less than or equal to 1. The amount of overlap between transformed boxes and the area defined by the output view is defined as:

$(\text{bbox area intersect bounding rectangle}) / (\text{bbox area})$

- *bounding rectangle* — Defined by the input spatial reference object, `ref`.
- *bbox* — Result of transforming boxes in `bboxA`.

If the computed overlap value is greater than the value of the `threshold` property, then the transformed boxes are clipped to the bounding rectangle border. Otherwise, the boxes are discarded. Lowering the threshold can result in parts of the object getting discarded.

Output Arguments

bboxB — Cropped bounding boxes

$M2$ -by- N matrix | nonsparse numeric

Cropped bounding boxes, returned as an $M2$ -by- N matrix of $M2$ bounding boxes. The number of bounding boxes returned is less than the number of bounding boxes in the input. Each row, $M2$, of the matrix defines one bounding box of the same type as the input `bboxA`.

indices — Indices

vector of integers

Indices, returned as a vector of integers. The indices indicate which bounding boxes in the input, `bboxA`, are within the cropping window.

See Also

`imcrop` | `bboxresize` | `bboxwarp` | `bboxerase`

Introduced in R2019b

bboxresize

Resize bounding boxes

Syntax

```
bboxB = bboxresize(bboxA,scale)
```

Description

`bboxB = bboxresize(bboxA,scale)` resizes bounding boxes in `bboxA` by the amount specified by `scale`.

Examples

Resize Image and Corresponding Bounding Boxes

Read an image.

```
I = imread('peppers.png');
```

Define bounding boxes and labels.

```
bboxA = [  
    410 230 100 90  
    186 78 80 60  
    ]
```

```
bboxA = 2×4
```

```
    410    230    100    90  
    186     78     80    60
```

```
labelsA = [  
    "garlic"  
    "onion"  
    ];
```

Resize the image and the bounding boxes.

```
scale = 1.5;  
J = imresize(I,scale);  
bboxB = bboxresize(bboxA,scale);
```

Display the results.

```
figure  
I = insertObjectAnnotation(I, 'Rectangle', bboxA, labelsA);  
J = insertObjectAnnotation(J, 'Rectangle', bboxB, labelsA);  
imshowpair(I,J, 'montage')
```



Input Arguments

bboxA — Bounding boxes

M-by-4 matrix | *M*-by-5 matrix | *M*-by-9 matrix | nonsparse numeric

Bounding boxes, specified as an *M*-by-4, *M*-by-5, or *M*-by-9 nonsparse numeric matrix of *M* bounding boxes. Each row, *M*, of the matrix defines a bounding box as either an axis-aligned rectangle, a rotate rectangle, or a cuboid. The table below describes the format of the bounding boxes.

Bounding Box	Description
Axis-aligned rectangle	<p>Defined in pixel coordinates as an <i>M</i>-by-4 numeric matrix with rows of the form $[x \ y \ w \ h]$, where:</p> <ul style="list-style-type: none"> • <i>M</i> is the number of axis-aligned rectangles. • <i>x</i> and <i>y</i> specify the upper-left corner of the rectangle. • <i>w</i> specifies the width of the rectangle, which is its length along the <i>x</i>-axis. • <i>h</i> specifies the height of the rectangle, which is its length along the <i>y</i>-axis.

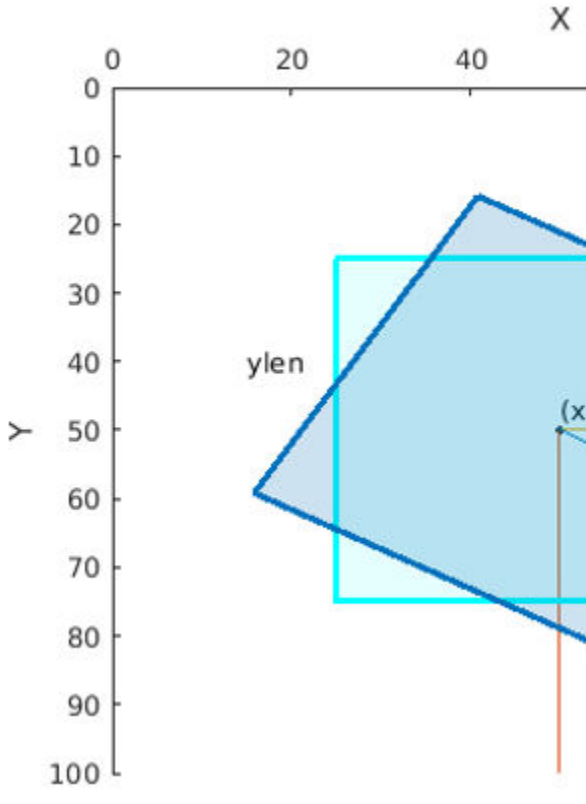
Bounding Box	Description
Rotated rectangle	<p>Defined in spatial coordinates as an M-by-5 numeric matrix with rows of the form $[xctr\ yctr\ xlen\ ylen\ yaw]$, where:</p> <ul style="list-style-type: none"> • M is the number of rotated rectangles. • $xctr$ and $yctr$ specify the center of the rectangle. • $xlen$ specifies the width of the rectangle, which is its length along the x-axis before rotation. • $ylen$ specifies the height of the rectangle, which is its length along the y-axis before rotation. • yaw specifies the rotation angle in degrees. The rotation is clockwise-positive around the center of the bounding box. 

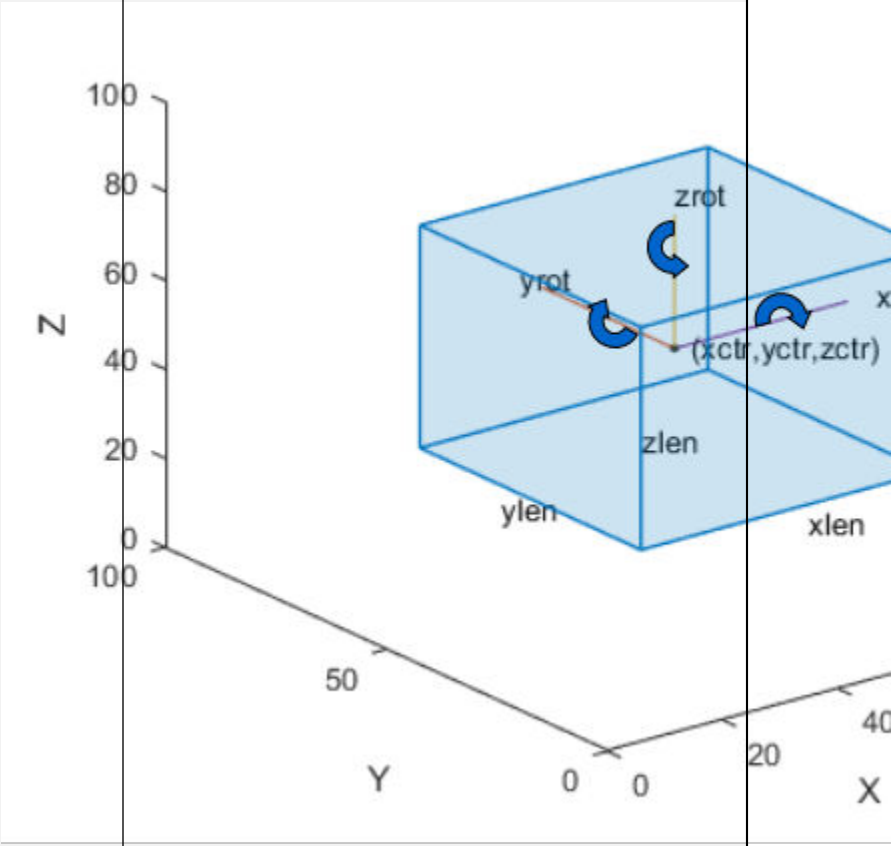
Bounding Box	Description
Cuboid	<p>Defined in spatial coordinates as an M-by-9 numeric matrix with rows of the form $[xctr\ yctr\ zctr\ xlen\ ylen\ zlen\ xrot\ yrot\ zrot]$, where:</p> <ul style="list-style-type: none"> • M is the number of cuboids. • $xctr$, $yctr$, and $zctr$ specify the center of the cuboid. • $xlen$, $ylen$, and $zlen$ specify the length of the cuboid along the x-axis, y-axis, and z-axis, respectively, before rotation. • $xrot$, $yrot$, and $zrot$ specify the rotation angles of the cuboid around the x-axis, y-axis, and z-axis, respectively. The $xrot$, $yrot$, and $zrot$ rotation angles are in degrees about the cuboid center. Each rotation is clockwise-positive with respect to the positive direction of the associated spatial axis. The function computes rotation matrices assuming ZYX order Euler angles $[xrot\ yrot\ zrot]$. <p>The figure shows how these values determine the position of a cuboid.</p> 

scale — Scale

scalar (default) | row vector

Scale, specified as a scalar or a row vector. When you specify a scalar, the function applies the same scale factor to the height and width of the bounding boxes in `bboxA`. When you specify a row vector, the function applies the factor in the first element of the vector to resize the height and the second element to resize the width of the bounding boxes.

Output Arguments**bboxB — Warped bounding boxes***M2*-by-*N* matrix | nonsparse numeric

Warped bounding boxes, returned as an *M2*-by-*N* matrix of *M2* bounding boxes. The number of bounding boxes returned is less than the number of bounding boxes in the input. Each row, *M2*, of the matrix defines one bounding box of the same type as the input `bboxA`.

See Also

bboxcrop | bboxwarp | bboxerase | imresize

Introduced in R2019b

bboxwarp

Apply geometric transformation to bounding boxes

Syntax

```
bboxB = bboxwarp(bboxA,tform,ref)
[bboxB,indices] = bboxwarp(bboxA,tform,ref)
[ ___ ] = bboxwarp( ___, 'OverlapThreshold', threshold)
```

Description

`bboxB = bboxwarp(bboxA,tform,ref)` transforms bounding boxes in `bboxA` according to the geometric transformation defined by `tform`. Bounding boxes can be axis-aligned rectangles, rotated rectangles, or cuboids. The spatial reference object, `ref`, defines the output view into which the boxes are transformed.

`[bboxB,indices] = bboxwarp(bboxA,tform,ref)` additionally returns a vector of indices that indicate which bounding boxes in `bboxA` correspond to the warped versions in the output, `bboxB`.

`[___] = bboxwarp(___, 'OverlapThreshold', threshold)` additionally sets an overlap threshold.

Examples

Transform Images and Corresponding Bounding Boxes

Read an image.

```
I = imread('peppers.png');
```

Define bounding boxes and labels.

```
bboxA = [
    410 230 100 90
    186 78 80 60
];
```

```
bboxA = 2×4
```

```
    410    230    100    90
    186     78     80    60
```

```
labelsA = [
    "garlic"
    "onion"
];
```

Define a transform to horizontally flip and translate the image.

```
tform = affine2d([-1 0 0; 0 1 0; 50 50 1]);
```

Create an output view for `imwarp`.

```
rout = affineOutputView(size(I),tform);
```

Warp the image.

```
J = imwarp(I,tform,'OutputView',rout);
```

Warp the boxes.

```
[bboxB,indices] = bboxwarp(bboxA,tform,rout);
labelsB = labelsA(indices);
```

Display the results.

```
annotatedI = insertObjectAnnotation(I,'Rectangle',bboxA,labelsA);
annotatedJ = insertObjectAnnotation(J,'Rectangle',bboxB,labelsB);
figure
montage({annotatedI, annotatedJ})
```



Input Arguments

bboxA — Bounding boxes

M-by-4 matrix | *M*-by-5 matrix | *M*-by-9 matrix | nonsparse numeric

Bounding boxes, specified as an *M*-by-4, *M*-by-5, or *M*-by-9 nonsparse numeric matrix of *M* bounding boxes. Each row, *M*, of the matrix defines a bounding box as either an axis-aligned rectangle, a rotated rectangle, or a cuboid. The table below describes the format of the bounding boxes.

Bounding Box	Description
Axis-aligned rectangle	<p>Defined in pixel coordinates as an M-by-4 numeric matrix with rows of the form $[x\ y\ w\ h]$, where:</p> <ul style="list-style-type: none">• M is the number of axis-aligned rectangles.• x and y specify the upper-left corner of the rectangle.• w specifies the width of the rectangle, which is its length along the x-axis.• h specifies the height of the rectangle, which is its length along the y-axis.

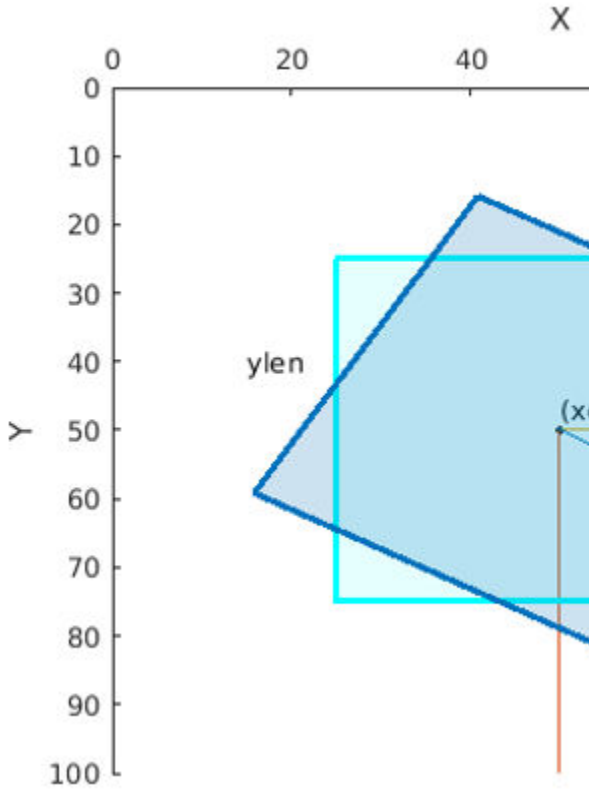
Bounding Box	Description
Rotated rectangle	<p>Defined in spatial coordinates as an M-by-5 numeric matrix with rows of the form $[xctr\ yctr\ xlen\ ylen\ yaw]$, where:</p> <ul style="list-style-type: none"> • M is the number of rotated rectangles. • $xctr$ and $yctr$ specify the center of the rectangle. • $xlen$ specifies the width of the rectangle, which is its length along the x-axis before rotation. • $ylen$ specifies the height of the rectangle, which is its length along the y-axis before rotation. • yaw specifies the rotation angle in degrees. The rotation is clockwise-positive around the center of the bounding box. 

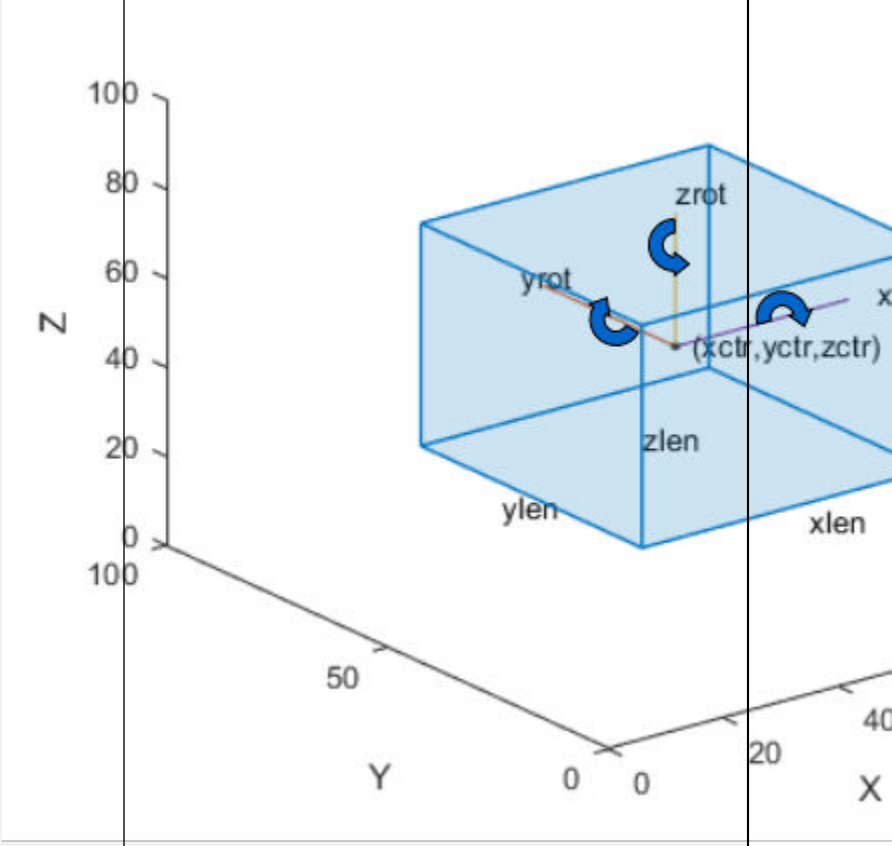
Bounding Box	Description
Cuboid	<p>Defined in spatial coordinates as an M-by-9 numeric matrix with rows of the form $[xctr\ yctr\ zctr\ xlen\ ylen\ zlen\ xrot\ yrot\ zrot]$, where:</p> <ul style="list-style-type: none"> • M is the number of cuboids. • $xctr$, $yctr$, and $zctr$ specify the center of the cuboid. • $xlen$, $ylen$, and $zlen$ specify the length of the cuboid along the x-axis, y-axis, and z-axis, respectively, before rotation. • $xrot$, $yrot$, and $zrot$ specify the rotation angles of the cuboid around the x-axis, y-axis, and z-axis, respectively. The $xrot$, $yrot$, and $zrot$ rotation angles are in degrees about the cuboid center. Each rotation is clockwise-positive with respect to the positive direction of the associated spatial axis. The function computes rotation matrices assuming ZYX order Euler angles $[xrot\ yrot\ zrot]$. <p>The figure shows how these values determine the position of a cuboid.</p> 

tform — Geometric transformation

affine2d object (default)

Geometric transformation, specified in an `affine2d` object. `bboxwarp` function supports only scale, rotation, and translation affine transformations.

ref — Spatial reference

imref2d object

Spatial reference, specified as an `imref2d` object returned by the `imwarp` or `affineOutputView` function. The object defines the output view to transform boxes. Boxes that are transformed completely outside of the output view defined by `ref` are discarded.

```
[J, rout] = imwarp(I, tform);
[bboxB, indices] = bboxwarp(bboxA, tform, rout);
```

```
rout = affineOutputView(size(I), tform)
J = imwarp(I, tform, 'OutputView', rout);
[bboxB, indices] = bboxwarp(bboxA, tform, rout);
```

threshold — Overlap threshold

1 (default) | positive scalar less than or equal to 1

Overlap threshold, specified as a positive scalar less than or equal to 1. The amount of overlap between transformed boxes and the area defined by the output view is defined as:

$$\text{area}(\text{bbox intersect bounding rectangle}) / \text{area}(\text{bbox})$$

- *bounding rectangle* — Defined by the input spatial reference object, `ref`.
- *bbox* — Result of transforming boxes in `bboxA`.

If the computed overlap value is greater than the value of the `threshold` property, then the transformed boxes are clipped to the bounding rectangle border. Otherwise, the boxes are discarded. Lowering the threshold can result in parts of the object getting discarded.

Output Arguments**bboxB — Warped bounding boxes** $M2$ -by- N matrix | nonsparse numeric

Warped bounding boxes, returned as an $M2$ -by- N matrix of $M2$ bounding boxes. The number of bounding boxes returned is less than the number of bounding boxes in the input. Each row, $M2$, of the matrix defines one bounding box of the same type as the input `bboxA`.

indices — Indices

vector of integers

Indices, returned as a vector of integers. The indices indicate which bounding boxes in the input, `bboxA`, that correspond to the warped versions in the output, `bboxB`.

See Also

`imcrop` | `bboxcrop` | `bboxresize` | `imwarp` | `bboxerase`

Introduced in R2019b

bboxOverlapRatio

Compute bounding box overlap ratio

Syntax

```
overlapRatio = bboxOverlapRatio(bboxA,bboxB)
overlapRatio = bboxOverlapRatio(bboxA,bboxB,ratioType)
```

Description

`overlapRatio = bboxOverlapRatio(bboxA,bboxB)` returns the overlap ratio between each pair of bounding boxes `bboxA` and `bboxB`. The function returns the `overlapRatio` value between 0 and 1, where 1 implies a perfect overlap.

`overlapRatio = bboxOverlapRatio(bboxA,bboxB,ratioType)` additionally lets you specify the method to use for computing the ratio. You must set the `ratioType` to either 'Union' or 'Min'.

Examples

Compute the Overlap Ratio Between Two Bounding Boxes

Define two bounding boxes in the format [x y width height].

```
bboxA = [150,80,100,100];
bboxB = bboxA + 50;
```

Display the bounding boxes on an image.

```
I = imread('peppers.png');
RGB = insertShape(I,'FilledRectangle',bboxA,'Color','green');
RGB = insertShape(RGB,'FilledRectangle',bboxB,'Color','yellow');
imshow(RGB)
```



Compute the overlap ratio between the two bounding boxes.

```
overlapRatio = bboxOverlapRatio(bboxA,bboxB)  
overlapRatio = 0.0833
```

Compute Overlap Ratio Between Each Pair of Bounding Boxes

Randomly generate two sets of bounding boxes.

```
bboxA = 10*rand(5,4);  
bboxB = 10*rand(10,4);
```

Ensure that the width and height of the boxes are positive.

```
bboxA(:,3:4) = bboxA(:,3:4) + 10;  
bboxB(:,3:4) = bboxB(:,3:4) + 10;
```

Compute the overlap ratio between each pair.

```
overlapRatio = bboxOverlapRatio(bboxA,bboxB)
```

```
overlapRatio = 5×10
```

```

0.2431  0.2329  0.3418  0.5117  0.7972  0.1567  0.1789  0.4339  0.0906  0.5
0.3420  0.1655  0.7375  0.5188  0.2786  0.3050  0.2969  0.4350  0.2477  0.
0.4844  0.3290  0.3448  0.1500  0.1854  0.4976  0.5629  0.4430  0.5027  0.
0.3681  0.0825  0.3499  0.0840  0.0658  0.5921  0.6498  0.1930  0.7433  0.
0.3752  0.1114  0.3114  0.0696  0.0654  0.5408  0.6234  0.2046  0.7557  0.

```

Input Arguments

bboxA — Bounding box

M-by-4 matrix | *M*-by-5 matrix

Bounding boxes, specified as an *M*-by-4 or *M*-by-5 nonsparse numeric matrix. *M* is the number of bounding boxes. Each row of the matrix defines a bounding box as either an axis-aligned rectangle or a rotated rectangle. This table describes the format for each bounding box.

Bounding Box	Row	Description
Axis-aligned rectangle	$[x_{\min}, y_{\min}, width, height]$	This type of bounding box is defined in pixel coordinates as an <i>M</i> -by-4 matrix representing <i>M</i> bounding boxes
Rotated rectangle	$[x_{\text{center}}, y_{\text{center}}, width, height, yaw]$	This type of bounding box is defined in spatial coordinates as an <i>M</i> -by-5 matrix representing <i>M</i> bounding boxes. The x_{center} and y_{center} coordinates represent the center of the bounding box. The <i>width</i> and <i>height</i> elements represent the length of the box along the <i>x</i> and <i>y</i> axes, respectively. The <i>yaw</i> represents the rotation angle in degrees. The amount of rotation about the center of the bounding box is measured in the clockwise direction.

Data Types: single | double | int8 | int16 | int32 | uint8 | uint16 | uint32

bboxB — Bounding box

M-by-4 matrix | *M*-by-5 matrix

Bounding boxes, specified as an *M*-by-4 or *M*-by-5 nonsparse numeric matrix. *M* is the number of bounding boxes. Each row, *M*, of the matrix defines a bounding box as either an axis-aligned rectangle or a rotated rectangle. This table describes the format for each bounding box.

Bounding Box	Row	Description
Axis-aligned rectangle	$[x_{\min}, y_{\min}, \text{width}, \text{height}]$	This type of bounding box is defined in pixel coordinates as an M -by-4 matrix representing M bounding boxes
Rotated rectangle	$[x_{\text{center}}, y_{\text{center}}, \text{width}, \text{height}, \text{yaw}]$	This type of bounding box is defined in spatial coordinates as an M -by-5 matrix representing M bounding boxes. The x_{center} and y_{center} coordinates represent the center of the bounding box. The width and height elements represent the length of the box along the x and y axes, respectively. The yaw represents the rotation angle in degrees. The amount of rotation about the center of the bounding box is measured in the clockwise direction.

Data Types: `single` | `double` | `int8` | `int16` | `int32` | `uint8` | `uint16` | `uint32`

ratioType – Ratio type

'Union' (default) | 'Min'

Ratio type, specified as the character vector 'Union' or 'Min'.

- Set the ratio type to 'Union' to compute the ratio as the area of intersection between `bboxA` and `bboxB`, divided by the area of the union of the two.
- Set the ratio type to 'Min' to compute the ratio as the area of intersection between `bboxA` and `bboxB`, divided by the minimum area of the two bounding boxes.

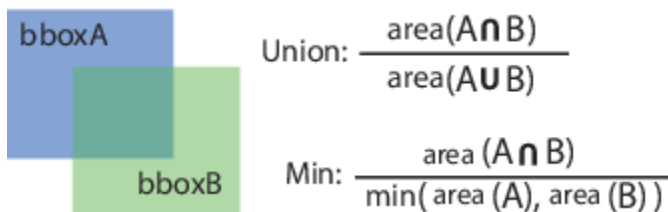

Data Types: `char`

Output Arguments

overlapRatio – Overlap ratio between two bounding boxes

M -by- N matrix

Overlap ratio between two bounding boxes, returned as an M -by- N matrix. Each (I, J) element in the output matrix corresponds to the overlap ratio between row I in `bboxA` and row J in `bboxB`. The function returns `overlapRatio` in the between 0 and 1, where 1 implies a perfect overlap. If either

`bboxA` or `bboxB` is double, then the function returns `overlapRatio` as double. Otherwise, the function returns it as `single`.

The function computes the overlap ratio based on the ratio type. You can set `ratioType` to 'Union' or 'Min':

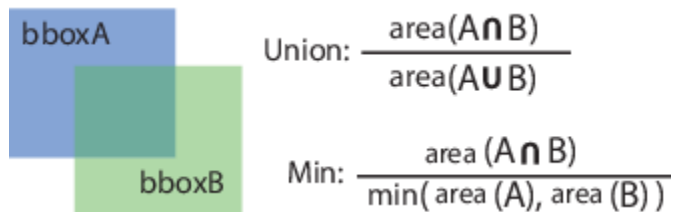

Data Types: `single` | `double`

Extended Capabilities

C/C++ Code Generation

Generate C and C++ code using MATLAB® Coder™.

Usage notes and limitations:

Code generation is not supported for rotated rectangle inputs.

See Also

`selectStrongestBbox` | `selectStrongestBboxMulticlass` | `bboxPrecisionRecall`

Topics

"Multiple Object Tracking"

Introduced in R2014b

bboxPrecisionRecall

Compute bounding box precision and recall against ground truth

Syntax

```
[precision,recall] = bboxPrecisionRecall(bboxes,groundTruthBboxes)
[precision,recall] = bboxPrecisionRecall(bboxes,groundTruthBboxes,threshold)
```

Description

`[precision,recall] = bboxPrecisionRecall(bboxes,groundTruthBboxes)` measures the accuracy of bounding box overlap between `bboxes` and `groundTruthBboxes`. Precision is a ratio of true positive instances to all positive instances of objects in the detector, based on the ground truth. Recall is a ratio of true positive instances to the sum of true positives and false negatives in the detector, based on the ground truth.

If the bounding box is associated with a class label, `precision` and `recall` contain metrics for each class. If the bounding box is also associated with a confidence score for ranking, use the `evaluateDetectionPrecision` function.

`[precision,recall] = bboxPrecisionRecall(bboxes,groundTruthBboxes,threshold)` specifies the overlap threshold for assigning a given box to a ground truth box.

Examples

Evaluate Bounding Box Overlap Accuracy

Create two ground truth boxes.

```
groundTruthBoxes = [2 2 10 20; 80 80 30 40];
```

Create three boxes for evaluation.

```
boundingBoxes = [4 4 10 20; 50 50 30 10; 90 90 40 50];
```

Plot the boxes.

```
figure
hold on
for i=1:2
    rectangle('Position',groundTruthBoxes(i,:), 'EdgeColor','r');
end
for i=1:3
    rectangle('Position',boundingBoxes(i,:), 'EdgeColor','b');
end
```

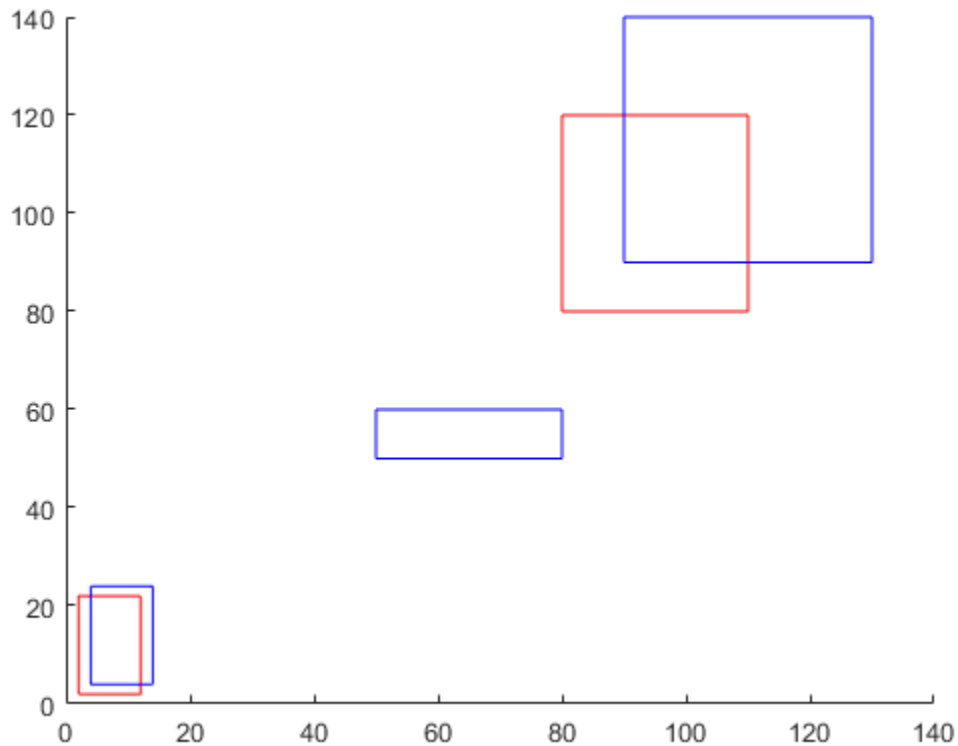

Evaluate the overlap accuracy against the ground truth data.

```
[precision,recall] = bboxPrecisionRecall(boundingBoxes,groundTruthBoxes)
precision = 0.3333
recall = 0.5000
```

Evaluate Bounding Box Overlap For Three Classes

Define class names.

```
classNames = ["A", "B", "C"];
```

Create bounding boxes for evaluation.

```
predictedLabels = {...
    categorical("A",classNames); ...
    categorical(["C";"B"],classNames)};
bboxes = {...
    [10 10 20 30]; ...
    [60 18 20 10; 120 120 5 10]};
boundingBoxes = table(bboxes,predictedLabels,'VariableNames',...
    {'PredictedBoxes','PredictedLabels'});
```

Create ground truth boxes.

```
A = {[10 10 20 28]; []};
B = {[]; [118 120 5 10]};
C = {[]; [59 19 20 10]};
groundTruthData = table(A,B,C);
```

Evaluate overlap accuracy against ground truth data.

```
[precision,recall] = bboxPrecisionRecall(boundingBoxes,groundTruthData)
```

```
precision = 3×1
```

```
1
0
1
```

```
recall = 3×1
```

```
1
0
1
```

Input Arguments

bboxes — Bounding boxes

M-by-4 matrix | table with *M* rows

Bounding boxes, specified as one of the following. *M* is the number of bounding boxes.

- For single-class bounding boxes, **bboxes** can be an *M*-by-4 matrix, or a table with *M* rows and one column. Each row of the matrix or element in the table represents a bounding box, specified in the format [*x y width height*], where *x* and *y* correspond to the upper left corner of the bounding box.
- For multi-class bounding boxes, **bboxes** is a table with *M* rows and two columns. Each element in the first column represents a bounding box, specified in the format [*x y width height*]. The second column contains the predicted label for each box. The label must be a categorical type defined by the variable (column) names of the **groundTruthBboxes** table.

Data Types: `single` | `double` | `int8` | `int16` | `int32` | `uint8` | `uint16` | `uint32`

groundTruthBboxes — Ground truth bounding boxes

M-by-4 matrix | table with *M* rows

Ground truth bounding boxes, specified as one of the following. *M* is the number of ground truth bounding boxes.

- For single-class bounding boxes, **groundTruthBboxes** can be an *M*-by-4 matrix, or a table with *M* rows and one column. Each row of the matrix or element in the table represents a bounding box, specified in the format [*x y width height*], where *x* and *y* correspond to the upper left corner of the bounding box.
- For multi-class bounding boxes, **groundTruthBboxes** is a table with *M* rows and multiple columns. Each column represents a different class, and the column name specifies the class label. Each element in the table has the format [*x y width height*].

Data Types: `single` | `double` | `int8` | `int16` | `int32` | `uint8` | `uint16` | `uint32`

threshold — Overlap threshold

0.5 | numeric scalar

Overlap threshold for assigned a detection to a ground truth box, specified as a numeric scalar. The overlap ratio is computed as the intersection over union.

Output Arguments**precision — Precision values from each detection**

numeric scalar | numeric vector

Precision values from each detection, returned as a numeric scalar for single-class bounding boxes. For multi-class bounding boxes, `precision` is returned as a numeric vector consisting of metrics for each class. The class order follows the same column order as the `groundTruthBboxes` table.

recall — Recall values from each detection

numeric scalar | numeric vector

Recall values from each detection, returned as a numeric scalar for single-class bounding boxes. For multi-class bounding boxes, `recall` is returned as a numeric vector consisting of metrics for each class. The class order follows the same column order as the `groundTruthBboxes` table.

See Also`bboxOverlapRatio` | `evaluateDetectionPrecision`**Introduced in R2018a**

bundleAdjustment

Refine 3-D points and camera poses

Syntax

```
[xyzRefinedPoints,refinedPoses] = bundleAdjustment(xyzPoints,pointTracks,
cameraPoses,intrinsics)
[ ___,reprojectionErrors] = bundleAdjustment( ___ )
[ ___ ] = bundleAdjustment( ___,Name,Value)
```

Description

`[xyzRefinedPoints,refinedPoses] = bundleAdjustment(xyzPoints,pointTracks, cameraPoses,intrinsics)` refines 3-D points and camera poses to minimize reprojection errors. The refinement procedure is a variant of the Levenberg-Marquardt algorithm. The function uses the same global reference coordinate system to return both the 3-D points and camera poses.

`[___,reprojectionErrors] = bundleAdjustment(___)` returns the mean reprojection error for each 3-D world point, in addition to the arguments from the previous syntax.

`[___] = bundleAdjustment(___,Name,Value)` specifies options using one or more name-value arguments. Unspecified arguments have default values.

Examples

Refine 3-D points and camera poses From Single Camera

Load data for initialization.

```
data = load('sfmGlobe');
```

Refine the camera poses and points.

```
[xyzRefinedPoints,refinedPoses] = ...
    bundleAdjustment(data.xyzPoints,data.pointTracks,data.cameraPoses,data.intrinsics);
```

Display the refined 3-D points and camera poses.

```
pcshow(xyzRefinedPoints,'VerticalAxis','y','VerticalAxisDir', ...
    'down','MarkerSize',45)
hold on
plotCamera(refinedPoses,'Size',0.1)
hold off
grid on
```

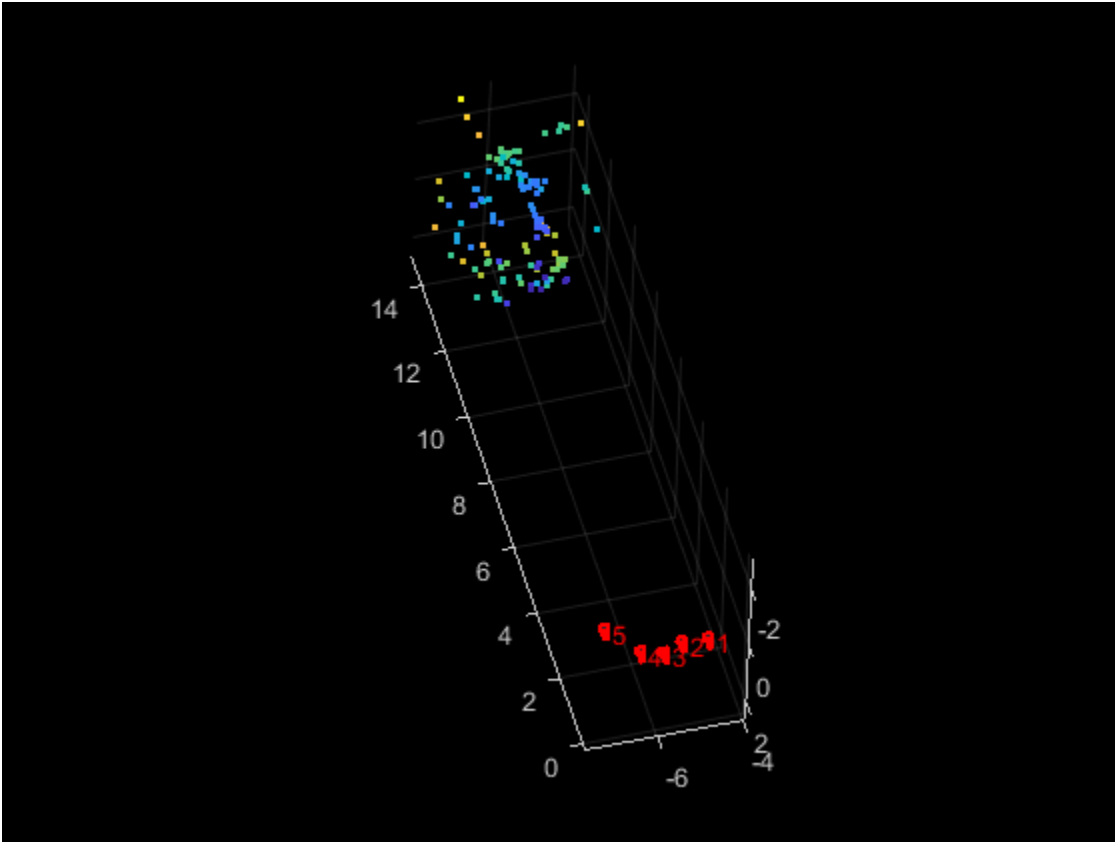

Input Arguments

xyzPoints — Unrefined 3-D points

M-by-3 matrix

Unrefined 3-D points, specified as an *M*-by-3 matrix of [x y z] locations.

pointTracks — Matching points across multiple images

N-element array of `pointTrack` objects

Matching points across multiple images, specified as an *N*-element array of `pointTrack` objects. Each element contains two or more matching points across multiple images.

cameraPoses — Camera pose information

three-column table

Camera pose `ViewId`, `Orientation`, and `Location` information, specified as a three-column table. The view IDs relate to the IDs of the objects in the `pointTracks` argument. Specify orientations as 3-by-3 rotation matrices. Specify locations as three-element vectors

intrinsics — Camera intrinsics

`cameraIntrinsics` object | *N*-element array of `cameraIntrinsics` objects

Camera intrinsics, specified as a `cameraIntrinsics` object or an *N*-element array of `cameraIntrinsics` objects. *N* is the number of camera poses. Use a single `cameraIntrinsics`

object when images are captured using the same camera. Use a vector `cameraIntrinsics` objects when images are captured by different cameras.

Name-Value Pair Arguments

Specify optional comma-separated pairs of `Name`, `Value` arguments. `Name` is the argument name and `Value` is the corresponding value. `Name` must appear inside quotes. You can specify several name and value pair arguments in any order as `Name1, Value1, ..., NameN, ValueN`.

Example: `'MaxIterations', 50`

MaxIterations — Maximum number of iterations

50 (default) | positive integer

Maximum number of iterations before the Levenberg-Marquardt algorithm stops, specified as a positive integer.

AbsoluteTolerance — Absolute termination tolerance

1.0 (default) | positive scalar

Absolute termination tolerance of the mean squared reprojection error in pixels, specified as positive scalar.

RelativeTolerance — Relative termination tolerance

1e-5 (default) | positive scalar

Relative termination tolerance of the reduction in reprojection error between iterations, specified as positive scalar.

PointsUndistorted — Flag to indicate lens distortion

false (default) | true

Flag to indicate lens distortion, specified as `false` or `true`. When you set `PointsUndistorted` to `false`, the 2-D points in `pointTracks` must be from images with lens distortion. To use undistorted points, first use the `undistortImage` function to remove distortions from the images, then set `PointsUndistorted`.

FixedViewIDs — View IDs for fixed camera pose

[] (default) | vector of nonnegative integers

View IDs for fixed camera pose, specified as a vector of nonnegative integers. Each ID corresponds to the `ViewId` of a fixed camera pose in `cameraPoses`. An empty value for `FixedViewIDs` means that all camera poses are optimized.

Solver — Solver

'sparse-linear-algebra' (default) | 'preconditioned-conjugate-gradient'

Solver, specified as `'sparse-linear-algebra'` or `'preconditioned-conjugate-gradient'`. Use the `'sparse-linear-algebra'` solver for low sparsity images. Low sparsity indicates that many camera views observe some of the same world points. Use the `'preconditioned-conjugate-gradient'` (PCG) solver, from the general graphic optimization (g2o) library, for high sparsity images. High sparsity indicates that each camera view observes, only a small portion of the world points, specified by `xyzPoints`.

Verbose — Display progress information

false (default) | true

Display progress information, specified as `false` or `true`.

Output Arguments

xyzRefinedPoints — 3-D locations of refined world points

M-by-3 matrix

3-D locations of refined world points, returned as an *M*-by-3 matrix of $[x\ y\ z]$ locations.

Data Types: `single` | `double`

refinedPoses — Refined camera poses

three-column table

Refined camera poses, returned as a three-column table. The table contains columns for `ViewId`, `Orientation`, and `Location`.

reprojectionErrors — Reprojection errors

M-element vector

Reprojection errors, returned as an *M*-element vector. The function projects each world point back into each camera. Then, in each image, the function calculates the reprojection error as the distance between the detected and the reprojected point. The `reprojectionErrors` vector contains the average reprojection error for each world point.



References

- [1] Lourakis, Manolis I. A., and Antonis A. Argyros. "SBA: A Software Package for Generic Sparse Bundle Adjustment." *ACM Transactions on Mathematical Software* 36, no. 1 (March 2009): 2:1-2:30.
- [2] Hartley, Richard, and Andrew Zisserman. *Multiple View Geometry in Computer Vision*. 2nd ed. Cambridge, UK; New York: Cambridge University Press, 2003.
- [3] Triggs, Bill, Philip F. McLauchlan, Richard I. Hartley, and Andrew W. Fitzgibbon. "Bundle Adjustment — A Modern Synthesis." In *Proceedings of the International Workshop on Vision Algorithms*, 298-372. Springer-Verlag, 1999.

See Also

Functions

`bundleAdjustmentMotion` | `bundleAdjustmentStructure` | `relativeCameraPose` | `undistortImage` | `undistortPoints` | `cameraMatrix` | `triangulateMultiview`

Objects

cameraIntrinsics | pointTrack | viewSet | cameraParameters

Topics

“Structure From Motion From Two Views”

“Structure From Motion From Multiple Views”

“Code Generation for Depth Estimation From Stereo Video”

“Structure from Motion Overview”

Introduced in R2016a

bundleAdjustmentMotion

Refine camera pose using motion-only bundle adjustment

Syntax

```
refinedPose = bundleAdjustmentMotion(xyzPoints,imagePoints,absolutePose,
intrinsic)
[refinedPose,reprojectionErrors] = bundleAdjustmentMotion( ___ )
[ ___ ] = bundleAdjustmentMotion( ___ ,Name,Value)
```

Description

`refinedPose = bundleAdjustmentMotion(xyzPoints,imagePoints,absolutePose,intrinsic)` returns the refined absolute camera pose that minimizes reprojection errors.

The motion-only refinement procedure is a special case of the Levenberg-Marquardt algorithm for bundle adjustment with 3-D points fixed during optimization. The 3-D points and the camera pose are placed in the same world coordinate system.

`[refinedPose,reprojectionErrors] = bundleAdjustmentMotion(___)` additionally returns an N -element vector containing the mean reprojection error for each 3-D world point using the arguments from the previous syntax.

`[___] = bundleAdjustmentMotion(___ ,Name,Value)` uses additional options specified by one or more `Name, Value` pair arguments. Unspecified properties have default values.

Examples

Refine Absolute Camera Pose

Load data for initialization into the workspace.

```
data = load('motionOnlyBA.mat');
```

Refine the absolute camera poses.

```
refinedPose = bundleAdjustmentMotion(data.xyzPoints,data.imagePoints,data.absPose,data.intrinsic);
```

Display the 3-D world points.

```
pcshow(data.xyzPoints,'VerticalAxis','y','VerticalAxisDir','down','MarkerSize',45);
hold on
```

Plot the absolute camera poses before and after refinement.

```
plotCamera('AbsolutePose',data.absPose,'Color','r','Size',2);
plotCamera('AbsolutePose',refinedPose,'Color','m','Size',2);
```

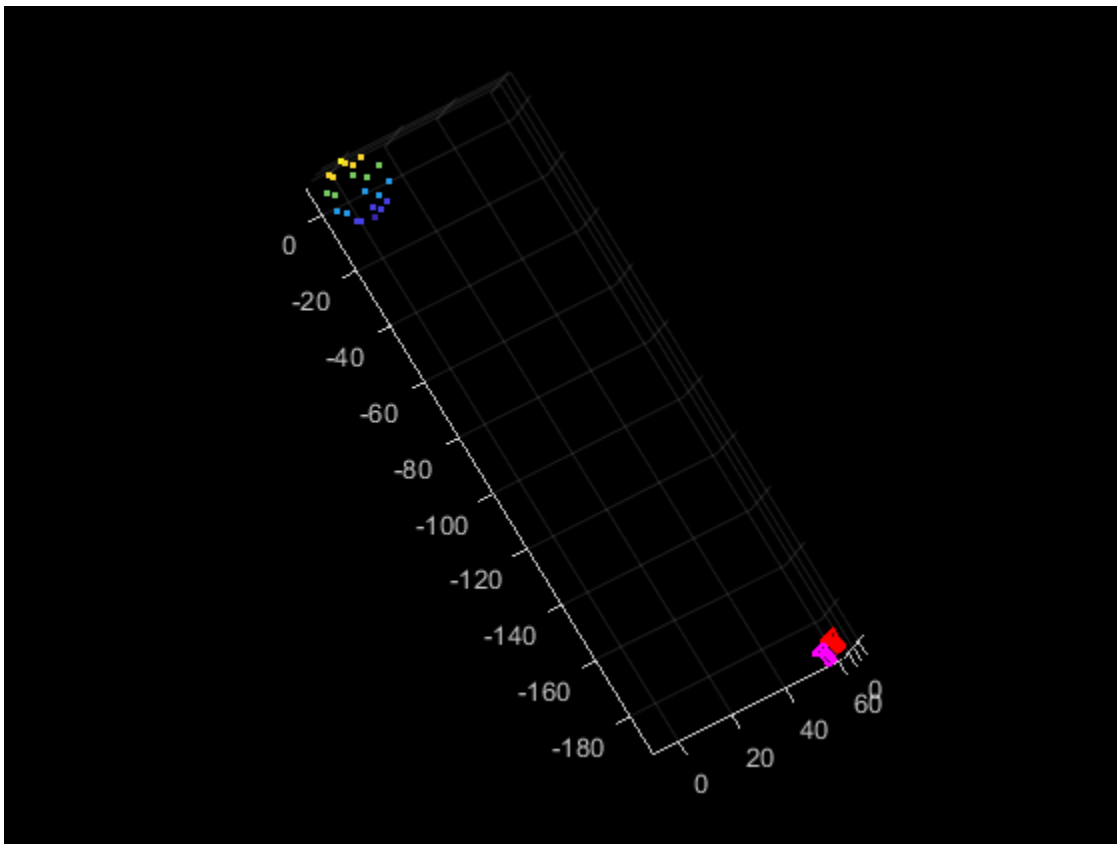

Input Arguments

xyzPoints — Unrefined 3-D points

M-by-3 matrix

Unrefined 3-D points, specified as an *M*-by-3 matrix of $[x,y,z]$ locations.

Data Types: `single` | `double`

imagePoints — Image points

M-by-2 matrix | *M*-element feature point array

Image points, specified as an *M*-by-2 matrix or an *M*-element “Point Feature Types” array.

absolutePose — Absolute camera pose

scalar `rigid3d` object

Absolute camera pose, specified as a scalar `rigid3d` object.

intrinsics — Camera intrinsics

`cameraIntrinsics` object

Camera intrinsics, specified as a `cameraIntrinsics` object.

Name-Value Pair Arguments

Specify optional comma-separated pairs of `Name`, `Value` arguments. `Name` is the argument name and `Value` is the corresponding value. `Name` must appear inside quotes. You can specify several name and value pair arguments in any order as `Name1, Value1, . . . , NameN, ValueN`.

Example: `'MaxIterations', '50'`

MaxIterations — Maximum number of iterations

50 (default) | positive integer

Maximum number of iterations before the Levenberg-Marquardt algorithm stops, specified as the comma-separated pair consisting of `'MaxIterations'` and a positive integer.

AbsoluteTolerance — Absolute termination tolerance

1.0 (default) | positive scalar

Absolute termination tolerance of the mean squared reprojection error in pixels, specified as the comma-separated pair consisting of `'AbsoluteTolerance'` and a positive scalar.

RelativeTolerance — Relative termination tolerance

1e-5 (default) | positive scalar

Relative termination tolerance of the reduction in reprojection error between iterations, specified as the comma-separated pair consisting of `'RelativeTolerance'` and a positive scalar.

PointsUndistorted — Flag to indicate lens distortion

false (default) | true

Flag to indicate lens distortion, specified as the comma-separated pair consisting of `'PointsUndistorted'` and either `false` or `true`. When you set `PointsUndistorted` to `false`, the 2-D points in `pointTracks` must be from images with lens distortion. To use undistorted points, use the `undistortImage` function first, then set `PointsUndistorted` to `true`.

Verbose — Display progress information

false (default) | true

Display progress information, specified as the comma-separated pair consisting of `'Verbose'` and either `false` or `true`.

Output Arguments

refinedPose — Refined absolute pose

scalar rigid3d object

Refined absolute pose of the camera, returned as a `rigid3d` object.

reprojectionErrors — Reprojection errors

M -element vector

Reprojection errors, returned as an M -element vector. The function projects each world point back into each camera. Then in each image, the function calculates the reprojection error as the distance between the detected and the reprojected point. The `reprojectionErrors` vector contains the average reprojection error for each world point.

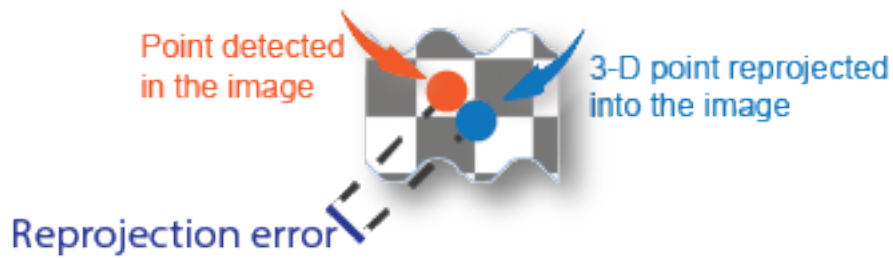

References

- [1] Lourakis, M.I.A. and A.A. Argyros. "SBA: A Software Package for Generic Sparse Bundle Adjustment". *ACM Transactions on Mathematical Software*. Volume 36, Issue 1. March 2009.
- [2] Hartley, R. and A. Zisserman. "Multiple View Geometry in Computer Vision". *Cambridge University Press*. 2003
- [3] Triggs, B., P. McLauchlan, R. Hartley, and A. Fitzgibbon. "Bundle Adjustment: A Modern Synthesis". *Proceedings of the International Workshop on Vision Algorithms: Theory and Practice*. Pages 298 — 372. Springer-Verlag. 1999.

See Also

Objects

`rigid3d` | `imageviewset` | `cameraParameters` | `cameraIntrinsics`

Functions

`bundleAdjustment` | `bundleAdjustmentStructure`

Topics

"Point Feature Types"

Introduced in R2020a

bundleAdjustmentStructure

Refine 3-D points using structure-only bundle adjustment

Syntax

```
xyzRefinedPoints = bundleAdjustmentStructure(xyzPoints,pointTracks,
cameraPoses,intrinsics)
[xyzRefinedPoints,reprojectionErrors] = bundleAdjustmentStructure( ___ )
[ ___ ] = bundleAdjustmentStructure( ___ ,Name,Value)
```

Description

`xyzRefinedPoints = bundleAdjustmentStructure(xyzPoints,pointTracks, cameraPoses,intrinsics)` returns the refined 3-D points that minimize reprojection errors.

The structure-only refinement procedure is a special case of bundle adjustment with camera poses fixed during optimization. The 3-D points and the camera poses are placed in the same world coordinate system.

`[xyzRefinedPoints,reprojectionErrors] = bundleAdjustmentStructure(___)` additionally returns an N -element vector containing the mean reprojection error for each 3-D world point using the arguments from the previous syntax.

`[___] = bundleAdjustmentStructure(___ ,Name,Value)` uses additional options specified by one or more `Name,Value` pair arguments. Unspecified properties have default values.

Examples

Refine 3-D Points From Single Camera

Load data for initialization.

```
data = load('sfmGlobe');
```

Refine the 3-D world points.

```
xyzRefinedPoints = bundleAdjustmentStructure(data.xyzPoints,data.pointTracks,data.cameraPoses,da
```

Display the refined 3-D world points.

```
pcshow(xyzRefinedPoints,'VerticalAxis','y','VerticalAxisDir','down','MarkerSize',45);
```

Display the cameras.

```
hold on
plotCamera(data.cameraPoses,'Size',0.2);
hold off
grid on
```

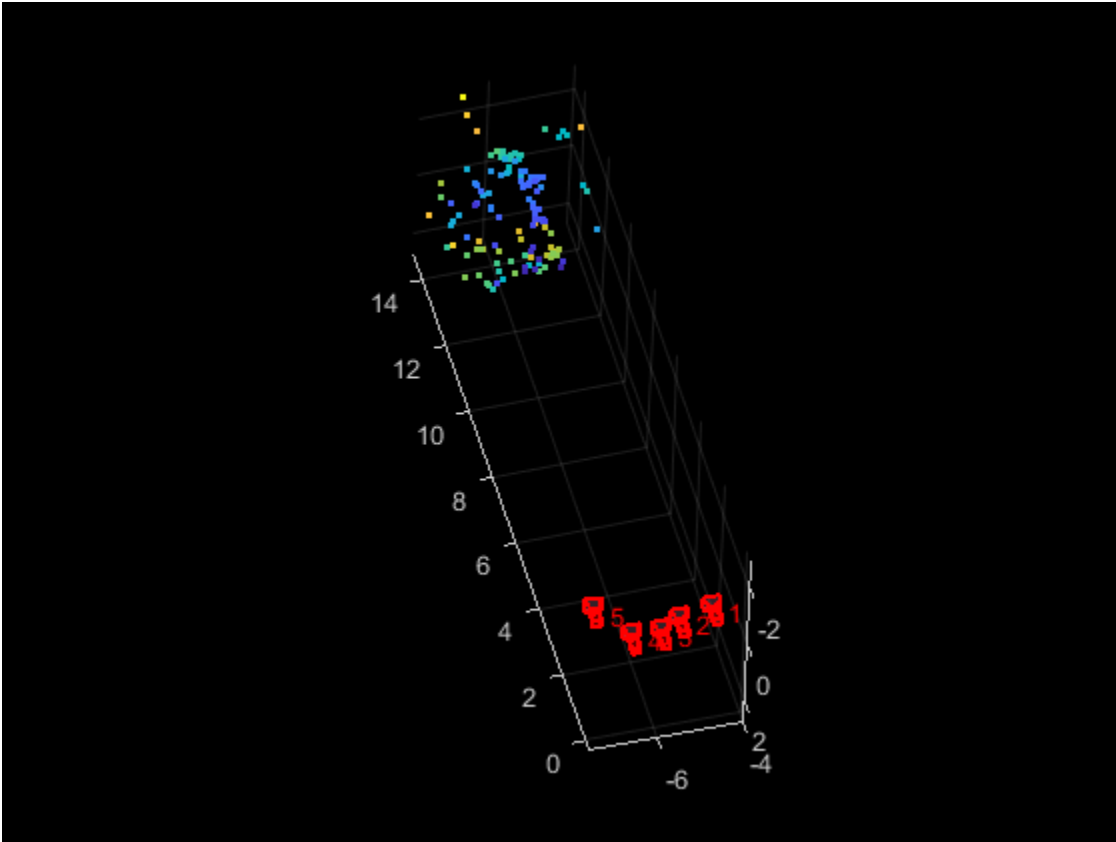

Input Arguments

xyzPoints — Unrefined 3-D points

M-by-3 matrix

Unrefined 3-D points, specified as an *M*-by-3 matrix of $[x,y,z]$ locations.

Data Types: `single` | `double`

pointTracks — Matched points

N-element array of `pointTracks` objects

Matched points across multiple images, specified as an *N*-element array of `pointTracks` objects.

cameraPoses — Camera poses

table

Camera poses, specified as a table containing two columns for 'ViewId' and 'AbsolutePose'. You can get the `cameraPoses` table using the `imageviewset poses` object function.

intrinsics — Camera intrinsics

scalar | *N*-element array of `cameraIntrinsics` objects

Camera intrinsics, specified as a scalar or an *N*-element array of `cameraIntrinsics` objects, where *N* is the height of the `cameraPoses` table. Use a scalar when images are captured using the same camera. Use the *N*-element array when images are captured using different cameras.

Name-Value Pair Arguments

Specify optional comma-separated pairs of `Name`, `Value` arguments. `Name` is the argument name and `Value` is the corresponding value. `Name` must appear inside quotes. You can specify several name and value pair arguments in any order as `Name1, Value1, ..., NameN, ValueN`.

Example: `'MaxIterations', '50'`

MaxIterations — Maximum number of iterations

50 (default) | positive integer

Maximum number of iterations before the Levenberg-Marquardt algorithm stops, specified as the comma-separated pair consisting of `'MaxIterations'` and a positive integer.

AbsoluteTolerance — Absolute termination tolerance

1.0 (default) | positive scalar

Absolute termination tolerance of the mean squared reprojection error in pixels, specified as the comma-separated pair consisting of `'AbsoluteTolerance'` and a positive scalar.

RelativeTolerance — Relative termination tolerance

1e-5 (default) | positive scalar

Relative termination tolerance of the reduction in reprojection error between iterations, specified as the comma-separated pair consisting of `'RelativeTolerance'` and a positive scalar.

PointsUndistorted — Flag to indicate lens distortion

false (default) | true

Flag to indicate lens distortion, specified as the comma-separated pair consisting of `'PointsUndistorted'` and either `false` or `true`. When you set `PointsUndistorted` to `false`, the 2-D points in `pointTracks` must be from images with lens distortion. To use undistorted points, use the `undistortImage` function first, then set `PointsUndistorted` to `true`.

Verbose — Display progress information

false (default) | true

Display progress information, specified as the comma-separated pair consisting of `'Verbose'` and either `false` or `true`.

Output Arguments

xyzRefinedPoints — 3-D locations of refined world points

M -by-3 matrix

3-D locations of refined world points, returned as an M -by-3 matrix of $[x, y, z]$ locations.

Data Types: `single` | `double`

reprojectionErrors — Reprojection errors

M -element vector

Reprojection errors, returned as an M -element vector. The function projects each world point back into each camera. Then in each image, the function calculates the reprojection error as the distance between the detected and the reprojected point. The `reprojectionErrors` vector contains the average reprojection error for each world point.

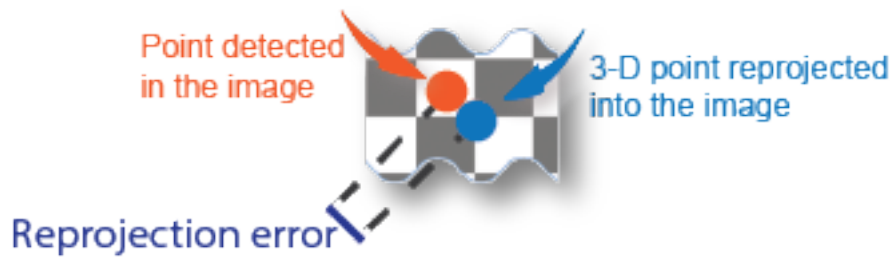

References

- [1] Lourakis, M.I.A. and A.A. Argyros. "SBA: A Software Package for Generic Sparse Bundle Adjustment". *ACM Transactions on Mathematical Software*. Volume 36, Issue 1. March 2009.
- [2] Hartley, R. and A. Zisserman. "Multiple View Geometry in Computer Vision". *Cambridge University Press*. 2003
- [3] Triggs, B., P. McLauchlan, R. Hartley, and A. Fitzgibbon. "Bundle Adjustment: A Modern Synthesis". *Proceedings of the International Workshop on Vision Algorithms: Theory and Practice*. Pages 298 — 372. Springer-Verlag. 1999.

See Also

Objects

`rigid3d` | `imageviewset` | `cameraParameters` | `cameraIntrinsics`

Functions

`bundleAdjustment` | `bundleAdjustmentMotion`

Introduced in R2020a

OCR Trainer

Train an optical character recognition model to recognize a specific set of characters

Description

The **OCR Trainer** app allows you to label character data for OCR training interactively and to generate an OCR language data file for use with the `ocr` function.

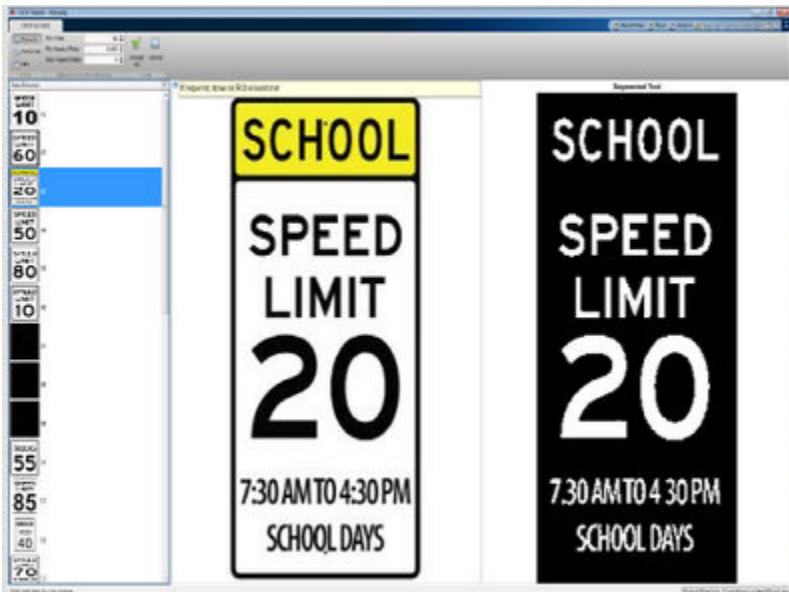

Open the OCR Trainer App

- MATLAB Toolstrip: On the **Apps** tab, under **Image Processing and Computer Vision**, click the app icon.
- MATLAB command prompt: Enter `ocrTrainer`.

Programmatic Use

`ocrTrainer` opens the OCR Trainer app.

`ocrTrainer(sessionFile)` opens the app and loads a saved OCR training session. `sessionFile` is the path to the MAT file containing the saved session.

See Also

`ocr`

Topics

“Train Optical Character Recognition for Custom Fonts”

Introduced in R2016a

listTrueTypeFonts

List available TrueType fonts

Syntax

```
fontNames = listTrueTypeFonts
```

Description

`fontNames = listTrueTypeFonts` returns a cell array of sorted TrueType font names installed on the system.

Use `listTrueTypeFonts` function with the `insertText` function.

Note To display fonts that are available with MATLAB graphics, use the `listfonts` function.

Examples

List Available TrueType Fonts

```
listTrueTypeFonts
ans = 372x1 cell
    {'Agency FB'           }
    {'Agency FB Bold'     }
    {'Algerian'            }
    {'Arial'               }
    {'Arial Black'         }
    {'Arial Bold'          }
    {'Arial Bold Italic'   }
    {'Arial Italic'        }
    {'Arial Narrow'        }
    {'Arial Narrow Bold'   }
    {'Arial Narrow Bold Italic'}
    {'Arial Narrow Italic' }
    {'Arial Rounded MT Bold' }
    {'Bahnschrift'         }
    {'Baskerville Old Face' }
    {'Bauhaus 93'          }
    {'Bell MT'             }
    {'Bell MT Bold'        }
    {'Bell MT Italic'      }
    {'Berlin Sans FB'      }
    {'Berlin Sans FB Bold' }
    {'Berlin Sans FB Demi Bold'}
    {'Bernard MT Condensed' }
    {'Blackadder ITC'       }
    {'Bodoni MT'           }
    {'Bodoni MT Black'     }
    {'Bodoni MT Black Italic' }
```

```
{'Bodoni MT Bold'           }  
{'Bodoni MT Bold Italic'  }  
{'Bodoni MT Condensed'    }  
:  
:
```

List All TrueType 'Lucida' Fonts

```
fontNames = listTrueTypeFonts;  
LucidaFonts = fontNames(~cellfun(@isempty, regexp(fontNames, '^Lucida')))
```

```
LucidaFonts = 21x1 cell  
{'Lucida Bright'           }  
{'Lucida Bright Demibold'  }  
{'Lucida Bright Demibold Italic' }  
{'Lucida Bright Italic'   }  
{'Lucida Calligraphy Italic' }  
{'Lucida Console'         }  
{'Lucida Fax Demibold'    }  
{'Lucida Fax Demibold Italic' }  
{'Lucida Fax Italic'      }  
{'Lucida Fax Regular'     }  
{'Lucida Handwriting Italic' }  
{'Lucida Sans Demibold Italic' }  
{'Lucida Sans Demibold Roman' }  
{'Lucida Sans Italic'     }  
{'Lucida Sans Regular'    }  
{'Lucida Sans Typewriter Bold' }  
{'Lucida Sans Typewriter Bold Oblique' }  
{'Lucida Sans Typewriter Oblique' }  
{'Lucida Sans Typewriter Regular' }  
{'Lucida Sans Unicode'    }  
{'LucidaSansRegular'     }
```

Output Arguments

fontNames — Available TrueType fonts on system

cell array

Available TrueType fonts on system, returned as a cell array of sorted TrueType font names.

See Also

[insertObjectAnnotation](#) | [insertText](#) | [listfonts](#)

Introduced in R2015b

pcfromkinect

Point cloud from Kinect for Windows

Syntax

```
ptCloud = pcfromkinect(depthDevice,depthImage)
ptCloud = pcfromkinect(depthDevice,depthImage,colorImage)
ptCloud = pcfromkinect(depthDevice,depthImage,colorImage,alignment)
```

Description

`ptCloud = pcfromkinect(depthDevice,depthImage)` returns a point cloud from a Kinect depth image. The `depthDevice` input can be either a `videoinput` object or an `imaq.VideoDevice` object configured for Kinect (Versions 1 and 2) for Windows.

This function requires the Image Acquisition Toolbox™ software, which supports Kinect for Windows.

`ptCloud = pcfromkinect(depthDevice,depthImage,colorImage)` adds color to the returned point cloud, specified by the `colorImage` input.

The Kinect for Windows system, designed for gaming, produces `depthImage` and `colorImage` as mirror images of the scene. The returned point cloud is corrected to match the actual scene.

`ptCloud = pcfromkinect(depthDevice,depthImage,colorImage,alignment)` additionally returns the color point cloud with the origin specified at the center of the depth camera.

Examples

Plot Color Point Cloud from Kinect for Windows

Plot a color point cloud from Kinect images. This example requires the Image Acquisition Toolbox software and the Kinect camera and a connection to the camera.

Create a System object for the color device.

```
colorDevice = imaq.VideoDevice('kinect',1)
```

Create a System object for the depth device.

```
depthDevice = imaq.VideoDevice('kinect',2)
```

Initialize the camera.

```
step(colorDevice);
step(depthDevice);
```

Load one frame from the device.

```
colorImage = step(colorDevice);
depthImage = step(depthDevice);
```

Extract the point cloud.

```
ptCloud = pcfromkinect(depthDevice,depthImage,colorImage);
```

Initialize a point cloud player to visualize 3-D point cloud data. The axis is set appropriately to visualize the point cloud from Kinect.

```
player = pcplayer(ptCloud.XLimits,ptCloud.YLimits,ptCloud.ZLimits,...  
    'VerticalAxis','y','VerticalAxisDir','down');  
  
xlabel(player.Axes,'X (m)');  
ylabel(player.Axes,'Y (m)');  
zlabel(player.Axes,'Z (m)');
```

Acquire and view 500 frames of live Kinect point cloud data.

```
for i = 1:500  
    colorImage = step(colorDevice);  
    depthImage = step(depthDevice);  
  
    ptCloud = pcfromkinect(depthDevice,depthImage,colorImage);  
  
    view(player,ptCloud);  
end
```

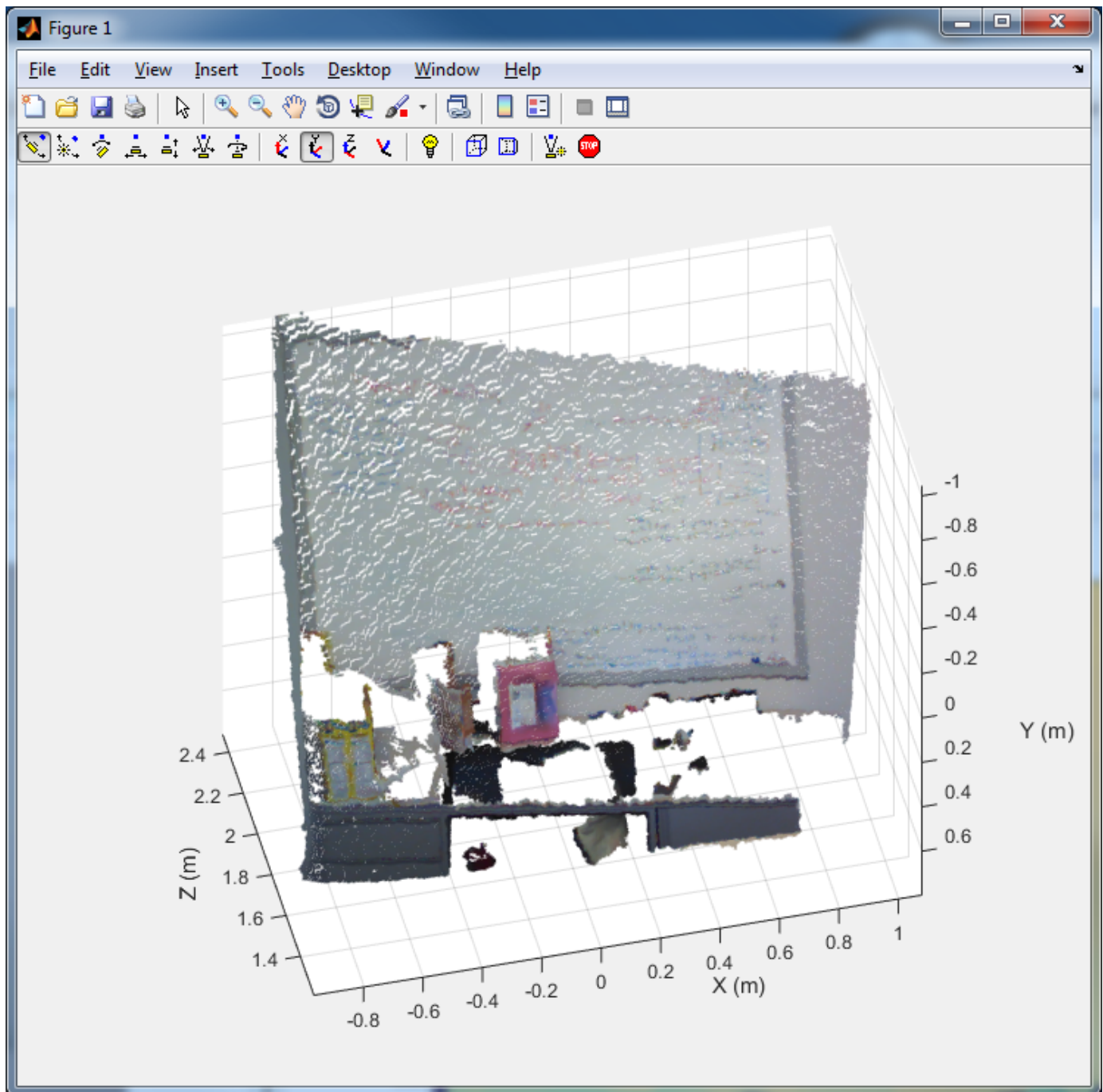

Release the objects.

```
release(colorDevice);  
release(depthDevice);
```

Input Arguments

depthDevice — Input video object

videoinput object | imaq.VideoDevice object

Input video object, specified as either a videoinput object or an imaq.VideoDevice object configured for Kinect for Windows.

depthImage — Depth image

M-by-*N* matrix

Depth image, specified as an *M*-by-*N* pixel matrix. The original images, depthImage and colorImage, from Kinect are mirror images of the scene.

The Kinect depth camera has limited range. The limited range of the Kinect depth camera can cause pixel values in the depth image to not have corresponding 3-D coordinates. These missing pixel values are set to NaN in the Location property of the returned point cloud.

Data Types: uint16

colorImage — Color image

M-by-*N*-by-3 RGB truecolor image

Color image, specified as an *M*-by-*N*-by-3 RGB truecolor image that the Kinect returns. The original images, depthImage and colorImage, from Kinect are mirror images of the scene.

Data Types: uint8

alignment — Direction of the image coordinate system

'colorCentric' (default) | 'depthCentric'

Direction of the image coordinate system, specified as the character vector 'colorCentric' or 'depthCentric'. Set this value to 'colorCentric' to align depthImage with colorImage. Set alignment to 'depthCentric' to align colorImage with depthImage.

The origin of a right-handed world coordinate system is at the center of the depth camera. The *x*-axis of the coordinate system points to the right, the *y*-axis points downward, and the *z*-axis points from the camera.

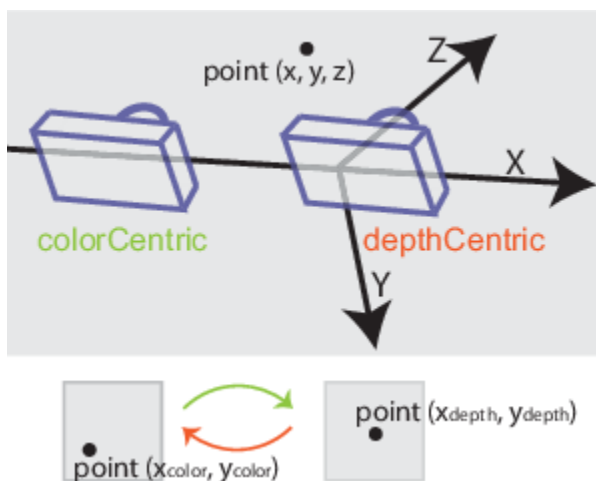

Note For consistency across Computer Vision Toolbox use of coordinates systems, the coordinate system defined by this function is different from the one defined by Kinect Skeletal metadata.

Output Arguments

ptCloud — Point cloud

pointCloud object

Point cloud, returned as a `pointCloud` object. The origin of the coordinate system of the returned point cloud is at the center of the depth camera.

See Also

`pointCloud` | `pcplayer` | `planeModel` | `plot3` | `pcwrite` | `pcread` | `pcshow` | `pcmerge` | `scatter3` | `reconstructScene` | `triangulate` | `pcdownsample` | `pcfitplane` | `pcdenoise` | `pcregistericp`

Topics

“Structure From Motion From Two Views”

“Depth Estimation From Stereo Video”

“Coordinate Systems”

Introduced in R2015b

Camera Calibrator

Estimate geometric parameters of a single camera

Description

The **Camera Calibrator** app allows you to estimate camera intrinsics, extrinsics, and lens distortion parameters. You can use these camera parameters for various computer vision applications. These applications include removing the effects of lens distortion from an image, measuring planar objects, or reconstructing 3-D scenes from multiple cameras.

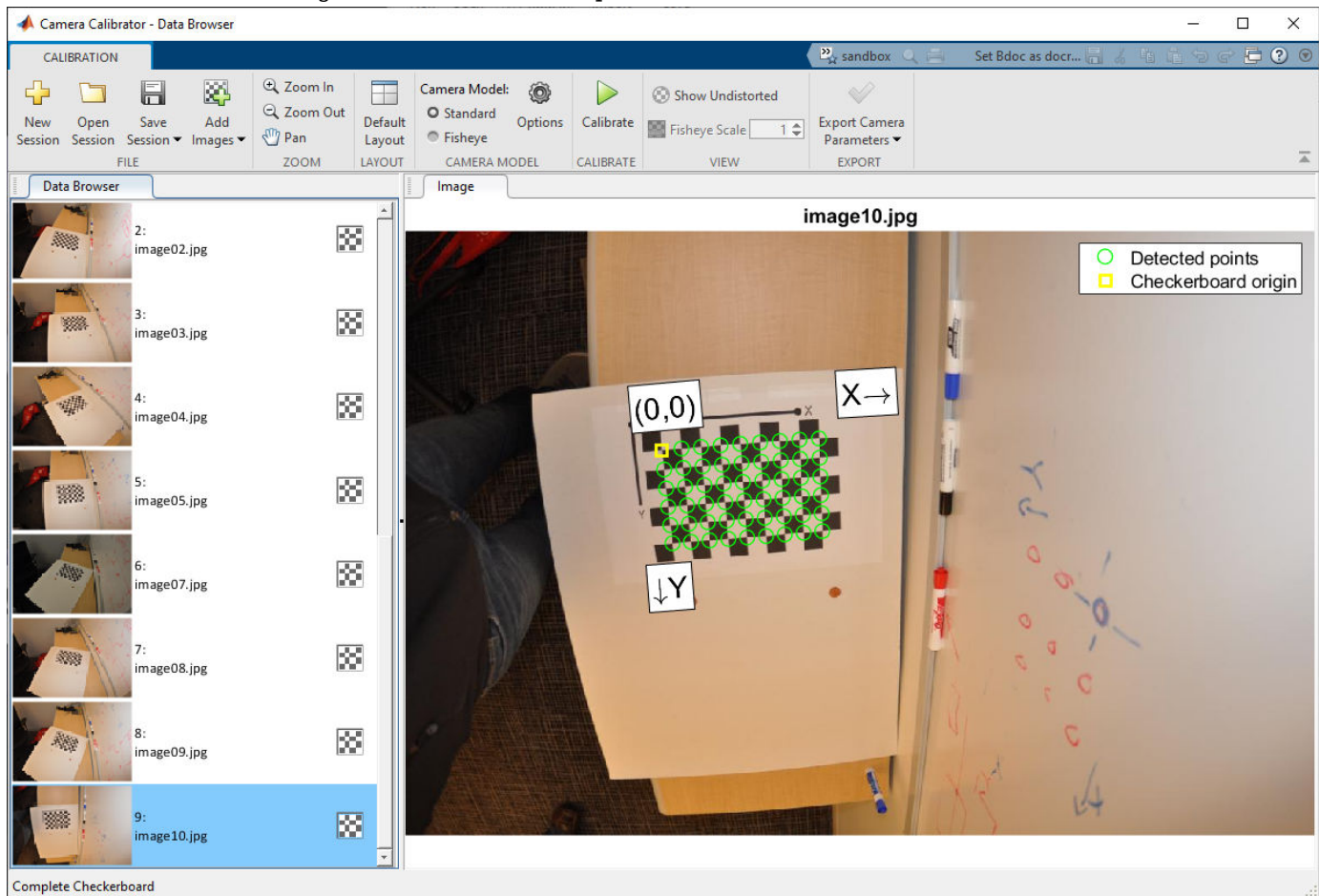

Open the Camera Calibrator App

- MATLAB Toolstrip: On the **Apps** tab, under **Image Processing and Computer Vision**, click the app icon.
- MATLAB command prompt: Enter `cameraCalibrator`.

Examples

Open Camera Calibrator App

This example shows you the two ways to open the Camera Calibrator app.

Type `cameraCalibrator` on the MATLAB command line or select it from the MATLAB desktop **Apps** tab.

- “Evaluating the Accuracy of Single Camera Calibration”
- “Measuring Planar Objects with a Calibrated Camera”
- “Structure From Motion From Two Views”
- “Structure From Motion From Multiple Views”
- “Depth Estimation From Stereo Video”

Programmatic Use

`cameraCalibrator` opens the Camera Calibrator app, which enables you to compute parameters needed to remove the effects of lens distortion from an image.

`cameraCalibrator(imageFolder, squareSize)` opens the app and loads calibration images from a specified folder and specifies the size of the checkerboard squares contained in the images. The `squareSize` input must be a scalar in millimeters.

`cameraCalibrator(imageFolder, squareSize, squareSizeUnits)` opens the app, loads calibration images, specifies the checkerboard square size, and the square size units. The `squareSizeUnits` input must be specified as 'millimeters' (default), 'centimeters', or 'inches'.

`cameraCalibrator(____, highDistortion)` opens the app as described by previous syntaxes and additionally specifies a high distortion logical `highDistortion`. Set `highDistortion` to `true` when the images contain a high level of distortion, which is typical of a wide field of view camera. Set `highDistortion` to `false` (default) when the images do not contain a high level of distortion.

`cameraCalibrator(sessionFile)` opens the app and loads a saved camera calibration session. Set the `sessionFile` to the name of the saved session file. The name must include the path to the MAT file containing the saved session.

See Also

Apps

Stereo Camera Calibrator

Classes

`cameraParameters` | `stereoParameters`

Functions

`estimateCameraParameters` | `showExtrinsics` | `showReprojectionErrors` | `undistortImage` | `detectCheckerboardPoints` | `generateCheckerboardPoints` | `rectifyStereoImages` | `extrinsics` | `triangulate`

Topics

“Evaluating the Accuracy of Single Camera Calibration”

"Measuring Planar Objects with a Calibrated Camera"

"Structure From Motion From Two Views"

"Structure From Motion From Multiple Views"

"Depth Estimation From Stereo Video"

"What Is Camera Calibration?"

"Using the Single Camera Calibrator App"

"Using the Stereo Camera Calibrator App"

Introduced in R2013b

Stereo Camera Calibrator

Estimate geometric parameters of a stereo camera

Description

The **Stereo Camera Calibrator** app allows you to estimate the intrinsic and extrinsic parameters of each camera in a stereo pair. You can also use the app to estimate the translation and rotation between the two cameras.

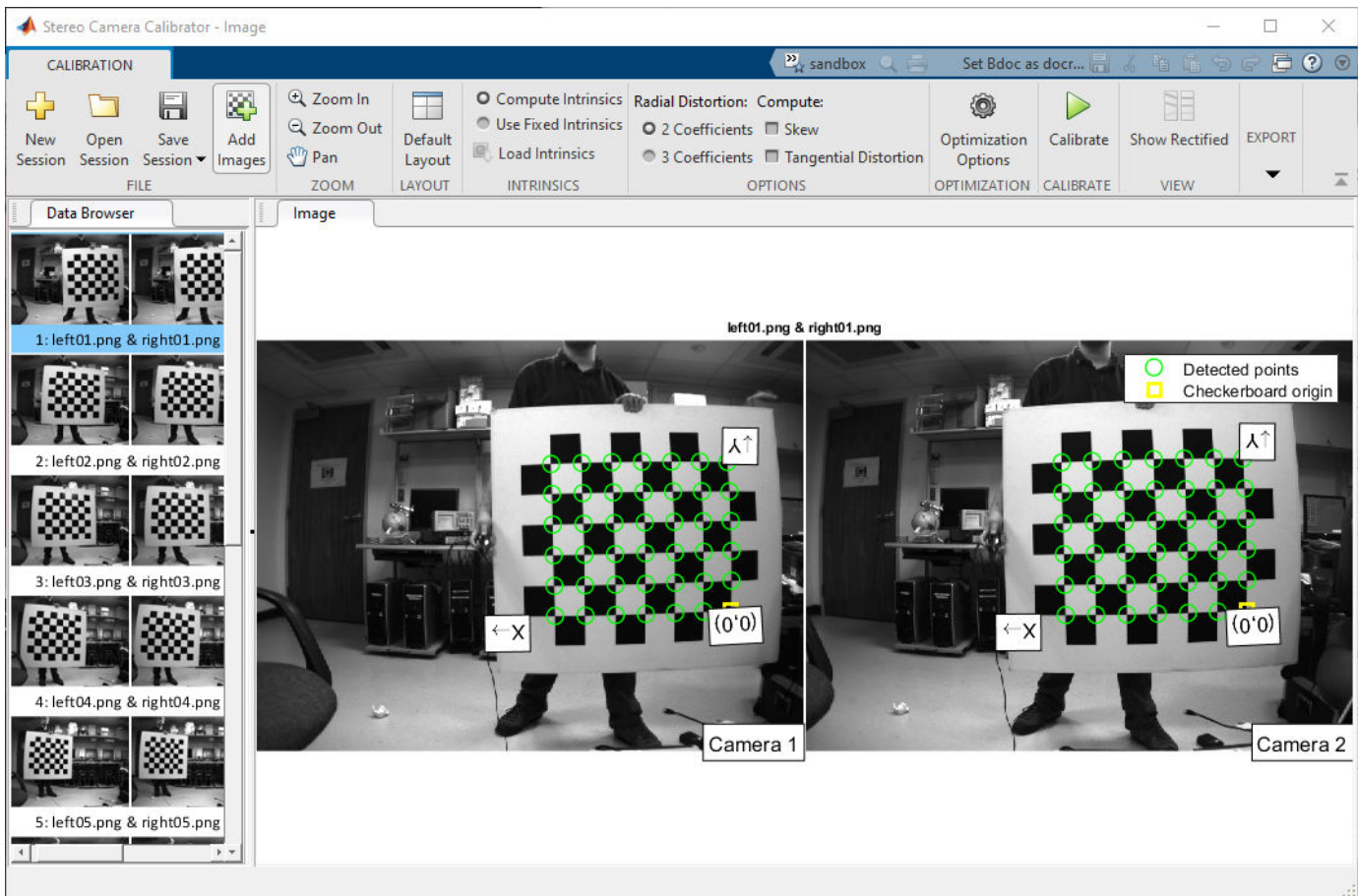

Open the Stereo Camera Calibrator App

- MATLAB Toolstrip: On the **Apps** tab, under **Image Processing and Computer Vision**, click the app icon.
- MATLAB command prompt: Enter `stereoCameraCalibrator`.

Examples

Open Stereo Camera Calibrator App

This example shows you the two ways to open the Stereo Camera Calibrator app.

Type `stereoCameraCalibrator` on the MATLAB command line or select it from the MATLAB desktop **Apps** tab.

- “Evaluating the Accuracy of Single Camera Calibration”
- “Measuring Planar Objects with a Calibrated Camera”
- “Structure From Motion From Two Views”
- “Structure From Motion From Multiple Views”
- “Depth Estimation From Stereo Video”

Programmatic Use

`stereoCameraCalibrator` opens the Stereo Camera Calibrator app. You can use this app to estimate the intrinsic and extrinsic parameters of each camera in a stereo pair. You can also use the app to estimate the translation and rotation between the two cameras.

`stereoCameraCalibrator(folder1, folder2, squareSize)` opens the Stereo Camera Calibrator app and loads the stereo calibration images. The app uses the checkerboard square size specified by the `squareSize` input. It also uses `folder1` images for camera 1 and `folder2` for camera 2.

`stereoCameraCalibrator(folder1, folder2, squareSize, squareSizeUnits)` additionally specifies the units of the square size. If you do not specify units, the app sets `squareSizeUnits` to `'millimeters'`. Units can be `'millimeters'`, `'centimeters'`, or `'inches'`.

`stereoCameraCalibrator(sessionFile)` opens the app and loads a saved stereo calibration session. Set the `sessionFile` to the name of the saved session MAT-file.

See Also

Camera Calibrator | `estimateCameraParameters` | `showExtrinsics` | `showReprojectionErrors` | `undistortImage` | `detectCheckerboardPoints` | `generateCheckerboardPoints` | `cameraParameters` | `stereoParameters`

Topics

- “Evaluating the Accuracy of Single Camera Calibration”
- “Measuring Planar Objects with a Calibrated Camera”
- “Structure From Motion From Two Views”
- “Structure From Motion From Multiple Views”
- “Depth Estimation From Stereo Video”
- “What Is Camera Calibration?”
- “Using the Single Camera Calibrator App”
- “Using the Stereo Camera Calibrator App”

Introduced in R2014b

cameraMatrix

Camera projection matrix

Syntax

```
camMatrix = cameraMatrix(cameraParams,tform)
camMatrix = cameraMatrix(cameraParams,rotationMatrix,translationVector)
```

Description

`camMatrix = cameraMatrix(cameraParams,tform)` returns a 4-by-3 camera projection matrix `camMatrix`, which can be used to project a 3-D world point in homogeneous coordinates into an image. `cameraParams` can be a `cameraParameters` object or a `cameraIntrinsics` object.

`camMatrix = cameraMatrix(cameraParams,rotationMatrix,translationVector)` returns a 4-by-3 camera projection matrix. You can use this matrix to project 3-D world points in homogeneous coordinates into an image.

Examples

Compute Camera Matrix

Create a set of calibration images.

```
images = imageDatastore(fullfile(toolboxdir('vision'),'visiondata', ...
    'calibration','slr'));
```

Detect the checkerboard corners in the images.

```
[imagePoints,boardSize] = detectCheckerboardPoints(images.Files);
```

Generate the world coordinates of the checkerboard corners in the pattern-centric coordinate system, with the upper-left corner at (0,0). The square size is in millimeters.

```
squareSize = 29;
worldPoints = generateCheckerboardPoints(boardSize,squareSize);
```

Calibrate the camera.

```
I = readimage(images,1);
imageSize = [size(I,1),size(I,2)];
cameraParams = estimateCameraParameters(imagePoints,worldPoints, ...
    'ImageSize',imageSize);
```

Load image at new location.

```
imOrig = imread(fullfile(matlabroot,'toolbox','vision','visiondata', ...
    'calibration','slr','image9.jpg'));
figure; imshow(imOrig);
title('Input Image');
```

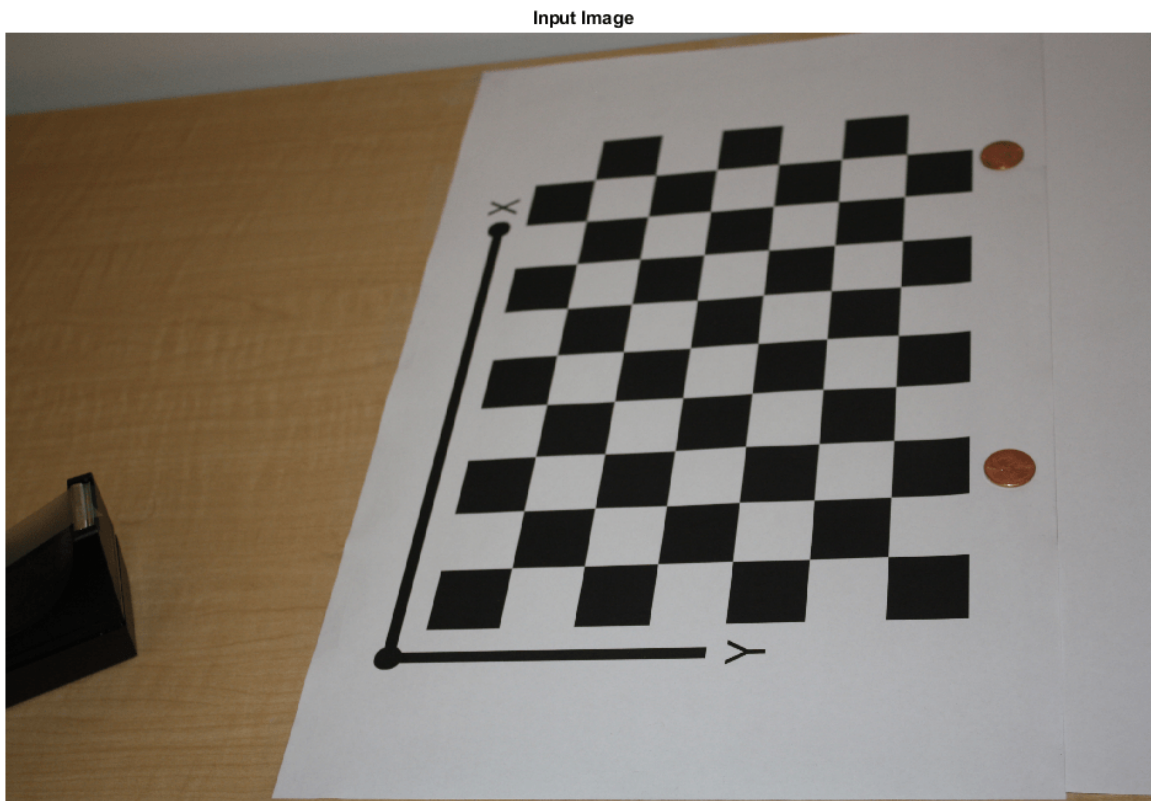

Undistort image.

```
im = undistortImage(imOrig, cameraParams);
```

Find reference object in new image.

```
[imagePoints, boardSize] = detectCheckerboardPoints(im);
```

Compute new extrinsics.

```
[rotationMatrix, translationVector] = extrinsics(...  
    imagePoints, worldPoints, cameraParams);
```

Calculate camera matrix

```
P = cameraMatrix(cameraParams, rotationMatrix, translationVector)
```

```
P = 4x3  
105 x
```

```
0.0157   -0.0271   0.0000  
0.0404   -0.0046  -0.0000  
0.0199    0.0387   0.0000  
8.9399    9.4399    0.0072
```

Input Arguments

cameraParams — Object for storing camera parameters

cameraParameters object | cameraIntrinsics object

Camera parameters, specified as a cameraParameters or cameraIntrinsics object. You can return the cameraParameters object using the estimateCameraParameters function. The cameraParameters object contains the intrinsic, extrinsic, and lens distortion parameters of a camera.

tform — Transformation

rigid3d object

Transformation from world coordinates to camera coordinates, specified as a rigid3d object. You can use the extrinsics function to obtain the rotation and translation to create the tform object.

rotationMatrix — Rotation of camera

3-by-3 matrix

Rotation of camera, specified as a 3-by-3 matrix. You can obtain this matrix using the extrinsics function. You can also obtain the matrix using the relativeCameraPose function by transposing its orientation output. The rotationMatrix and translationVector inputs must be real, nonsparse, and of the same class.

translationVector — Translation of camera

1-by-3 vector

Translation of camera, specified as a 1-by-3 vector. The translation vector describes the transformation from the world coordinates to the camera coordinates. You can obtain this vector using the extrinsics function. You can also obtain the vector using the location and orientation outputs of the relativeCameraPose function:

- `translationVector = -relativeLocation * relativeOrientation'`

The translationVector inputs must be real, nonsparse, and of the same class.

Output Arguments

camMatrix — Camera projection matrix

4-by-3 matrix

Camera projection matrix, returned as a 4-by-3 matrix. The matrix contains the 3-D world points in homogenous coordinates that are projected into the image. When you set rotationMatrix and translationVector to double, the function returns camMatrix as double. Otherwise it returns camMatrix as single.

The function computes camMatrix as follows:

$$\text{camMatrix} = [\text{rotationMatrix}; \text{translationVector}] \times K.$$

K : the intrinsic matrix

Then, using the camera matrix and homogeneous coordinates, you can project a world point onto the image.

$w \times [x,y,1] = [X,Y,Z,1] \times \text{camMatrix}$.

(X,Y,Z): world coordinates of a point

(x,y): coordinates of the corresponding image point

w: arbitrary scale factor

Data Types: `single` | `double`

Extended Capabilities

C/C++ Code Generation

Generate C and C++ code using MATLAB® Coder™.

Usage notes and limitations:

- Use in a MATLAB Function block is not supported.

See Also

Apps

Camera Calibrator | **Stereo Camera Calibrator**

Functions

`extrinsics` | `triangulate` | `estimateCameraParameters` | `relativeCameraPose` | `estimateCameraMatrix`

Topics

“Evaluating the Accuracy of Single Camera Calibration”

“Structure From Motion From Two Views”

“Structure From Motion From Multiple Views”

“Depth Estimation From Stereo Video”

“Code Generation for Depth Estimation From Stereo Video”

“What Is Camera Calibration?”

“Using the Single Camera Calibrator App”

“Using the Stereo Camera Calibrator App”

Introduced in R2014b

cameraPose

Compute relative rotation and translation between camera poses

Syntax

cameraPose

Description

cameraPose returns the camera extrinsics.

Note cameraPose was renamed to `relativeCameraPose`. Please use the new function in place of cameraPose.

Extended Capabilities

C/C++ Code Generation

Generate C and C++ code using MATLAB® Coder™.

Usage notes and limitations:

- Use in a MATLAB Function block is not supported.

Introduced in R2015b

relativeCameraPose

Compute relative rotation and translation between camera poses

Syntax

```
[relativeOrientation,relativeLocation] = relativeCameraPose(M, cameraParams,
inlierPoints1,inlierPoints2)
[relativeOrientation,relativeLocation] = relativeCameraPose(M, cameraParams1,
cameraParams2,inlierPoints1,inlierPoints2)
[relativeOrientation,relativeLocation,validPointsFraction] =
relativeCameraPose(M, ___)
```

Description

[relativeOrientation,relativeLocation] = relativeCameraPose(M,cameraParams, inlierPoints1,inlierPoints2) returns the orientation and location of a calibrated camera relative to its previous pose. The two poses are related by M, which must be a fundamental, essential, affine2d, or projective2d matrix. The function computes the camera location up to scale and returns relativeLocation as a unit vector.

[relativeOrientation,relativeLocation] = relativeCameraPose(M,cameraParams1, cameraParams2,inlierPoints1,inlierPoints2) returns the orientation and location of the second camera relative to the first one.

[relativeOrientation,relativeLocation,validPointsFraction] = relativeCameraPose(M, ___) additionally returns the fraction of the inlier points that project in front of both cameras.

Input Arguments

M — Fundamental, essential, or homography matrix

3-by-3 matrix

Fundamental, essential matrix, or a homography matrix, specified as a 3-by-3 matrix, an affine2d object, or a projective2d object containing a homography matrix. You can obtain the 3-by-3 matrix using one of the following functions:

- estimateFundamentalMatrix for the fundamental matrix.
- estimateEssentialMatrix for the essential matrix
- estimateGeometricTransform for the projective or affine 2-D object.

Data Types: single | double

cameraParams — Object for storing camera parameters

cameraParameters object | cameraIntrinsics object

Camera parameters, specified as a cameraParameters or cameraIntrinsics object. You can return the cameraParameters object using the estimateCameraParameters function. The

cameraParameters object contains the intrinsic, extrinsic, and lens distortion parameters of a camera.

cameraParams1 — Camera parameters for camera 1

cameraParameters object | cameraIntrinsics object

Camera parameters for camera 1, specified as a cameraParameters or cameraIntrinsics object. You can return the cameraParameters object using the estimateCameraParameters function. The cameraParameters object contains the intrinsic, extrinsic, and lens distortion parameters of a camera.

cameraParams2 — Camera parameters for camera 2

cameraParameters object | cameraIntrinsics object

Camera parameters for camera 2, specified as a cameraParameters or cameraIntrinsics object. You can return the cameraParameters object using the estimateCameraParameters function. The cameraParameters object contains the intrinsic, extrinsic, and lens distortion parameters of a camera.

inlierPoints1 — Coordinates of corresponding points in view 1

SIFTPoints | SURFPoints | cornerPoints | MSERRegions | M -by-2 matrix of $[x,y]$ coordinates

Coordinates of corresponding points in view 1, specified as an M -by-2 matrix of M number of $[x,y]$ coordinates, or as a SIFTPoints, SURFPoints, MSERRegions, or cornerPoints object. You can obtain these points using the estimateFundamentalMatrix function or the estimateEssentialMatrix.

inlierPoints2 — Coordinates of corresponding points in view 2

SIFTPoints | SURFPoints | cornerPoints | MSERRegions | M -by-2 matrix of $[x,y]$ coordinates

Coordinates of corresponding points in view 2, specified as an M -by-2 matrix of M number of $[x,y]$ coordinates, or as a SIFTPoints, SURFPoints, MSERRegions, or cornerPoints object. You can obtain these points using the estimateFundamentalMatrix function or the estimateEssentialMatrix.

Output Arguments

relativeOrientation — Orientation of camera

3-by-3 matrix

Orientation of camera, returned as a 3-by-3 matrix. If you use only one camera, the matrix describes the orientation of the second camera pose relative to the first camera pose. If you use two cameras, the matrix describes the orientation of camera 2 relative to camera 1.

Data Types: single | double

relativeLocation — Location of camera

1-by-3 vector

Location of camera, returned as a 1-by-3 unit vector. If you use only one camera, the vector describes the location of the second camera pose relative to the first camera pose. If you use two cameras, the vector describes the location of camera 2 relative to camera 1.

Data Types: single | double

validPointsFraction — Fraction of valid inlier points

scalar

Fraction of valid inlier points that project in front of both cameras, returned as a scalar. If `validPointsFraction` is too small, e.g. less than 0.9, it can indicate that the fundamental matrix is incorrect.

Tips

- You can compute the camera extrinsics, `rotationMatrix` and `translationVector`, corresponding to the camera pose, from `relativeOrientation` and `relativeLocation`:

```
[rotationMatrix,translationVector] = cameraPoseToExtrinsics(relativeOrientation,relativeLocation)
```

The orientation of the previous camera pose is the identity matrix, `eye(3)`, and its location is, `[0,0,0]`.

- You can then use `rotationMatrix` and `translationVector` as inputs to the `cameraMatrix` function.
- You can compute four possible combinations of orientation and location from the input fundamental matrix. Three of the combinations are not physically realizable, because they project 3-D points behind one or both cameras. The `relativeCameraPose` function uses `inlierPoints1` and `inlierPoints2` to determine the realizable combination.

Extended Capabilities**C/C++ Code Generation**

Generate C and C++ code using MATLAB® Coder™.

Usage notes and limitations:

- Use in a MATLAB Function block is not supported.

See Also**Apps**

Camera Calibrator

Functions

`estimateWorldCameraPose` | `estimateCameraParameters` | `estimateEssentialMatrix` | `estimateFundamentalMatrix` | `cameraMatrix` | `plotCamera` | `triangulate` | `triangulateMultiview` | `cameraPoseToExtrinsics`

Topics

“Structure From Motion From Two Views”

“Structure From Motion From Multiple Views”

“Point Feature Types”

“Using the Single Camera Calibrator App”

“Using the Stereo Camera Calibrator App”

“Structure from Motion Overview”

Introduced in R2016b

estimateCameraMatrix

Estimate camera projection matrix from world-to-image point correspondences

Syntax

```
camMatrix = estimateCameraMatrix(imagePoints,worldPoints)
[camMatrix,reprojectionErrors] = estimateCameraMatrix(imagePoints,
worldPoints)
```

Description

`camMatrix = estimateCameraMatrix(imagePoints,worldPoints)` returns the camera projection matrix determined from known world points and their corresponding image projections by using the direct linear transformation (DLT) approach.

`[camMatrix,reprojectionErrors] = estimateCameraMatrix(imagePoints,worldPoints)` also returns the reprojection error that quantifies the accuracy of the projected image coordinates.

Examples

Estimate Camera Projection Matrix

Load a 3-D point cloud data captured by an RGB-D sensor into the workspace.

```
ld = load('object3d.mat');
ptCloud = ld.ptCloud;
```

Remove points with Inf or NaN coordinates from the point cloud.

```
[validPtCloud,validIndices] = removeInvalidPoints(ptCloud);
```

Read the valid world point coordinates. Each entry specifies the x, y, z coordinates of a point in the point cloud.

```
worldPoints = validPtCloud.Location;
```

Define the corresponding image point coordinates as a orthographic projection of point cloud data onto the yz-plane.

```
indices = 1:ptCloud.Count;
[y,z] = ind2sub([size(ptCloud.Location,1),size(ptCloud.Location,2)],indices);
imagePoints = [y(validIndices)' z(validIndices)'];
```

Generate the 2-D image projection by using the image point coordinates and their color values.

```
projImage = zeros(max(imagePoints(:,1)),max(imagePoints(:,2)),3);
rgb = validPtCloud.Color;
for j = 1:length(rgb)
projImage(imagePoints(j,1),imagePoints(j,2),:) = rgb(j,:);
end
```

Display the point cloud data and the corresponding 2-D image projection.

```
figure
subplot(1,2,1)
pcshow(ptCloud)
xlabel('X');
ylabel('Y');
zlabel('Z');
title('Point Cloud Data','Color',[1 1 1])
subplot(1,2,2)
imshow(uint8(projImage))
title('2-D Image Projection','Color',[1 1 1])
```

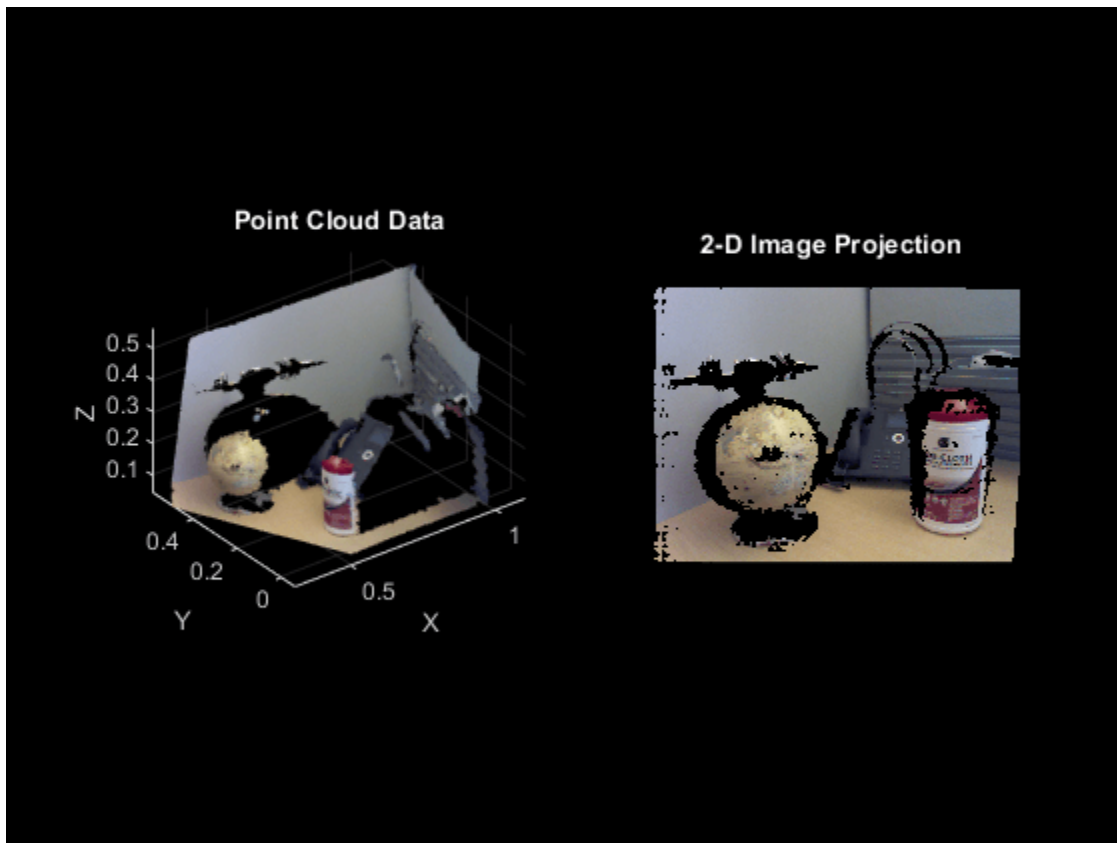

Estimate the camera projection matrix and reprojection error by using the known world points and the image points.

```
[camMatrix,reprojectionErrors] = estimateCameraMatrix(imagePoints,worldPoints);
```

Use the estimated camera projection matrix as input to the `findNearestNeighbors` function and find the nearest neighbors of a query point.

```
point = [0.4 0.3 0.2]; % Specify the query point
K = 50; % Specify the number of nearest neighbors to be determined
[indices,dists] = findNearestNeighbors(ptCloud,point,K,camMatrix); % Get the indices and distances
```

Use the `select` function to get the point cloud data of nearest neighbors.

```
ptCloudB = select(ptCloud,indices);
```

Display the input point cloud and its nearest neighbors.

```
figure,
pcshow(ptCloud)
hold on
pcshow(ptCloudB.Location,'ob')
hold off
legend('Point Cloud','Nearest Neighbors','Location','southoutside','Color',[1 1 1])
```

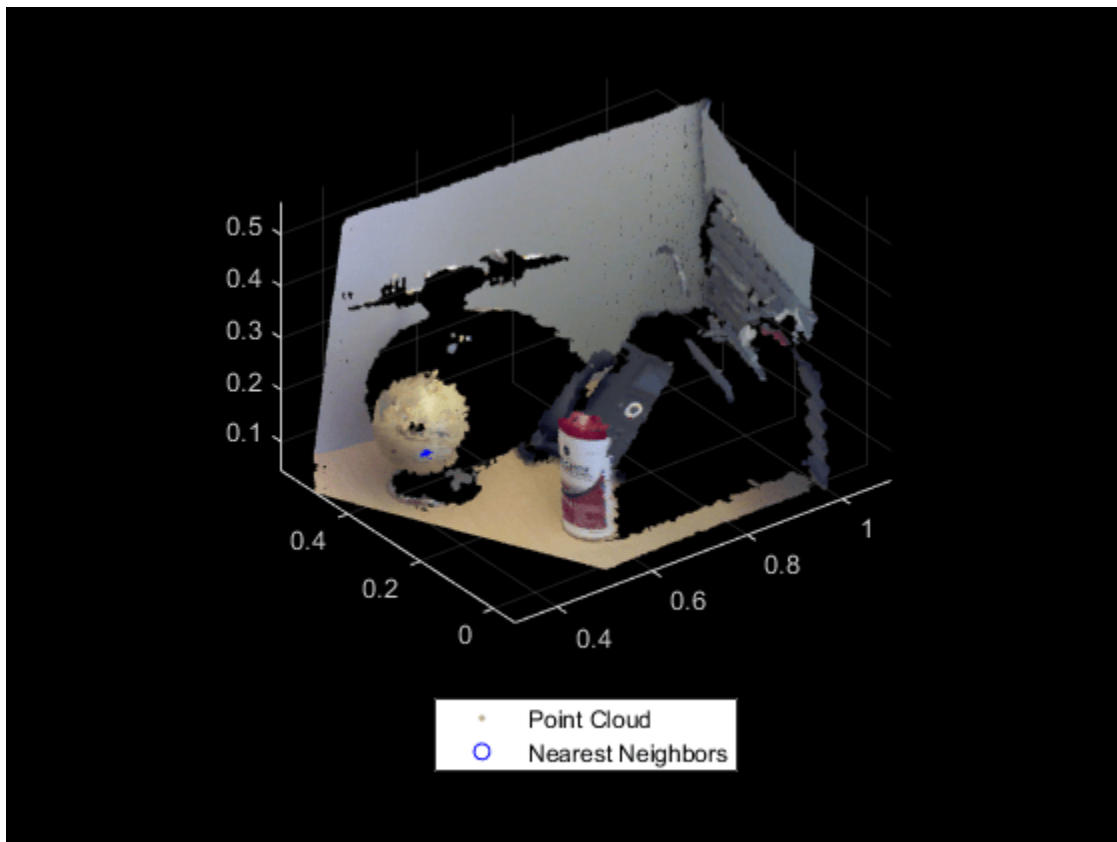

Input Arguments

imagePoints — Coordinates of image projection points

M -by-2 matrix of (x, y) coordinates

Coordinates of image projection points, specified as an M -by-2 matrix of (x, y) coordinates. M is the number of points and it must be greater than or equal to 6.

Note

- The input image points must correspond to an undistorted image plane.
-

Data Types: single | double

worldPoints — 3-D world points

M-by-3 matrix of (*x*, *y*, *z*) coordinates

3-D world points, specified as an *M*-by-3 matrix of (*x*, *y*, *z*) coordinates. *M* is the number of points and it must be greater than or equal to 6.

Note

- The input world coordinates must be non-coplanar points.
-

Data Types: `single` | `double`

Output Arguments**camMatrix — Camera projection matrix**

4-by-3 matrix

Camera projection matrix, returned as a 4-by-3 matrix. The matrix maps the 3-D world points, in homogenous coordinates to the 2-D image coordinates of the projections onto the image plane.

Data Types: `double`

reprojectionErrors — Reprojection errors

M-by-1 vector

Reprojection errors, returned as a *M*-by-1 vector. The reprojection error is the error between the reprojected image points and the input image points. For more information on the computation of reprojection errors, see “Algorithms” on page 3-370.

Data Types: `double`

Tips

You can use the `estimateCameraMatrix` function to estimate a camera projection matrix:

- If the world-to-image point correspondences are known, and the camera intrinsics and extrinsics parameters are not known, you can use the `cameraMatrix` function.
- To compute 2-D image points from 3-D world points, refer to the equations in `camMatrix`.
- For use with the `findNearestNeighbors` object function of the `pointCloud` object. The use of a camera projection matrix speeds up the nearest neighbors search in a point cloud generated by an RGB-D sensor, such as Microsoft Kinect.

Algorithms

Given the world points \mathbf{X} and the image points \mathbf{x} , the camera projection matrix C , is obtained by solving the equation

$$\lambda \mathbf{x} = C\mathbf{X}.$$

The equation is solved using the direct linear transformation (DLT) approach [1]. This approach formulates a homogeneous linear system of equations, and the solution is obtained through generalized eigenvalue decomposition.

Because the image point coordinates are given in pixel values, the approach for computing the camera projection matrix is sensitive to numerical errors. To avoid numerical errors, the input image point coordinates are normalized, so that their centroid is at the origin. Also, the root mean squared distance of the image points from the origin is $\sqrt{2}$. These steps summarize the process for estimating the camera projection matrix.

- 1 Normalize the input image point coordinates with transform T .
- 2 Estimate camera projection matrix C^N from the normalized input image points.
- 3 Compute the denormalized camera projection matrix C as $C^N T^{-1}$.
- 4 Compute the reprojected image point coordinates \mathbf{x}^E as $C\mathbf{X}$.
- 5 Compute the reprojection errors as $reprojectionErrors = |\mathbf{x} - \mathbf{x}^E|$.

References

- [1] Richard, H. and A. Zisserman. *Multiple View Geometry in Computer Vision*. Cambridge: Cambridge University Press, 2000.

See Also

Apps

Camera Calibrator | **Stereo Camera Calibrator**

Objects

stereoParameters | cameraCalibrationErrors | intrinsicsEstimationErrors | extrinsicsEstimationErrors | cameraIntrinsics

Functions

estimateCameraParameters | showReprojectionErrors | showExtrinsics | undistortImage | detectCheckerboardPoints | generateCheckerboardPoints | cameraMatrix | estimateWorldCameraPose | estimateEssentialMatrix | estimateFundamentalMatrix | findNearestNeighbors

Topics

"Evaluating the Accuracy of Single Camera Calibration"
 "Structure From Motion From Two Views"
 "Structure From Motion From Multiple Views"
 "Depth Estimation From Stereo Video"
 "Code Generation for Depth Estimation From Stereo Video"
 "What Is Camera Calibration?"
 "Using the Single Camera Calibrator App"
 "Using the Stereo Camera Calibrator App"

Introduced in R2019a

extractLBPFeatures

Extract local binary pattern (LBP) features

Syntax

```
features = extractLBPFeatures(I)  
features = extractLBPFeatures(I,Name,Value)
```

Description

`features = extractLBPFeatures(I)` returns extracted uniform local binary pattern (LBP) from a grayscale image. The LBP features encode local texture information.

`features = extractLBPFeatures(I,Name,Value)` uses additional options specified by one or more `Name,Value` pair arguments.

Examples

Using LBP Features to Differentiate Images by Texture

Read images that contain different textures.

```
brickWall = imread('bricks.jpg');  
rotatedBrickWall = imread('bricksRotated.jpg');  
carpet = imread('carpet.jpg');
```

Display the images.

```
figure  
imshow(brickWall)  
title('Bricks')
```

Bricks

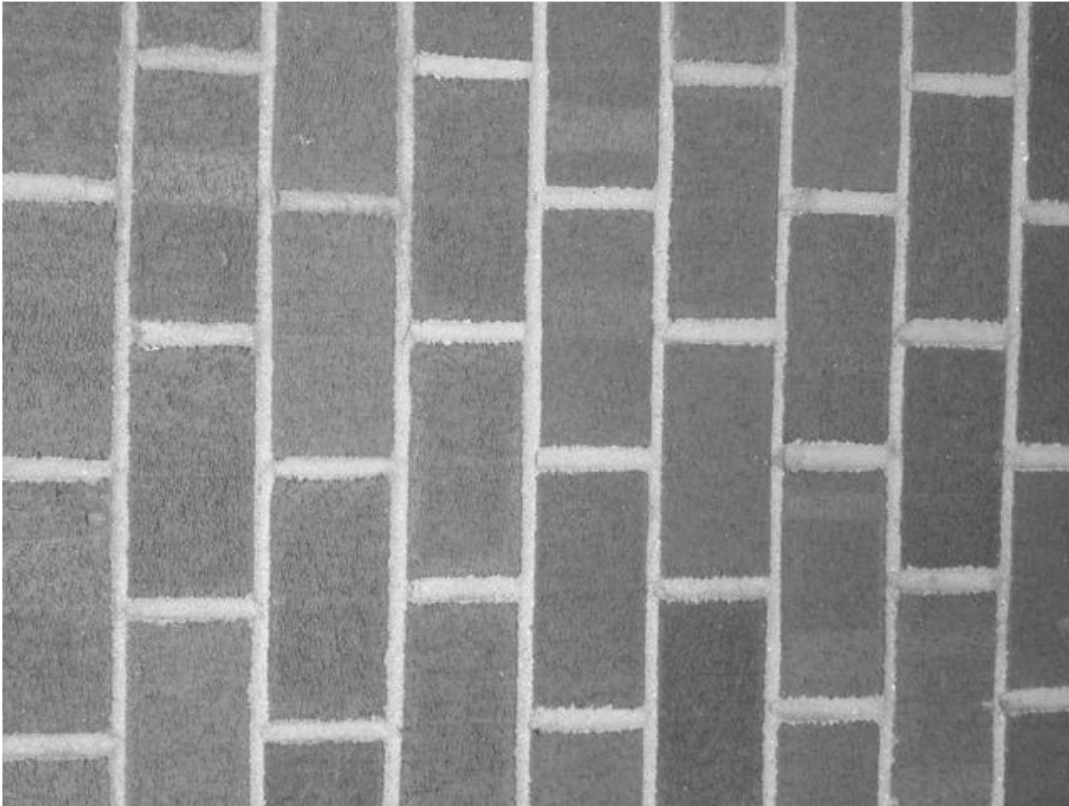

```
figure  
imshow(rotatedBrickWall)  
title('Rotated Bricks')
```

Rotated Bricks

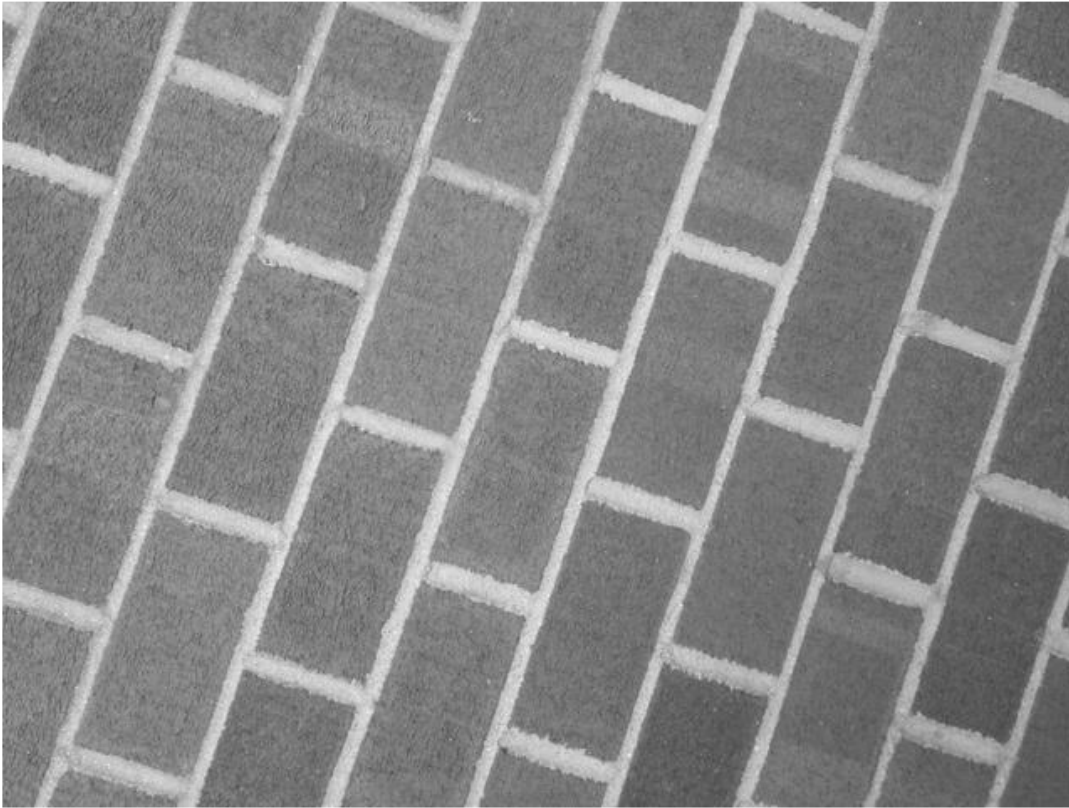

```
figure  
imshow(carpet)  
title('Carpet')
```

Carpet

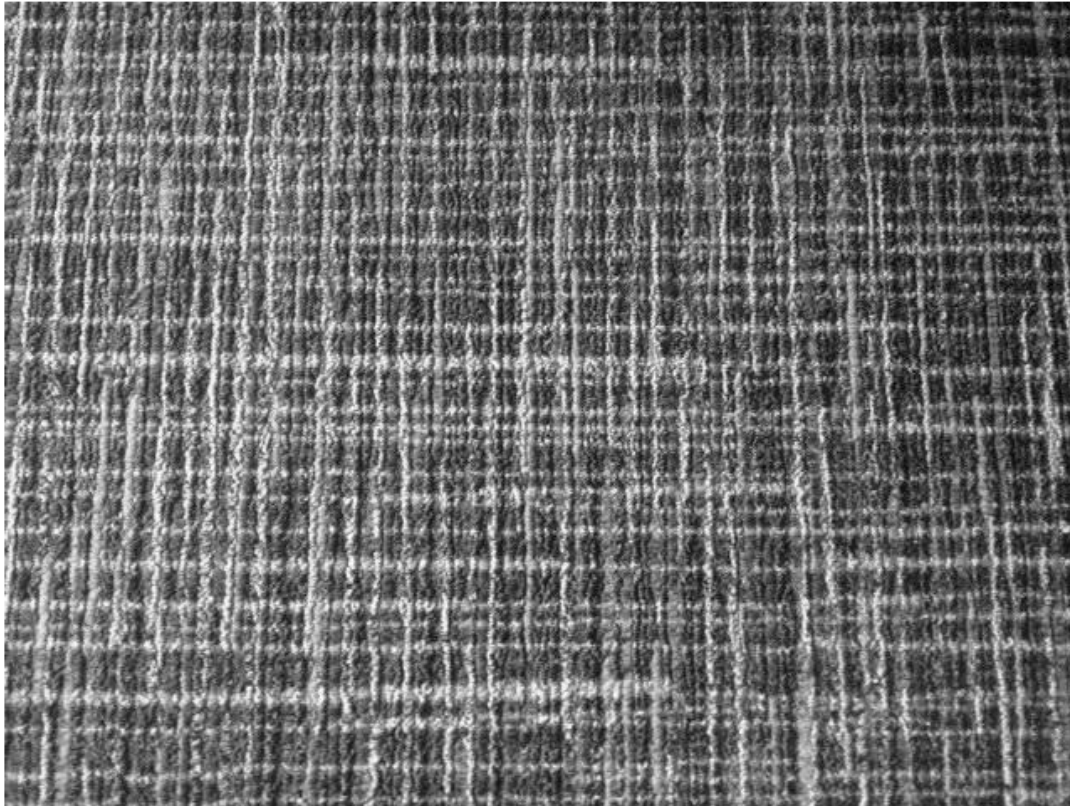

Extract LBP features from the images to encode their texture information.

```
lbpBricks1 = extractLBPFeatures(brickWall, 'Upright', false);
lbpBricks2 = extractLBPFeatures(rotatedBrickWall, 'Upright', false);
lbpCarpet = extractLBPFeatures(carpet, 'Upright', false);
```

Gauge the similarity between the LBP features by computing the squared error between them.

```
brickVsBrick = (lbpBricks1 - lbpBricks2).^2;
brickVsCarpet = (lbpBricks1 - lbpCarpet).^2;
```

Visualize the squared error to compare bricks versus bricks and bricks versus carpet. The squared error is smaller when images have similar texture.

```
figure
bar([brickVsBrick; brickVsCarpet]', 'grouped')
title('Squared Error of LBP Histograms')
xlabel('LBP Histogram Bins')
legend('Bricks vs Rotated Bricks', 'Bricks vs Carpet')
```

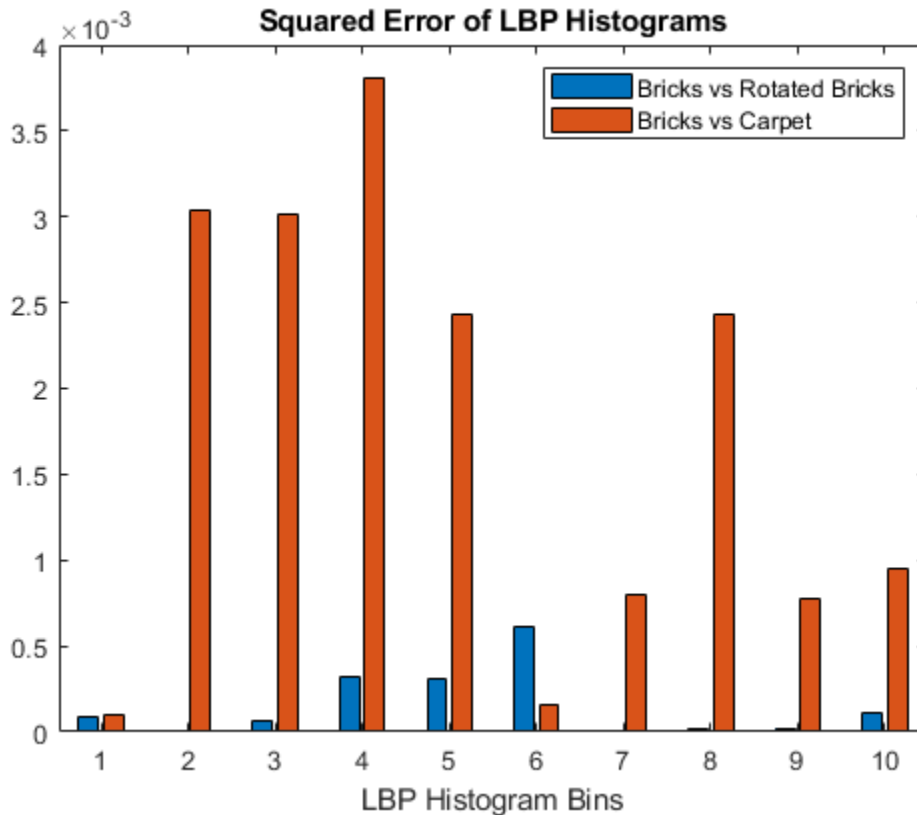

Apply L1 Normalization to LBP Features

Read in a sample image and convert it to grayscale.

```
I = imread('gantrycrane.png');
I = im2gray(I);
```

Extract unnormalized LBP features so that you can apply a custom normalization.

```
lbpFeatures = extractLBPFeatures(I, 'CellSize', [32 32], 'Normalization', 'None');
```

Reshape the LBP features into a *number of neighbors*-by-*number of cells* array to access histograms for each individual cell.

```
numNeighbors = 8;
numBins = numNeighbors*(numNeighbors-1)+3;
lbpCellHists = reshape(lbpFeatures, numBins, []);
```

Normalize each LBP cell histogram using L1 norm.

```
lbpCellHists = bsxfun(@rdivide, lbpCellHists, sum(lbpCellHists));
```

Reshape the LBP features vector back to 1-by-*N* feature vector.

```
lbpFeatures = reshape(lbpCellHists, 1, []);
```

Input Arguments

I — Input image

M-by-*N* 2-D grayscale image

Input image, specified as an *M*-by-*N* 2-D grayscale image that is real, and non-sparse.

Data Types: `logical` | `single` | `double` | `int16` | `uint8` | `uint16`

Name-Value Pair Arguments

Specify optional comma-separated pairs of `Name`, `Value` arguments. `Name` is the argument name and `Value` is the corresponding value. `Name` must appear inside quotes. You can specify several name and value pair arguments in any order as `Name1, Value1, ..., NameN, ValueN`.

Example: `'NumNeighbors',8`

Algorithm Parameters

The LBP algorithm parameters control how local binary patterns are computed for each pixel in the input image.

NumNeighbors — Number of neighbors

8 (default) | positive integer

Number of neighbors used to compute the LBP for each pixel in the input image, specified as the comma-separated pair consisting of `'NumNeighbors'` and a positive integer. The set of neighbors is selected from a circularly symmetric pattern around each pixel. Increase the number of neighbors to encode greater detail around each pixel. Typical values range from 4 to 24.

Radius — Radius of circular pattern to select neighbors

1 (default) | positive integer

Radius of circular pattern used to select neighbors for each pixel in the input image, specified as the comma-separated pair consisting of `'Radius'` and a positive integer. To capture detail over a larger spatial scale, increase the radius. Typical values range from 1 to 5.

Upright — Rotation invariance flag

`true` | logical scalar

Rotation invariance flag, specified as the comma-separated pair consisting of `'Upright'` and a logical scalar. When you set this property to `true`, the LBP features do not encode rotation information. Set `'Upright'` to `false` when rotationally invariant features are required.

Interpolation — Interpolation method

`'Linear'` (default) | `'Nearest'`

Interpolation method used to compute pixel neighbors, specified as the comma-separated pair consisting of `'Interpolation'` and either `'Linear'` or `'Nearest'`. Use `'Nearest'` for faster computation, but with less accuracy.

Histogram Parameters

The histogram parameters determine how the distribution of binary patterns is aggregated over the image to produce the output features.

CellSize – Cell size

`size(I)` (default) | 2-element vector

Cell size, specified as the comma-separated pair consisting of 'CellSize' and a 2-element vector. The number of cells is calculated as `floor(size(I)/CellSize)`.

Normalization – Type of normalization

'L2' (default) | 'None'

Type of normalization applied to each LBP cell histogram, specified as the comma-separated pair consisting of 'Normalization' and either 'L2' or 'None'. To apply a custom normalization method as a post-processing step, set this value to 'None'.

Output Arguments**features – LBP feature vector**

1-by- N vector

LBP feature vector, returned as a 1-by- N vector of length N representing the number of features. LBP features encode local texture information, which you can use for tasks such as classification, detection, and recognition. The function partitions the input image into non-overlapping cells. To collect information over larger regions, select larger cell sizes. However, when you increase the cell size, you lose local detail. N , depends on the number of cells in the image, `numCells`, the number of neighbors, P , and the `Upright` parameter.

The number of cells is calculated as:

`numCells = prod(floor(size(I)/CellSize))`

The figure shows an image with nine cell histograms. Each histogram describes an LBP feature.

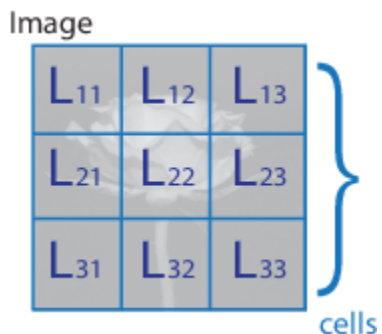

The size of the histogram in each cell is $[1, B]$, where B is the number of bins in the histogram. The number of bins depends on the `Upright` property and the number of neighbors, P .

Upright	Number of Bins
true	$(P \times P - 1) + 3$
false	$(P + 2)$

The overall LBP feature length, N , depends on the number of cells and the number of bins, B :
 $N = \text{numCells} \times B$

LBP features = size(Lyx) = [1, B]

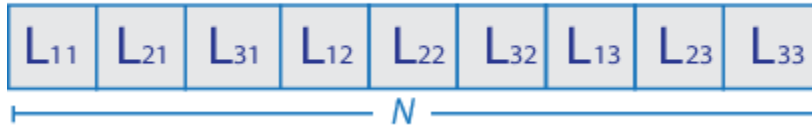

References

- [1] Ojala, T., M. Pietikainen, and T. Maenpaa. "Multiresolution Gray Scale and Rotation Invariant Texture Classification With Local Binary Patterns." *IEEE Transactions on Pattern Analysis and Machine Intelligence*. Vol. 24, Issue 7, July 2002, pp. 971-987.

Extended Capabilities

C/C++ Code Generation

Generate C and C++ code using MATLAB® Coder™.

Usage notes and limitations:

- Does not generate a platform-dependent library.

See Also

[extractHOGFeatures](#) | [extractFeatures](#) | [detectBRISKFeatures](#) | [detectMSERFeatures](#) | [matchFeatures](#) | [detectSURFFeatures](#) | [SURFPoints](#) | [MSERRegions](#) | [detectHarrisFeatures](#) | [detectFASTFeatures](#) | [detectMinEigenFeatures](#)

Topics

"Local Feature Detection and Extraction"

Introduced in R2015b

configureKalmanFilter

Create Kalman filter for object tracking

Syntax

```
kalmanFilter = configureKalmanFilter(MotionModel,InitialLocation,
InitialEstimateError,MotionNoise,MeasurementNoise)
```

Description

`kalmanFilter = configureKalmanFilter(MotionModel,InitialLocation,InitialEstimateError,MotionNoise,MeasurementNoise)` returns a `vision.KalmanFilter` object configured to track a physical object. This object moves with constant velocity or constant acceleration in an M -dimensional Cartesian space. The function determines the number of dimensions, M , from the length of the `InitialLocation` vector.

This function provides a simple approach for configuring the `vision.KalmanFilter` object for tracking a physical object in a Cartesian coordinate system. The tracked object may move with either constant velocity or constant acceleration. The statistics are the same along all dimensions. If you need to configure a Kalman filter with different assumptions, use the `vision.KalmanFilter` object directly.

Examples

Track an Occluded Object

Detect and track a ball using Kalman filtering, foreground detection, and blob analysis.

Create System objects to read the video frames, detect foreground physical objects, and display results.

```
videoReader = VideoReader('singleball.mp4');
videoPlayer = vision.VideoPlayer('Position',[100,100,500,400]);
foregroundDetector = vision.ForegroundDetector('NumTrainingFrames',10,...
    'InitialVariance',0.05);
blobAnalyzer = vision.BlobAnalysis('AreaOutputPort',false,...
    'MinimumBlobArea',70);
```

Process each video frame to detect and track the ball. After reading the current video frame, the example searches for the ball by using background subtraction and blob analysis. When the ball is first detected, the example creates a Kalman filter. The Kalman filter determines the ball's location, whether it is detected or not. If the ball is detected, the Kalman filter first predicts its state at the current video frame. The filter then uses the newly detected location to correct the state, producing a filtered location. If the ball is missing, the Kalman filter solely relies on its previous state to predict the ball's current location.

```
kalmanFilter = []; isTrackInitialized = false;
while hasFrame(videoReader)
    colorImage = readFrame(videoReader);
```

```
foregroundMask = step(foregroundDetector,im2gray(im2single(colorImage)));
detectedLocation = step(blobAnalyzer,foregroundMask);
isObjectDetected = size(detectedLocation, 1) > 0;

if ~isTrackInitialized
    if isObjectDetected
        kalmanFilter = configureKalmanFilter('ConstantAcceleration',...
            detectedLocation(1,:), [1 1 1]*1e5, [25, 10, 10], 25);
        isTrackInitialized = true;
    end
    label = ''; circle = zeros(0,3);
else
    if isObjectDetected
        predict(kalmanFilter);
        trackedLocation = correct(kalmanFilter, detectedLocation(1,:));
        label = 'Corrected';
    else
        trackedLocation = predict(kalmanFilter);
        label = 'Predicted';
    end
    circle = [trackedLocation, 5];
end

colorImage = insertObjectAnnotation(colorImage,'circle',...
    circle,label,'Color','red');
step(videoPlayer,colorImage);
pause(0.1);
end
```

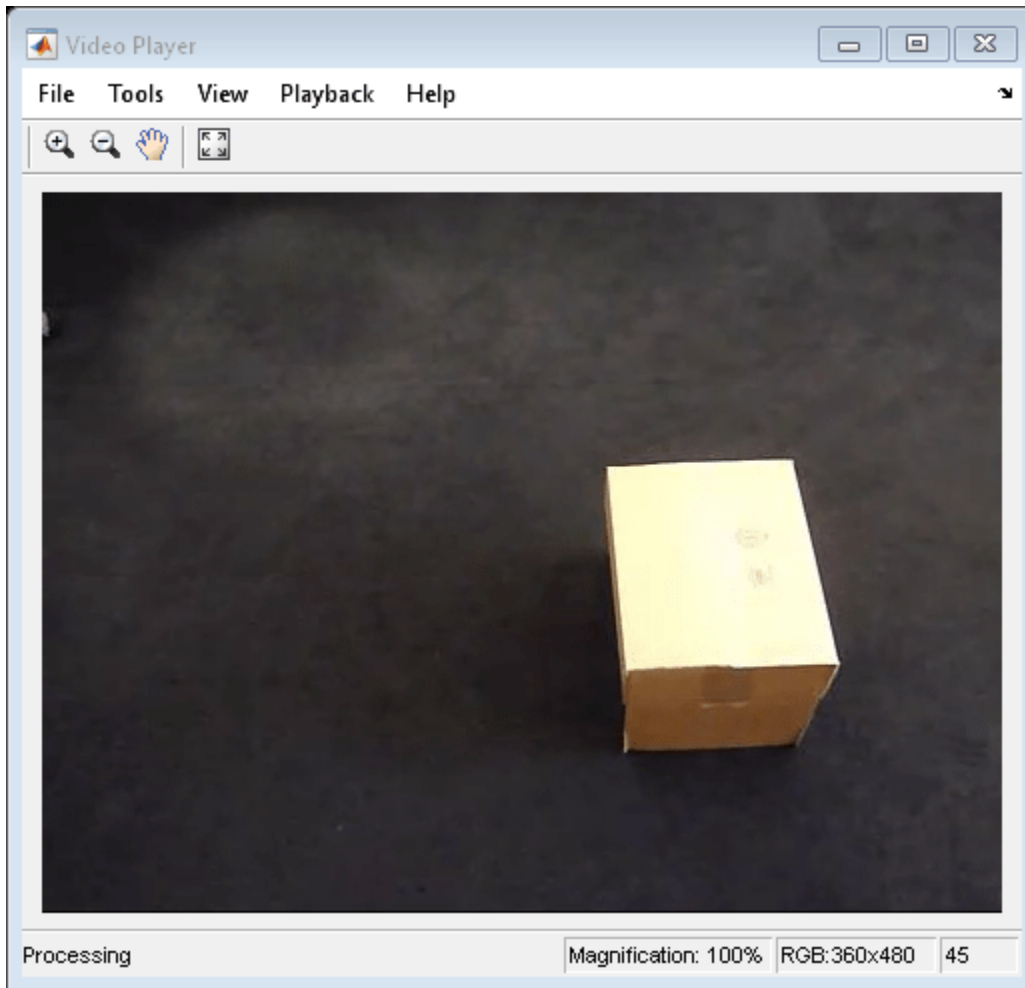

Release resources.

```
release(videoPlayer);
```

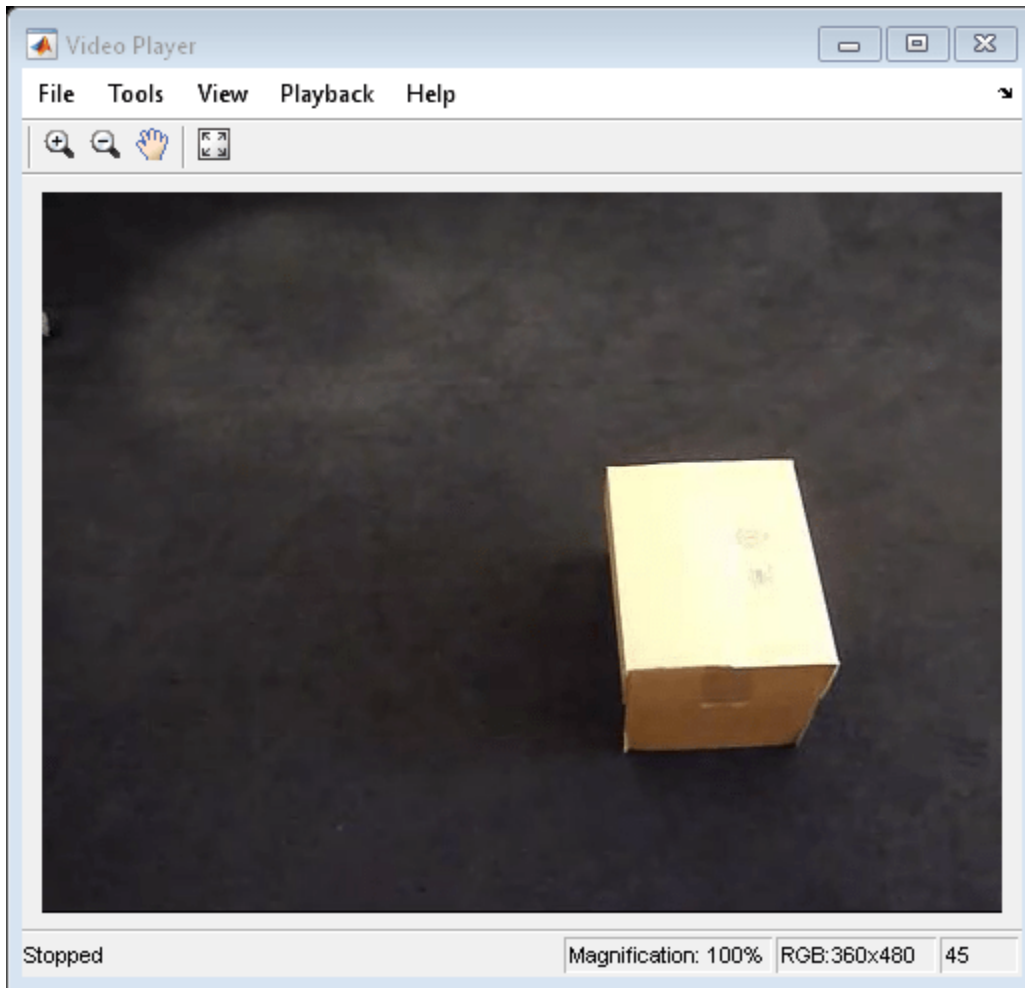

Input Arguments

MotionModel – Motion model

'ConstantVelocity' | 'ConstantAcceleration'

Motion model, specified as 'ConstantVelocity' or 'ConstantAcceleration'. The motion model you select applies to all dimensions. For example, for the 2-D Cartesian coordinate system. This mode applies to both X and Y directions.

Data Types: char

InitialLocation – Initial location of object

vector

Initial location of object, specified as a numeric vector. This argument also determines the number of dimensions for the coordinate system. For example, if you specify the initial location as a two-element vector, $[x_0, y_0]$, then a 2-D coordinate system is assumed.

Data Types: double | single | int8 | int16 | int32 | int64 | uint8 | uint16 | uint32 | uint64

InitialEstimateError – Initial estimate uncertainty variance

2-element vector | 3-element vector

Initial estimate uncertainty variance, specified as a two- or three-element vector. The initial estimate error specifies the variance of the initial estimates of location, velocity, and acceleration of the tracked object. The function assumes a zero initial velocity and acceleration for the object, at the location you set with the `InitialLocation` property. You can set the `InitialEstimateError` to an approximated value:

(assumed values - actual values)² + the variance of the values

The value of this property affects the Kalman filter for the first few detections. Later, the estimate error is determined by the noise and input data. A larger value for the initial estimate error helps the Kalman filter to adapt to the detection results faster. However, a larger value also prevents the Kalman filter from removing noise from the first few detections.

Specify the initial estimate error as a two-element vector for constant velocity or a three-element vector for constant acceleration:

MotionModel	InitialEstimateError
ConstantVelocity	[LocationVariance, VelocityVariance]
ConstantAcceleration	[LocationVariance, VelocityVariance, AccelerationVariance]

Data Types: double | single

MotionNoise — Deviation of selected and actual model

2-element vector | 3-element vector

Deviation of selected and actual model, specified as a two- or three-element vector. The motion noise specifies the tolerance of the Kalman filter for the deviation from the chosen model. This tolerance compensates for the difference between the object's actual motion and that of the model you choose. Increasing this value may cause the Kalman filter to change its state to fit the detections. Such an increase may prevent the Kalman filter from removing enough noise from the detections. The values of this property stay constant and therefore may affect the long-term performance of the Kalman filter.

MotionModel	InitialEstimateError
ConstantVelocity	[LocationVariance, VelocityVariance]
ConstantAcceleration	[LocationVariance, VelocityVariance, AccelerationVariance]

Data Types: double | single

MeasurementNoise — Variance inaccuracy of detected location

scalar

Variance inaccuracy of detected location, specified as a scalar. It is directly related to the technique used to detect the physical objects. Increasing the `MeasurementNoise` value enables the Kalman filter to remove more noise from the detections. However, it may also cause the Kalman filter to adhere too closely to the motion model you chose, putting less emphasis on the detections. The values of this property stay constant, and therefore may affect the long-term performance of the Kalman filter.

Data Types: double | single

Output Arguments

kalmanFilter — Configured Kalman filter tracking

object

Configured Kalman filter, returned as a `vision.KalmanFilter` object for tracking.

Algorithms

This function provides a simple approach for configuring the `vision.KalmanFilter` object for tracking. The Kalman filter implements a discrete time, linear State-Space System. The `configureKalmanFilter` function sets the `vision.KalmanFilter` object properties.

The <code>InitialLocation</code> property corresponds to the measurement vector used in the Kalman filter state-space model. This table relates the measurement vector, M , to the state-space model for the Kalman filter.		
State transition model, A, and Measurement model, H		
The state transition model, A , and the measurement model, H of the state-space model, are set to block diagonal matrices made from M identical submatrices A_s and H_s , respectively:		
$A = \text{blkdiag}(A_s_1, A_s_2, \dots, A_s_M)$		
$H = \text{blkdiag}(H_s_1, H_s_2, \dots, H_s_M)$		
The submatrices A_s and H_s are described below:		
MotionModel	A_s	H_s
'ConstantVelocity'	[1 1; 0 1]	[1 0]
'ConstantAcceleration'	[1 1 0.5; 0 1 1; 0 0 1]	[1 0 0]
The Initial State, x:		
MotionModel	Initial state, x	
'ConstantVelocity'	[InitialLocation(1), 0, ..., InitialLocation(M), 0]	
'ConstantAcceleration'	[InitialLocation(1), 0, 0, ..., InitialLocation(M), 0, 0]	
The initial state estimation error covariance matrix, P:		
$P = \text{diag}(\text{repmat}(\text{InitialError}, [1, M]))$		
The process noise covariance, Q:		
$Q = \text{diag}(\text{repmat}(\text{MotionNoise}, [1, M]))$		
The measurement noise covariance, R:		
$R = \text{diag}(\text{repmat}(\text{MeasurementNoise}, [1, M])).$		

See Also

`vision.BlobAnalysis` | `vision.ForegroundDetector` | `vision.KalmanFilter`

Topics

“Use Kalman Filter for Object Tracking”

“Multiple Object Tracking”

Introduced in R2012b

detectBRISKFeatures

Detect BRISK features and return BRISKPoints object

Syntax

```
points = detectBRISKFeatures(I)
points = detectBRISKFeatures(I,Name,Value)
```

Description

`points = detectBRISKFeatures(I)` returns a `BRISKPoints` object, `points`. The object contains information about BRISK features detected in a 2-D grayscale input image, `I`. The `detectBRISKFeatures` function uses a Binary Robust Invariant Scalable Keypoints (BRISK) algorithm to detect multiscale corner features.

`points = detectBRISKFeatures(I,Name,Value)` uses additional options specified by one or more `Name,Value` pair arguments.

Examples

Detect BRISK Points in an Image and Mark Their Locations

Read the image.

```
I = imread('cameraman.tif');
```

Find the BRISK points.

```
points = detectBRISKFeatures(I);
```

Display the results.

```
imshow(I); hold on;
plot(points.selectStrongest(20));
```



Input Arguments

I — Input image

M-by-*N* 2-D grayscale image

Input image, specified in 2-D grayscale. The input image must be real and nonsparse.

Example:

Data Types: `single` | `double` | `int16` | `uint8` | `uint16` | `logical`

Name-Value Pair Arguments

Specify optional comma-separated pairs of `Name`, `Value` arguments. `Name` is the argument name and `Value` is the corresponding value. `Name` must appear inside quotes. You can specify several name and value pair arguments in any order as `Name1`, `Value1`, ..., `NameN`, `ValueN`.

Example: `'MinQuality',0.1,'ROI',[50,150,100,200]` specifies that the detector must use a 10% minimum accepted quality of corners within the designated region of interest. This region of interest is located at $x=50$, $y=150$. The ROI has a width of 100 pixels and a height of 200 pixels.

MinContrast — Minimum intensity difference

0.2 (default) | scalar

Minimum intensity difference between a corner and its surrounding region, specified as the comma-separated pair consisting of `'MinContrast'` and a scalar in the range (0 1). The minimum contrast value represents a fraction of the maximum value of the image class. Increase this value to reduce the number of detected corners.

MinQuality — Minimum accepted quality of corners

0.1 (default) | scalar

Minimum accepted quality of corners, specified as the comma-separated pair consisting of 'MinQuality' and a scalar value in the range [0,1]. The minimum accepted quality of corners represents a fraction of the maximum corner metric value in the image. Increase this value to remove erroneous corners.

NumOctaves — Number of octaves

4 (default) | scalar

Number of octaves to implement, specified as a comma-separated pair consisting of 'NumOctaves' and an integer scalar, greater than or equal to 0. Increase this value to detect larger blobs. Recommended values are between 1 and 4. When you set NumOctaves to 0, the function disables multiscale detection. It performs the detection at the scale of the input image, I.

ROI — Rectangular region

[1 1 size(I,2) size(I,1)] (default) | vector

Rectangular region for corner detection, specified as a comma-separated pair consisting of 'ROI' and a vector of the format [x y width height]. The first two integer values [x y] represent the location of the upper-left corner of the region of interest. The last two integer values represent the width and height.

Output Arguments

points — Brisk points

BRISKPoints object

Brisk points, returned as a BRISKPoints object. The object contains information about the feature points detected in the 2-D grayscale input image.

References

[1] Leutenegger, S., M. Chli and R. Siegwart. "BRISK: Binary Robust Invariant Scalable Keypoints", *Proceedings of the IEEE International Conference, ICCV, 2011*.

Extended Capabilities

C/C++ Code Generation

Generate C and C++ code using MATLAB® Coder™.

Usage notes and limitations:

- Generates portable C code using a C++ compiler that links to OpenCV (Version 3.4.0) libraries. See "Portable C Code Generation for Functions That Use OpenCV Library".

See Also

Functions

detectSURFFeatures | detectMinEigenFeatures | detectFASTFeatures | detectHarrisFeatures | detectMSERFeatures | detectKAZEFeatures | detectORBFeatures | extractFeatures | extractHOGFeatures | detectFASTFeatures | matchFeatures

Objects

MSERRegions | SURFPoints | BRISKPoints | cornerPoints | binaryFeatures

Topics

“Point Feature Types”

Introduced in R2014a

detectCheckerboardPoints

Detect checkerboard pattern in image

Syntax

```
[imagePoints,boardSize] = detectCheckerboardPoints(I)
```

```
[imagePoints,boardSize,imagesUsed] = detectCheckerboardPoints(imageFileNames)
[imagePoints,boardSize,imagesUsed] = detectCheckerboardPoints(images)
```

```
[imagePoints,boardSize,pairsUsed] = detectCheckerboardPoints(imageFileNames1,
imageFileNames2)
```

```
[imagePoints,boardSize,pairsUsed] = detectCheckerboardPoints(images1,images2)
```

```
[imagePoints,boardSize,pairsUsed] = detectCheckerboardPoints( ____,Name,Value)
```

Description

`[imagePoints,boardSize] = detectCheckerboardPoints(I)` detects a black and white checkerboard of size greater than 4-by-4 squares in a 2-D truecolor or grayscale image. The function returns the detected points and dimensions of the checkerboard.

`[imagePoints,boardSize,imagesUsed] = detectCheckerboardPoints(imageFileNames)` detects a checkerboard pattern in a set of input images, provided as an array of file names.

`[imagePoints,boardSize,imagesUsed] = detectCheckerboardPoints(images)` detects a checkerboard pattern in a set of input images, provided as an array of grayscale or truecolor images.

`[imagePoints,boardSize,pairsUsed] = detectCheckerboardPoints(imageFileNames1, imageFileNames2)` detects a checkerboard pattern in stereo pairs of images, provided as cell arrays of file names.

`[imagePoints,boardSize,pairsUsed] = detectCheckerboardPoints(images1,images2)` detects a checkerboard pattern in stereo pairs of images, provided as arrays of grayscale or truecolor images.

`[imagePoints,boardSize,pairsUsed] = detectCheckerboardPoints(____,Name,Value)` uses additional options specified by one or more Name,Value pair arguments. Unspecified properties have default values.

Examples

Detect Checkerboard in Images with High Distortion

Create an `imageDatastore` containing calibration images from a GoPro camera.

```
imds = imageDatastore(fullfile(toolboxdir('vision'),'visiondata','calibration','gopro'));
```

Detect calibration pattern using the 'HighDistortion' option, which is good to use with fisheye lens images.

```
[imagePoints,boardSize,imagesUsed] = detectCheckerboardPoints(imds.Files(1:4),'HighDistortion',t
```

Display detected points.

```
for i = 1:4
    % Read image
    I = readimage(imds, i);

    % Insert markers at detected point locations
    I = insertMarker(I, imagePoints(:,:,i), 'o', 'Color', 'red', 'Size', 10);

    % Display image
    subplot(2, 2, i);
    imshow(I);
end
```



Detect Checkerboard in Image

Load an image containing a checkerboard pattern.

```
imageFileName = fullfile(toolboxdir('vision'),'visiondata','calibration','webcam','image4.tif');
I = imread(imageFileName);
```

Detect the checkerboard points.

```
[imagePoints,boardSize] = detectCheckerboardPoints(I);
```

Display detected points.

```
J = insertText(I,imagePoints,1:size(imagePoints,1));
J = insertMarker(J,imagePoints,'o','Color','red','Size',5);
imshow(J);
title(sprintf('Detected a %d x %d Checkerboard',boardSize));
```

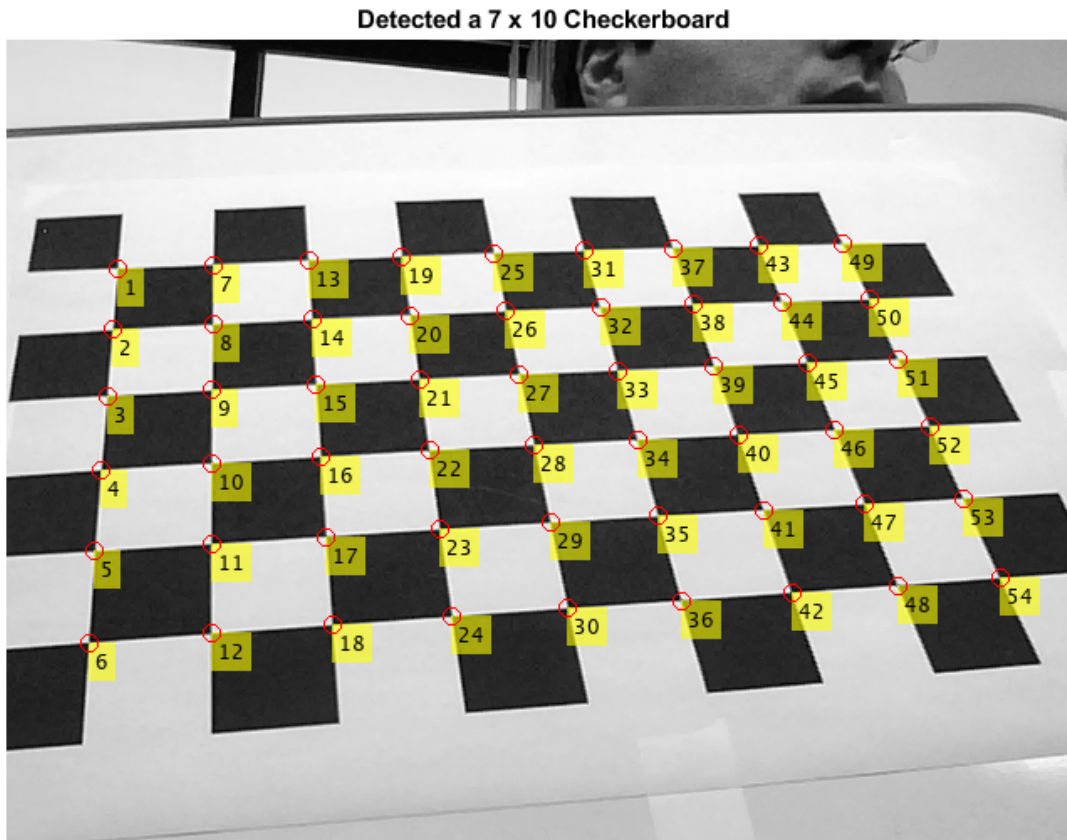

Detect Checkerboard in a Set of Image Files

Create a cell array of file names of calibration images.

```
for i = 1:5
    imageFileName = sprintf('image%d.tif', i);
    imageFileNames{i} = fullfile(matlabroot,'toolbox','vision',...
        'visiondata','calibration','webcam',imageFileName);
end
```

Detect calibration pattern in the images.

```
[imagePoints,boardSize,imagesUsed] = detectCheckerboardPoints(imageFileNames, 'PartialDetections
```

Display the detected points.

```
imageFileNames = imageFileNames(imagesUsed);
for i = 1:numel(imageFileNames)
    I = imread(imageFileNames{i});
    subplot(2, 2, i);
    imshow(I);
    hold on;
    plot(imagePoints(:,1,i),imagePoints(:,2,i),'ro');
end
```

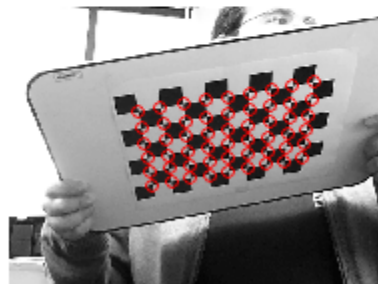
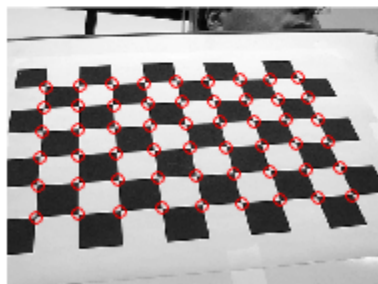
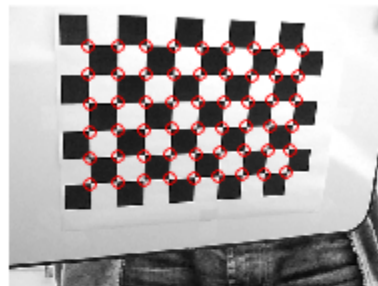
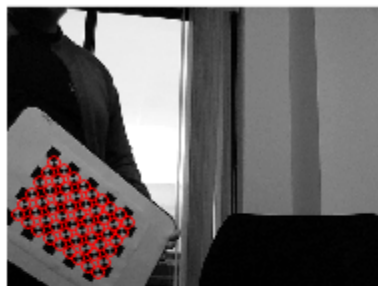

Detect Checkerboard in Stereo Images

Read in stereo images.

```
numImages = 4;
images1 = cell(1, numImages);
images2 = cell(1, numImages);
for i = 1:numImages
    images1{i} = fullfile(matlabroot,'toolbox','vision',...
        'visiondata','calibration','stereo','left',sprintf('left%02d.png',i));
    images2{i} = fullfile(matlabroot,'toolbox','vision',...
        'visiondata','calibration','stereo','right',sprintf('right%02d.png',i));
end
```

Detect the checkerboards in the images.

```
[imagePoints,boardSize,pairsUsed] = ...
    detectCheckerboardPoints(images1,images2);
```

Display points from images1.

```
images1 = images1(pairsUsed);
figure;
for i = 1:numel(images1)
    I = imread(images1{i});
    subplot(2,2,i);
    imshow(I);
    hold on;
    plot(imagePoints(:,1,i,1),imagePoints(:,2,i,1),'ro');
end
annotation('textbox',[0 0.9 1 0.1],'String','Camera 1',...
    'EdgeColor','none','HorizontalAlignment','center')
```

Camera 1

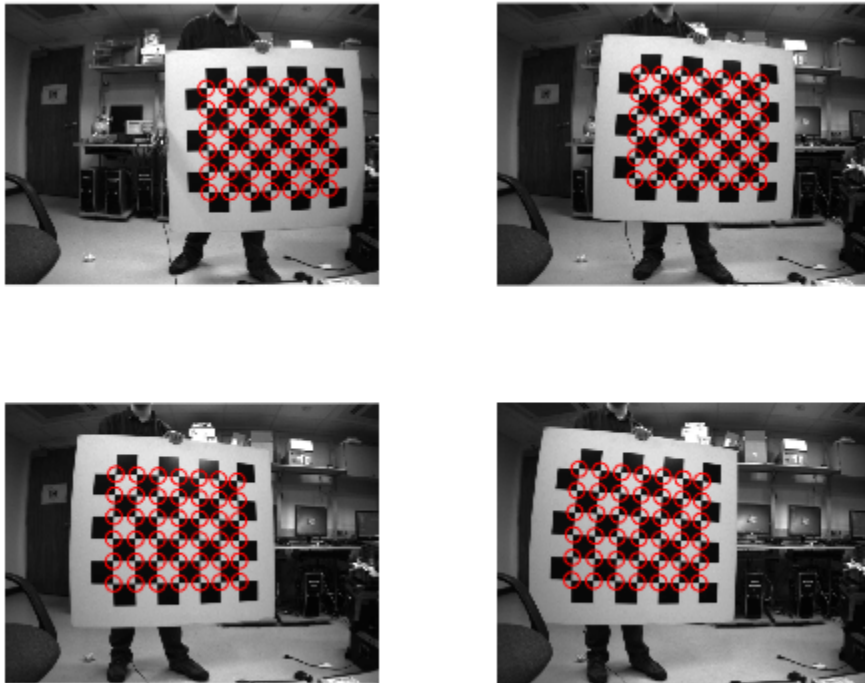

Display points from images2.

```
images2 = images2(pairsUsed);
figure;
for i = 1:numel(images2)
    I = imread(images2{i});
    subplot(2, 2, i);
    imshow(I);
    hold on;
    plot(imagePoints(:,1,i,2),imagePoints(:,2,i,2),'ro');
end
```

```
annotation('textbox',[0 0.9 1 0.1],'String','Camera 2',...
    'EdgeColor','none','HorizontalAlignment','center')
```

Camera 2

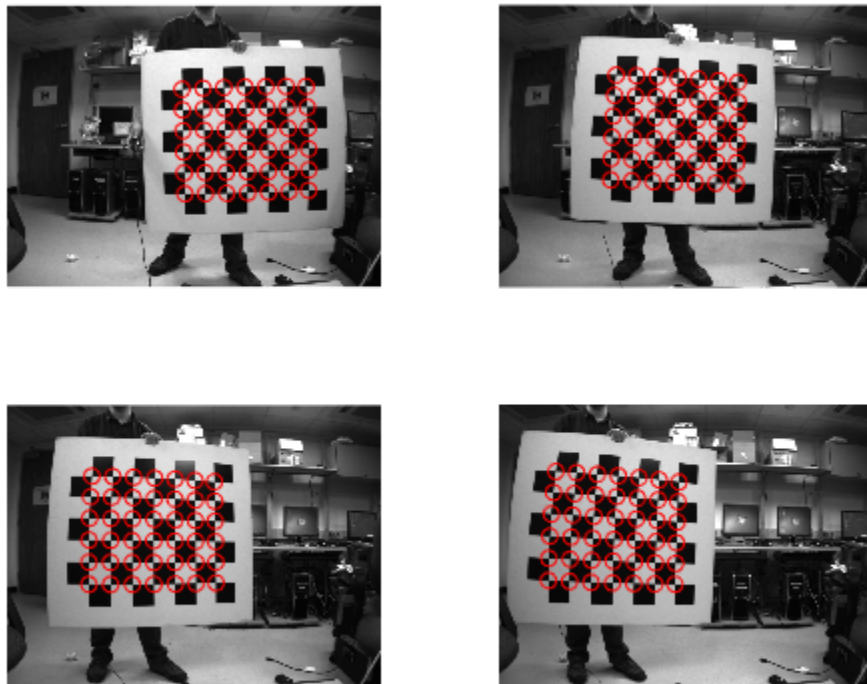

Input Arguments

I — Input image

M-by-*N*-by-3 truecolor image | *M*-by-*N* 2-D grayscale image

Input image, specified as either an *M*-by-*N*-by-3 truecolor or *M*-by-*N* 2-D grayscale. The input image must be real and nonsparse. The function can detect checkerboards with a minimum size of 4-by-4 squares.

Data Types: single | double | int16 | uint8 | uint16 | logical

imageFileNames — Image file names

N-element cell array

Image file names, specified as an *N*-element cell array of *N* file names.

imageFileNames1 — File names for camera 1 images

N-element cell array

File names for camera 1 images, specified as an *N*-element cell array of *N* file names. The images contained in this array must be in the same order as images contained in `imageFileNames2`, forming stereo pairs.

imageFileNames2 — File names for camera 2 images*N*-element cell array

File names for camera 2 images, specified as an *N*-element cell array of *N* file names. The images contained in this array must be in the same order as images contained in `imageFileNames1`, forming stereo pairs.

images — Images*height-by-width-by-color channel-by-number of frames* array

Images, specified as an *H*-by-*W*-by-*B*-by-*F* array containing a set of grayscale or truecolor images. The input dimensions are:

H represents the image height.

W represents the image width.

B represents the color channel. A value of 1 indicates a grayscale image, and a value of 3 indicates a truecolor image.

F represents the number of image frames.

images1 — Stereo pair images from camera 1*height-by-width-by-color channel-by-number of frames* array

Stereo pair images from camera 1, specified as an *H*-by-*W*-by-*B*-by-*F* array containing a set of grayscale or truecolor images. The input dimensions are:

H represents the image height.

W represents the image width.

B represents the color channel. A value of 1 indicates a grayscale image, and a value of 3 indicates a truecolor image.

F represents the number of image frames.

images2 — Stereo pair images from camera 2*height-by-width-by-color channel-by-number of frames* array

Stereo pair images from camera 2, specified as an *H*-by-*W*-by-*B*-by-*F* array containing a set of grayscale or truecolor images. The input dimensions are:

H represents the image height.

W represents the image width.

B represents the color channel. A value of 1 indicates a grayscale image, and a value of 3 indicates a truecolor image.

F represents the number of image frames.

Name-Value Pair Arguments

Specify optional comma-separated pairs of `Name`, `Value` arguments. `Name` is the argument name and `Value` is the corresponding value. `Name` must appear inside quotes. You can specify several name and value pair arguments in any order as `Name1, Value1, ..., NameN, ValueN`.

Example: `'MinCornerMetric', '0.15'`

MinCornerMetric — Minimum corner metric threshold`0.15` | `0.12` | nonnegative scalar

Minimum corner metric threshold, specified as a nonnegative scalar. When the image is noisy or highly textured, increase this value to reduce the number of false corner detections. When you set the `'HighDistortion'` property to `false` the function sets the default value to `0.15`. When you set the

'HighDistortion' property to `true` the function sets the default value to `0.12`. Decreasing the value results in an increase of corner detections.

HighDistortion — High distortion

`false` (default) | `true`

High distortion, specified as `false` or `true`. Set 'HighDistortion' to `true` when the images contain a high level of distortion, which is typical of a wide field of view camera, such as a fisheye camera. Set 'HighDistortion' to `false` when the images do not contain a high level of distortion. Setting 'HighDistortion' to `true` can increase the resiliency to image distortion but decreases the processing speed.

PartialDetections — Partial detections

`true` (default) | `false`

Partial detections, specified as `true` or `false`. Set 'PartialDetections' to `true` to return partially detected checkerboards. The function fills missing keypoint detections with `[NaN, NaN]` coordinates. Set 'PartialDetections' to `false` to discard partially detected checkerboards. This property is ignored for stereo image pairs.

Output Arguments

imagePoints — Detected checkerboard corner coordinates

M-by-2 matrix | *M*-by-2-by- *number of images* array | *M*-by-2-by-*number of pairs of images*-by-*number of cameras* array

Detected checkerboard corner coordinates, returned as an *M*-by-2 matrix for one image. For multiple images, points are returned as an *M*-by-2-by-*number of images* array, and for stereo pairs of images, the function returns points as an *M*-by-2-by-*number of pairs*-by-*number of cameras* array.

For stereo pairs, `imagePoints(:,:,1)` are the points from the first set of images, and `imagePoints(:,:,2)` are the points from the second set of images. The output contains *M* number of `[x y]` coordinates. Each coordinate represents a point where square corners are detected on the checkerboard. The number of points the function returns depends on the value of `boardSize`, which indicates the number of squares detected. The function detects the points with sub-pixel accuracy.

The function calculates the number of points, *M*, as follows:

`M = prod(boardSize-1)`.

If the checkerboard cannot be detected:

`imagePoints = []`

`boardSize = [0,0]`

When you specify the `imageFileNames` input, the function can return `imagePoints` as an *M*-by-2-by-*N* array. In this array, *N* represents the number of images in which a checkerboard is detected. If a checkerboard cannot be detected, the function sets `imagePoints` to `[]`.

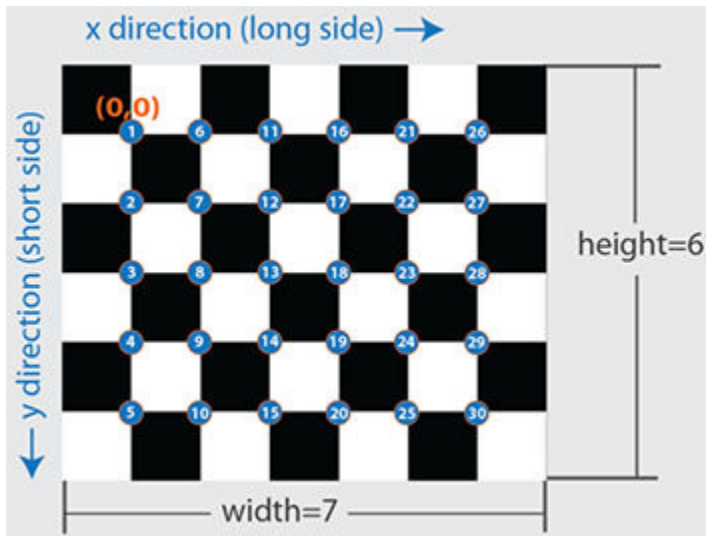

For single camera images only:

- If the complete checkerboard cannot be detected, the function returns a partially detected checkerboard with `[NaN, NaN]` as the x-y coordinates for missing corners in `imagePoints`. This default behavior can be modified using the 'PartialDetections' name-value argument.
- When possible, the function orients the partially detected checkerboard such that the location of the origin and the arrangement of the corners is consistent with the completely visible checkerboard. If the function cannot detect a complete checkerboard in any of the input images, the largest detected checkerboard is used as the reference checkerboard.

boardSize — Checkerboard dimensions

2-element `[height, width]` vector

Checkerboard dimensions, returned as a 2-element `[height, width]` vector. The dimensions of the checkerboard are expressed in terms of the number of squares.

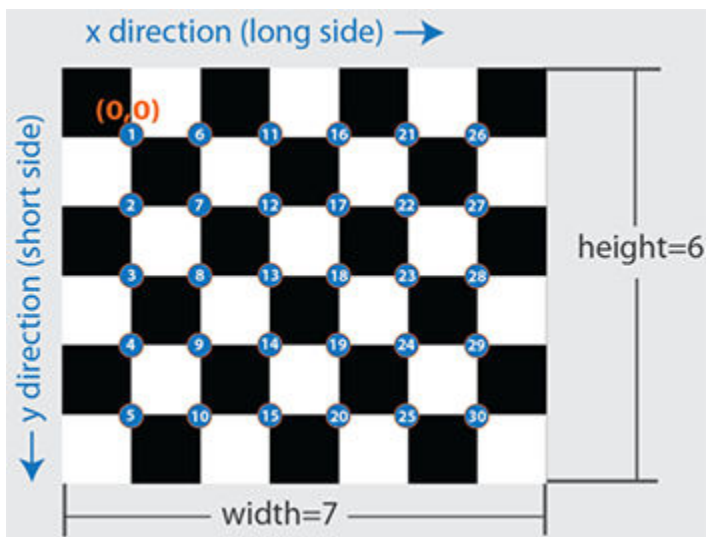

If a checkerboard cannot be detected, the function sets `boardSize` to `[0, 0]`.

imagesUsed — Pattern detection flag

N-by-1 logical vector

Pattern detection flag, returned as an *N*-by-1 logical vector of *N* logicals. The function outputs the same number of logicals as there are input images. A `true` value indicates that the pattern was detected in the corresponding image. A `false` value indicates that the function did not detect a pattern.

pairsUsed — Stereo pair pattern detection flag

N-by-1 logical vector

Stereo pair pattern detection flag, returned as an *N*-by-1 logical vector of *N* logicals. The function outputs the same number of logicals as there are input images. A `true` value indicates that the pattern is detected in the corresponding stereo image pair. A `false` value indicates that the function does not detect a pattern.

For stereo pair pattern detection, the checkerboard needs to be fully visible in both images for it to be detected. Unlike single camera calibration, partially detected checkerboards are rejected for stereo image pairs.

References

- [1] Geiger, A., F. Moosmann, O. Car, and B. Schuster. "Automatic Camera and Range Sensor Calibration using a Single Shot," *International Conference on Robotics and Automation (ICRA)*, St. Paul, USA, May 2012.

Extended Capabilities**C/C++ Code Generation**

Generate C and C++ code using MATLAB® Coder™.

Usage notes and limitations:

- Code generation will not support specifying images as file names or cell arrays of file names. It supports only checkerboard detection in a single image or stereo pair of images. For example, these syntaxes are supported:

- `detectCheckerboardPoints(I1)`
- `detectCheckerboardPoints(I1,I2)`

I1 and *I2* are single grayscale or RGB images.

See Also

`estimateCameraParameters` | `generateCheckerboardPoints` | `cameraParameters` | `stereoParameters` | **Camera Calibrator**

Topics

"Using the Single Camera Calibrator App"

Introduced in R2014a

detectFASTFeatures

Detect corners using FAST algorithm and return `cornerPoints` object

Syntax

```
points = detectFASTFeatures(I)  
points = detectFASTFeatures(I,Name,Value)
```

Description

`points = detectFASTFeatures(I)` returns a `cornerPoints` object, `points`. The object contains information about the feature points detected in a 2-D grayscale input image, `I`. The `detectFASTFeatures` function uses the Features from Accelerated Segment Test (FAST) algorithm to find feature points.

`points = detectFASTFeatures(I,Name,Value)` uses additional options specified by one or more `Name,Value` pair arguments.

Examples

Find Corner Points in an Image Using the FAST Algorithm

Read the image.

```
I = imread('cameraman.tif');
```

Find the corners.

```
corners = detectFASTFeatures(I);
```

Display the results.

```
imshow(I); hold on;  
plot(corners.selectStrongest(50));
```



Input Arguments

I — Input image

M-by-*N* 2-D grayscale image

Input image, specified in 2-D grayscale. The input image must be real and nonsparse.

Data Types: `single` | `double` | `int16` | `uint8` | `uint16` | `logical`

Name-Value Pair Arguments

Specify optional comma-separated pairs of `Name`, `Value` arguments. `Name` is the argument name and `Value` is the corresponding value. `Name` must appear inside quotes. You can specify several name and value pair arguments in any order as `Name1`, `Value1`, ..., `NameN`, `ValueN`.

Example: `'MinQuality','0.01','ROI',[50,150,100,200]` specifies that the detector must use a 1% minimum accepted quality of corners within the designated region of interest. This region of interest is located at $x=50$, $y=150$. The ROI has a width of 100 pixels, and a height of 200 pixels.

MinQuality — Minimum accepted quality of corners

0.1 (default)

Minimum accepted quality of corners, specified as the comma-separated pair consisting of `'MinQuality'` and a scalar value in the range $[0,1]$.

The minimum accepted quality of corners represents a fraction of the maximum corner metric value in the image. Larger values can be used to remove erroneous corners.

Data Types: `single` | `double` | `int8` | `int16` | `int32` | `int64` | `uint8` | `uint16` | `uint32` | `uint64`

MinContrast — Minimum intensity

0.2 (default)

Minimum intensity difference between corner and surrounding region, specified as the comma-separated pair consisting of 'MinContrast' and a scalar value in the range (0,1).

The minimum intensity represents a fraction of the maximum value of the image class. Increasing the value reduces the number of detected corners.

Data Types: `single` | `double` | `int8` | `int16` | `int32` | `int64` | `uint8` | `uint16` | `uint32` | `uint64`

ROI — Rectangular region

`[1 1 size(I,2) size(I,1)]` (default) | vector

Rectangular region for corner detection, specified as a comma-separated pair consisting of 'ROI' and a vector of the format `[x y width height]`. The first two integer values `[x y]` represent the location of the upper-left corner of the region of interest. The last two integer values represent the width and height.

Example: 'ROI', `[50, 150, 100, 200]`

Output Arguments

points — Corner points

`cornerPoints` object

Corner points object, returned as a `cornerPoints` object. The object contains information about the feature points detected in the 2-D grayscale input image.

References

- [1] Rosten, E., and T. Drummond. "Fusing Points and Lines for High Performance Tracking," *Proceedings of the IEEE International Conference on Computer Vision*, Vol. 2 (October 2005): pp. 1508-1511.

Extended Capabilities

C/C++ Code Generation

Generate C and C++ code using MATLAB® Coder™.

Usage notes and limitations:

- Generates portable C code using a C++ compiler that links to OpenCV (Version 3.4.0) libraries. See "Portable C Code Generation for Functions That Use OpenCV Library".

GPU Arrays

Accelerate code by running on a graphics processing unit (GPU) using Parallel Computing Toolbox™.

- GPU support will be removed in a future release.
- This function fully supports GPU arrays. For more information, see "Run MATLAB Functions on a GPU" (Parallel Computing Toolbox).

See Also

Functions

detectSURFFeatures | detectMinEigenFeatures | detectBRISKFeatures |
detectHarrisFeatures | detectMSERFeatures | detectKAZEFeatures | detectORBFeatures
| extractFeatures | extractHOGFeatures | detectFASTFeatures | matchFeatures

Objects

MSERRegions | SURFPoints | BRISKPoints | cornerPoints | binaryFeatures

Topics

“Find Corner Points Using the Eigenvalue Algorithm” on page 3-409

“Find Corner Points Using the Harris-Stephens Algorithm” on page 3-405

“Point Feature Types”

Introduced in R2013a

detectHarrisFeatures

Detect corners using Harris-Stephens algorithm and return `cornerPoints` object

Syntax

```
points = detectHarrisFeatures(I)
points = detectHarrisFeatures(I,Name,Value)
```

Description

`points = detectHarrisFeatures(I)` returns a `cornerPoints` object, `points`. The object contains information about the feature points detected in a 2-D input image, `I`. The `detectHarrisFeatures` function uses the Harris-Stephens algorithm to find these feature points.

`points = detectHarrisFeatures(I,Name,Value)` uses additional options specified by one or more `Name,Value` pair arguments.

Examples

Find Corner Points Using the Harris-Stephens Algorithm

Read the image.

```
I = checkerboard;
```

Find the corners.

```
corners = detectHarrisFeatures(I);
```

Display the results.

```
imshow(I); hold on;
plot(corners.selectStrongest(50));
```

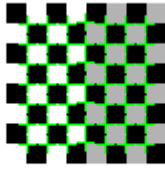

Input Arguments

I — Input image

M-by-*N* 2-D image

Input image, specified is an *M*-by-*N* 2-D image. The input image must be real and nonsparse.

Data Types: `single` | `double` | `int16` | `uint8` | `uint16` | `logical`

Name-Value Pair Arguments

Specify optional comma-separated pairs of `Name`, `Value` arguments. `Name` is the argument name and `Value` is the corresponding value. `Name` must appear inside quotes. You can specify several name and value pair arguments in any order as `Name1`, `Value1`, ..., `NameN`, `ValueN`.

Example: `'MinQuality','0.01','ROI',[50,150,100,200]` specifies that the detector must use a 1% minimum accepted quality of corners within the designated region of interest. This region of interest is located at $x=50$, $y=150$. The ROI has a width of 100 pixels and a height of 200 pixels.

MinQuality — Minimum accepted quality of corners

0.01 (default)

Minimum accepted quality of corners, specified as the comma-separated pair consisting of `'MinQuality'` and a scalar value in the range [0,1].

The minimum accepted quality of corners represents a fraction of the maximum corner metric value in the image. Larger values can be used to remove erroneous corners.

Example: `'MinQuality',0.01`

Data Types: `single` | `double` | `int8` | `int16` | `int32` | `int64` | `uint8` | `uint16` | `uint32` | `uint64`

FilterSize — Gaussian filter dimension

5 (default)

Gaussian filter dimension, specified as the comma-separated pair consisting of `'FilterSize'` and an odd integer value in the range [3, `min(size(I))`].

The Gaussian filter smooths the gradient of the input image.

The function uses the `FilterSize` value to calculate the filter's dimensions, `FilterSize`-by-`FilterSize`. It also defines the standard deviation of the Gaussian filter as `FilterSize/3`.

Example: `'FilterSize',5`

Data Types: `single` | `double` | `int8` | `int16` | `int32` | `int64` | `uint8` | `uint16` | `uint32` | `uint64`

ROI — Rectangular region

`[1 1 size(I,2) size(I,1)]` (default) | vector

Rectangular region for corner detection, specified as a comma-separated pair consisting of 'ROI' and a vector of the format `[x y width height]`. The first two integer values `[x y]` represent the location of the upper-left corner of the region of interest. The last two integer values represent the width and height.

Example: 'ROI', `[50,150,100,200]`

Output Arguments

points — Corner points

`cornerPoints` object

Corner points object, returned as a `cornerPoints` object. The object contains information about the feature points detected in the 2-D input image.

References

[1] Harris, C., and M. Stephens, "A Combined Corner and Edge Detector," *Proceedings of the 4th Alvey Vision Conference*, August 1988, pp. 147-151.

Extended Capabilities

C/C++ Code Generation

Generate C and C++ code using MATLAB® Coder™.

Usage notes and limitations:

- Use in a MATLAB Function block is not supported.
- 'FilterSize' must be a compile-time constant.
- Generated code for this function uses a precompiled platform-specific shared library.

GPU Arrays

Accelerate code by running on a graphics processing unit (GPU) using Parallel Computing Toolbox™.

This function fully supports GPU arrays. For more information, see "Run MATLAB Functions on a GPU" (Parallel Computing Toolbox).

See Also

Functions

`detectSURFFeatures` | `detectMinEigenFeatures` | `detectBRISKFeatures` | `detectFASTFeatures` | `detectMSERFeatures` | `detectKAZEFeatures` | `detectORBFeatures` | `extractFeatures` | `extractHOGFeatures` | `detectFASTFeatures` | `matchFeatures`

Objects

`MSERRegions` | `SURFPoints` | `BRISKPoints` | `cornerPoints` | `binaryFeatures`

Topics

“Find Corner Points Using the Eigenvalue Algorithm” on page 3-409

“Find Corner Points in an Image Using the FAST Algorithm” on page 3-401

“Point Feature Types”

Introduced in R2013a

detectMinEigenFeatures

Detect corners using minimum eigenvalue algorithm and return `cornerPoints` object

Syntax

```
points = detectMinEigenFeatures(I)
points = detectMinEigenFeatures(I,Name,Value)
```

Description

`points = detectMinEigenFeatures(I)` returns a `cornerPoints` object, `points`. The object contains information about the feature points detected in a 2-D grayscale input image, `I`. The `detectMinEigenFeatures` function uses the minimum eigenvalue algorithm developed by Shi and Tomasi to find feature points.

`points = detectMinEigenFeatures(I,Name,Value)` uses additional options specified by one or more `Name,Value` pair arguments.

Examples

Find Corner Points Using the Eigenvalue Algorithm

Read the image.

```
I = checkerboard;
```

Find the corners.

```
corners = detectMinEigenFeatures(I);
```

Display the results.

```
imshow(I); hold on;
plot(corners.selectStrongest(50));
```

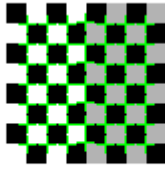

Input Arguments

I — Input image

M-by-*N* 2-D grayscale image

Input image, specified in 2-D grayscale. The input image must be real and nonsparse.

Data Types: `single` | `double` | `int16` | `uint8` | `uint16` | `logical`

Name-Value Pair Arguments

Specify optional comma-separated pairs of `Name`, `Value` arguments. `Name` is the argument name and `Value` is the corresponding value. `Name` must appear inside quotes. You can specify several name and value pair arguments in any order as `Name1`, `Value1`, ..., `NameN`, `ValueN`.

Example: `'MinQuality', '0.01', 'ROI', [50, 150, 100, 200]` specifies that the detector must use a 1% minimum accepted quality of corners within the designated region of interest. This region of interest is located at $x=50$, $y=150$. The ROI has a width of 100 pixels, and a height of 200 pixels.

MinQuality — Minimum accepted quality of corners

0.01 (default)

Minimum accepted quality of corners, specified as the comma-separated pair consisting of `'MinQuality'` and a scalar value in the range [0,1].

The minimum accepted quality of corners represents a fraction of the maximum corner metric value in the image. Larger values can be used to remove erroneous corners.

Example: `'MinQuality', 0.01`

Data Types: `single` | `double` | `int8` | `int16` | `int32` | `int64` | `uint8` | `uint16` | `uint32` | `uint64`

FilterSize — Gaussian filter dimension

5 (default)

Gaussian filter dimension, specified as the comma-separated pair consisting of `'FilterSize'` and an odd integer value in the range [3, inf).

The Gaussian filter smooths the gradient of the input image.

The function uses the `FilterSize` value to calculate the filter's dimensions, `FilterSize`-by-`FilterSize`. It also defines the standard deviation as `FilterSize/3`.

Example: `'FilterSize', 5`

Data Types: `single` | `double` | `int8` | `int16` | `int32` | `int64` | `uint8` | `uint16` | `uint32` | `uint64`

ROI — Rectangular region

[1 1 `size(I,2)` `size(I,1)`] (default) | vector

Rectangular region for corner detection, specified as a comma-separated pair consisting of 'ROI' and a vector of the format [`x y width height`]. The first two integer values [`x y`] represent the location of the upper-left corner of the region of interest. The last two integer values represent the width and height.

Example: 'ROI', [50,150,100,200]

Output Arguments

points — Corner points

`cornerPoints` object

Corner points, returned as a `cornerPoints` object. The object contains information about the feature points detected in the 2-D grayscale input image.

References

[1] Shi, J., and C. Tomasi, "Good Features to Track," *Proceedings of the IEEE Conference on Computer Vision and Pattern Recognition*, June 1994, pp. 593-600.

Extended Capabilities

C/C++ Code Generation

Generate C and C++ code using MATLAB® Coder™.

Usage notes and limitations:

- Use in a MATLAB Function block is not supported.
- 'FilterSize' must be a compile-time constant.
- Generated code for this function uses a precompiled platform-specific shared library.

See Also

Functions

`detectSURFFeatures` | `detectBRISKFeatures` | `detectFASTFeatures` | `detectHarrisFeatures` | `detectMSERFeatures` | `detectKAZEFeatures` | `detectORBFeatures` | `extractFeatures` | `extractHOGFeatures` | `detectFASTFeatures` | `matchFeatures`

Objects

`MSERRegions` | `SURFPoints` | `BRISKPoints` | `cornerPoints` | `binaryFeatures`

Topics

"Find Corner Points Using the Harris-Stephens Algorithm" on page 3-405
 "Find Corner Points in an Image Using the FAST Algorithm" on page 3-401
 "Point Feature Types"

Introduced in R2013a

detectMSERFeatures

Detect MSER features and return MSERRegions object

Syntax

```
regions = detectMSERFeatures(I)
[regions,cc] = detectMSERFeatures(I)
[ ___ ] = detectMSERFeatures(I,Name,Value)
```

Description

`regions = detectMSERFeatures(I)` returns an `MSERRegions` object, `regions`, containing information about MSER features detected in the 2-D grayscale input image, `I`. This object uses Maximally Stable Extremal Regions (MSER) algorithm to find regions.

Note For Simulink support using this function, you must enable the model configuration settings. To display the dialog box, in the Simulink Editor, select the **Modeling** tab and then select **Model Settings > Model Properties**. In the **Configuration Parameters** dialog box, select **Simulation Target > Advanced Parameters > Dynamic Memory allocation in MATLAB functions**.

`[regions,cc] = detectMSERFeatures(I)` optionally returns MSER regions in a connected component structure.

`[___] = detectMSERFeatures(I,Name,Value)` sets additional options specified by one or more `Name,Value` pair arguments.

Examples

Find MSER Regions in an Image

Read image and detect MSER regions.

```
I = imread('cameraman.tif');
regions = detectMSERFeatures(I);
```

Visualize MSER regions which are described by pixel lists stored inside the returned 'regions' object.

```
figure; imshow(I); hold on;
plot(regions,'showPixelList',true,'showEllipses',false);
```

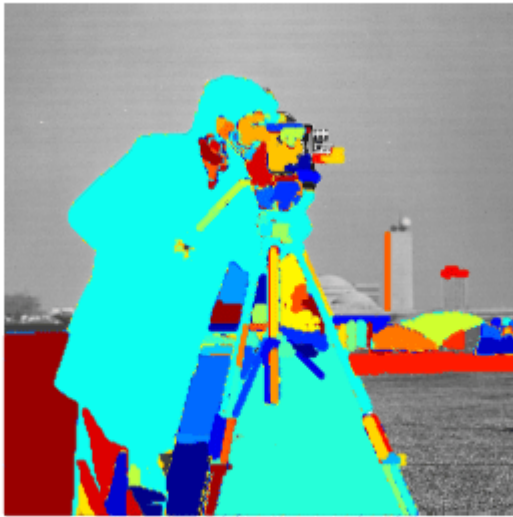

Display ellipses and centroids fit into the regions. By default, plot displays ellipses and centroids.

```
figure; imshow(I);  
hold on;  
plot(regions);
```



Find circular MSER regions

Detect MSER regions.

```
I = imread('coins.png');
[regions,mserCC] = detectMSERFeatures(I);
```

Show all detected MSER Regions.

```
figure
imshow(I)
hold on
plot(regions,'showPixelList',true,'showEllipses',false)
```

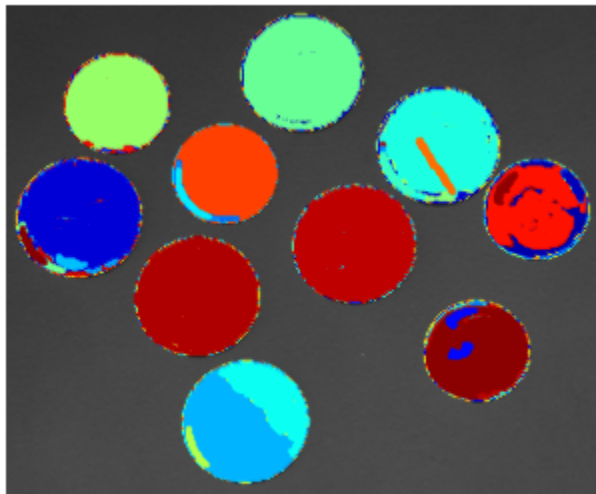

Measure the MSER region eccentricity to gauge region circularity.

```
stats = regionprops('table',mserCC,'Eccentricity');
```

Threshold eccentricity values to only keep the circular regions. (Circular regions have low eccentricity.)

```
eccentricityIdx = stats.Eccentricity < 0.55;
circularRegions = regions(eccentricityIdx);
```

Show the circular regions.

```
figure
imshow(I)
hold on
plot(circularRegions,'showPixelList',true,'showEllipses',false)
```

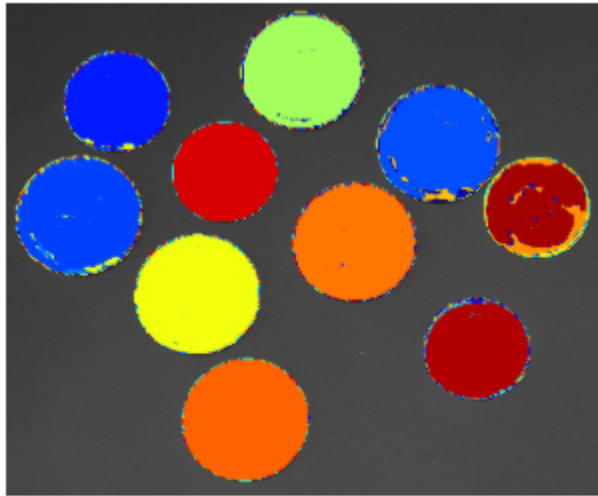

Input Arguments

I — Input image

M-by-*N* 2-D grayscale image

Input image, specified in grayscale. It must be real and nonsparse. The function internally converts input images to `uint8` that are not `uint8` before looking for MSER regions.

Data Types: `uint8` | `int16` | `uint16` | `single` | `double` | `logical`

Name-Value Pair Arguments

Specify optional comma-separated pairs of `Name`, `Value` arguments. `Name` is the argument name and `Value` is the corresponding value. `Name` must appear inside quotes. You can specify several name and value pair arguments in any order as `Name1`, `Value1`, ..., `NameN`, `ValueN`.

Example: `'RegionAreaRange', [30 14000]`, specifies the size of the region in pixels.

ThresholdDelta — Step size between intensity threshold levels

2 (default) | percent numeric value

Step size between intensity threshold levels, specified as the comma-separated pair consisting of `'ThresholdDelta'` and a numeric value in the range (0,100]. This value is expressed as a percentage of the input data type range used in selecting extremal regions while testing for their stability. Decrease this value to return more regions. Typical values range from 0.8 to 4.

RegionAreaRange — Size of the region

`[30 14000]` (default) | two-element vector

Size of the region in pixels, specified as the comma-separated pair consisting of 'RegionAreaRange' and a two-element vector. The vector, [*minArea maxArea*], allows the selection of regions containing pixels to be between *minArea* and *maxArea*, inclusive.

MaxAreaVariation — Maximum area variation between extremal regions

0.25 (default) | positive scalar

Maximum area variation between extremal regions at varying intensity thresholds, specified as the comma-separated pair consisting of 'MaxAreaVariation' and a positive scalar value. Increasing this value returns a greater number of regions, but they may be less stable. Stable regions are very similar in size over varying intensity thresholds. Typical values range from 0.1 to 1.0.

ROI — Rectangular region of interest

[1 1 size(I,2) size(I,1)] (default) | vector

Rectangular region of interest, specified as a vector. The vector must be in the format [*x y width height*]. When you specify an ROI, the function detects corners within the area located at [*x y*] of size specified by [*width height*]. The [*x y*] elements specify the upper left corner of the region.

Output Arguments

regions — MSER regions object

MSERegions object (default)

MSER regions object, returned as a MSERegions object. The object contains information about MSER features detected in the grayscale input image.

cc — Connected component structure

structure

Connected component structure, returned as a structure with four fields. The connected component structure is useful for measuring region properties using the `regionprops` function. The four fields:

Field	Description
Connectivity	Connectivity of the MSER regions. Default: 8
ImageSize	Size of I.
NumObjects	Number of MSER regions in I.
PixelIdxList	1-by-NumObjects cell array containing NumObjects vectors. Each vector represents the linear indices of the pixels in the element's corresponding MSER region.

Algorithms

Intensity Threshold Levels

The MSER detector incrementally steps through the intensity range of the input image to detect stable regions. The `ThresholdDelta` parameter determines the number of increments the detector tests for stability. You can think of the threshold delta value as the size of a cup to fill a bucket with water. The smaller the cup, the more number of increments it takes to fill up the bucket. The bucket can be thought of as the intensity profile of the region.

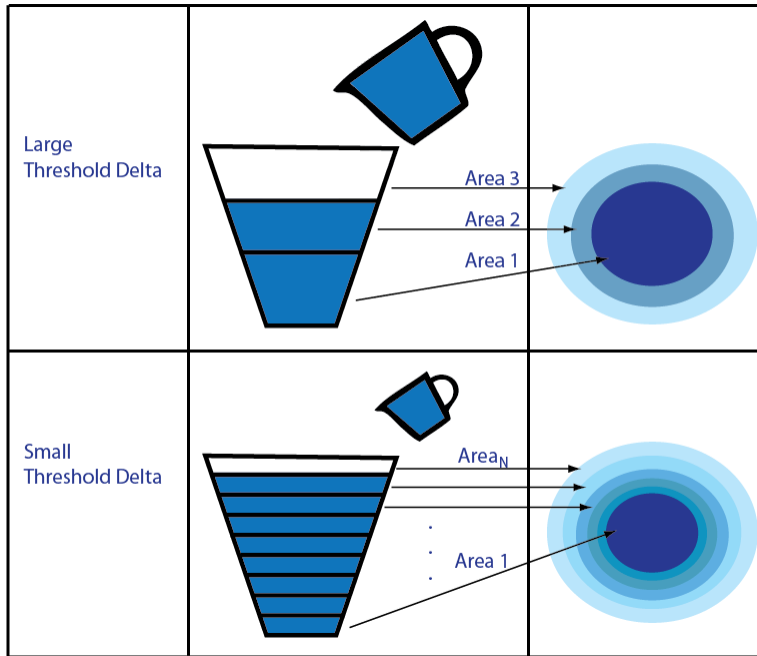

The MSER object checks the variation of the region area size between different intensity thresholds. The variation must be less than the value of the `MaxAreaVariation` parameter to be considered stable.

Note MSER feature detection is not suitable for use in images with extreme intensity value changes.

At a high level, MSER can be explained, by thinking of the intensity profile of an image representing a series of buckets. Imagine the tops of the buckets flush with the ground, and a hose turned on at one of the buckets. As the water fills into the bucket, it overflows and the next bucket starts filling up. Smaller regions of water join and become bigger bodies of water, and finally the whole area gets filled. As water is filling up into a bucket, it is checked against the MSER stability criterion. Regions appear, grow and merge at different intensity thresholds.

References

- [1] Nister, D., and H. Stewenius, "Linear Time Maximally Stable Extremal Regions", *Lecture Notes in Computer Science*. 10th European Conference on Computer Vision, Marseille, France: 2008, no. 5303, pp. 183-196.
- [2] Matas, J., O. Chum, M. Urba, and T. Pajdla. "Robust wide baseline stereo from maximally stable extremal regions." *Proceedings of British Machine Vision Conference*, pages 384-396, 2002.
- [3] Obdrzalek D., S. Basovnik, L. Mach, and A. Mikulik. "Detecting Scene Elements Using Maximally Stable Colour Regions," *Communications in Computer and Information Science*, La Ferte-Bernard, France; 2009, vol. 82 CCIS (2010 12 01), pp 107-115.
- [4] Mikolajczyk, K., T. Tuytelaars, C. Schmid, A. Zisserman, T. Kadir, and L. Van Gool, "A Comparison of Affine Region Detectors"; *International Journal of Computer Vision*, Volume 65, Numbers 1-2 / November, 2005, pp 43-72 .

Extended Capabilities

C/C++ Code Generation

Generate C and C++ code using MATLAB® Coder™.

Usage notes and limitations:

- Generates portable C code using a C++ compiler that links to OpenCV (Version 3.4.0) libraries. See “Portable C Code Generation for Functions That Use OpenCV Library”.
- For code generation, the function outputs `regions.PixelList` as an array. The region sizes are defined in `regions.Lengths`.
- For embedded real-time code generation support, you must enable the variable-size signals. **Code Generation > Interface** from the Configuration Parameters dialog box.

See Also

Functions

`detectSURFFeatures` | `detectMinEigenFeatures` | `detectBRISKFeatures` | `detectFASTFeatures` | `detectHarrisFeatures` | `detectKAZEFeatures` | `extractFeatures` | `extractHOGFeatures` | `detectFASTFeatures` | `matchFeatures`

Objects

`MSERRegions` | `SURFPoints` | `BRISKPoints` | `cornerPoints` | `binaryFeatures`

Topics

“Automatically Detect and Recognize Text in Natural Images”
“Point Feature Types”

Introduced in R2012a

detectPeopleACF

Detect people using aggregate channel features (ACF)

Note detectPeopleACF will be removed in a future release. Use peopleDetectorACF instead.

Syntax

```
bboxes = detectPeopleACF(I)
[bboxes,scores] = detectPeopleACF(I)
[ ___ ] = detectPeopleACF(I,roi)
[ ___ ] = detectPeopleACF(Name,Value)
```

Description

`bboxes = detectPeopleACF(I)` returns a matrix, `bboxes`, that contains the locations of detected upright people in the input image, `I`. The locations are represented as bounding boxes. The function uses the aggregate channel features (ACF) algorithm.

`[bboxes,scores] = detectPeopleACF(I)` also returns the detection scores for each bounding box.

`[___] = detectPeopleACF(I,roi)` detects people within the rectangular search region specified by `roi`, using either of the previous syntaxes.

`[___] = detectPeopleACF(Name,Value)` uses additional options specified by one or more `Name,Value` pair arguments. Unspecified properties have default values.

Code Generation Support:

Supports Code Generation: No

Supports MATLAB Function block: No

Code Generation Support, Usage Notes, and Limitations

Examples

Detect People Using Aggregated Channel Features

Read an image.

```
I = imread('visionteam1.jpg');
```

Detect people in the image and store results as bounding boxes and score.

```
[bboxes,scores] = detectPeopleACF(I);
```

Annotate the detected upright people in the image.

```
I = insertObjectAnnotation(I,'rectangle',bboxes,scores);
```

Display the results with annotation.

```
figure
imshow(I)
title('Detected people and detection scores')
```

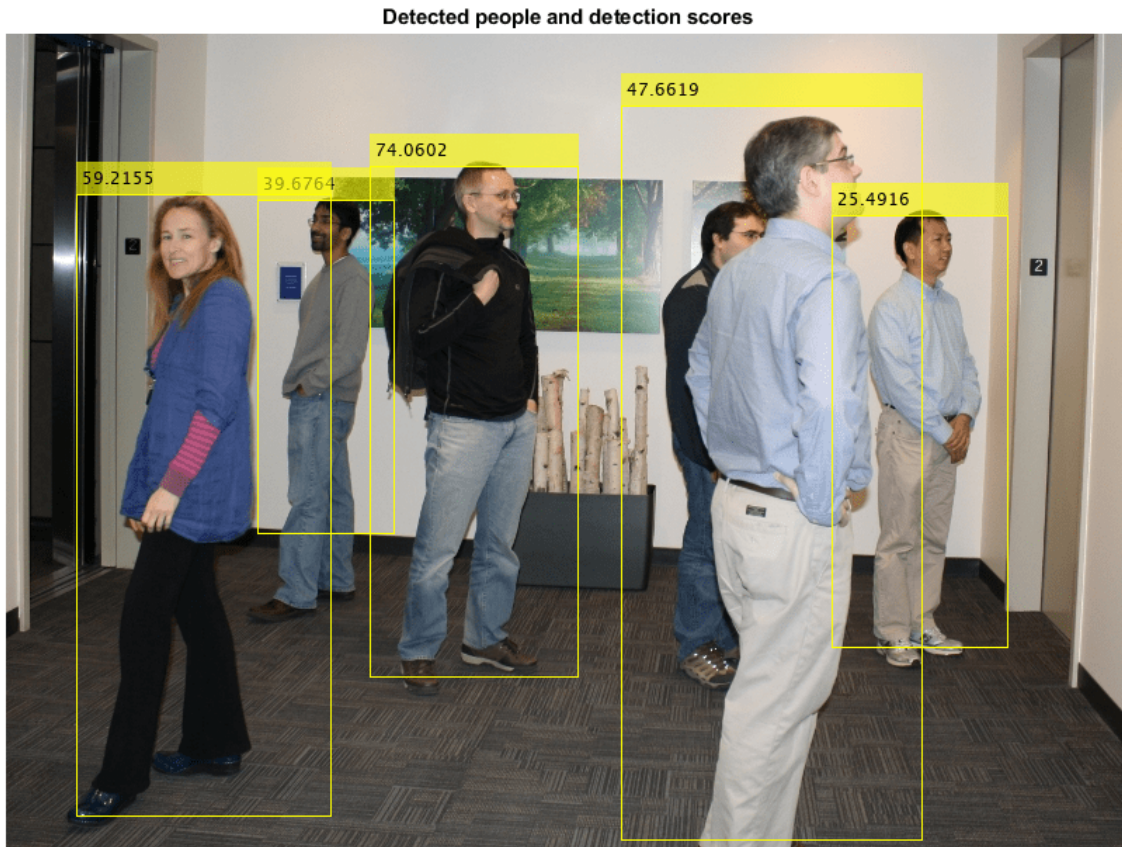

Input Arguments

I — Input image

truecolor image

Input image, specified as a truecolor image. The image must be real and nonsparse.

Data Types: uint8 | uint16 | int16 | double | single

roi — Rectangular search region

four-element vector

Rectangular search region, specified as a four-element vector, $[x,y,width,height]$. The `roi` must be fully contained in `I`.

Name-Value Pair Arguments

Specify optional comma-separated pairs of `Name`, `Value` arguments. `Name` is the argument name and `Value` is the corresponding value. `Name` must appear inside quotes. You can specify several name and value pair arguments in any order as `Name1, Value1, ..., NameN, ValueN`.

Example: `'Threshold', -1`

Model — ACF classification model

`'inria-100x41'` (default) | `'caltech-50x21'`

ACF classification model, specified as the comma-separated pair consisting of `'Model'` and either `'inria-100x41'` or `'caltech-50x21'`. The `'inria-100x41'` model was trained using the INRIA Person dataset. The `'caltech-50x21'` model was trained using the Caltech Pedestrian dataset.

NumScaleLevels — Number of scale levels per octave

8 (default) | integer

Number of scale levels per octave, specified as the comma-separated pair consisting of `'NumScaleLevels'`, and an integer. Each octave is a power-of-two downscaling of the image. Increase this number to detect people at finer scale increments. Recommended values are in the range [4,8].

WindowStride — Window stride for sliding window

4 (default) | integer

Window stride for sliding window, specified as the comma-separated pair consisting of `'WindowStride'`, and an integer. Set this value to the amount you want to move the window, in the `x` and `y` directions. The sliding window scans the images for object detection. The function uses the same stride for the `x` and `y` directions.

SelectStrongest — Select strongest bounding box

`true` (default) | `false`

Select strongest bounding box, specified as the comma-separated pair consisting of `'SelectStrongest'` and either `true` or `false`. The process, often referred to as nonmaximum suppression, eliminates overlapping bounding boxes based on their scores. Set this property to `true` to use the `selectStrongestBbox` function to select the strongest bounding box. Set this property to `false`, to perform a custom selection operation. Setting this property to `false` returns detected bounding boxes.

MinSize — Minimum region size

two-element vector [`height width`] | [50 21] | [100 41]

Minimum region size in pixels, specified as the comma-separated pair consisting of `'MinSize'`, and a two-element vector [`height width`]. You can set this property to [50 21] for the `'caltech-50x21'` model or [100 41] for the `'inria-100x41'` model. You can reduce computation time by setting this value to the known minimum region size for detecting a person. By default, `MinSize` is set to the smallest region size possible to detect an upright person for the classification model selected.

MaxSize — Maximum region size

`size(I)` (default) | two-element vector [`height width`]

Maximum region size in pixels, specified as the comma-separated pair consisting of `'MaxSize'`, and a two-element vector, [`height width`]. You can reduce computation time by setting this value to the

known region size for detecting a person. If you do not set this value, by default the function determines the height and width of the image using the size of `I`.

Threshold — Classification accuracy threshold

-1 (default) | numeric value

Classification accuracy threshold, specified as the comma-separated pair consisting of 'Threshold' and a numerical value. Typical values are in the range [-1,1]. During multiscale object detection, the threshold value controls the person or nonperson classification accuracy and speed. Increase this threshold to speed up the performance at the risk of missing true detections.

Output Arguments

bboxes — Locations of detected people

M-by-4 matrix

Locations of people detected using the aggregate channel features (ACF) algorithm, returned as an *M*-by-4 matrix. The locations are represented as bounding boxes. Each row in `bboxes` contains a four-element vector, `[x,y,width,height]`. This vector specifies the upper-left corner and size of a bounding box, in pixels, for a detected person.

scores — Confidence value

M-by-1 vector

Confidence value for the detections, returned as an *M*-by-1 vector. The vector contains a value for each bounding box in `bboxes`. The score for each detection is the output of a soft-cascade classifier. The range of score values is `[- inf inf]`. Greater scores indicate a higher confidence in the detection.

References

- [1] Dollar, P., R. Appel, S. Belongie, and P. Perona. "Fast feature pyramids for object detection." *Pattern Analysis and Machine Intelligence, IEEE Transactions*. Vol. 36, Issue 8, 2014, pp. 1532-1545.
- [2] Dollar, C. Wojek, B. Shiele, and P. Perona. "Pedestrian detection: An evaluation of the state of the art." *Pattern Analysis and Machine Intelligence, IEEE Transactions*. Vol. 34, Issue 4, 2012, pp. 743-761.
- [3] Dollar, C., Wojek, B. Shiele, and P. Perona. "Pedestrian detection: A benchmark." *IEEE Conference on Computer Vision and Pattern Recognition*. 2009.

See Also

Objects

`vision.CascadeObjectDetector` | `vision.PeopleDetector`

Functions

`selectStrongestBbox` | `peopleDetectorACF`

Topics

"Tracking Pedestrians from a Moving Car"
 "Point Feature Types"

Introduced in R2016a

detectSURFFeatures

Detect SURF features and return SURFPoints object

Syntax

```
points = detectSURFFeatures(I)  
points = detectSURFFeatures(I,Name,Value)
```

Description

`points = detectSURFFeatures(I)` returns a `SURFPoints` object, `points`, containing information about SURF features detected in the 2-D grayscale input image `I`. The `detectSURFFeatures` function implements the Speeded-Up Robust Features (SURF) algorithm to find blob features.

`points = detectSURFFeatures(I,Name,Value)` specifies options using one or more name-value arguments in addition to the input arguments in the previous syntax.

Examples

Detect SURF Interest Points in a Grayscale Image

Read image and detect interest points.

```
I = imread('cameraman.tif');  
points = detectSURFFeatures(I);
```

Display locations of interest in image.

```
imshow(I); hold on;  
plot(points.selectStrongest(10));
```



Input Arguments

I — Input image

M-by-*N* 2-D grayscale image

Input image, specified as an *M*-by-*N* 2-D grayscale. The input image must be a real non-sparse value.

Data Types: `single` | `double` | `int16` | `uint8` | `uint16` | `logical`

Name-Value Pair Arguments

Specify optional comma-separated pairs of `Name`, `Value` arguments. `Name` is the argument name and `Value` is the corresponding value. `Name` must appear inside quotes. You can specify several name and value pair arguments in any order as `Name1, Value1, ..., NameN, ValueN`.

Example: `detectSURFFeatures(I, 'MetricThreshold', 100)`

MetricThreshold — Strongest feature threshold

1000.0 (default) | non-negative scalar

Strongest feature threshold, specified as a non-negative scalar. To return more blobs, decrease the value of this threshold.

NumOctaves — Number of octaves

3 (default) | scalar (greater than or equal to 1)

Number of octaves, specified as an integer scalar, greater than or equal to 1. Increase this value to detect larger blobs. Recommended values are between 1 and 4.

Each octave spans a number of scales that are analyzed using varying size filters:

Octave	Filter Sizes
1	9-by-9, 15-by-15, 21-by-21, 27-by-27, ...
2	15-by-15, 27-by-27, 39-by-39, 51-by-51, ...
3	27-by-27, 51-by-51, 75-by-75, 99-by-99, ...
4

Higher octaves use larger filters and subsample the image data. Larger number of octaves result in finding larger size blobs. Set the `NumOctaves` parameter appropriately for the image size. For example, a 50-by-50 image require you to set the `NumOctaves` parameter, less than or equal to 2. The `NumScaleLevels` parameter controls the number of filters used per octave. At least three levels are required to analyze the data in a single octave.

NumScaleLevels — Number of scale levels per octave

4 (default) | integer scalar, greater than or equal to 3

Number of scale levels per octave to compute, specified as an integer scalar, greater than or equal to 3. Increase this number to detect more blobs at finer scale increments. Recommended values are between 3 and 6.

ROI — Rectangular region of interest

[1 1 size(I,2) size(I,1)] (default) | vector

Rectangular region of interest, specified as a vector. The vector must be in the format [*x y width height*]. When you specify an ROI, the function detects corners within the area at [*x y*] of size specified by [*width height*]. The [*x y*] elements specify the upper left corner of the region.

Output Arguments

points — SURF features

SURFPoints object

SURF features, returned as a SURFPoints object. This object contains information about SURF features detected in a grayscale image.

References

[1] Bay, H., A. Ess, T. Tuytelaars, and L. Van Gool. "SURF:Speeded Up Robust Features." *Computer Vision and Image Understanding (CVIU)*. Vol. 110, No. 3, pp. 346-359, 2008.

Extended Capabilities

C/C++ Code Generation

Generate C and C++ code using MATLAB® Coder™.

Usage notes and limitations:

- Generates portable C code using a C++ compiler that links to OpenCV (Version 3.4.0) libraries. See "Portable C Code Generation for Functions That Use OpenCV Library".

See Also

[detectBRISKFeatures](#) | [detectFASTFeatures](#) | [detectORBFeatures](#) |
[detectMinEigenFeatures](#) | [detectHarrisFeatures](#) | [detectMSERFeatures](#) |
[extractFeatures](#) | [matchFeatures](#) | [SURFPoints](#) | [ORBPoints](#)

Introduced in R2011b

detectORBFeatures

Detect ORB keypoints and return an `ORBPoints` object

Syntax

```
points = detectORBFeatures(I)
points = detectORBFeatures(I,Name,Value)
```

Description

`points = detectORBFeatures(I)` returns an `ORBPoints` object that contains information about ORB keypoints. The ORB keypoints are detected from the input image by using the Oriented FAST and rotated BRIEF (ORB) feature detection method.

`points = detectORBFeatures(I,Name,Value)` specifies options using one or more name-value pair arguments.

Examples

Detect ORB Keypoints in Grayscale Image

Read an image into the workspace.

```
I = imread('businessCard.png');
```

Convert the image into a grayscale image.

```
I = im2gray(I);
```

Display the grayscale image.

```
figure
imshow(I)
```

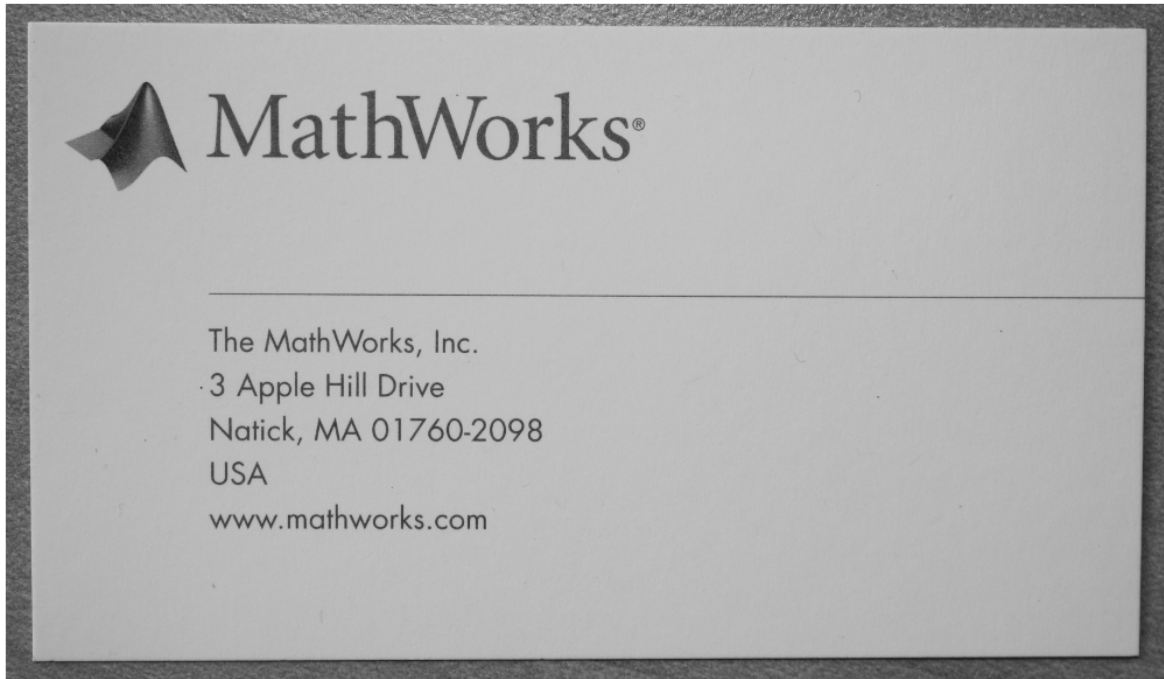

Detect and store ORB keypoints.

```
points = detectORBFeatures(I);
```

Display the grayscale image and plot the detected ORB keypoints. Suppress the display of circles around the detected keypoints. The ORB keypoints are detected in regions with high intensity variance.

```
figure  
imshow(I)  
hold on  
plot(points, 'ShowScale', false)  
hold off
```

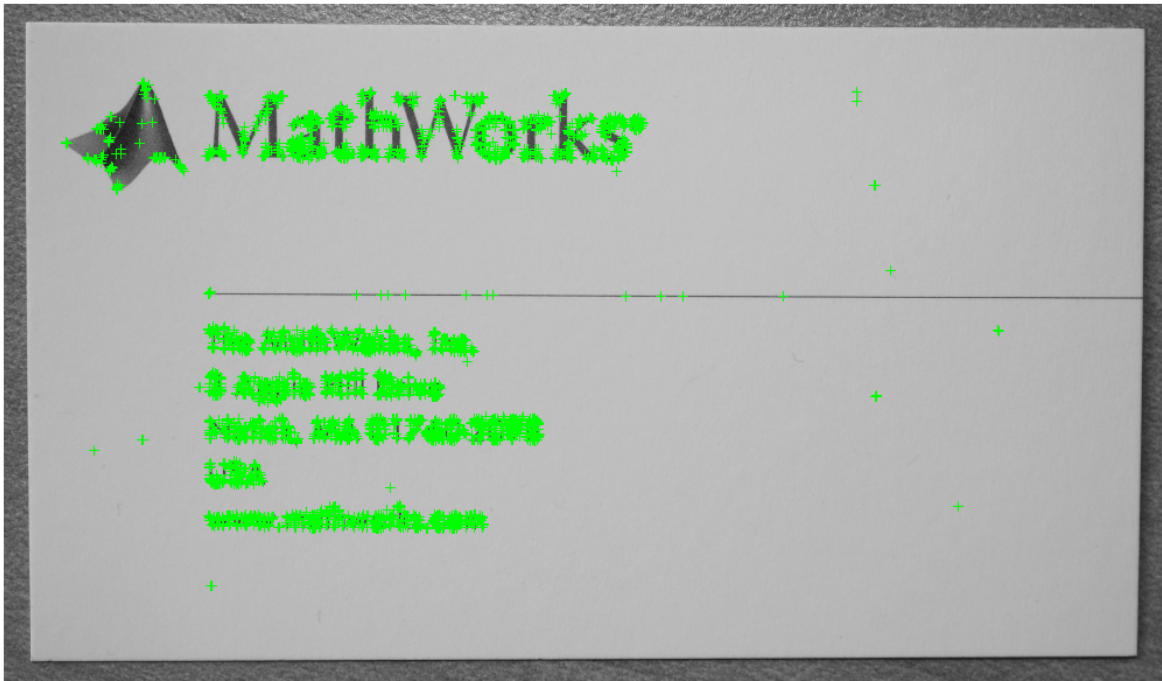

Detect ORB Keypoints In Binary Shape Image

Read a binary image into the workspace.

```
I = imread('star.png');
```

Display the image.

```
figure  
imshow(I)
```

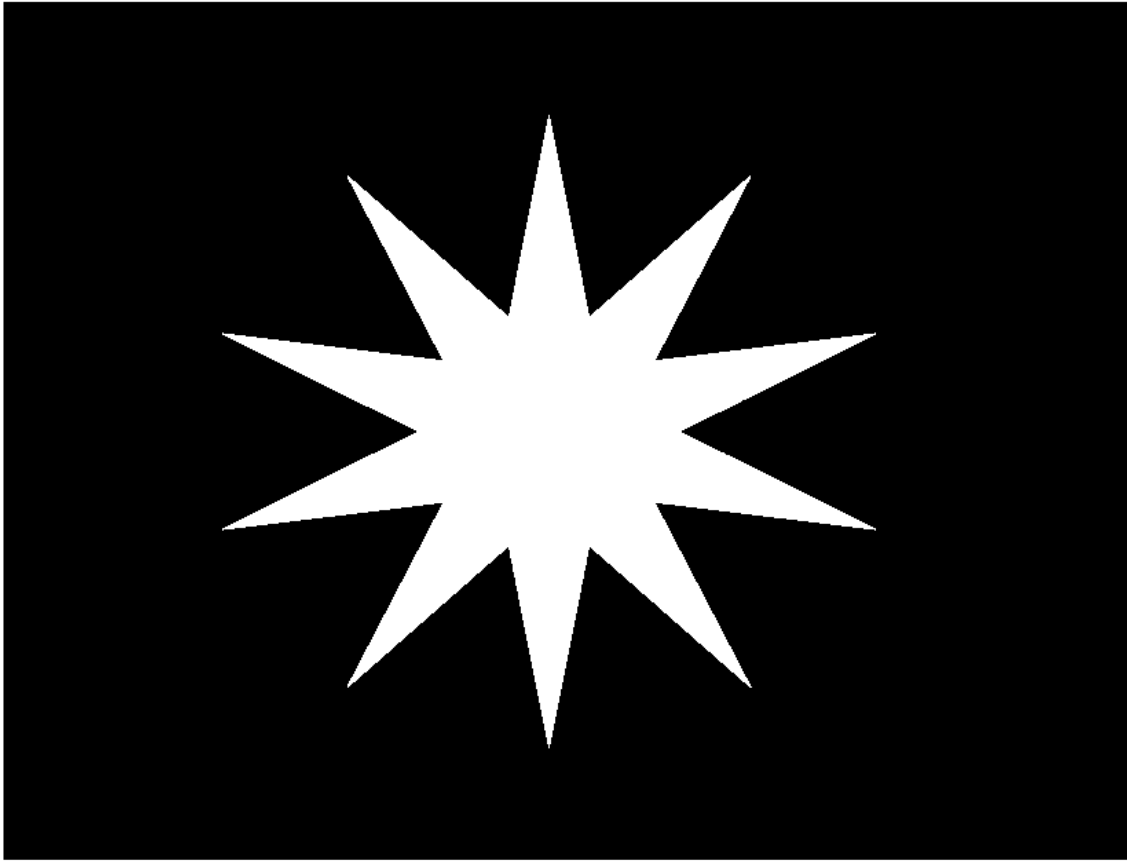

Detect and store ORB keypoints. Specify the scale factor for image decomposition as 1.01 and the number of decomposition levels as 3.

```
points = detectORBFeatures(I, 'ScaleFactor', 1.01, 'NumLevels', 3);
```

Display the image and plot the detected ORB keypoints. The inflection points in the binary shape image are detected as the ORB keypoints.

```
figure  
imshow(I)  
hold on  
plot(points)  
hold off
```

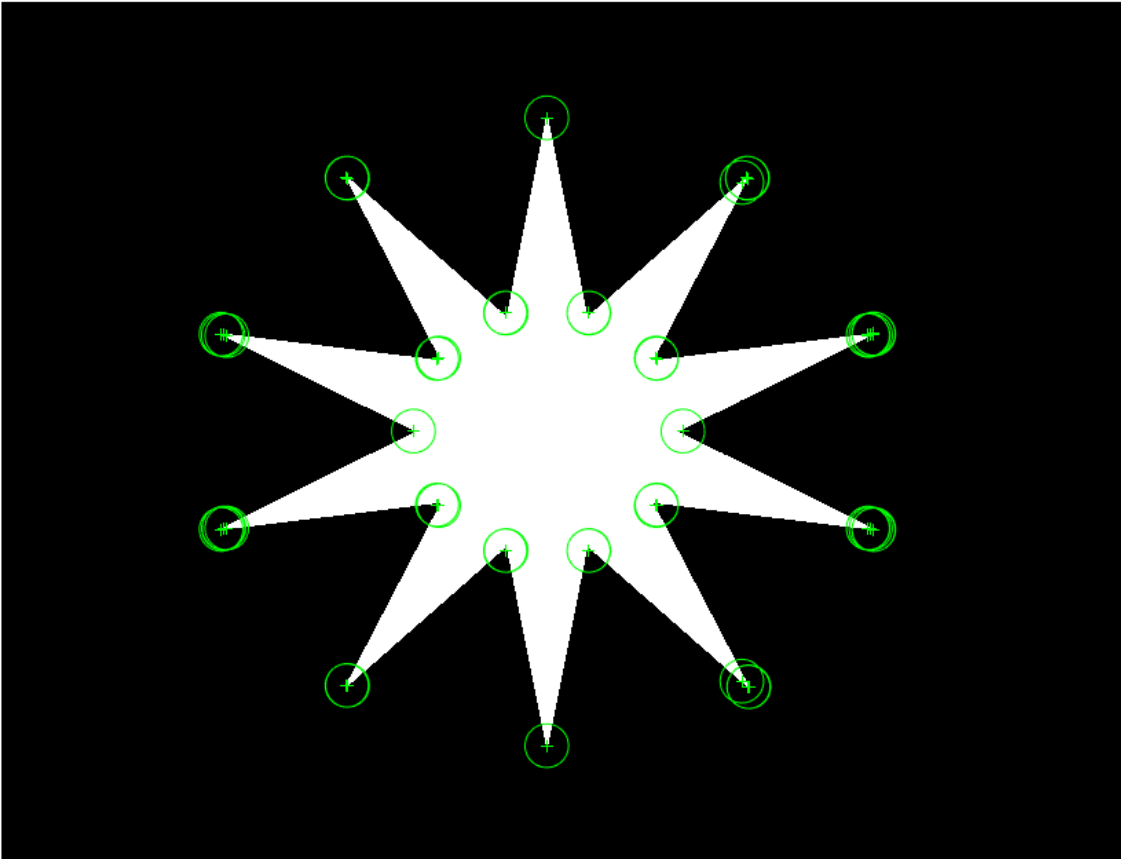

Input Arguments

I — Input image

M-by-*N* grayscale image

Input image, specified as an *M*-by-*N* grayscale image. The input image must be real and nonsparse.

Data Types: `single` | `double` | `int16` | `uint8` | `uint16` | `logical`

Name-Value Pair Arguments

Specify optional comma-separated pairs of `Name`, `Value` arguments. `Name` is the argument name and `Value` is the corresponding value. `Name` must appear inside quotes. You can specify several name and value pair arguments in any order as `Name1`, `Value1`, ..., `NameN`, `ValueN`.

Example: `detectORBFeatures(I, 'NumLevels', 4)`

ScaleFactor — Scale factor for image decomposition

1.2 (default) | scalar greater than 1

Scale factor for image decomposition, specified as the comma-separated pair consisting of 'ScaleFactor' and a scalar greater than 1. The scale value at each level of decomposition is $\text{ScaleFactor}^{(\text{level}-1)}$, where *level* is any value in the range [0, NumLevels-1]. Given the input image of size *M*-by-*N*, the image size at each level of decomposition is

$$\frac{M}{\text{ScaleFactor}^{(\text{level}-1)}} \text{-by-} \frac{N}{\text{ScaleFactor}^{(\text{level}-1)}}$$

Data Types: single | double | int8 | int16 | int32 | int64 | uint8 | uint16 | uint64 | uint32

NumLevels – Number of decomposition levels

8 (default) | scalar greater than or equal to 1

Number of decomposition levels, specified as the comma-separated pair consisting of 'NumLevels' and a scalar greater than or equal to 1. Increase this value to extract keypoints from the image at more levels of decomposition.

The number of decomposition levels for extracting keypoints is limited by the image size at that level. The image size at a level of decomposition must be at least 63-by-63 for detecting keypoints. The maximum level of decomposition is calculated as

$$\text{level}_{\max} = \text{floor}\left(\frac{\log(\min(M, N)) - \log(63)}{\log(\text{ScaleFactor})}\right) + 1$$

If either the default value or the specified value of 'NumLevels' is greater than level_{\max} , the function modifies NumLevels to level_{\max} and returns a warning.

Data Types: single | double | int8 | int16 | int32 | int64 | uint8 | uint16 | uint64 | uint32

ROI – Region of interest

[1 1 *M* *N*] (default) | four-element vector

Region of interest for keypoint detection, specified as the comma-separated pair consisting of 'ROI' and a vector of the format [*x* *y* *width* *height*]. The first two elements represent the location of the upper left corner of the region of interest. The last two elements represent the width and the height of the region of interest. The width and height of the region of interest must each be a value greater than or equal to 63.

Output Arguments

points – ORB keypoints

ORBPoints object

ORB keypoints, returned as an ORBPoints object. The object contains information about keypoints detected in the input image.

Algorithms

The function detects keypoints from the input image by using the ORB feature detection method in [1].

References

- [1] Rublee, E., V. Rabaud, K. Konolige, and G. Bradski. "ORB: An Efficient Alternative to SIFT or SURF." In *Proceedings of the 2011 International Conference on Computer Vision*, 2564–2571. Barcelona, Spain: IEEE, 2011.

Extended Capabilities

C/C++ Code Generation

Generate C and C++ code using MATLAB® Coder™.

See Also

[detectBRISKFeatures](#) | [detectHarrisFeatures](#) | [detectMinEigenFeatures](#) | [detectFASTFeatures](#) | [detectSURFFeatures](#) | [detectMSERFeatures](#) | [detectKAZEFeatures](#) | [ORBPoints](#) | [extractFeatures](#) | [matchFeatures](#)

Topics

"Point Feature Types"

"Local Feature Detection and Extraction"

Introduced in R2019a

disparity

(Not recommended) Disparity map between stereo images

Note `disparity` is not recommended. Use `disparityBM` or `disparitySGM` instead. For more information, see “Compatibility Considerations”

Syntax

```
disparityMap = disparity(I1,I2)
disparityMap = disparity(I1,I2,Name,Value)
```

Description

`disparityMap = disparity(I1,I2)` returns the disparity map, `disparityMap`, for a pair of stereo images, `I1` and `I2`.

`disparityMap = disparity(I1,I2,Name,Value)` provides additional control for the disparity algorithm by using one or more `Name,Value` pair arguments.

Examples

Compute Disparity Map for a Pair of Stereo Images

Load the images and convert them to grayscale.

```
I1 = imread('scene_left.png');
I2 = imread('scene_right.png');
```

Show stereo anaglyph. Use red-cyan stereo glasses to view image in 3-D.

```
figure
imshow(stereoAnaglyph(I1,I2));
title('Red-cyan composite view of the stereo images');
```

Red-cyan composite view of the stereo images



Compute the disparity map.

```
disparityRange = [-6 10];  
disparityMap = disparity(rgb2gray(I1), rgb2gray(I2), 'BlockSize', ...  
    15, 'DisparityRange', disparityRange);
```

Display the disparity map. For better visualization, use the disparity range as the display range for `imshow`.

```
figure  
imshow(disparityMap, disparityRange);  
title('Disparity Map');  
colormap(gca, jet)  
colorbar
```

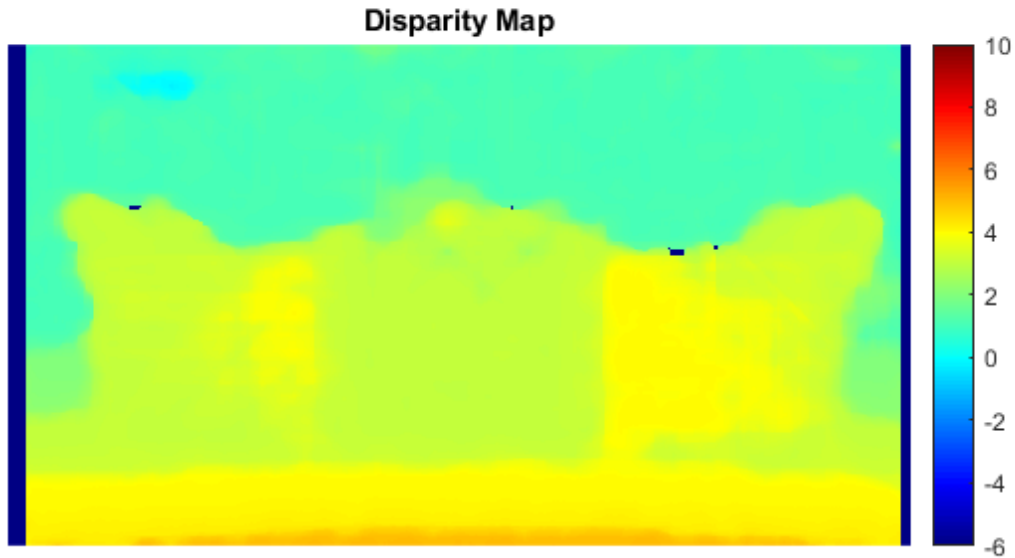

Input Arguments

I1 — Input image 1

M-by-*N* 2-D grayscale image

Input image referenced as I1 corresponding to camera 1, specified in 2-D grayscale. The stereo images, I1 and I2, must be rectified such that the corresponding points are located on the same rows. You can perform this rectification with the `rectifyStereoImages` function.

You can improve the speed of the function by setting the class of I1 and I2 to `uint8`, and the number of columns to be divisible by 4. Input images I1 and I2 must be real, finite, and nonsparse. They must be the same class.

Data Types: `uint8` | `uint16` | `int16` | `single` | `double`

I2 — Input image 2

M-by-*N* 2-D grayscale image

Input image referenced as I2 corresponding to camera 2, specified in 2-D grayscale. The input images must be rectified such that the corresponding points are located on the same rows. You can improve the speed of the function by setting the class of I1 and I2 to `uint8`, and the number of columns to be divisible by 4. Input images I1 and I2 must be real, finite, and nonsparse. They must be the same class.

Data Types: `uint8` | `uint16` | `int16` | `single` | `double`

Name-Value Pair Arguments

Specify optional comma-separated pairs of `Name`, `Value` arguments. `Name` is the argument name and `Value` is the corresponding value. `Name` must appear inside quotes. You can specify several name and value pair arguments in any order as `Name1, Value1, ..., NameN, ValueN`.

Example: `'Method', 'BlockMatching'`, specifies the `'Method'` property be set to `'BlockMatching'`.

Method — Disparity estimation algorithm

`'SemiGlobal'` (default) | `'BlockMatching'`

Disparity estimation algorithm, specified as the comma-separated pair consisting of `'Method'` and either `'BlockMatching'` or `'SemiGlobal'`. The disparity function implements the basic Block Matching [1] and the Semi-Global Block Matching [3] algorithms. In the `'BlockMatching'` method, the function computes disparity by comparing the sum of absolute differences (SAD) of each block of pixels in the image. In the `'SemiGlobal'` matching method, the function additionally forces similar disparity on neighboring blocks. This additional constraint results in a more complete disparity estimate than in the `'BlockMatching'` method.

The algorithms perform these steps:

- 1 Compute a measure of contrast of the image by using the Sobel filter.
- 2 Compute the disparity for each pixel in `I1`.
- 3 Mark elements of the disparity map, `disparityMap`, that were not computed reliably. The function uses `-realmax('single')` to mark these elements.

DisparityRange — Range of disparity

`[0 64]` (default) | two-element vector

Range of disparity, specified as the comma-separated pair consisting of `'DisparityRange'` and a two-element vector. The two-element vector must be in the format `[MinDisparity, MaxDisparity]`. Both elements must be an integer and can be negative. `MinDisparity` and `MaxDisparity` must be in the range `[-image width, image width]`. The difference between `MaxDisparity` and `MinDisparity` must be divisible by 16. `DisparityRange` must be real, finite, and nonsparse. If the camera used to take `I1` was to the right of the camera used to take `I2`, then `MinDisparity` must be negative.

The disparity range depends on the distance between the two cameras and the distance between the cameras and the object of interest. Increase the `DisparityRange` when the cameras are far apart or the objects are close to the cameras. To determine a reasonable disparity for your configuration, display the stereo anaglyph of the input images in the **Image Viewer** app and use the Distance tool to measure distances between pairs of corresponding points. Modify the `MaxDisparity` to correspond to the measurement.

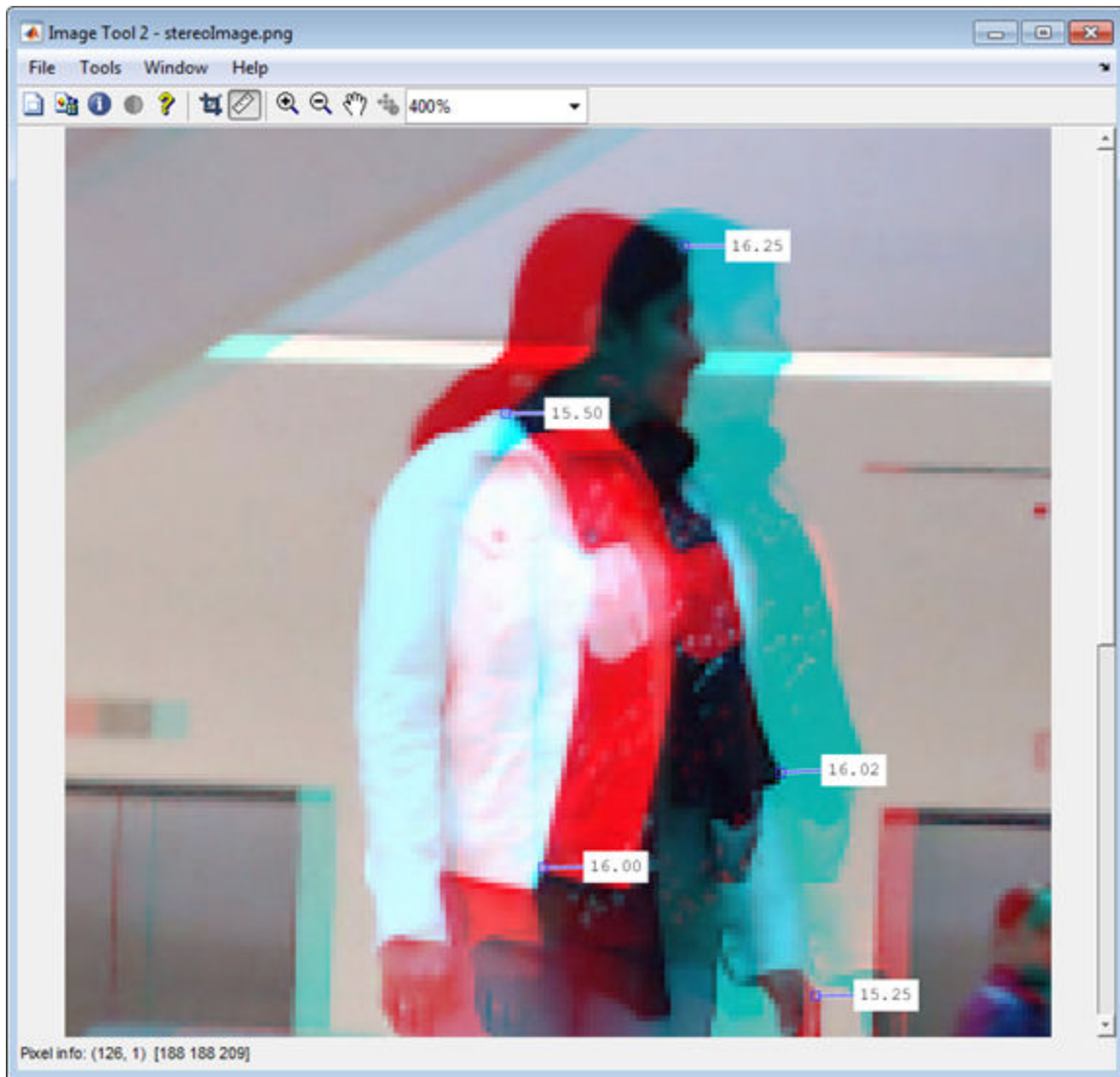
**BlockSize — Square block size**

15 (default) | odd integer

Square block size, specified as the comma-separated pair consisting of 'BlockSize' and an odd integer in the range [5,255]. This value sets the width for the square block size. The function uses the square block of pixels for comparisons between I1 and I2. BlockSize must be real, finite, and nonparse.

ContrastThreshold — Contrast threshold range

0.5 (default) | scalar value

Contrast threshold range, specified as the comma-separated pair consisting of 'ContrastThreshold' and a scalar value in the range (0,1]. The contrast threshold defines an acceptable range of contrast values. Increasing this parameter results in fewer pixels being marked as unreliable. ContrastThreshold must be real, finite, and nonparse.

UniquenessThreshold — Minimum value of uniqueness

15 (default) | non-negative integer

Minimum value of uniqueness, specified as the comma-separated pair consisting of 'UniquenessThreshold' and a nonnegative integer. Increasing this parameter results in the function marking more pixels unreliable. When the uniqueness value for a pixel is low, the disparity computed for it is less reliable. Setting the threshold to 0 disables uniqueness thresholding. UniquenessThreshold must be real, finite, and nonsparse.

The function defines uniqueness as a ratio of the optimal disparity estimation and the less optimal disparity estimation. For example:

Let K be the best estimated disparity, and let V be the corresponding SAD (Sum of Absolute Difference) value.

Consider V as the smallest SAD value over the whole disparity range, and v as the smallest SAD value over the whole disparity range, excluding K , $K-1$, and $K+1$.

If $v < V * (1 + 0.01 * \text{UniquenessThreshold})$, then the function marks the disparity for the pixel as unreliable.

DistanceThreshold — Maximum distance for left-to-right image checking

[] (disabled) (default) | non-negative integer

Maximum distance for left-to-right image checking between two points, specified as the comma-separated pair consisting of 'DistanceThreshold' and a nonnegative integer. Increasing this parameter results in fewer pixels being marked as unreliable. Conversely, when you decrease the value of the distance threshold, you increase the reliability of the disparity map. You can set this parameter to an empty matrix [] to disable it. DistanceThreshold must be real, finite, and nonsparse.

The distance threshold specifies the maximum distance between a point in I_1 and the same point found from I_2 . The function finds the distance and marks the pixel in the following way:

Let p_1 be a point in image I_1 .

Step 1: The function searches for point p_1 's best match in image I_2 (left-to-right check) and finds point p_2 .

Step 2: The function searches for p_2 's best match in image I_1 (right-to-left check) and finds point p_3 .

If the search returns a distance between p_1 and p_3 greater than DistanceThreshold, the function marks the disparity for the point p_1 as unreliable.

TextureThreshold — Minimum texture threshold

0.0002 (default) | scalar value

Minimum texture threshold, specified as the comma-separated pair consisting of 'TextureThreshold' and a scalar value in the range [0, 1). The texture threshold defines the minimum texture value for a pixel to be reliable. The lower the texture for a block of pixels, the less reliable the computed disparity is for the pixels. Increasing this parameter results in more pixels being marked as unreliable. You can set this parameter to 0 to disable it. This parameter applies only when you set Method to 'BlockMatching'.

The texture of a pixel is defined as the sum of the saturated contrast computed over the BlockSize-by-BlockSize window around the pixel. The function considers the disparity computed for the pixel unreliable and marks it, when the texture falls below the value defined by:

$$\text{Texture} < X * \text{TextureThreshold} * \text{BlockSize}^2$$

X represents the maximum value supported by the class of the input images, I_1 and I_2 .

TextureThreshold must be real, finite, and nonsparse.

Output Arguments

disparityMap — Disparity map

M-by-*N* 2-D grayscale image

Disparity map for a pair of stereo images, returned as an *M*-by-*N* 2-D grayscale image. The function returns the disparity map with the same size as the input images, **I1** and **I2**. Each element of the output specifies the disparity for the corresponding pixel in the image references as **I1**. The returned disparity values are rounded to $\frac{1}{16}$ th pixel.

The function computes the disparity map in three steps:

- 1** Compute a measure of contrast of the image by using the Sobel filter.
- 2** Compute the disparity for each of the pixels by using block matching and the sum of absolute differences (SAD).
- 3** Optionally, mark the pixels which contain unreliable disparity values. The function sets the pixel to the value returned by `-realmax('single')`.

Tips

If your resulting disparity map looks noisy, try modifying the `DisparityRange`. The disparity range depends on the distance between the two cameras and the distance between the cameras and the object of interest. Increase the `DisparityRange` when the cameras are far apart or the objects are close to the cameras. To determine a reasonable disparity for your configuration, display the stereo anaglyph of the input images in the **Image Viewer** app and use the Distance tool to measure distances between pairs of corresponding points. Modify the `MaxDisparity` to correspond to the measurement.

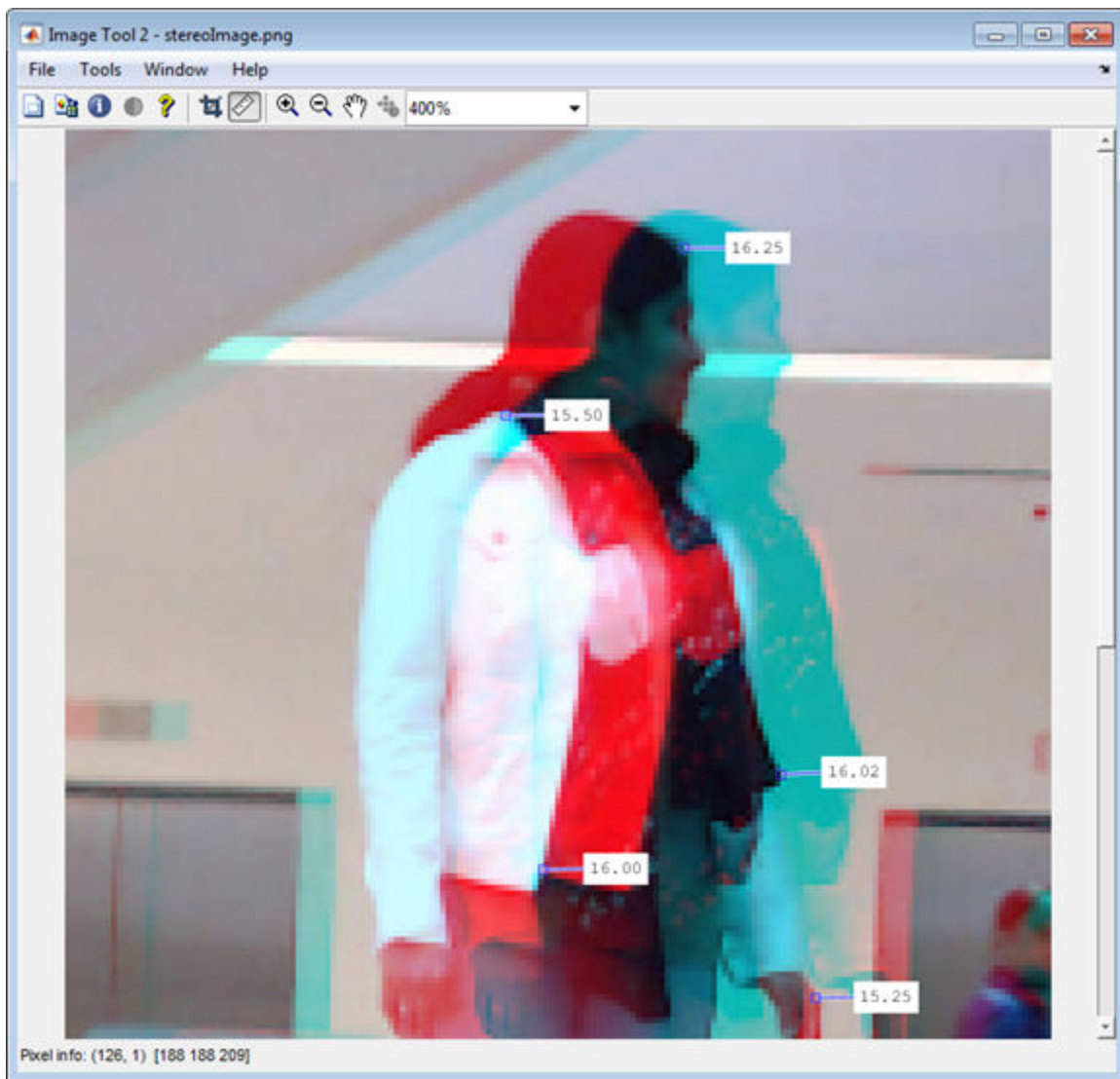

Compatibility Considerations

disparity function will be removed

Not recommended starting in R2019a

The disparity function will be removed in a future release. Use `disparityBM` or `disparitySGM` instead. Use `disparityBM` to compute disparity map using block matching method. Use `disparitySGM` to compute disparity map using semi-global matching method.

References

- [1] Konolige, K., *Small Vision Systems: Hardware and Implementation*, Proceedings of the 8th International Symposium in Robotic Research, pages 203-212, 1997.
- [2] Bradski, G. and A. Kaehler, *Learning OpenCV : Computer Vision with the OpenCV Library*, O'Reilly, Sebastopol, CA, 2008.

[3] Hirschmuller, H., *Accurate and Efficient Stereo Processing by Semi-Global Matching and Mutual Information*, International Conference on Computer Vision and Pattern Recognition, 2005.

Extended Capabilities

C/C++ Code Generation

Generate C and C++ code using MATLAB® Coder™.

Usage notes and limitations:

- 'Method' must be a compile-time constant.
- Generates portable C code using a C++ compiler that links to OpenCV (Version 3.4.0) libraries. See “Portable C Code Generation for Functions That Use OpenCV Library”.

See Also

Stereo Camera Calibrator | `reconstructScene` | `estimateUncalibratedRectification` | `rectifyStereoImages` | `estimateCameraParameters`

Topics

“Depth Estimation From Stereo Video”

“Structure From Motion From Two Views”

“Structure From Motion From Multiple Views”

“Uncalibrated Stereo Image Rectification”

Introduced in R2011b

disparityBM

Compute disparity map using block matching

Syntax

```
disparityMap = disparityBM(I1,I2)  
disparityMap = disparityBM(I1,I2,Name,Value)
```

Description

`disparityMap = disparityBM(I1,I2)` computes disparity map from a pair of rectified stereo images `I1` and `I2`, by using the block matching method. To know more about rectifying stereo images, see “Image Rectification” on page 3-450.

`disparityMap = disparityBM(I1,I2,Name,Value)` specifies options using one or more name-value pair arguments.

Examples

Compute Disparity Map by Using Block Matching Method

Load a rectified stereo pair image.

```
I1 = imread('rectified_left.png');  
I2 = imread('rectified_right.png');
```

Create the stereo anaglyph of the rectified stereo pair image and display it. You can view the image in 3-D by using red-cyan stereo glasses.

```
A = stereoAnaglyph(I1,I2);  
figure  
imshow(A)  
title('Red-Cyan composite view of the rectified stereo pair image')
```

Red-Cyan composite view of the rectified stereo pair image



Convert the rectified input color images to grayscale images.

```
J1 = im2gray(I1);  
J2 = im2gray(I2);
```

Compute the disparity map. Specify the range of disparity as [0, 48], and the minimum value of uniqueness as 20.

```
disparityRange = [0 48];  
disparityMap = disparityBM(J1,J2,'DisparityRange',disparityRange,'UniquenessThreshold',20);
```

Display the disparity map. Set the display range to the same value as the disparity range.

```
figure  
imshow(disparityMap,disparityRange)  
title('Disparity Map')  
colormap jet  
colorbar
```

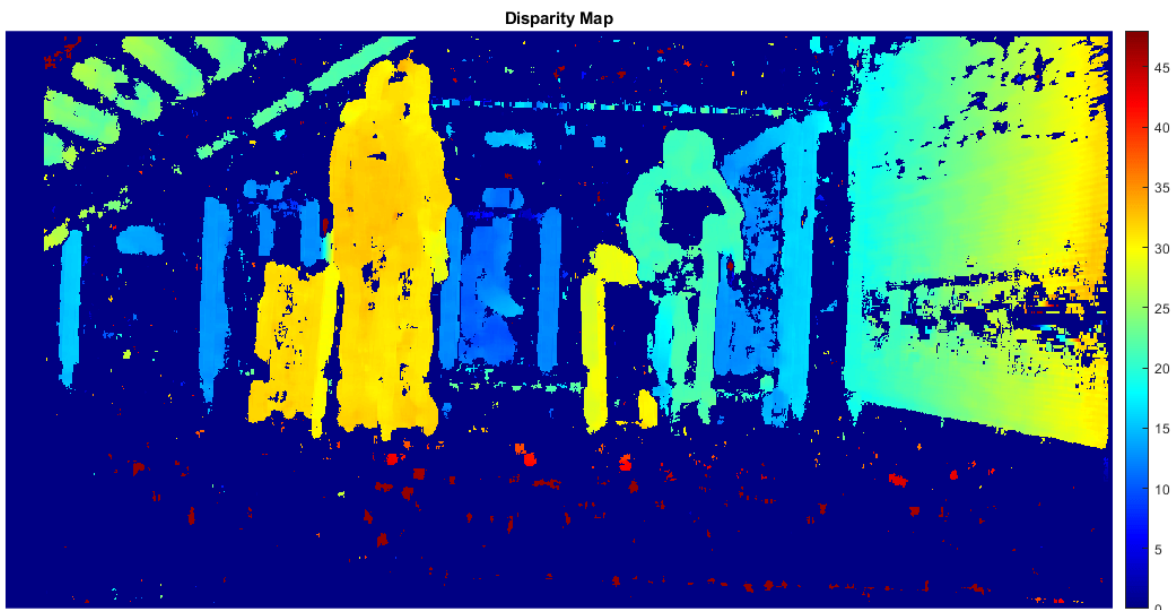

Input Arguments

I1 — Input image 1

2-D grayscale image | `gpuArray` object

Input image referenced as I1 corresponding to camera 1, specified as a 2-D grayscale image or a `gpuArray` object. The function uses this image as the reference image for computing the disparity map. The input images I1 and I2 must be real, finite, and nonsparse. Also, I1 and I2 must be of the same size and same data type.

Data Types: `single` | `double` | `int16` | `uint8` | `uint16`

I2 — Input image 2

2-D grayscale image | `gpuArray` object

Input image referenced as I2 corresponding to camera 2, specified as a 2-D grayscale image or a `gpuArray` object. The input images I1 and I2 must be real, finite, and nonsparse. I1 and I2 must be of the same size and same data type.

Data Types: `single` | `double` | `int16` | `uint8` | `uint16`

Name-Value Pair Arguments

Specify optional comma-separated pairs of `Name`, `Value` arguments. `Name` is the argument name and `Value` is the corresponding value. `Name` must appear inside quotes. You can specify several name and value pair arguments in any order as `Name1, Value1, ..., NameN, ValueN`.

Example: `disparityBM(I1,I2,'DisparityRange',[0 64])`

DisparityRange — Range of disparity

[0 64] (default) | two-element vector

Range of disparity, specified as the comma-separated pair consisting of 'DisparityRange' and a two-element vector of the form [*MinDisparity* *MaxDisparity*]. *MinDisparity* is the minimum disparity and *MaxDisparity* is the maximum disparity. The conditions this range must satisfy depend on the type of input images.

If the input images are grayscale images of width N , then:

- *MinDisparity* and *MaxDisparity* must be integers in the range $(-N, N)$.
- The difference between the *MaxDisparity* and *MinDisparity* values must be divisible by 16 and less than the width of the input images.

If the input images are `gpuArray` objects of width N , then:

- The value of *MinDisparity* must be equal to zero.

The value of *MaxDisparity* must be in the range $(16, N)$. If N is greater than 256, then the *MaxDisparity* must be chosen as less than or equal to 256.

The difference between the *MaxDisparity* and *MinDisparity* values must be divisible by 16.

The default value for the range of disparity is [0 64]. For more information on choosing the range of disparity, see “Choosing Range of Disparity” on page 3-450.

BlockSize — Size of squared block

15 (default) | odd integer

Size of the squared block, specified as the comma-separated pair consisting of 'BlockSize' and an odd integer. This value specifies the width of the search window used for block matching pixels in the rectified stereo pair image. The range for the size squared block depend on the type of input images.

If the input images are grayscale images, the 'BlockSize' value must be an odd integer in the range [5, 255].

If the input images are `gpuArray` objects, the 'BlockSize' value must be an odd integer in the range [5, 51].

The default value is 15.

ContrastThreshold — Range of contrast threshold

0.5 (default) | scalar in the range (0, 1]

Range of contrast threshold, specified as the comma-separated pair consisting of 'ContrastThreshold' and a scalar value in the range (0, 1]. The contrast threshold defines an acceptable range of contrast values. If the contrast value of a pixel in the reference image is below the contrast threshold, then the disparity computed for that pixel is considered unreliable. Increasing this parameter results in disparity for fewer pixels being marked as unreliable.

UniquenessThreshold — Minimum value of uniqueness

15 (default) | nonnegative integer

Minimum value of uniqueness, specified as the comma-separated pair consisting of 'UniquenessThreshold' and a nonnegative integer.

The function marks the estimated disparity value K for a pixel as unreliable, if:

$$v < V \times (1 + 0.01 \times \text{UniquenessThreshold}),$$

where V is the sum of absolute difference (SAD) corresponding to the disparity value K . v is the smallest SAD value over the whole disparity range, excluding K , $K-1$, and $K+1$.

Increasing the value of `UniquenessThreshold` results in disparity values for more pixels being marked as unreliable. To disable the use of uniqueness threshold, set this value to `[]`.

Note If the input images are `gpuArray` objects, then the 'UniquenessThreshold' name-value pair argument does not apply.

DistanceThreshold — Maximum distance between conjugate pixels in stereo pair image
`[]` (disabled) (default) | nonnegative integer

Maximum distance between conjugate pixels in stereo pair image, specified as the comma-separated pair consisting of 'DistanceThreshold' and a nonnegative integer. The distance threshold specifies the maximum distance between a pixel in `I1` and the same pixel found in `I2`.

For pixel p_1 in the reference image `I1`, the function performs a left-to-right check to find its best matching pixel p_2 in image `I2`. For pixel p_2 , the function performs a right-to-left check to find its best matching pixel p_3 in the reference image `I1`. If the distance between p_1 and p_3 is greater than the `DistanceThreshold`, the function marks the disparity for the pixel p_1 in the reference image `I1` as unreliable.

Increasing the value of `DistanceThreshold` results in disparity values for fewer pixels being marked as unreliable. Conversely, decreasing the value of `DistanceThreshold`, increases the reliability of the disparity map. To disable the use of distance threshold, set this value to `[]`.

Note If the input images are `gpuArray` objects, then the 'DistanceThreshold' name-value pair argument does not apply.

TextureThreshold — Minimum texture threshold
`0.0002` (default) | scalar value in the range [0, 1)

Minimum texture threshold, specified as the comma-separated pair consisting of 'TextureThreshold' and a scalar value in the range [0, 1).

The texture of a pixel is defined as the sum of the saturated contrast computed over the `BlockSize-by-BlockSize` window around the pixel. The texture threshold defines the minimum texture value for a pixel to have reliable disparity value. The function considers the disparity for a pixel as unreliable, if:

$$\text{texture} < \text{intensity}_{\max} \times \text{TextureThreshold} \times \text{BlockSize}^2,$$

where texture is the texture of a pixel. intensity_{\max} is the maximum value supported by the data type of input images `I1` and `I2`.

Increasing the value of 'TextureThreshold' results in disparity values for more pixels being marked as unreliable. To disable the use of texture threshold, set this value to `[]`.

Output Arguments

disparityMap — Disparity map

2-D grayscale image | gpuArray object

Disparity map for rectified stereo pair image, returned as a 2-D grayscale image or a `gpuArray` object. The function returns the disparity map with the same size as input images `I1` and `I2`. Each value in this output refers to the displacement between conjugate pixels in the stereo pair image. For details about computing the disparity map, see “Computing Disparity Map Using Block Matching” on page 3-451.

Data Types: `single`

More About

Image Rectification

The input images `I1` and `I2` must be rectified before computing the disparity map. The rectification ensures that the corresponding points in the stereo pair image are on the same rows. You can rectify the input stereo pair image by using the `rectifyStereoImages` function. The reference image must be the same for rectification and disparity map computation.

Algorithms

Choosing Range of Disparity

The range of disparity must be chosen to cover the minimum and the maximum amount of horizontal shift between the corresponding pixels in the rectified stereo pair image. You can determine the approximate horizontal shift values from the stereo anaglyph of the stereo pair image. Compute the stereo anaglyph of the rectified images by using the `stereoAnaglyph` function. Display the stereo anaglyph in the **Image Viewer** app. To measure the amount of horizontal shift between the corresponding points in the stereo pair image, select **Measure Distance** from the **Tools** menu in **Image Viewer**. Choose the minimum and maximum disparity values for the range of disparity based on this measurement.

For example, this figure displays the stereo anaglyph of a rectified stereo pair image and the horizontal shift values measured between the corresponding points in the stereo pair image. The minimum and maximum shift values are computed as 8 and 31 respectively. Based on these values, the range of disparity can be chosen as `[0, 48]`.



Computing Disparity Map Using Block Matching

The function computes the disparity map by following these steps:

- 1 Compute the disparity for each pixel by using the block matching method given in [1].
 - For CPU — The sum of absolute difference (SAD) is used as the cost function in block matching. The cost function estimates the displacement between pixels in the rectified stereo pair image.
 - For GPU — The sum of squared difference (SSD) is used as the cost function in block matching. The cost function estimates the displacement between pixels in the rectified stereo pair image.
- 2 Optionally, mark the pixels for unreliability based on the ContrastThreshold, UniquenessThreshold, DistanceThreshold, and TextureThreshold name-value pairs. The function sets the unreliable disparity values to NaN.

References

- [1] Konolige, K. "Small Vision Systems: Hardware and Implementation." In *Proceedings of the 8th International Symposium in Robotic Research*, pp. 203–212. 1997.
- [2] Bradski, G. and A. Kaehler. *Learning OpenCV : Computer Vision with the OpenCV Library*. Sebastopol, CA: O'Reilly Media, Inc. 2008.

Extended Capabilities

C/C++ Code Generation

Generate C and C++ code using MATLAB® Coder™.

- Supports code generation only in generic MATLAB Host Computer target platform.

GPU Arrays

Accelerate code by running on a graphics processing unit (GPU) using Parallel Computing Toolbox™.

- GPU support will be removed in a future release.
- The maximum disparity value supported for `gpuArray` objects is 256.

For more information, see “Run MATLAB Functions on a GPU” (Parallel Computing Toolbox).

See Also

Apps

Stereo Camera Calibrator

Functions

`disparitySGM` | `reconstructScene` | `estimateUncalibratedRectification` | `rectifyStereoImages` | `estimateCameraParameters`

Introduced in R2019a

disparitySGM

Compute disparity map through semi-global matching

Syntax

```
disparityMap = disparitySGM(I1,I2)
disparityMap = disparitySGM(I1,I2,Name,Value)
```

Description

`disparityMap = disparitySGM(I1,I2)` computes disparity map from a pair of rectified stereo images `I1` and `I2`, by using semi-global matching (SGM) method. To know more about rectifying stereo images, see “Image Rectification” on page 3-456.

`disparityMap = disparitySGM(I1,I2,Name,Value)` specifies options using one or more name-value pair arguments.

Examples

Compute Disparity Map by Using Semi-Global Matching Method

Load a rectified stereo pair image.

```
I1 = imread('rectified_left.png');
I2 = imread('rectified_right.png');
```

Create the stereo anaglyph of the rectified stereo pair image and display it. You can view the image in 3-D by using red-cyan stereo glasses.

```
A = stereoAnaglyph(I1,I2);
figure
imshow(A)
title('Red-Cyan composite view of the rectified stereo pair image')
```

Red-Cyan composite view of the rectified stereo pair image



Convert the rectified input color images to grayscale images.

```
J1 = rgb2gray(I1);  
J2 = rgb2gray(I2);
```

Compute the disparity map through semi-global matching. Specify the range of disparity as [0, 48], and the minimum value of uniqueness as 20.

```
disparityRange = [0 48];  
disparityMap = disparitySGM(J1,J2, 'DisparityRange',disparityRange, 'UniquenessThreshold',20);
```

Display the disparity map. Set the display range to the same value as the disparity range.

```
figure  
imshow(disparityMap,disparityRange)  
title('Disparity Map')  
colormap jet  
colorbar
```

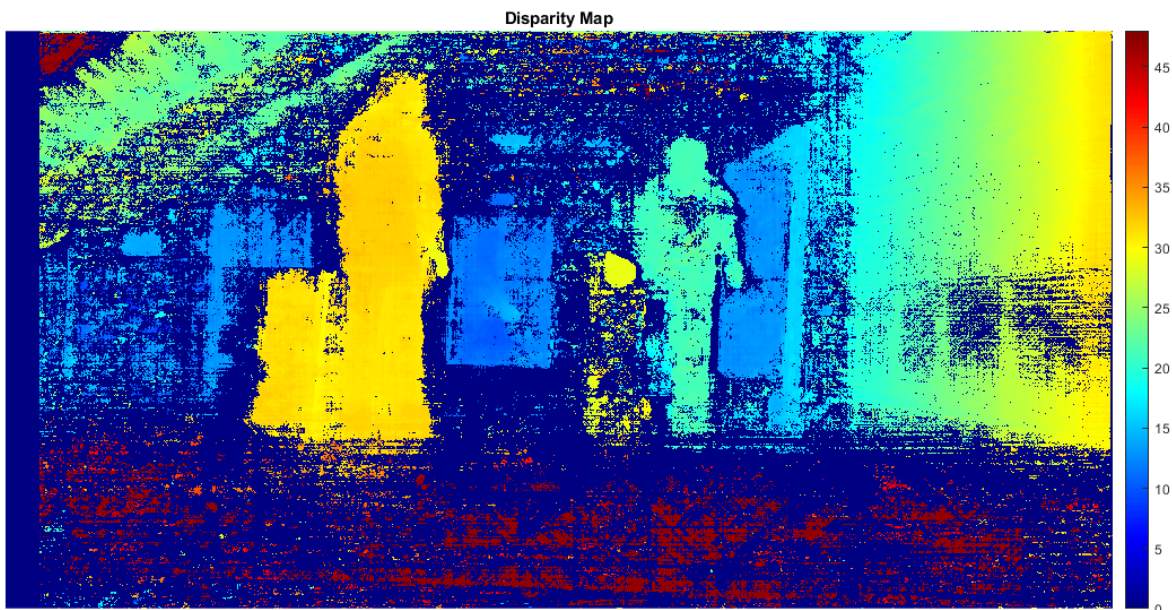

Input Arguments

I1 — Input image 1

2-D grayscale image | `gpuArray` object

Input image referenced as I1 corresponding to camera 1, specified as a 2-D grayscale image or a `gpuArray` object. The function uses this image as the reference image for computing the disparity map. The input images I1 and I2 must be real, finite, and nonsparse. Also, I1 and I2 must be of the same size and same data type.

Data Types: `single` | `double` | `int16` | `uint8` | `uint16`

I2 — Input image 2

2-D grayscale image | `gpuArray` object

Input image referenced as I2 corresponding to camera 2, specified as a 2-D grayscale image or a `gpuArray` object. The input images I1 and I2 must be real, finite, and nonsparse. I1 and I2 must be of the same size and same data type.

Data Types: `single` | `double` | `int16` | `uint8` | `uint16`

Name-Value Pair Arguments

Specify optional comma-separated pairs of `Name`, `Value` arguments. `Name` is the argument name and `Value` is the corresponding value. `Name` must appear inside quotes. You can specify several name and value pair arguments in any order as `Name1, Value1, ..., NameN, ValueN`.

Example: `disparitySGM(I1,I2,'DisparityRange',[0 64])`

DisparityRange — Range of disparity

[0 128] (default) | two-element vector

Range of disparity, specified as the comma-separated pair consisting of 'DisparityRange' and a two-element vector of the form [*MinDisparity* *MaxDisparity*]. *MinDisparity* is the minimum disparity and *MaxDisparity* is the maximum disparity.

For input images of width N , the *MinDisparity* and *MaxDisparity* must be integers in the range $(-N, N)$. The difference between the *MaxDisparity* and *MinDisparity* values must be divisible by 8 and must be less than or equal to 128.

The default value for the range of disparity is [0 128]. For more information on choosing the range of disparity, see “Choosing Range of Disparity” on page 3-457.

Data Types: integers

UniquenessThreshold — Minimum value of uniqueness

15 (default) | non-negative integer

Minimum value of uniqueness, specified as the comma-separated pair consisting of 'UniquenessThreshold' and a nonnegative integer.

The function marks the estimated disparity value K for a pixel as unreliable, if:

$$v < V \times (1 + 0.01 \times \text{UniquenessThreshold}),$$

where V is the Hamming distance corresponding to the disparity value K . v is the smallest Hamming distance value over the whole disparity range, excluding K , $K-1$, and $K+1$.

Increasing the value of `UniquenessThreshold` results in disparity values for more pixels being marked as unreliable. To disable the use of uniqueness threshold, set this value to 0.

Output Arguments**disparityMap — Disparity map**

2-D grayscale image | gpuArray object

Disparity map for rectified stereo pair image, returned as a 2-D grayscale image or a `gpuArray` object. The function returns the disparity map with the same size as input images `I1` and `I2`. Each value in this output refers to the displacement between conjugate pixels in the stereo pair image. For details about computing the disparity map, see “Computing Disparity Map Using Semi-Global Matching” on page 3-458.

Data Types: single

More About**Image Rectification**

The input images `I1` and `I2` must be rectified before computing the disparity map. The rectification ensures that the corresponding points in the stereo pair image are on the same rows. You can rectify the input stereo pair image by using the `rectifyStereoImages` function. The reference image must be the same for rectification and disparity map computation.

Algorithms

Choosing Range of Disparity

The range of disparity must be chosen to cover the minimum and the maximum amount of horizontal shift between the corresponding pixels in the rectified stereo pair image. You can determine the approximate horizontal shift values from the stereo anaglyph of the stereo pair image. Compute the stereo anaglyph of the rectified images by using the `stereoAnaglyph` function. Display the stereo anaglyph in the **Image Viewer** app. To measure the amount of horizontal shift between the corresponding points in the stereo pair image, select **Measure Distance** from the **Tools** menu in **Image Viewer**. Choose the minimum and maximum disparity values for the range of disparity based on this measurement.

For example, this figure displays the stereo anaglyph of a rectified stereo pair image and the horizontal shift values measured between the corresponding points in the stereo pair image. The minimum and maximum shift values are computed as 8 and 31 respectively. Based on these values, the range of disparity can be chosen as [0, 48].



Computing Disparity Map Using Semi-Global Matching

- 1 Compute Census transform of the rectified stereo pair image.
- 2 Compute Hamming distance between pixels in the census-transformed image to obtain the matching cost matrix.
- 3 Compute the pixel-wise disparity from matching cost matrix by using the semi-global matching method given in [1].
- 4 Optionally, mark the pixels for unreliability based on the `UniquenessThreshold` name-value pair. The function sets the disparity values of the unreliable pixels to NaN.

References

- [1] Hirschmuller, H. "Accurate and Efficient Stereo Processing by Semi-Global Matching and Mutual Information." In *Proceedings of the IEEE Conference on Computer Vision and Pattern Recognition (CVPR)*, pp. 807-814. San Diego, CA: IEEE, 2005.

Extended Capabilities

C/C++ Code Generation

Generate C and C++ code using MATLAB® Coder™.

Usage notes and limitations:

- The name-value pair arguments, 'DisparityRange' and 'UniquenessThreshold' must be compile-time constants.
- Supports code generation only in generic MATLAB Host Computer target platform.

GPU Code Generation

Generate CUDA® code for NVIDIA® GPUs using GPU Coder™.

Usage notes and limitations:

- The input images I1 and I2 must be rectified, same size, and of same data type.
- GPU code generation supports the 'UniquenessThreshold' and 'disparityMap' name-value pairs.
- For very large inputs, the memory requirements of the algorithm may exceed the GPU device limits. In such cases, consider reducing the input size to proceed with code generation.

GPU Arrays

Accelerate code by running on a graphics processing unit (GPU) using Parallel Computing Toolbox™.

This function fully supports GPU arrays. For more information, see "Run MATLAB Functions on a GPU" (Parallel Computing Toolbox).

See Also

Apps

Stereo Camera Calibrator

Functions

disparityBM | reconstructScene | estimateUncalibratedRectification |
rectifyStereoImages | estimateCameraParameters

Introduced in R2019a

epipolarLine

Compute epipolar lines for stereo images

Syntax

```
lines = epipolarLine(F,points)
lines = epipolarLine(F',points)
```

Description

`lines = epipolarLine(F,points)` returns an M -by-3 matrix, `lines`. The matrix represents the computed epipolar lines in image I2 corresponding to the points in image I1. The input `F` represents the fundamental matrix that maps points in I1 to epipolar lines in image I2.

`lines = epipolarLine(F',points)` The matrix represents the computed epipolar lines in image I1 corresponding to the points in image I2.

Examples

Compute Fundamental Matrix

This example shows you how to compute the fundamental matrix. It uses the least median of squares method to find the inliers.

The points, `matched_points1` and `matched_points2`, have been putatively matched.

```
load stereoPointPairs
[fLMedS,inliers] = estimateFundamentalMatrix(matchedPoints1,...
    matchedPoints2,'NumTrials',4000);
```

Show the inliers in the first image.

```
I1 = imread('viprectification_deskLeft.png');
figure;
subplot(121);
imshow(I1);
title('Inliers and Epipolar Lines in First Image'); hold on;
plot(matchedPoints1(inliers,1),matchedPoints1(inliers,2),'go')
```

Inliers and Epipolar Lines in First Image

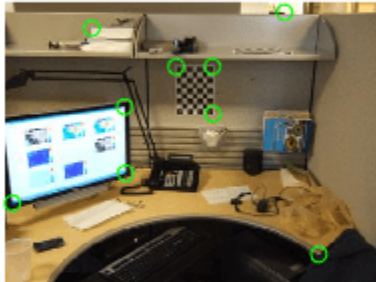

Compute the epipolar lines in the first image.

```
epiLines = epipolarLine(fLMedS',matchedPoints2(inliers,:));
```

Compute the intersection points of the lines and the image border.

```
points = lineToBorderPoints(epiLines,size(I1));
```

Show the epipolar lines in the first image

```
line(points(:,[1,3])',points(:,[2,4])');
```

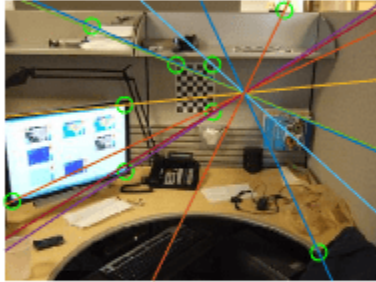
Inliers and Epipolar Lines in First Image

Show the inliers in the second image.

```
I2 = imread('viprectification_deskRight.png');  
subplot(122);  
imshow(I2);  
title('Inliers and Epipolar Lines in Second Image'); hold on;  
plot(matchedPoints2(inliers,1),matchedPoints2(inliers,2),'go')
```

Inliers and Epipolar Lines in First Image Inliers and Epipolar Lines in Second Image

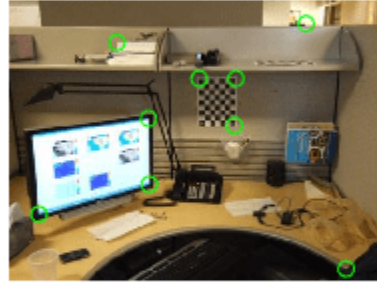
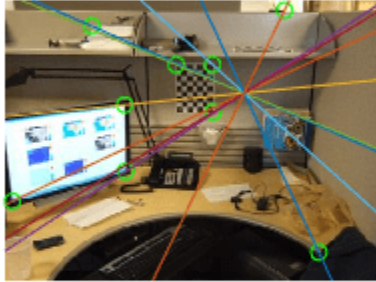

Compute and show the epipolar lines in the second image.

```
epiLines = epipolarLine(fLMedS,matchedPoints1(inliers,:));
points = lineToBorderPoints(epiLines,size(I2));
line(points(:,[1,3])',points(:,[2,4])');
truesize;
```

Inliers and Epipolar Lines in First Image

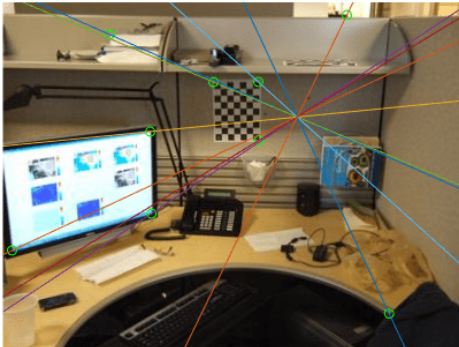

Inliers and Epipolar Lines in Second Image



Input Arguments

F — Fundamental matrix

3-by-3 matrix (default)

Fundamental matrix, specified as a 3-by-3 matrix. **F** must be double or single. If P_1 represents a point in the first image I_1 that corresponds to P_2 , a point in the second image I_2 , then:

$$[P_2, 1] * F * [P_1, 1]' = 0$$

In computer vision, the fundamental matrix is a 3-by-3 matrix which relates corresponding points in stereo images. When two cameras view a 3-D scene from two distinct positions, there are a number of geometric relations between the 3-D points and their projections onto the 2-D images that lead to constraints between the image points. Two images of the same scene are related by epipolar geometry.

F' — Fundamental matrix

3-by-3 matrix (default)

Fundamental matrix, specified as a 3-by-3 matrix. The **F'** fundamental matrix maps points in image I_2 to epipolar lines in image I_1 .

points — Coordinates of points

M

Coordinates of points, specified as an M -by-2 matrix. Each row contains the (x,y) coordinates of a point. M is the number of points.

Output Arguments

lines — Lines

M -by-3 matrix

An M -by-3 matrix, where each row must be in the format, $[A,B,C]$. This corresponds to the definition of the line:

$$A * x + B * y + C = 0.$$

M represents the number of lines.

Extended Capabilities

C/C++ Code Generation

Generate C and C++ code using MATLAB® Coder™.

See Also

[insertShape](#) | [size](#) | [line](#) | [isEpipoleInImage](#) | [lineToBorderPoints](#) | [estimateFundamentalMatrix](#)

Topics

“Structure From Motion From Two Views”

“Structure From Motion From Multiple Views”

Introduced in R2011a

estimateCameraParameters

Calibrate a single or stereo camera

Syntax

```
[cameraParams,imagesUsed,estimationErrors] = estimateCameraParameters(
imagePoints,worldPoints)
```

```
[stereoParams,pairsUsed,estimationErrors] = estimateCameraParameters(
imagePoints,worldPoints)
```

```
cameraParams = estimateCameraParameters( ____,Name,Value)
```

Description

`[cameraParams,imagesUsed,estimationErrors] = estimateCameraParameters(imagePoints,worldPoints)` returns `cameraParams`, a `cameraParameters` object containing estimates for the intrinsic and extrinsic parameters and the distortion coefficients of a single camera. The function also returns the images you used to estimate the camera parameters and the standard estimation errors for the single camera calibration. The `estimateCameraParameters` function estimates extrinsics and intrinsics parameters.

`[stereoParams,pairsUsed,estimationErrors] = estimateCameraParameters(imagePoints,worldPoints)` returns `stereoParams`, a `stereoParameters` object containing the parameters of the stereo camera. The function also returns the images you used to estimate the stereo parameters and the standard estimation errors for the stereo camera calibration.

`cameraParams = estimateCameraParameters(____,Name,Value)` configures the `cameraParams` object properties specified by one or more `Name,Value` pair arguments, using any of the preceding syntaxes. Unspecified properties have their default values.

Examples

Single Camera Calibration

Create a set of calibration images.

```
images = imageSet(fullfile(toolboxdir('vision'),'visiondata',...
    'calibration','mono'));
imageFileNames = images.ImageLocation;
```

Detect the calibration pattern.

```
[imagePoints, boardSize] = detectCheckerboardPoints(imageFileNames);
```

Generate the world coordinates of the corners of the squares.

```
squareSizeInMM = 29;
worldPoints = generateCheckerboardPoints(boardSize,squareSizeInMM);
```

Calibrate the camera.

```
I = readimage(images,1);  
imageSize = [size(I, 1),size(I, 2)];  
params = estimateCameraParameters(imagePoints,worldPoints, ...  
                                'ImageSize',imageSize);
```

Visualize the calibration accuracy.

```
showReprojectionErrors(params);
```

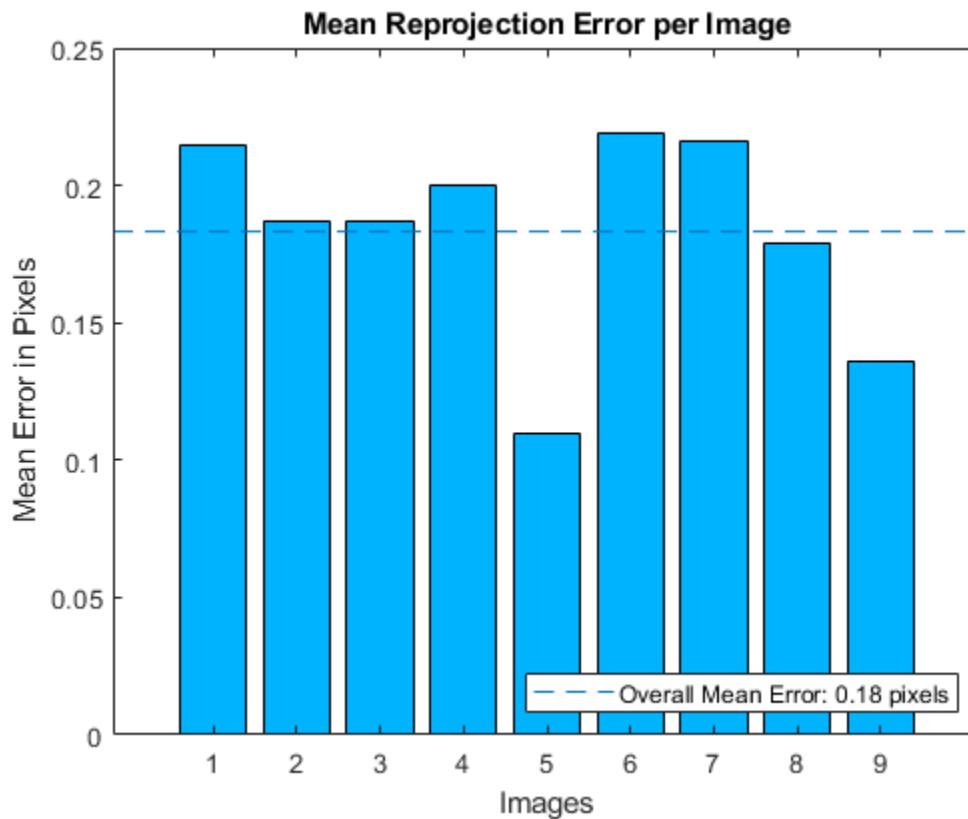

Visualize camera extrinsics.

```
figure;  
showExtrinsics(params);
```

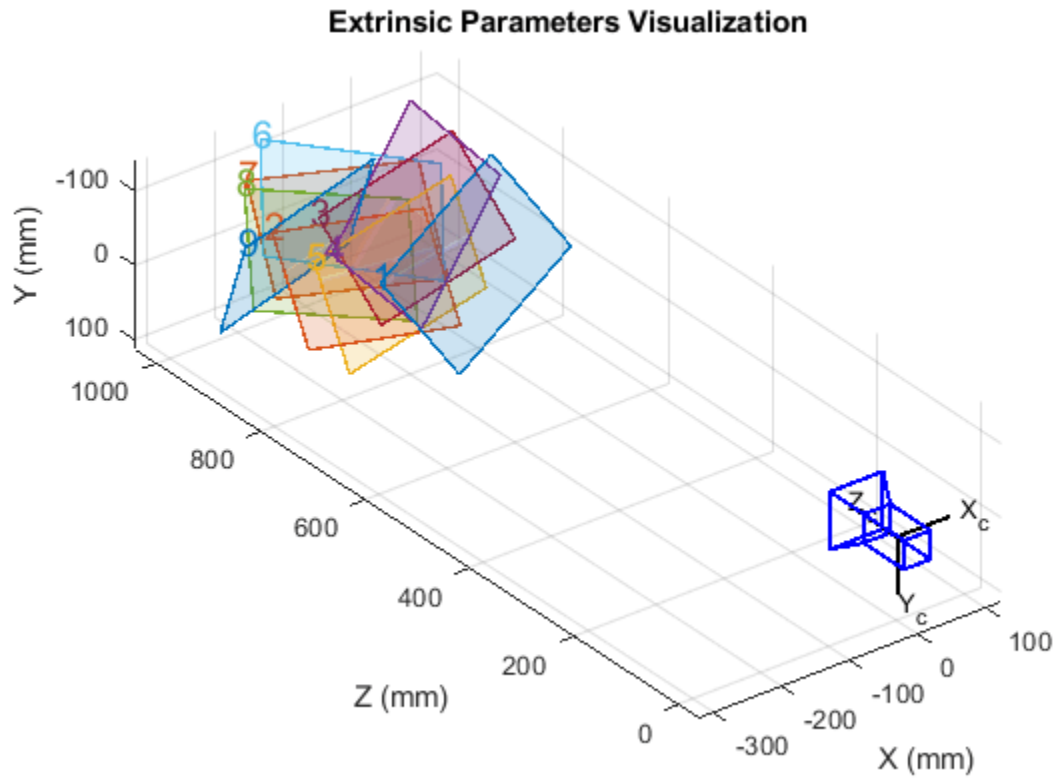
```
drawnow;
```

Plot detected and reprojected points.

```
figure;
imshow(imageFileNames{1});
hold on;
plot(imagePoints(:,1,1), imagePoints(:,2,1), 'go');
plot(params.ReprojectedPoints(:,1,1),params.ReprojectedPoints(:,2,1), 'r+');
legend('Detected Points', 'ReprojectedPoints');
hold off;
```

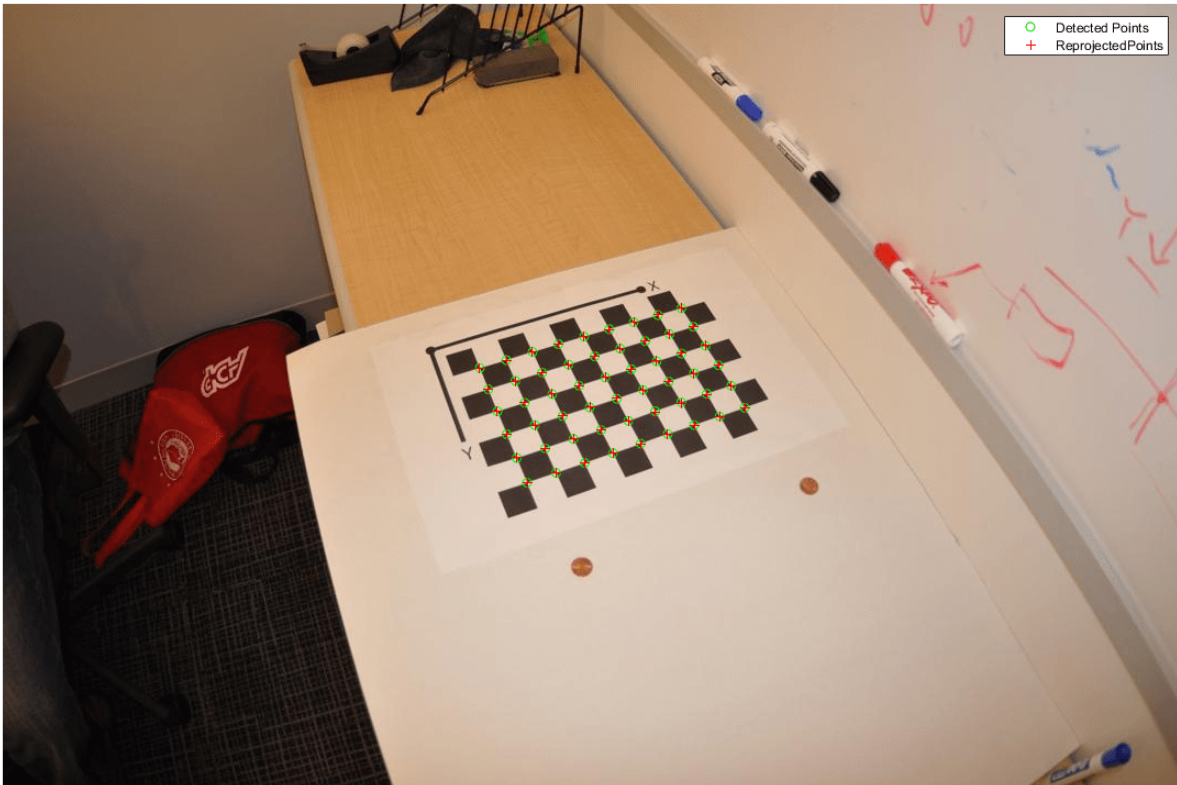

Stereo Camera Calibration

Specify calibration images.

```
leftImages = imageDatastore(fullfile(toolboxdir('vision'),'visiondata', ...
    'calibration','stereo','left'));
rightImages = imageDatastore(fullfile(toolboxdir('vision'),'visiondata', ...
    'calibration','stereo','right'));
```

Detect the checkerboards.

```
[imagePoints,boardSize] = ...
    detectCheckerboardPoints(leftImages.Files,rightImages.Files);
```

Specify the world coordinates of the checkerboard keypoints. Square size is in millimeters.

```
squareSize = 108;
worldPoints = generateCheckerboardPoints(boardSize,squareSize);
```

Calibrate the stereo camera system. Both cameras have the same resolution.

```
I = readimage(leftImages,1);
imageSize = [size(I,1),size(I,2)];
```

```
params = estimateCameraParameters(imagePoints,worldPoints, ...  
                                'ImageSize',imageSize);
```

Visualize the calibration accuracy.

```
showReprojectionErrors(params);
```

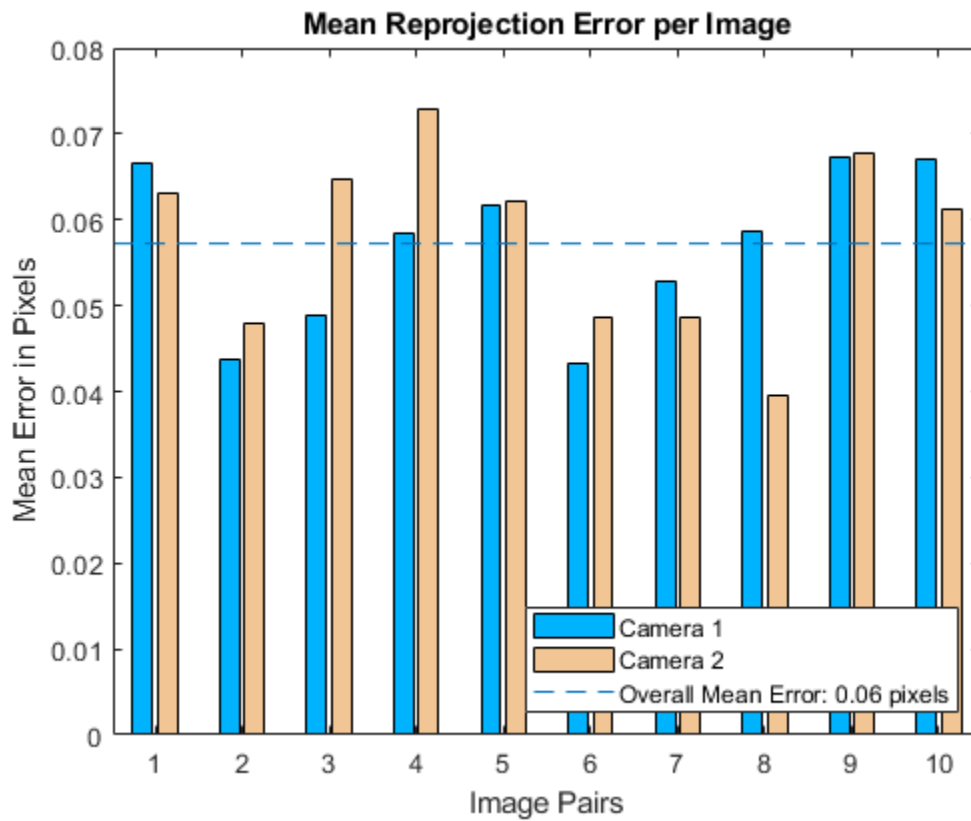

Visualize camera extrinsics.

```
figure;  
showExtrinsics(params);
```

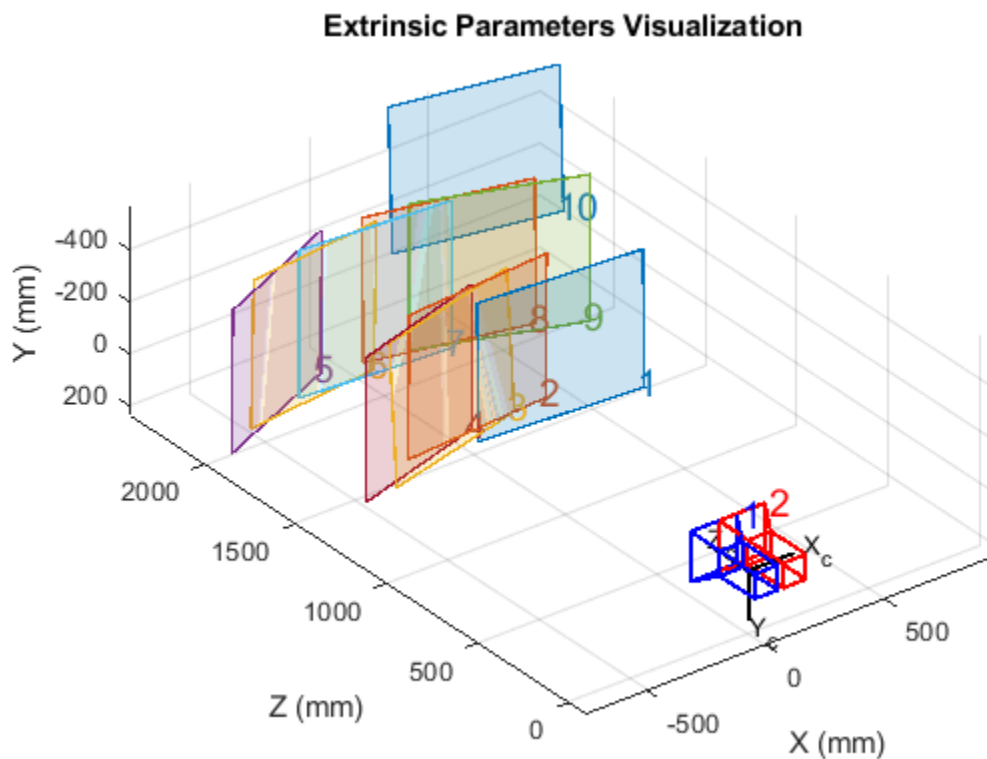

Estimate Camera Parameters Using Circle Grid

Create a set of calibration images.

```
imds = imageDatastore(fullfile(toolboxdir('vision'),'visiondata',...
                              'calibration','circleGrid','mono'));
calibrationImages = readall(imds);
calibrationImages = cat(4,calibrationImages{:});
```

Define the circle grid pattern dimensions.

```
patternDims = [8 11];
```

Detect the pattern in the calibration images.

```
imagePoints = detectCircleGridPoints(calibrationImages, patternDims,...
                                     'PatternType','symmetric');
```

Specify the world coordinates for the circle grid keypoints. Center distance is in millimeters.

```
centerDistance = 18;
worldPoints = generateCircleGridPoints(patternDims,centerDistance,...
                                       'PatternType','symmetric');
```

Calibrate the camera using the calibration images.

```
imageSize = size(calibrationImages,1:2);
params = estimateCameraParameters(imagePoints,worldPoints,...
    'ImageSize',imageSize);
```

Plot the detected pattern grid and the reprojected points.

```
figure
imshow(calibrationImages(:,:,1))
hold on
plot(imagePoints(:,1,1), imagePoints(:,2,1),'gx','MarkerSize',8)
plot(params.ReprojectedPoints(:,1,1),params.ReprojectedPoints(:,2,1),'r+','MarkerSize',8)
legend('Detected Points','ReprojectedPoints')
hold off
```

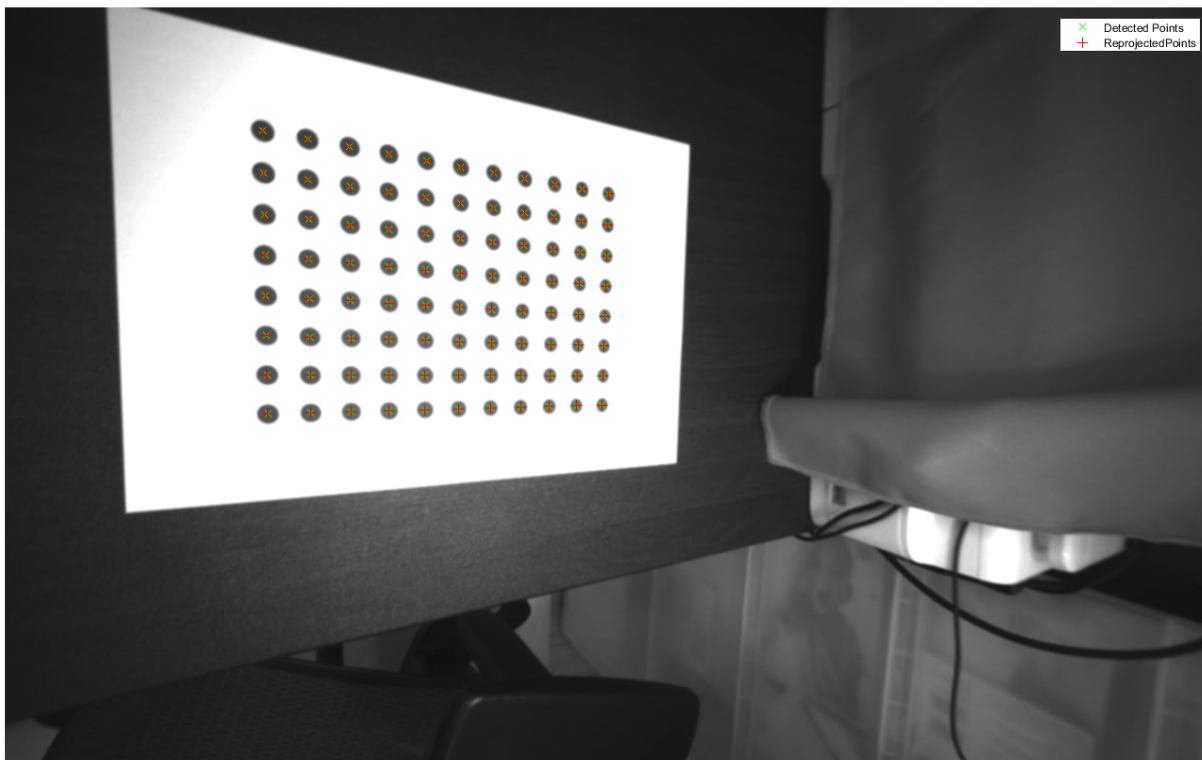

Input Arguments

imagePoints — Key points of calibration pattern

M-by-2-by-*numImages* | *M*-by-2-by-*numPairs*-by-2 array

Key points of calibration pattern, specified as an array of $[x,y]$ intrinsic image coordinates.

Calibration	Input Array of [x,y] Key Points
Single Camera	<p>M-by-2-by-$numImages$ array of [x,y] points.</p> <ul style="list-style-type: none"> The number of images, $numImages$, must be greater than or equal to 2. The number of keypoint coordinates in each pattern, M, must be greater than 3. <p>Partially detected patterns are only supported for single camera calibration. To include partially detected patterns in the estimate, use [NaN, NaN] as x-y coordinates for missing keypoints.</p>
Stereo Camera	<p>M-by-2-by-$numPairs$-by-2 array of [x,y] points.</p> <ul style="list-style-type: none"> $numPairs$ is the number of stereo image pairs containing the calibration pattern. The number of keypoint coordinates in each pattern, M, must be greater than 3. <code>imagePoints(:, :, :, 1)</code> are the points from camera 1. <code>imagePoints(:, :, :, 2)</code> are the points from camera 2.

Data Types: `single` | `double`

worldPoints — Key points of calibration pattern in world coordinates

M -by-2 array

Key points of calibration pattern in world coordinates, specified as an M -by-2 array of M number of [x,y] world coordinates. The pattern must be planar; therefore, z -coordinates are zero.

Data Types: `single` | `double`

Name-Value Pair Arguments

Specify optional comma-separated pairs of `Name`, `Value` arguments. `Name` is the argument name and `Value` is the corresponding value. `Name` must appear inside quotes. You can specify several name and value pair arguments in any order as `Name1, Value1, ..., NameN, ValueN`.

Example: `'WorldUnits', 'mm'` sets the world point units to millimeters.

WorldUnits — World points units

`'mm'` (default) | character vector | string scalar

World points units, specified as the comma-separated pair consisting of `'WorldUnits'` and a character vector or string scalar.

EstimateSkew — Estimate skew

`false` (default) | logical scalar

Estimate skew, specified as the comma-separated pair consisting of `'EstimateSkew'` and a logical scalar. When you set this property to `true`, the function estimates the image axes skew. When set to `false`, the image axes are exactly perpendicular and the function sets the skew to zero.

NumRadialDistortionCoefficients — Number of radial distortion coefficients

2 (default) | 3

Number of radial distortion coefficients to estimate, specified as the comma-separated pair consisting of 'NumRadialDistortionCoefficients' and the value 2 or 3. Radial distortion occurs when light rays bend more near the edges of a lens than they do at its optical center. The smaller the lens, the greater the distortion.

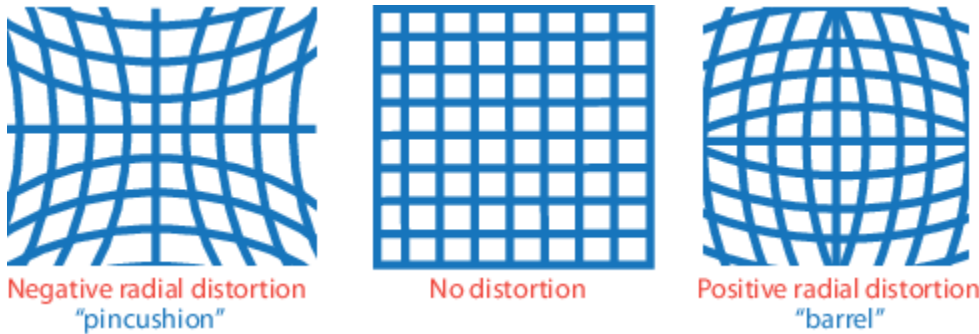

The radial distortion coefficients model this type of distortion. The distorted points are denoted as $(x_{\text{distorted}}, y_{\text{distorted}})$:

$$x_{\text{distorted}} = x(1 + k_1*r^2 + k_2*r^4 + k_3*r^6)$$

$$y_{\text{distorted}} = y(1 + k_1*r^2 + k_2*r^4 + k_3*r^6)$$

- x, y — Undistorted pixel locations. x and y are in normalized image coordinates. Normalized image coordinates are calculated from pixel coordinates by translating to the optical center and dividing by the focal length in pixels. Thus, x and y are dimensionless.
- $k_1, k_2,$ and k_3 — Radial distortion coefficients of the lens.
- $r^2 = x^2 + y^2$

Typically, two coefficients are sufficient for calibration. For severe distortion, such as in wide-angle lenses, you can select three coefficients to include k_3 .

EstimateTangentialDistortion — Tangential distortion flag

`false` (default) | logical scalar

Tangential distortion flag, specified as the comma-separated pair consisting of 'EstimateTangentialDistortion' and a logical scalar. When you set this property to `true`, the function estimates the tangential distortion. When you set it to `false`, the tangential distortion is negligible.

Tangential distortion occurs when the lens and the image plane are not parallel. The tangential distortion coefficients model this type of distortion.

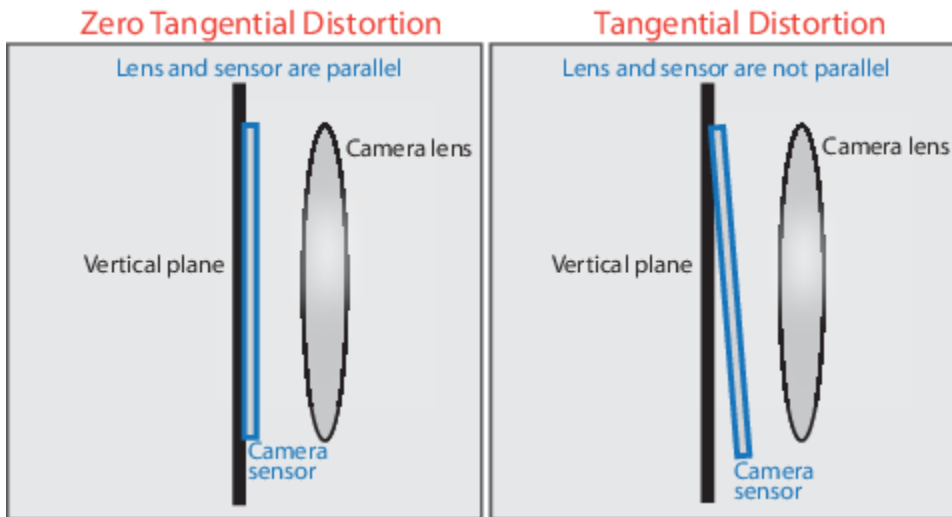

The distorted points are denoted as $(x_{\text{distorted}}, y_{\text{distorted}})$:

$$x_{\text{distorted}} = x + [2 * p_1 * x * y + p_2 * (r^2 + 2 * x^2)]$$

$$y_{\text{distorted}} = y + [p_1 * (r^2 + 2 * y^2) + 2 * p_2 * x * y]$$

- x, y — Undistorted pixel locations. x and y are in normalized image coordinates. Normalized image coordinates are calculated from pixel coordinates by translating to the optical center and dividing by the focal length in pixels. Thus, x and y are dimensionless.
- p_1 and p_2 — Tangential distortion coefficients of the lens.
- $r^2 = x^2 + y^2$

InitialIntrinsicMatrix — Initial guess for camera intrinsics

[] (default) | 3-by-3 matrix

Initial guess for camera intrinsics, specified as the comma-separated pair consisting of 'InitialIntrinsicMatrix' and a 3-by-3 matrix. If you do not provide an initial value, the function computes the initial intrinsic matrix using linear least squares.

InitialRadialDistortion — Initial guess for radial distortion coefficients

[] (default) | 2-element vector | 3-element vector

Initial guess for radial distortion coefficients, specified as the comma-separated pair consisting of 'InitialRadialDistortion' and a 2- or 3-element vector. If you do not provide an initial value, the function uses 0 as the initial value for all the coefficients.

ImageSize — Image size produced by camera

1-by-2 [*mrows*, *ncols*] vector | []

Image size produced by camera, specified as the comma-separated pair consisting of 'ImageSize' and as 1-by-2 [*mrows*, *ncols*] vector.

Output Arguments

cameraParams — Camera parameters

cameraParameters object

Camera parameters, returned as a `cameraParameters` object.

imagesUsed — Images used to estimate camera parameters

P-by-1 logical array

Images you use to estimate camera parameters, returned as a *P*-by-1 logical array. *P* corresponds to the number of images. The array indicates which images you used to estimate the camera parameters. A logical `true` value in the array indicates which images you used to estimate the camera parameters.

The function computes a homography between the world points and the points detected in each image. If the homography computation fails for an image, the function issues a warning. The points for that image are not used for estimating the camera parameters. The function also sets the corresponding element of `imagesUsed` to `false`.

estimationErrors — Standard errors of estimated parameters

`cameraCalibrationErrors` object | `stereoCalibrationErrors` object

Standard errors of estimated parameters, returned as a `cameraCalibrationErrors` object or a `stereoCalibrationErrors` object.

stereoParams — Camera parameters for stereo system

`stereoParameters` object

Camera parameters for stereo system, returned as a `stereoParameters` object. The object contains the intrinsic, extrinsic, and lens distortion parameters of the stereo camera system.

pairsUsed — Image pairs used to estimate camera parameters

P-by-1 logical array

Image pairs used to estimate camera parameters, returned as a *P*-by-1 logical array. *P* corresponds to the number of image pairs. A logical `true` value in the array indicates which image pairs you used to estimate the camera parameters.

Algorithms

Calibration Algorithm

You can use the Camera Calibrator app with cameras up to a field of view (FOV) of 95 degrees.

The calibration algorithm assumes a pinhole camera model:

$$w[x \ y \ 1] = [X \ Y \ Z \ 1] \begin{bmatrix} R \\ t \end{bmatrix} K$$

(*X,Y,Z*): world coordinates of a point

(*x,y*): coordinates of the corresponding image point

w: arbitrary scale factor

K: camera intrinsic matrix

R: matrix representing the 3-D rotation of the camera

t: translation of the camera relative to the world coordinate system

Camera calibration estimates the values of the intrinsic parameters, the extrinsic parameters, and the distortion coefficients. There are two steps involved in camera calibration:

- 1 Solve for the intrinsics and extrinsics in closed form, assuming that lens distortion is zero. [1]
- 2 Estimate all parameters simultaneously including the distortion coefficients using nonlinear least-squares minimization (Levenberg–Marquardt algorithm). Use the closed form solution from the preceding step as the initial estimate of the intrinsics and extrinsics. Then set the initial estimate of the distortion coefficients to zero. [1][2]

References

- [1] Zhang, Z. “A Flexible New Technique for Camera Calibration”. *IEEE Transactions on Pattern Analysis and Machine Intelligence*. Vol. 22, No. 11, 2000, pp. 1330–1334.
- [2] Heikkila, J, and O. Silven. “A Four-step Camera Calibration Procedure with Implicit Image Correction”, *IEEE International Conference on Computer Vision and Pattern Recognition*, 1997.
- [3] Bouguet, J.Y. “Camera Calibration Toolbox for Matlab”, Computational Vision at the California Institute of Technology. Camera Calibration Toolbox for MATLAB
- [4] Bradski, G., and A. Kaehler. *Learning OpenCV : Computer Vision with the OpenCV Library*. Sebastopol, CA: O'Reilly, 2008.

See Also

Apps

[Camera Calibrator](#) | [Stereo Camera Calibrator](#)

Objects

[cameraCalibrationErrors](#) | [stereoCalibrationErrors](#) | [stereoParameters](#) | [cameraParameters](#)

Functions

[showReprojectionErrors](#) | [showExtrinsics](#) | [undistortImage](#) | [undistortPoints](#) | [detectCheckerboardPoints](#) | [generateCheckerboardPoints](#) | [reconstructScene](#) | [rectifyStereoImages](#) | [disparityBM](#) | [disparitySGM](#) | [estimateUncalibratedRectification](#) | [estimateFundamentalMatrix](#) | [estimateStereoBaseline](#)

Topics

[“What Is Camera Calibration?”](#)
[“Using the Single Camera Calibrator App”](#)
[“Coordinate Systems”](#)
[“Evaluating the Accuracy of Single Camera Calibration”](#)

Introduced in R2014b

estimateFundamentalMatrix

Estimate fundamental matrix from corresponding points in stereo images

Syntax

```
estimateFundamentalMatrix
F = estimateFundamentalMatrix(matchedPoints1,matchedPoints2)
[F,inliersIndex] = estimateFundamentalMatrix(matchedPoints1,matchedPoints2)
[F,inliersIndex,status] = estimateFundamentalMatrix(matchedPoints1,
matchedPoints2)
[F,inliersIndex,status] = estimateFundamentalMatrix(matchedPoints1,
matchedPoints2,Name,Value)
```

Description

`estimateFundamentalMatrix` estimates the fundamental matrix from corresponding points in stereo images. This function can be configured to use all corresponding points or to exclude outliers. You can exclude outliers by using a robust estimation technique such as random-sample consensus (RANSAC). When you use robust estimation, results may not be identical between runs because of the randomized nature of the algorithm.

`F = estimateFundamentalMatrix(matchedPoints1,matchedPoints2)` returns the 3-by-3 fundamental matrix, `F`, using the least median of squares (LMedS) method. The input points can be M -by-2 matrices of M number of $[x\ y]$ coordinates, or `KAZEPoints`, `SIFTPoints`, `SURFPoints`, `MSERRegions`, `ORBPoints`, or `cornerPoints` object.

`[F,inliersIndex] = estimateFundamentalMatrix(matchedPoints1,matchedPoints2)` additionally returns logical indices, `inliersIndex`, for the inliers used to compute the fundamental matrix. The `inliersIndex` output is an M -by-1 vector. The function sets the elements of the vector to `true` when the corresponding point was used to compute the fundamental matrix. The elements are set to `false` if they are not used.

`[F,inliersIndex,status] = estimateFundamentalMatrix(matchedPoints1,matchedPoints2)` additionally returns a status code.

`[F,inliersIndex,status] = estimateFundamentalMatrix(matchedPoints1,matchedPoints2,Name,Value)` uses additional options specified by one or more `Name,Value` pair arguments.

Examples

Compute Fundamental Matrix

The RANSAC method requires that the input points are already putatively matched. We can, for example, use the `matchFeatures` function for this. Using the RANSAC algorithm eliminates any outliers which may still be contained within putatively matched points.

Load stereo points.

```
load stereoPointPairs
```

Estimate the fundamental matrix.

```
fRANSAC = estimateFundamentalMatrix(matchedPoints1,...
    matchedPoints2,'Method','RANSAC',...
    'NumTrials',2000,'DistanceThreshold',1e-4)
```

```
fRANSAC = 3×3
```

```
    0.0000    -0.0004    0.0348
    0.0004     0.0000   -0.0937
   -0.0426     0.0993    0.9892
```

Use the Least Median of Squares Method to Find Inliers

Load the putatively matched points.

```
load stereoPointPairs
[fLMedS, inliers] = estimateFundamentalMatrix(matchedPoints1,matchedPoints2,'NumTrials',2000)
```

```
fLMedS = 3×3
```

```
    0.0000    -0.0004    0.0349
    0.0004     0.0000   -0.0938
   -0.0426     0.0994    0.9892
```

```
inliers = 18x1 logical array
```

```

1
1
1
1
1
1
1
0
1
0
0
0
⋮
```

Load the stereo images.

```
I1 = imread('viprectification_deskLeft.png');
I2 = imread('viprectification_deskRight.png');
```

Show the putatively matched points.

```
figure;
showMatchedFeatures(I1,I2,matchedPoints1,matchedPoints2,'montage','PlotOptions',{'ro','go','y--'});
title('Putative point matches');
```

Putative point matches

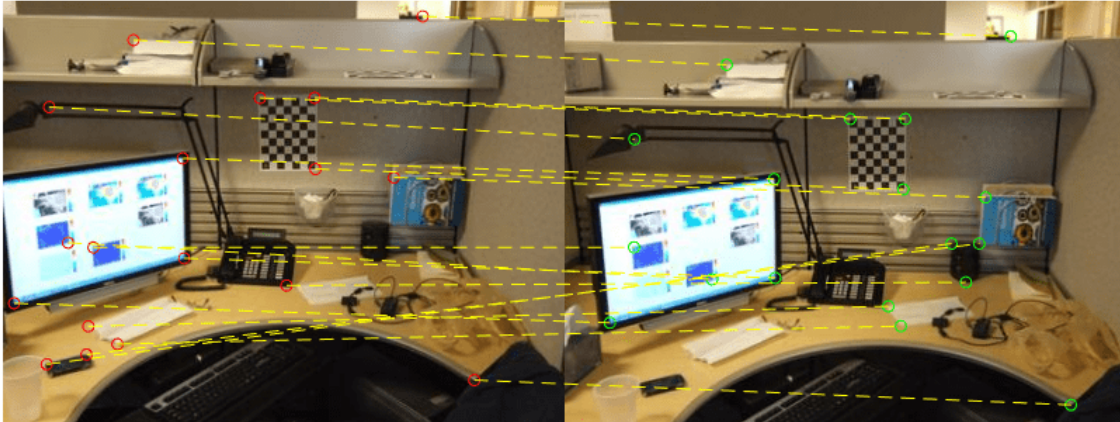

Show the inlier points.

```
figure;
showMatchedFeatures(I1, I2, matchedPoints1(inliers,:), matchedPoints2(inliers,:), 'montage', 'Plot0');
title('Point matches after outliers were removed');
```

Point matches after outliers were removed

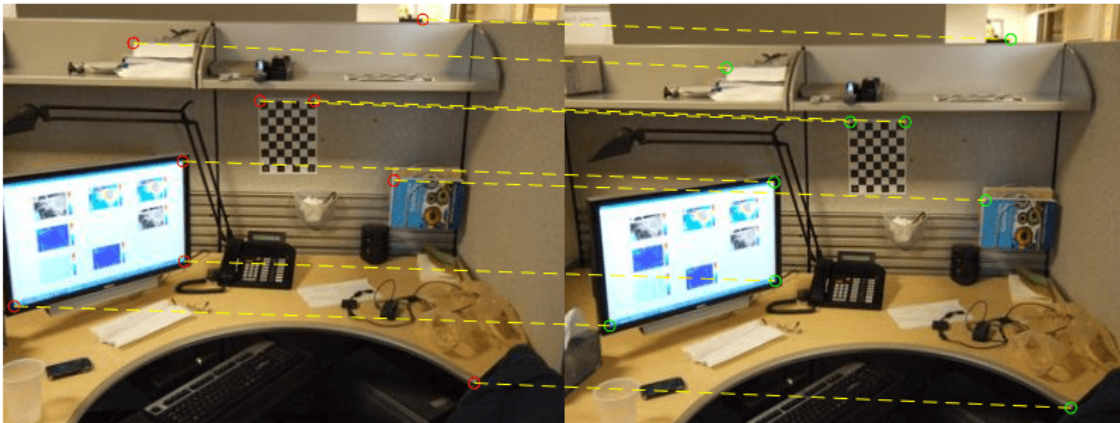

Use the Normalized Eight-Point Algorithm to Compute the Fundamental Matrix

Load the stereo point pairs.

```
load stereoPointPairs
```

Compute the fundamental matrix for input points which do not contain any outliers.

```
inlierPts1 = matchedPoints1(knownInliers,:);
inlierPts2 = matchedPoints2(knownInliers,:);
fNorm8Point = estimateFundamentalMatrix(inlierPts1,inlierPts2,'Method','Norm8Point')
```

```
fNorm8Point = 3×3

    0.0000    -0.0004    0.0348
    0.0004     0.0000   -0.0937
   -0.0426     0.0993    0.9892
```

Input Arguments

matchedPoints1 — Coordinates of corresponding points

SIFTPoints | SURFPoints | cornerPoints | MSERRegions | ORBPoints object | *M*-by-2 matrix of [x,y] coordinates

Coordinates of corresponding points in image one, specified as an *M*-by-2 matrix of *M* number of [x y] coordinates, or as a KAZEPoints, SIFTPoints, SURFPoints, MSERRegions, ORBPoints, or cornerPoints object. The matchedPoints1 input must contain points which do not lie on a single planar surface, (e.g., a wall, table, or book) and are putatively matched by using a function such as matchFeatures.

matchedPoints2 — Coordinates of corresponding points

SIFTPoints | SURFPoints | cornerPoints | MSERRegions | ORBPoints object | *M*-by-2 matrix of [x,y] coordinates

Coordinates of corresponding points in image two, specified as an *M*-by-2 matrix of *M* number of [x y] coordinates, or as a KAZEPoints, SIFTPoints, SURFPoints, MSERRegions, ORBPoints, or cornerPoints object. The matchedPoints1 input must contain points which do not lie on a single planar surface, (e.g., a wall, table, or book) and are putatively matched by using a function such as matchFeatures.

Name-Value Pair Arguments

Specify optional comma-separated pairs of Name, Value arguments. Name is the argument name and Value is the corresponding value. Name must appear inside quotes. You can specify several name and value pair arguments in any order as Name1, Value1, ..., NameN, ValueN.

Example: 'Method', 'RANSAC' specifies RANSAC as the method to compute the fundamental matrix.

Method — Method used to compute the fundamental matrix

LMedS (default) | Norm8Point | RANSAC | MSAC | LTS

Method used to compute the fundamental matrix, specified as the comma-separated pair consisting of 'Method' and one of the following:

Norm8Point Normalized eight-point algorithm. To produce reliable results, the inputs, matchedPoints1 and matchedPoints2 must match precisely.

LMedS Least Median of Squares. Select this method if you know that at least 50% of the points in matchedPoints1 and matchedPoints2 are inliers.

RANSAC RANdom SAMple Consensus. Select this method if you would like to set the distance threshold for the inliers.

MSAC M-estimator SAmple Consensus. Select the M-estimator SAmple Consensus method if you would like to set the distance threshold for the inliers. Generally, the MSAC method converges more quickly than the RANSAC method.

LTS Least Trimmed Squares. Select the Least Trimmed Squares method if you know a minimum percentage of inliers in `matchedPoints1` and `matchedPoints2`. Generally, the LTS method converges more quickly than the LMedS method.

To produce reliable results using the `Norm8Point` algorithm, the inputs, `matchedPoints1` and `matchedPoints2`, must match precisely. The other methods can tolerate outliers and therefore only require putatively matched input points. You can obtain putatively matched points by using the `matchFeatures` function.

OutputClass – Fundamental matrix class

'double' (default) | 'single'

Fundamental matrix class, specified as the comma-separated pair consisting of 'OutputClass' and either 'double' or 'single'. This specifies the class for the fundamental matrix and the function's internal computations.

NumTrials – Number of random trials for finding the outliers

500 (default) | integer

Number of random trials for finding the outliers, specified as the comma-separated pair consisting of 'NumTrials' and an integer value. This parameter applies when you set the `Method` parameter to LMedS, RANSAC, MSAC, or LTS.

When you set the `Method` parameter to either LMedS or LTS, the function uses the actual number of trials as the parameter value.

When you set the `Method` parameter to either RANSAC or MSAC, the function uses the maximum number of trials as the parameter value. The actual number of trials depends on `matchedPoints1`, `matchedPoints2`, and the value of the `Confidence` parameter.

Select the number of random trials to optimize speed and accuracy.

DistanceType – Algebraic or Sampson distance type

'Sampson' (default) | 'Algebraic'

Algebraic or Sampson distance type, specified as the comma-separated pair consisting of 'DistanceType' and either the Algebraic or Sampson. The distance type determines whether a pair of points is an inlier or outlier. This parameter applies when you set the `Method` parameter to LMedS, RANSAC, MSAC, or LTS.

Note For faster computations, set this parameter to `Algebraic`. For a geometric distance, set this parameter to `Sampson`.

Data Types: char

DistanceThreshold – Distance threshold for finding outliers

0.01 (default)

Distance threshold for finding outliers, specified as the comma-separated pair consisting of 'DistanceThreshold' and a positive value. This parameter applies when you set the Method parameter to RANSAC or MSAC.

Confidence — Desired confidence for finding maximum number of inliers

99 (default) | scalar

Desired confidence for finding maximum number of inliers, specified as the comma-separated pair consisting of 'Confidence' and a percentage scalar value in the range (0 100). This parameter applies when you set the Method parameter to RANSAC or MSAC.

InlierPercentage — Minimum percentage of inliers in input points

50 (default) | scalar

Minimum percentage of inliers in input points, specified as the comma-separated pair consisting of 'InlierPercentage' and percentage scalar value in the range (0 100). Specify the minimum percentage of inliers in `matchedPoints1` and `matchedPoints2`. This parameter applies when you set the Method parameter to LTS.

ReportRuntimeError — Report runtime error

true (default) | false

Report runtime error, specified as the comma-separated pair consisting of 'ReportRuntimeError' and a logical value. Set this parameter to true to report run-time errors when the function cannot compute the fundamental matrix from `matchedPoints1` and `matchedPoints2`. When you set this parameter to false, you can check the status output to verify validity of the fundamental matrix.

Output Arguments

F — Fundamental matrix

3-by-3 matrix

Fundamental matrix, returns as a 3-by-3 matrix that is computed from the points in the inputs `matchedPoints1` and `matchedPoints2`.

$$[P_2 \ 1] * \text{FundamentalMatrix} * [P_1 \ 1]' = 0$$

P_1 , the point in `matchedPoints1` of image 1 in pixels, corresponds to the point, P_2 , the point in `matchedPoints2` in image 2.

In computer vision, the fundamental matrix is a 3-by-3 matrix which relates corresponding points in stereo images. When two cameras view a 3-D scene from two distinct positions, there are a number of geometric relations between the 3-D points and their projections onto the 2-D images that lead to constraints between the image points. Two images of the same scene are related by epipolar geometry.

inliersIndex — Inliers index

M-by-1 logical vector

Inliers index, returned as an M-by-1 logical index vector. An element set to true means that the corresponding indexed matched points in `matchedPoints1` and `matchedPoints2` were used to compute the fundamental matrix. An element set to false means the indexed points were not used for the computation.

Data Types: logical

status — Status code

0 | 1 | 2

Status code, returned as one of the following possible values:

status	Value
0:	No error.
1:	matchedPoints1 and matchedPoints2 do not contain enough points. Norm8Point, RANSAC, and MSAC require at least 8 points, LMedS 16 points, and LTS requires $\text{ceil}(800/\text{InlierPercentage})$.
2:	Not enough inliers found.

Data Types: int32

Tips

Use `estimateEssentialMatrix` when you know the camera intrinsics. You can obtain the intrinsics using the **Camera Calibrator** app. Otherwise, you can use the `estimateFundamentalMatrix` function that does not require camera intrinsics. Note that the fundamental matrix cannot be estimated from coplanar world points.

Algorithms**Computing the Fundamental Matrix**

This function computes the fundamental matrix using the normalized eight-point algorithm [1]

When you choose the `Norm8Point` method, the function uses all points in `matchedPoints1` and `matchedPoints2` to compute the fundamental matrix.

When you choose any other method, the function uses the following algorithm to exclude outliers and compute the fundamental matrix from inliers:

- 1 Initialize the fundamental matrix, F , to a 3-by-3 matrix of zeros.
- 2 Set the loop counter n , to zero, and the number of loops N , to the number of random trials specified.
- 3 Loop through the following steps while $n < N$:
 - a Randomly select 8 pairs of points from `matchedPoints1` and `matchedPoints2`.
 - b Use the selected 8 points to compute a fundamental matrix, f , by using the normalized 8-point algorithm.
 - c Compute the fitness of f for all points in `matchedPoints1` and `matchedPoints2`.
 - d If the fitness of f is better than F , replace F with f .

For RANSAC and MSAC, update N .
 - e $n = n + 1$

Number of Random Samplings for RANSAC and MSAC Methods

The RANSAC and MSAC methods update the number of random trials N , for every iteration in the algorithm loop. The function resets N , according to the following:

$$N = \min\left(N, \frac{\log(1-p)}{\log(1-r^8)}\right).$$

Where, p represents the confidence parameter you specified, and r is calculated as follows:

$$\sum_i^N \text{sgn}(d(u_i, v_i), t)/N, \text{ where } \text{sgn}(a, b) = 1 \text{ if } a \leq b \text{ and } 0 \text{ otherwise.}$$

When you use RANSAC or MSAC, results may not be identical between runs because of the randomized nature of the algorithm.

Distance Types

The function provides two distance types, algebraic distance and Sampson distance, to measure the distance of a pair of points according to a fundamental matrix. The following equations are used for each type, with u representing `matchedPoints1` and v representing `matchedPoints2`.

Algebraic distance:
$$d(u_i, v_i) = (v_i F u_i^T)^2$$

Sampson distance:
$$d(u_i, v_i) = (v_i F u_i^T)^2 \left[\frac{1}{(F u_i^T)_1^2 + (F u_i^T)_2^2} + \frac{1}{(v_i F)_1^2 + (v_i F)_2^2} \right]$$

where i represents the index of the corresponding points, and $(F u_i^T)_j^2$, the square of the j -th entry of the vector $F u_i^T$.

Fitness of Fundamental Matrix for Corresponding Points

The following table summarizes how each method determines the fitness of the computed fundamental matrix:

Method	Measure of Fitness
LMedS	$\text{median}(d(u_i, v_i); i = 1:N)$, the number of input points. The smaller the value, the better the fitness.
RANSAC	$\sum_i^N \text{sgn}(d(u_i, v_i), t)/N$, where $\text{sgn}(a, b) = 1$ if $a \leq b$ and 0 otherwise, t represents the specified threshold. The greater the value, the better the fitness.
MSAC	$\sum_i^N \min(d(u_i, v_i), t)$. The smaller the value, the better the fitness.
LTS	$\sum_{i \in \Omega} d(u_i, v_i)$, where Ω is the first lowest value of an $(N \times q)$ pair of points. Where q represents the inlier percentage you specified. The smaller the value, the better the fitness.

References

- [1] Hartley, R., A. Zisserman, *Multiple View Geometry in Computer Vision*, Cambridge University Press, 2003.
- [2] Rousseeuw, P., A. Leroy, *Robust Regression and Outlier Detection*, John Wiley & Sons, 1987.
- [3] Torr, P. H. S., and A. Zisserman, *MLESAC: A New Robust Estimator with Application to Estimating Image Geometry*, *Computer Vision and Image Understanding*, 2000.

Extended Capabilities

C/C++ Code Generation

Generate C and C++ code using MATLAB® Coder™.

Usage notes and limitations:

- 'Method', 'OutputClass', 'DistanceType', and 'ReportRuntimeError' must be compile-time constants.

See Also

Functions

epipolarLine | extractFeatures | matchFeatures | estimateUncalibratedRectification | detectSURFFeatures | detectHarrisFeatures | detectMSERFeatures | detectMinEigenFeatures | detectORBFeatures | detectFASTFeatures | relativeCameraPose

Topics

“Structure From Motion From Two Views”

“Structure From Motion From Multiple Views”

“Point Feature Types”

“Structure from Motion Overview”

“Coordinate Systems”

Introduced in R2012b

estimateEssentialMatrix

Estimate essential matrix from corresponding points in a pair of images

Syntax

```
E = estimateEssentialMatrix(matchedPoints1,matchedPoints2,cameraParams)
E = estimateEssentialMatrix(matchedPoints1,matchedPoints2,cameraParams1,
cameraParams2)
```

```
[E,inliersIndex] = estimateEssentialMatrix( ___ )
[E,inliersIndex,status] = estimateEssentialMatrix( ___ )
```

```
[ ___ ] = estimateEssentialMatrix( ___ ,Name,Value)
```

Description

`E = estimateEssentialMatrix(matchedPoints1,matchedPoints2,cameraParams)` returns the 3-by-3 essential matrix, `E`, using the M-estimator sample consensus (MSAC) algorithm. The input points can be M -by-2 matrices of M number of $[x,y]$ coordinates, or a `KAZEPoints`, `SIFTPoints`, `SURFPoints`, `MSERRegions`, `BRISKPoints`, or `cornerPoints` object. The `cameraParams` object contains the parameters of the camera used to take the images.

`E = estimateEssentialMatrix(matchedPoints1,matchedPoints2,cameraParams1,cameraParams2)` returns the essential matrix relating two images taken by different cameras. `cameraParams1` and `cameraParams2` are `cameraParameters` objects containing the parameters of camera 1 and camera 2 respectively.

`[E,inliersIndex] = estimateEssentialMatrix(___)` additionally returns an M -by-1 logical vector, `inliersIndex`, used to compute the essential matrix. The function sets the elements of the vector to `true` when the corresponding point was used to compute the fundamental matrix. The elements are set to `false` if they are not used.

`[E,inliersIndex,status] = estimateEssentialMatrix(___)` additionally returns a status code to indicate the validity of points.

`[___] = estimateEssentialMatrix(___ ,Name,Value)` uses additional options specified by one or more `Name,Value` pair arguments.

Examples

Estimate Essential Matrix from Pair of Images

Load precomputed camera parameters.

```
load upToScaleReconstructionCameraParameters.mat
```

Read and undistort two images.

```
imageDir = fullfile(toolboxdir('vision'),'visiondata',...
    'upToScaleReconstructionImages');
```

```

images = imageDatastore(imageDir);
I1 = undistortImage(readimage(images,1),cameraParams);
I2 = undistortImage(readimage(images,2),cameraParams);
I1gray = im2gray(I1);
I2gray = im2gray(I2);

```

Detect feature points each image.

```

imagePoints1 = detectSURFFeatures(I1gray);
imagePoints2 = detectSURFFeatures(I2gray);

```

Extract feature descriptors from each image.

```

features1 = extractFeatures(I1gray,imagePoints1,'Upright',true);
features2 = extractFeatures(I2gray,imagePoints2,'Upright',true);

```

Match features across the images.

```

indexPairs = matchFeatures(features1,features2);
matchedPoints1 = imagePoints1(indexPairs(:,1));
matchedPoints2 = imagePoints2(indexPairs(:,2));
figure
showMatchedFeatures(I1,I2,matchedPoints1,matchedPoints2);
title('Putative Matches')

```

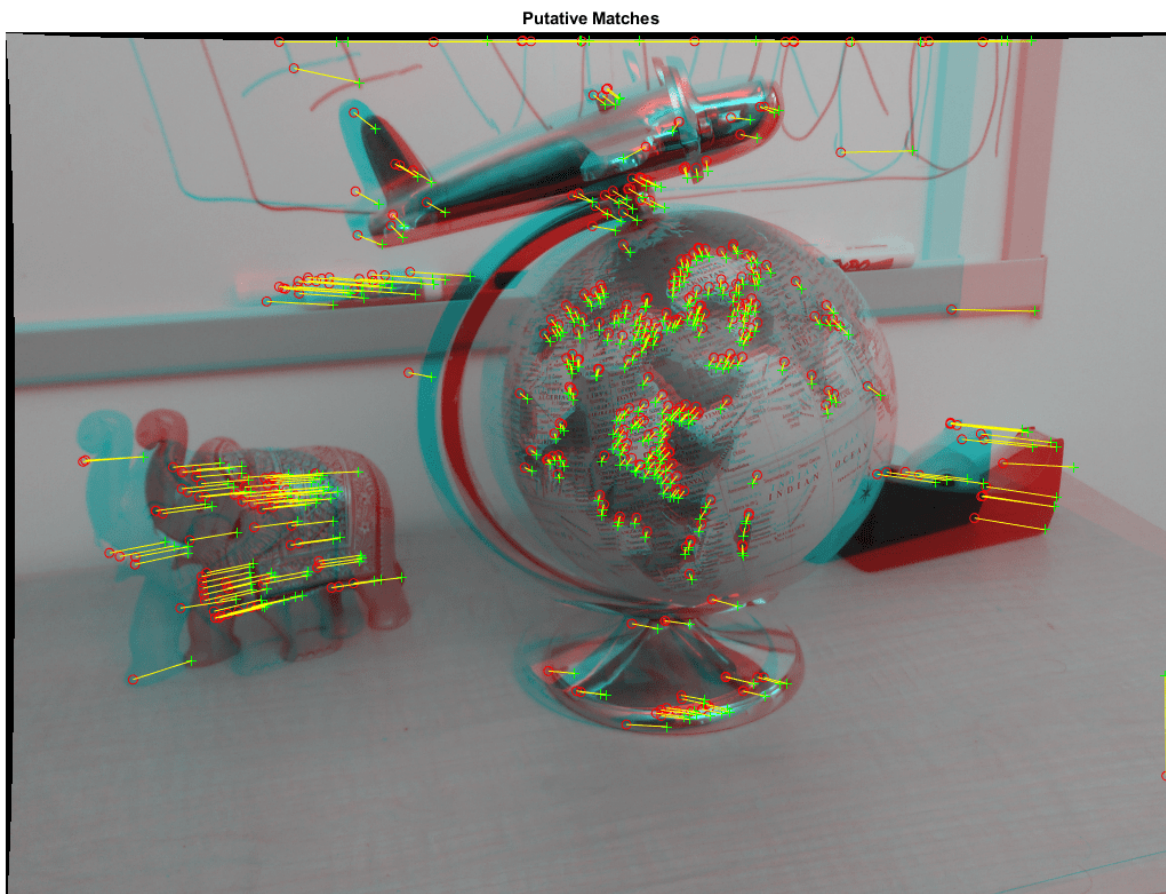

Estimate the essential matrix.

```
[E,inliers] = estimateEssentialMatrix(matchedPoints1,matchedPoints2,...
    cameraParams);
```

Display the inlier matches.

```
inlierPoints1 = matchedPoints1(inliers);
inlierPoints2 = matchedPoints2(inliers);
figure
showMatchedFeatures(I1,I2,inlierPoints1,inlierPoints2);
title('Inlier Matches')
```

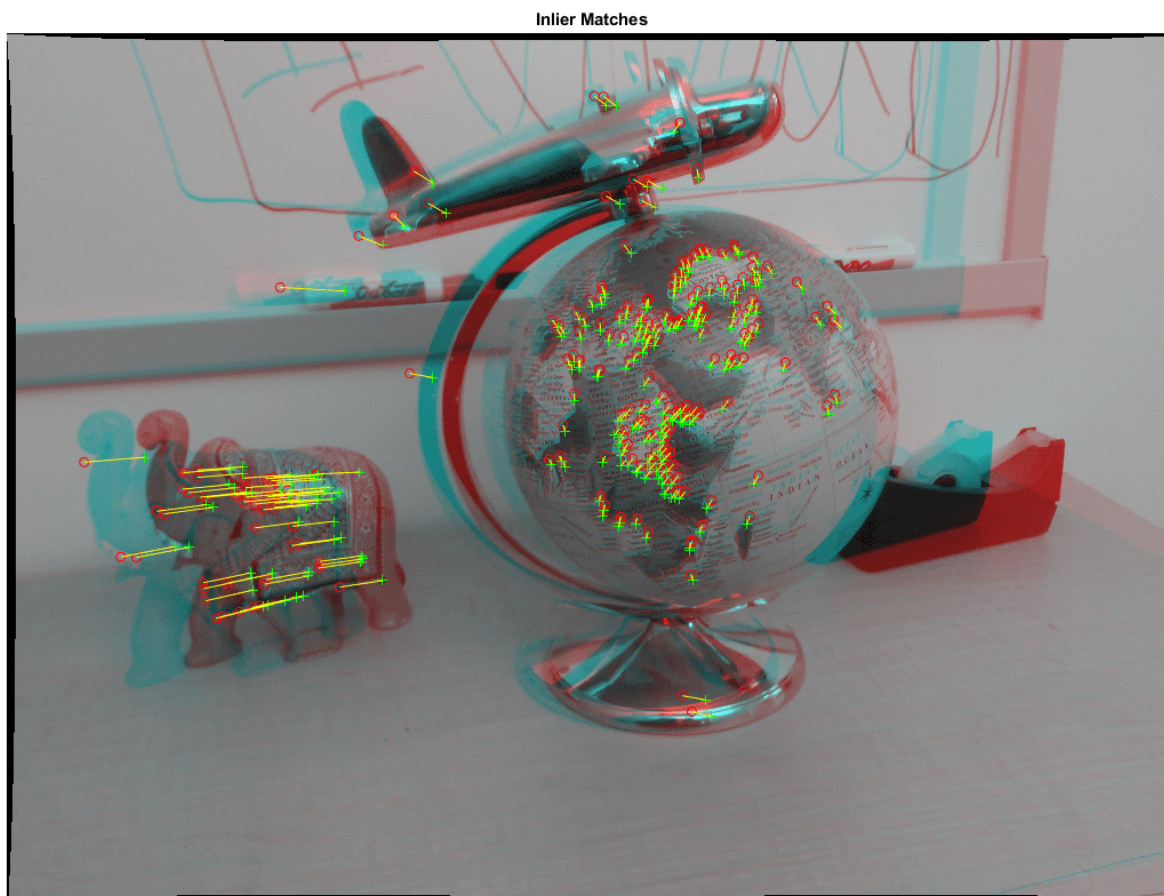

Input Arguments

matchedPoints1 — Coordinates of corresponding points

M-by-2 matrix of $[x,y]$ coordinates | KAZEPoints | SIFTPoints | SURFPoints | BRISKPoints | MSERRegions | cornerPoints

Coordinates of corresponding points in image 1, specified as an *M*-by-2 matrix of *M* of $[x,y]$ coordinates, or as a KAZEPoints, SIFTPoints, SURFPoints, BRISKPoints, MSERRegions, or

cornerPoints object. The matchedPoints1 input must contain at least five points, which are putatively matched by using a function such as matchFeatures.

matchedPoints2 — Coordinates of corresponding points

SIFTPoints | SURFPoints | cornerPoints | MSERRegions | BRISKPoints | M -by-2 matrix of $[x,y]$ coordinates

Coordinates of corresponding points in image 1, specified as an M -by-2 matrix of M of $[x,y]$ coordinates, or as a KAZEPoints, SIFTPoints, SURFPoints, MSERRegions, BRISKPoints, or cornerPoints object. The matchedPoints2 input must contain at least five points, which are putatively matched by using a function such as matchFeatures.

cameraParams — Object for storing camera parameters

cameraParameters object | cameraIntrinsics object

Camera parameters, specified as a cameraParameters or cameraIntrinsics object. You can return the cameraParameters object using the estimateCameraParameters function. The cameraParameters object contains the intrinsic, extrinsic, and lens distortion parameters of a camera.

cameraParams1 — Camera parameters for camera 1

cameraParameters object | cameraIntrinsics object

Camera parameters for camera 1, specified as a cameraParameters or cameraIntrinsics object. You can return the cameraParameters object using the estimateCameraParameters function. The cameraParameters object contains the intrinsic, extrinsic, and lens distortion parameters of a camera.

cameraParams2 — Camera parameters for camera 2

cameraParameters object | cameraIntrinsics object

Camera parameters for camera 2, specified as a cameraParameters or cameraIntrinsics object. You can return the cameraParameters object using the estimateCameraParameters function. The cameraParameters object contains the intrinsic, extrinsic, and lens distortion parameters of a camera.

Name-Value Pair Arguments

Specify optional comma-separated pairs of Name, Value arguments. Name is the argument name and Value is the corresponding value. Name must appear inside quotes. You can specify several name and value pair arguments in any order as Name1, Value1, ..., NameN, ValueN.

Example: 'MaxNumTrials', 500

MaxNumTrials — Maximum number of random trials for finding the outliers

500 (default) | positive integer

Maximum number of random trials for finding outliers, specified as the comma-separated pair consisting of 'MaxNumTrials' and a positive integer. The actual number of trials depends on matchedPoints1, matchedPoints2, and the value of the Confidence parameter. To optimize speed and accuracy, select the number of random trials.

Confidence — Desired confidence for finding maximum number of inliers

99 (default) | scalar

Desired confidence for finding the maximum number of inliers, specified as the comma-separated pair consisting of 'Confidence' and a percentage scalar value in the range (0,100). Increasing this value improves the robustness of the output but increases the amount of computations.

MaxDistance — Sampson distance threshold

0.1 (default) | scalar

Sampson distance threshold, specified as the comma-separated pair consisting of 'MaxDistance' and a scalar value. The function uses the threshold to find outliers returned in pixels squared. The Sampson distance is a first-order approximation of the squared geometric distance between a point and the epipolar line. Increase this value to make the algorithm converge faster, but this can also adversely affect the accuracy of the result.

Output Arguments

E — Essential matrix

3-by-3 matrix

Essential matrix, returned as a 3-by-3 matrix that is computed from the points in the `matchedPoints1` and `matchedPoints2` inputs with known camera intrinsics.

$$[P_2 \ 1] * \text{EssentialMatrix} * [P_1 \ 1]^T = 0$$

The P_1 point in image 1, in normalized image coordinates, corresponds to the P_2 point in image 2.

In computer vision, the essential matrix is a 3-by-3 matrix which relates corresponding points in stereo images which are in normalized image coordinates. When two cameras view a 3-D scene from two distinct positions, the geometric relations between the 3-D points and their projections onto the 2-D images lead to constraints between image points. The two images of the same scene are related by epipolar geometry.

Data Types: double

inliersIndex — Inliers index

M-by-1 logical vector

Inliers index, returned as an M-by-1 logical index vector. An element set to `true` indicates that the corresponding indexed matched points in `matchedPoints1` and `matchedPoints2` were used to compute the essential matrix. An element set to `false` means the indexed points were not used for the computation.

Data Types: logical

status — Status code

0 | 1 | 2

Status code, returned as one of the following possible values:

status	Value
0:	No error.
1:	<code>matchedPoints1</code> and <code>matchedPoints2</code> do not contain enough points. At least five points are required.
2:	Not enough inliers found. A least five inliers are required.

Data Types: int32

Tips

Use `estimateEssentialMatrix` when you know the camera intrinsics. You can obtain the intrinsics using the **Camera Calibrator** app. Otherwise, you can use the `estimateFundamentalMatrix` function that does not require camera intrinsics. The fundamental matrix cannot be estimated from coplanar world points.

References

- [1] Kukulova, Z., M. Bujnak, and T. Pajdla *Polynomial Eigenvalue Solutions to the 5-pt and 6-pt Relative Pose Problems*. Leeds, UK: BMVC, 2008.
- [2] Nister, D.. "An Efficient Solution to the Five-Point Relative Pose Problem." *IEEE Transactions on Pattern Analysis and Machine Intelligence*. Volume 26, Issue 6, June 2004.
- [3] Torr, P. H. S., and A. Zisserman. "MLE-SAC: A New Robust Estimator with Application to Estimating Image Geometry." *Computer Vision and Image Understanding*. Volume 78, Issue 1, April 2000, pp. 138-156.

Extended Capabilities

C/C++ Code Generation

Generate C and C++ code using MATLAB® Coder™.

Usage notes and limitations:

- Use in a MATLAB Function block is not supported.

See Also

Apps

Camera Calibrator

Functions

`estimateFundamentalMatrix` | `relativeCameraPose` | `estimateCameraParameters` | `estimateWorldCameraPose`

Topics

"Structure From Motion From Two Views"
"Structure From Motion From Multiple Views"
"Point Feature Types"
"Structure from Motion Overview"
"Coordinate Systems"

Introduced in R2016b

estimateStereoBaseline

Estimate baseline of stereo camera

Syntax

```
[stereoParams,pairsUsed,estimationErrors] = estimateStereoBaseline(
imagePoints,worldPoints,intrinsics1,intrinsics2)
[stereoParams,pairsUsed,estimationErrors] = estimateStereoBaseline(
imagePoints,worldPoints,intrinsics1,intrinsics2,'WorldUnits',units)
```

Description

`[stereoParams,pairsUsed,estimationErrors] = estimateStereoBaseline(imagePoints,worldPoints,intrinsics1,intrinsics2)` estimates the translation and orientation between two cameras of the same resolution.

The `estimateStereoBaseline` function is best used for a stereo system with a wide baseline when the cameras are so far apart that you cannot capture the complete calibration pattern in the field-of-view of each camera. This function estimates extrinsic parameters using fixed camera intrinsics that have been estimated independently for each camera. Calibrating each camera independently results in more precise estimates of the intrinsics.

`[stereoParams,pairsUsed,estimationErrors] = estimateStereoBaseline(imagePoints,worldPoints,intrinsics1,intrinsics2,'WorldUnits',units)` specifies the units in which `worldPoints` are measured.

Examples

Estimate Baseline of a Stereo System

Load camera intrinsic parameters.

```
ld = load('wideBaselineStereo');
```

Specify stereo calibration images.

```
leftImages = imageDatastore(fullfile(toolboxdir('vision'),'visiondata', ...
    'calibration','wideBaseline','left'));
rightImages = imageDatastore(fullfile(toolboxdir('vision'),'visiondata', ...
    'calibration','wideBaseline','right'));
```

Detect the checkerboards.

```
[imagePoints, boardSize] = ...
    detectCheckerboardPoints(leftImages.Files,rightImages.Files);
```

Specify world coordinates of checkerboard keypoints.

```
squareSize = 29; % in millimeters
worldPoints = generateCheckerboardPoints(boardSize,squareSize);
```

Estimate the baseline and extrinsic parameters.

```
params = estimateStereoBaseline(imagePoints,worldPoints, ...
    ld.intrinsics1,ld.intrinsics2)
```

```
params =
  stereoParameters with properties:

    Parameters of Two Cameras
      CameraParameters1: [1x1 cameraParameters]
      CameraParameters2: [1x1 cameraParameters]

    Inter-camera Geometry
      RotationOfCamera2: [3x3 double]
      TranslationOfCamera2: [-965.4305 70.7497 488.3447]
      FundamentalMatrix: [3x3 double]
      EssentialMatrix: [3x3 double]

    Accuracy of Estimation
      MeanReprojectionError: 0.2586

    Calibration Settings
      NumPatterns: 6
      WorldPoints: [54x2 double]
      WorldUnits: 'mm'
```

Visualize calibration accuracy.

```
figure
showReprojectionErrors(params)
```

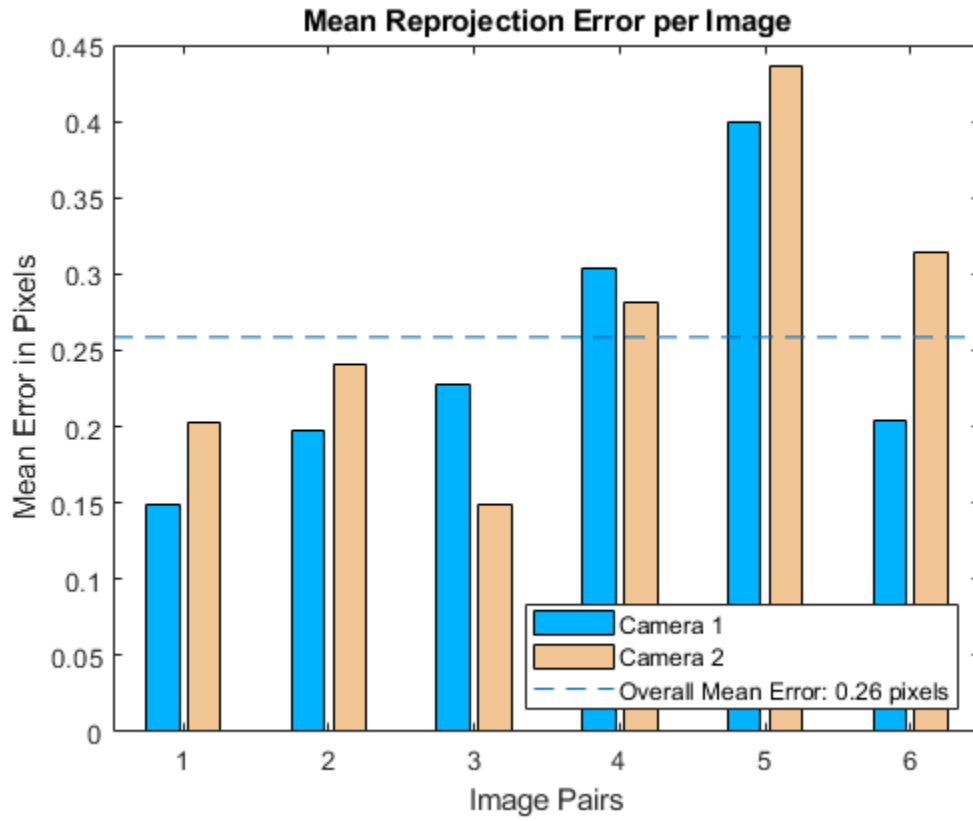

Visualize camera extrinsics.

```
figure  
showExtrinsics(params)
```

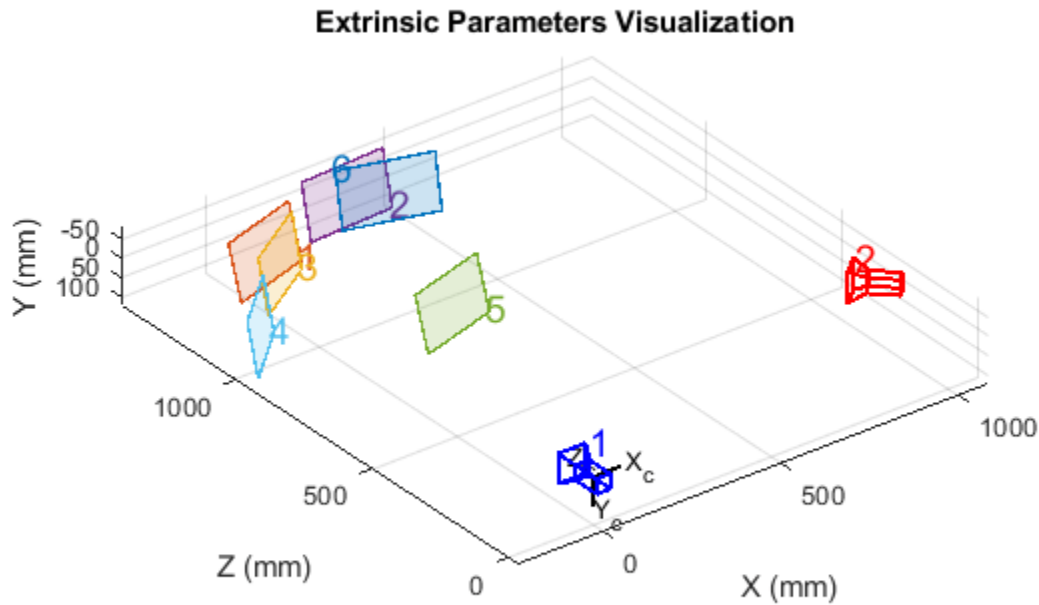

Input Arguments

imagePoints — Key points of calibration pattern

M-by-2-by-*numPairs*-by-2 array

Key points of calibration pattern, specified as an *M*-by-2-by-*numPairs*-by-2 array. The array contains the $[x,y]$ intrinsic image coordinates of key points in the calibration pattern.

- *numPairs* is the number of stereo image pairs containing the calibration pattern.
- The number of keypoint coordinates in each pattern, *M*, must be greater than 3.
- `imagePoints(:, :, :, 1)` are the points from camera 1.
- `imagePoints(:, :, :, 2)` are the points from camera 2.

Data Types: `single` | `double`

worldPoints — Key points of calibration pattern in world coordinates

M-by-2 array

Key points of calibration pattern in world coordinates, specified as an *M*-by-2 array of *M* number of $[x,y]$ world coordinates. The pattern must be planar; therefore, *z*-coordinates are zero.

Data Types: `single` | `double`

intrinsic1 — Intrinsic parameters of camera 1`cameraIntrinsic` object

Intrinsic parameters of camera 1, specified as a `cameraIntrinsic` object. The `intrinsic` object stores information about a camera's intrinsic calibration parameters, including lens distortion.

intrinsic2 — Intrinsic parameters of camera 2`cameraIntrinsic` object

Intrinsic parameters of camera 2, specified as a `cameraIntrinsic` object. The `intrinsic` object stores information about a camera's intrinsic calibration parameters, including lens distortion.

units — World points units`'mm'` (default) | string

World points units, specified as a string representing units.

Output Arguments

stereoParams — Camera parameters for stereo system`stereoParameters` object

Camera parameters for stereo system, returned as a `stereoParameters` object. The object contains the intrinsic, extrinsic, and lens distortion parameters of the stereo camera system.

pairsUsed — Image pairs used to estimate camera parameters`numPairs-by-1` logical vector

Image pairs used to estimate camera parameters, returned as a `numPairs-by-1` logical array. A logical `true` value in the vector indicates which that the image pairs was used to estimate the camera parameters. An image pair will not be used for estimation if the algorithm fails to estimate a homography between the world points and the points detected in that pair of images.

estimationErrors — Standard errors of estimated parameters`stereoCalibrationErrors` object

Standard errors of estimated parameters, returned as a `stereoCalibrationErrors` object.

See Also

Apps**Stereo Camera Calibrator****Classes**`stereoParameters` | `cameraParameters` | `cameraIntrinsic` | `cameraCalibrationErrors` | `stereoCalibrationErrors`**Functions**`estimateCameraParameters` | `detectCheckerboardPoints` | `generateCheckerboardPoints` | `showExtrinsic` | `showReprojectionErrors` | `undistortImage`**Introduced in R2018a**

estimateWorldCameraPose

Estimate camera pose from 3-D to 2-D point correspondences

Syntax

```
[worldOrientation,worldLocation] = estimateWorldCameraPose(imagePoints,
worldPoints,cameraParams)
[ ____,inlierIdx] = estimateWorldCameraPose(imagePoints,worldPoints,
cameraParams)
[ ____,status] = estimateWorldCameraPose(imagePoints,worldPoints,cameraParams)
[ ____ ] = estimateWorldCameraPose( ____,Name,Value)
```

Description

[worldOrientation,worldLocation] = estimateWorldCameraPose(imagePoints, worldPoints,cameraParams) returns the orientation and location of a calibrated camera in a world coordinate system. The input worldPoints must be defined in the world coordinate system.

This function solves the perspective- n -point (PnP) problem using the perspective-three-point (P3P) algorithm [1]. The function also eliminates spurious correspondences using the M-estimator sample consensus (MSAC) algorithm.

[____,inlierIdx] = estimateWorldCameraPose(imagePoints,worldPoints, cameraParams) returns the indices of the inliers used to compute the camera pose, in addition to the arguments from the previous syntax.

[____,status] = estimateWorldCameraPose(imagePoints,worldPoints,cameraParams) additionally returns a status code to indicate whether there were enough points.

[____] = estimateWorldCameraPose(____,Name,Value) uses additional options specified by one or more Name, Value pair arguments, using any of the preceding syntaxes.

Examples

Determine Camera Pose from World-to-Image Correspondences

Load previously calculated world-to-image correspondences.

```
data = load('worldToImageCorrespondences.mat');
```

Estimate the world camera pose.

```
[worldOrientation,worldLocation] = estimateWorldCameraPose(...
    data.imagePoints,data.worldPoints,data.cameraParams);
```

Plot the world points.

```
pcshow(data.worldPoints,'VerticalAxis','Y','VerticalAxisDir','down', ...
    'MarkerSize',30);
hold on
```

```
plotCamera('Size',10,'Orientation',worldOrientation,'Location',...
    worldLocation);
hold off
```

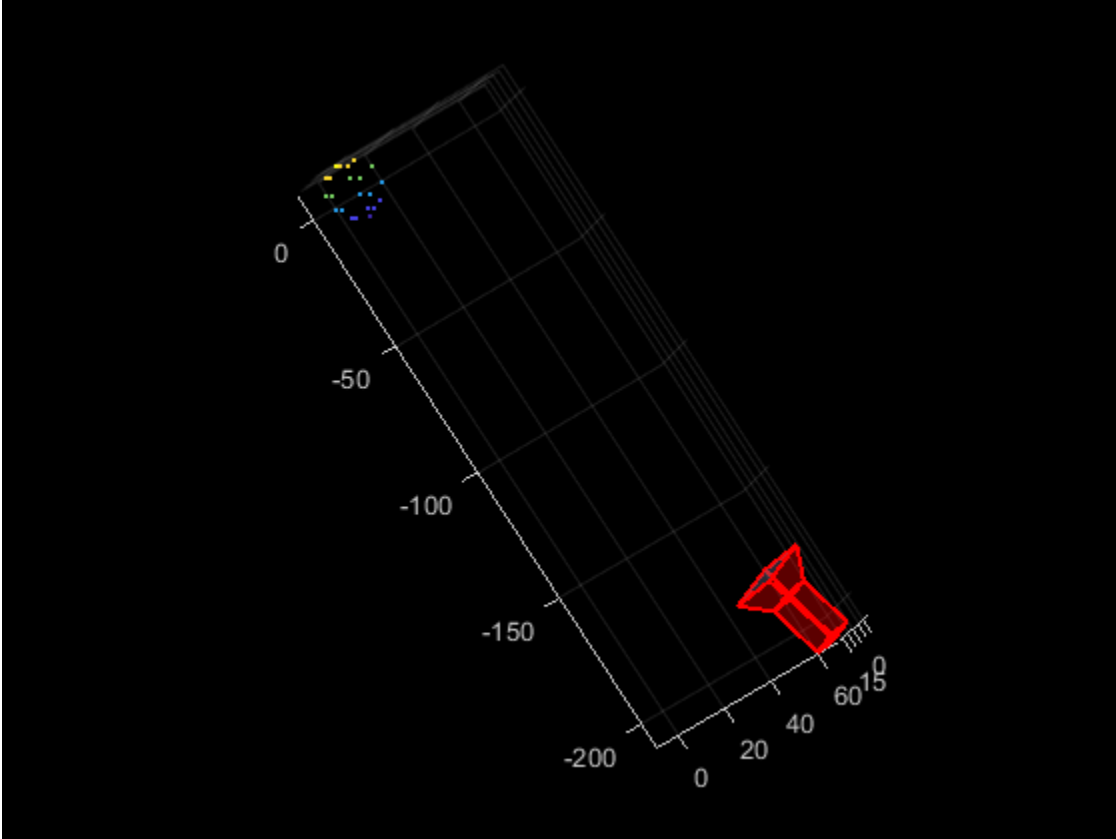

Input Arguments

imagePoints — Coordinates of undistorted image points

M-by-2 array

Coordinates of undistorted image points, specified as an *M*-by-2 array of $[x,y]$ coordinates. The number of image points, *M*, must be at least four.

The function does not account for lens distortion. You can either undistort the images using the `undistortImage` function before detecting the image points, or you can undistort the image points themselves using the `undistortPoints` function.

Data Types: `single` | `double`

worldPoints — Coordinates of world points

M-by-3 array

Coordinates of world points, specified as an *M*-by-3 array of $[x,y,z]$ coordinates.

Data Types: `single` | `double`

cameraParams — Object for storing camera parameters

cameraParameters object | cameraIntrinsics object

Camera parameters, specified as a cameraParameters or cameraIntrinsics object. You can return the cameraParameters object using the estimateCameraParameters function. The cameraParameters object contains the intrinsic, extrinsic, and lens distortion parameters of a camera.

Name-Value Pair Arguments

Specify optional comma-separated pairs of Name, Value arguments. Name is the argument name and Value is the corresponding value. Name must appear inside quotes. You can specify several name and value pair arguments in any order as Name1, Value1, ..., NameN, ValueN.

Example: 'MaxNumTrials',1000

MaxNumTrials — Maximum number of random trials

1000 (default) | positive integer scalar

Maximum number of random trials, specified as the comma-separated pair consisting of 'MaxNumTrials' and a positive integer scalar. The actual number of trials depends on the number of image and world points, and the values for the MaxReprojectionError and Confidence properties. Increasing the number of trials improves the robustness of the output at the expense of additional computation.

Confidence — Confidence for finding maximum number of inliers

99 (default) | scalar in the range (0,100)

Confidence for finding maximum number of inliers, specified as the comma-separated pair consisting of 'Confidence' and a scalar in the range (0,100). Increasing this value improves the robustness of the output at the expense of additional computation.

MaxReprojectionError — Reprojection error threshold

1 (default) | positive numeric scalar

Reprojection error threshold for finding outliers, specified as the comma-separated pair consisting of 'MaxReprojectionError' and a positive numeric scalar in pixels. Increasing this value makes the algorithm converge faster, but can reduce the accuracy of the result.

Output Arguments**worldOrientation — Orientation of camera in world coordinates**

3-by-3 matrix

Orientation of camera in world coordinates, returned as a 3-by-3 matrix.

Data Types: double

worldLocation — Location of camera

1-by-3 vector

Location of camera, returned as a 1-by-3 unit vector.

Data Types: double

inlierIdx — Indices of inlier points*M*-by-1 logical vector

Indices of inlier points, returned as an *M*-by-1 logical vector. A logical true value in the vector corresponds to inliers represented in `imagePoints` and `worldPoints`.

status — Status code

integer value

Status code, returned as 0, 1, or 2.

Status code	Status
0	No error
1	<code>imagePoints</code> and <code>worldPoints</code> do not contain enough points. A minimum of four points are required.
2	Not enough inliers found. A minimum of 4 inliers are required.

References

- [1] Gao, X.-S., X.-R. Hou, J. Tang, and H.F. Cheng. "Complete Solution Classification for the Perspective-Three-Point Problem." *IEEE Transactions on Pattern Analysis and Machine Intelligence*. Volume 25, Issue 8, pp. 930-943, August 2003.
- [2] Torr, P. H. S., and A. Zisserman. "MLESAC: A New Robust Estimator with Application to Estimating Image Geometry." *Computer Vision and Image Understanding*. Volume 78, Issue 1, April 2000, pp. 138-156.

Extended Capabilities**C/C++ Code Generation**

Generate C and C++ code using MATLAB® Coder™.

Usage notes and limitations:

- Use in a MATLAB Function block is not supported.

See Also**Functions**

`relativeCameraPose` | `triangulateMultiview` | `bundleAdjustment` | `plotCamera` | `pcshow` | `extrinsics` | `worldToImage` | `extrinsicsToCameraPose` | `cameraPoseToExtrinsics` | `pointsToWorld` | `viewSet`

Topics

"Structure from Motion Overview"

Introduced in R2016b

cameraPoseToExtrinsics

Convert camera pose to extrinsics

Syntax

```
tform = cameraPoseToExtrinsics(cameraPose)
[rotationMatrix,translationVector] = cameraPoseToExtrinsics(orientation,
location)
```

Description

`tform = cameraPoseToExtrinsics(cameraPose)` returns a `rigid3d` object that contains the transformation from world coordinates to camera coordinates. `cameraPose` is the orientation and location of the camera in world coordinates, specified as a `rigid3d` object.

`[rotationMatrix,translationVector] = cameraPoseToExtrinsics(orientation,location)` returns the camera extrinsics, `rotationMatrix` and `translationVector`, which represent the coordinate system transformation from world coordinates to camera coordinates. The inputs, `orientation` and `location`, represent the 3-D camera pose in the world coordinates.

Examples

Convert World Coordinates to Camera Coordinates

Create the 3-D orientation matrix and the location vector.

```
orientation = eye(3);
location = [0 0 10];
```

Compute the rotation matrix and translation vector to transform points from world coordinates to camera coordinates.

```
[rotationMatrix,translationVector] = cameraPoseToExtrinsics(orientation,location)
```

```
rotationMatrix = 3×3
```

```
    1    0    0
    0    1    0
    0    0    1
```

```
translationVector = 1×3
```

```
    0    0   -10
```

Compute the transformation from world coordinates to camera coordinates as a rigid 3-D object.

```
cameraPose = rigid3d(orientation,location);
tform = cameraPoseToExtrinsics(cameraPose)
```

```
tform =
  rigid3d with properties:

    Rotation: [3x3 double]
    Translation: [0 0 -10]
```

Input Arguments

cameraPose — Orientation and location of the camera

rigid3d object

Orientation and location of the camera in world coordinates, specified as a `rigid3d` object.

orientation — 3-D orientation

3-by-3 matrix

3-D orientation of the camera in world coordinates, specified as a 3-by-3 matrix. The `orientation` and `location` inputs must be the same data type.

Data Types: `double` | `single`

location — 3-D location

three-element vector

3-D location of the camera in world coordinates, specified as a three-element vector. The `orientation` and `location` inputs must be the same data type.

Data Types: `double` | `single`

Output Arguments

tform — Transformation

rigid3d

Transformation from world coordinates to camera coordinates, returned as a `rigid3d` object. The transformation allows you to transform points from the world coordinate system to the camera coordinate system. `tform` is computed as:

```
tform.Rotation = cameraPose.Rotation'
tform.Translation = -cameraPose.Translation * cameraPose.Rotation'
```

rotationMatrix — 3-D rotation

3-by-3 matrix

3-D rotation, returned as a 3-by-3 matrix. The rotation matrix, together with the translation vector allows you to transform points from the world coordinate system to the camera coordinate system.

$$\begin{array}{c}
 [x \ y \ z] = [X \ Y \ Z]R + t \\
 \text{camera coordinates} \quad \text{world coordinates} \quad \text{rotation matrix} \quad \text{translation vector}
 \end{array}$$

The relationship between the rotation matrix and the input orientation matrix is:

rotationMatrix = orientation'

translationVector — 3-D translation

1-by-3 vector

3-D translation, returned as a 1-by-3 vector. The translation vector together with the rotation matrix, enables you to transform points from the world coordinate system to the camera coordinate system.

$$[x \ y \ z] = [X \ Y \ Z]R + t$$

The relationship between the translation vector and the input orientation matrix is :
translationVector = -location*orientation'

Extended Capabilities

C/C++ Code Generation

Generate C and C++ code using MATLAB® Coder™.

See Also

Objects

rigid3d

Functions

extrinsicsToCameraPose | extrinsics | relativeCameraPose | estimateWorldCameraPose

Topics

“Structure From Motion From Two Views”

“Structure From Motion From Multiple Views”

Introduced in R2016b

extrinsicsToCameraPose

Convert extrinsics to camera pose

Syntax

```
cameraPose = extrinsicsToCameraPose(tform)
[orientation,location] = extrinsicsToCameraPose(rotationMatrix,
translationVector)
```

Description

`cameraPose = extrinsicsToCameraPose(tform)` returns a `rigid3d` object that contains the camera pose, `cameraPose`, in world coordinates. `tform` is a transformation from world coordinates to camera coordinates, specified as a `rigid3d` object.

`[orientation,location] = extrinsicsToCameraPose(rotationMatrix, translationVector)` returns 3-D camera pose orientation and location in world coordinates. The inputs, `rotationMatrix` and `translationVector`, represent the transformation from world coordinates to camera coordinates.

Examples

Convert Camera Coordinates to World Coordinates

Create a rotation matrix and a translation vector.

```
rotationMatrix = eye(3);
translationVector = [0 0 -10];
```

Compute the camera orientation matrix and location vector in world coordinates.

```
[orientation,location] = extrinsicsToCameraPose(rotationMatrix,translationVector)
```

```
orientation = 3×3
```

```
    1    0    0
    0    1    0
    0    0    1
```

```
location = 1×3
```

```
    0    0   10
```

Compute the camera pose in world coordinates as a rigid 3-D object.

```
tform = rigid3d(rotationMatrix,translationVector);
cameraPose = extrinsicsToCameraPose(tform)
```

```
cameraPose =
    rigid3d with properties:
```

```
Rotation: [3x3 double]
Translation: [0 0 10]
```

Input Arguments

tform — Transformation

rigid3d object

Transformation from world coordinates to camera coordinates, specified as a rigid3d object. The transformation allows you to transform points from the world coordinate system to the camera coordinate system.

rotationMatrix — 3-D rotation

3-by-3 matrix

3-D rotation, specified as a 3-by-3 matrix. The rotation matrix, together with the translation vector allows you to transform points from the world coordinate system to the camera coordinate system.

Data Types: double | single

translationVector — 3-D translation

1-by-3 vector

3-D translation, specified as a 1-by-3 vector. The translation vector together with the rotation matrix, enables you to transform points from the world coordinate system to the camera coordinate system.

Data Types: double | single

Output Arguments

cameraPose — Camera pose

rigid3d object

Camera pose in world coordinates, returned as a rigid3d object. cameraPose is computed as:

```
cameraPose.Rotation = tform.Rotation'
cameraPose.Translation = -tform.Translation * tform.Rotation'
```

orientation — 3-D orientation

3-by-3 matrix

3-D orientation of the camera in world coordinates, returned as a 3-by-3 matrix.

$$\begin{array}{c}
 [x \ y \ z] \\
 \text{camera coordinates}
 \end{array}
 =
 \begin{array}{c}
 [X \ Y \ Z] \\
 \text{world coordinates}
 \end{array}
 R + t
 \begin{array}{l}
 \text{rotation matrix} \\
 \text{translation vector}
 \end{array}$$

The relationship between the rotation matrix and the output orientation matrix is:
`orientation = rotationMatrix'`

location — 3-D location

3-element vector

3-D location of the camera in world coordinates, specified as a three-element vector.

$$\begin{array}{c} [x \ y \ z] \\ \text{camera coordinates} \end{array} = \begin{array}{c} [X \ Y \ Z] \\ \text{world coordinates} \end{array} \begin{array}{c} R \\ \text{rotation matrix} \end{array} + \begin{array}{c} t \\ \text{translation vector} \end{array}$$

The relationship between the translation vector and the output orientation matrix is:

`location = -translationVector*rotationMatrix'`

Extended Capabilities

C/C++ Code Generation

Generate C and C++ code using MATLAB® Coder™.

See Also

[cameraPoseToExtrinsics](#) | [extrinsics](#) | [relativeCameraPose](#) | [estimateWorldCameraPose](#) | [relativeCameraPose](#) | [estimateWorldCameraPose](#) | [cameraPoseToExtrinsics](#) | [pointsToWorld](#) | [worldToImage](#)

Topics

“Structure From Motion From Two Views”

“Structure From Motion From Multiple Views”

Introduced in R2016b

trainACFObjectDetector

Train ACF object detector

Syntax

```
detector = trainACFObjectDetector(trainingData)
detector = trainACFObjectDetector(trainingData,Name,Value)
```

Description

`detector = trainACFObjectDetector(trainingData)` returns a trained aggregate channel features (ACF) object detector. The function uses positive instances of objects in images given in the `trainingData` table and automatically collects negative instances from the images during training. To create a ground truth table, use the **Image Labeler** or **Video Labeler** app.

`detector = trainACFObjectDetector(trainingData,Name,Value)` returns a detector object with additional options specified by one or more `Name,Value` pair arguments.

Examples

Train Stop Sign Detector Using ACF Object Detector

Use the `trainACFObjectDetector` with training images to create an ACF object detector that can detect stop signs. Test the detector with a separate image.

Load the training data.

```
load('stopSignsAndCars.mat')
```

Select the ground truth for stop signs. These ground truth is the set of known locations of stop signs in the images.

```
stopSigns = stopSignsAndCars(:,1:2);
```

Add the full path to the image files.

```
stopSigns.imageFilename = fullfile(toolboxdir('vision'),...
    'visiondata',stopSigns.imageFilename);
```

Train the ACF detector. You can turn off the training progress output by specifying `'Verbose',false` as a `Name,Value` pair:

```
acfDetector = trainACFObjectDetector(stopSigns,'NegativeSamplesFactor',2);
```

```
ACF Object Detector Training
```

```
The training will take 4 stages. The model size is 34x31.
```

```
Sample positive examples(~100% Completed)
```

```
Compute approximation coefficients...Completed.
```

```
Compute aggregated channel features...Completed.
```

```
-----
```

```
Stage 1:
```

```
Sample negative examples(~100% Completed)
Compute aggregated channel features...Completed.
Train classifier with 42 positive examples and 84 negative examples...Completed.
The trained classifier has 19 weak learners.
-----
```

Stage 2:

```
Sample negative examples(~100% Completed)
Found 84 new negative examples for training.
Compute aggregated channel features...Completed.
Train classifier with 42 positive examples and 84 negative examples...Completed.
The trained classifier has 20 weak learners.
-----
```

Stage 3:

```
Sample negative examples(~100% Completed)
Found 84 new negative examples for training.
Compute aggregated channel features...Completed.
Train classifier with 42 positive examples and 84 negative examples...Completed.
The trained classifier has 54 weak learners.
-----
```

Stage 4:

```
Sample negative examples(~100% Completed)
Found 84 new negative examples for training.
Compute aggregated channel features...Completed.
Train classifier with 42 positive examples and 84 negative examples...Completed.
The trained classifier has 61 weak learners.
-----
```

ACF object detector training is completed. Elapsed time is 20.1934 seconds.

Test the ACF detector on a test image.

```
img = imread('stopSignTest.jpg');
```

```
[bboxes,scores] = detect(acfDetector,img);
```

Display the detection results and insert the bounding boxes for objects into the image.

```
for i = 1:length(scores)
    annotation = sprintf('Confidence = %.1f',scores(i));
    img = insertObjectAnnotation(img,'rectangle',bboxes(i,:),annotation);
end
```

```
figure
imshow(img)
```



Input Arguments

trainingData — Labeled ground truth images

table

Labeled ground truth images, specified as a table with two columns. The first column must contain paths and file names to grayscale or truecolor (RGB) images. Although, ACF-based detectors work best with truecolor images. The second column contains M -by-4 matrices, that contain the locations of the bounding boxes related to the corresponding image. The locations are in the format, $[x,y,width,height]$. The second column represents a positive instance of a single object class, such as a car, dog, flower, or stop sign. Negative instances are automatically collected from images during the training process.

	1 imageFilename	2 stopSign
1	'stopSignImages/image005.jpg'	[980,393,31,56]
2	'stopSignImages/image006.jpg'	[1.0408e+03,354.7500,73,72]
3	'stopSignImages/image009.jpg'	[635,254,65,63]
4	'stopSignImages/image013.jpg'	[398.2050,261.2996,349.6806,385.6992]
5	'stopSignImages/image014.jpg'	[365.1880,306.3229,357.1845,421.7178]
6	'stopSignImages/image020.jpg'	[653.7500,307.7500,73.0000,76]
7	'stopSignImages/image021.jpg'	[589.7500,239.7500,181,196.0000]
8	'stopSignImages/image022.jpg'	[509.7500,470.7500,43,73]
9	'stopSignImages/image023.jpg'	[497.7500,19.901]

Each bounding box must be in the format $[x,y,width,height]$. The format specifies the upper-left corner location and the size of the object in the corresponding image. The table variable (column) name defines the object class name. To create the ground truth table, use the **Image Labeler** app.

Name-Value Pair Arguments

Specify optional comma-separated pairs of Name, Value arguments. Name is the argument name and Value is the corresponding value. Name must appear inside quotes. You can specify several name and value pair arguments in any order as Name1, Value1, ..., NameN, ValueN.

Example: 'ObjectTrainingSize', [100 100]

ObjectTrainingSize — Size of objects during training

'Auto' (default) | 2-element vector

Size of objects during training, specified as a 2-element vector of the form $[height\ width]$ in pixels. The minimum training size is $[8\ 8]$. During the training process, objects are resized to the height and width specified by 'ObjectTrainingSize'. Increasing the size can improve detection accuracy, but also increases training and detection times.

When you specify 'Auto', the size is set based on the median width-to-height ratio of the positive instances.

Example: [100,100]

Data Types: single | double | int8 | int16 | int32 | int64 | uint8 | uint16 | uint32 | uint64

NumStages — Number of training stages

4 (default) | positive integer

Number of training stages for the iterative training process, specified as the comma-separated pair consisting of 'NumStages' and a positive integer. Increasing this number can improve the detector and reduce training errors, at the expense of longer training time.

Data Types: double

NegativeSamplesFactor — Negative sample factor

5 (default) | real-valued scalar

Negative sample factor, specified as the comma-separated pair consisting of 'NegativeSamplesFactor' and a real-valued scalar. The number of negative samples to use at each stage is equal to

`NegativeSamplesFactor` × *number of positive samples used at each stage*

Data Types: double

MaxWeakLearners — Maximum number of weak learners

2048 (default) | positive integer scalar | vector of positive integers

Maximum number of weak learners for the last stage, specified as the comma-separated pair consisting of 'MaxWeakLearners' and a positive integer scalar or vector of positive integers. If the input is a scalar, `MaxWeakLearners` specifies the maximum number for the last stage. If the input is a vector, `MaxWeakLearners` specifies the maximum number for each of the stages and must have a length equal to 'NumStages'. These values typically increase throughout the stages. The ACF object detector uses the boosting algorithm to create an ensemble of weaker learners. You can use higher values to improve the detection accuracy, at the expense of reduced detection performance speeds. Recommended values range from 300 to 5000.

Data Types: double

Verbose — Display progress information

true (default) | false

Option to display progress information for the training process, specified as the comma-separated pair consisting of 'Verbose' and true or false.

Data Types: logical

Output Arguments

detector — Trained ACF-based object detector

acfObjectDetector object

Trained ACF-based object detector, returned as an `acfObjectDetector` object.

See Also

Apps

Image Labeler | **Video Labeler**

Functions

acfObjectDetector | trainRCNNObjectDetector | trainCascadeObjectDetector | detectPeopleACF

Introduced in R2017a

trainRCNNObjectDetector

Train an R-CNN deep learning object detector

Syntax

```
detector = trainRCNNObjectDetector(trainingData, network, options)
detector = trainRCNNObjectDetector( ___, Name, Value)
detector = trainRCNNObjectDetector( ___, 'RegionProposalFcn', proposalFcn)
[detector, info] = trainRCNNObjectDetector( ___)

detector = trainRCNNObjectDetector( ___, Name, Value)
```

Description

`detector = trainRCNNObjectDetector(trainingData, network, options)` trains an R-CNN (regions with convolutional neural networks) based object detector. The function uses deep learning to train the detector to detect multiple object classes.

This implementation of R-CNN does not train an SVM classifier for each object class.

This function requires that you have Deep Learning Toolbox and Statistics and Machine Learning Toolbox. It is recommended that you also have Parallel Computing Toolbox to use with a CUDA-enabled NVIDIA GPU. For information about the supported compute capabilities, see “GPU Support by Release” (Parallel Computing Toolbox).

`detector = trainRCNNObjectDetector(___, Name, Value)` returns a detector object with optional input properties specified by one or more `Name, Value` pair arguments.

`detector = trainRCNNObjectDetector(___, 'RegionProposalFcn', proposalFcn)` optionally trains an R-CNN detector using a custom region proposal function.

`[detector, info] = trainRCNNObjectDetector(___)` also returns information on the training progress, such as training loss and accuracy, for each iteration.

`detector = trainRCNNObjectDetector(___, Name, Value)` uses additional options specified by one or more `Name, Value` pair arguments and any of the previous inputs.

Examples

Train R-CNN Stop Sign Detector

Load training data and network layers.

```
load('rcnnStopSigns.mat', 'stopSigns', 'layers')
```

Add the image directory to the MATLAB path.

```
imDir = fullfile(matlabroot, 'toolbox', 'vision', 'visiondata', ...
    'stopSignImages');
addpath(imDir);
```

Set network training options to use mini-batch size of 32 to reduce GPU memory usage. Lower the InitialLearningRate to reduce the rate at which network parameters are changed. This is beneficial when fine-tuning a pre-trained network and prevents the network from changing too rapidly.

```
options = trainingOptions('sgdm', ...
    'MiniBatchSize', 32, ...
    'InitialLearnRate', 1e-6, ...
    'MaxEpochs', 10);
```

Train the R-CNN detector. Training can take a few minutes to complete.

```
rcnn = trainRCNNObjectDetector(stopSigns, layers, options, 'NegativeOverlapRange', [0 0.3]);
```

```
*****
```

```
Training an R-CNN Object Detector for the following object classes:
```

```
* stopSign
```

```
Step 1 of 3: Extracting region proposals from 27 training images...done.
```

```
Step 2 of 3: Training a neural network to classify objects in training data...
```

Epoch	Iteration	Time Elapsed (seconds)	Mini-batch Loss	Mini-batch Accuracy	Base Learning Rate
3	50	9.27	0.2895	96.88%	0.000001
5	100	14.77	0.2443	93.75%	0.000001
8	150	20.29	0.0013	100.00%	0.000001
10	200	25.94	0.1524	96.88%	0.000001

```
Network training complete.
```

```
Step 3 of 3: Training bounding box regression models for each object class...100.00%...done.
```

```
R-CNN training complete.
```

```
*****
```

Test the R-CNN detector on a test image.

```
img = imread('stopSignTest.jpg');
```

```
[bbox, score, label] = detect(rcnn, img, 'MiniBatchSize', 32);
```

Display strongest detection result.

```
[score, idx] = max(score);
```

```
bbox = bbox(idx, :);
```

```
annotation = sprintf('%s: (Confidence = %f)', label(idx), score);
```

```
detectedImg = insertObjectAnnotation(img, 'rectangle', bbox, annotation);
```

```
figure
```

```
imshow(detectedImg)
```



Remove the image directory from the path.

```
rmpath(imDir);
```

Resume Training an R-CNN Object Detector

Resume training an R-CNN object detector using additional data. To illustrate this procedure, half the ground truth data will be used to initially train the detector. Then, training is resumed using all the data.

Load training data and initialize training options.

```
load('rcnnStopSigns.mat', 'stopSigns', 'layers')
```

```
stopSigns.imageFilename = fullfile(toolboxdir('vision'),'visiondata', ...  
    stopSigns.imageFilename);
```

```
options = trainingOptions('sgdm', ...  
    'MiniBatchSize', 32, ...  
    'InitialLearnRate', 1e-6, ...  
    'MaxEpochs', 10, ...  
    'Verbose', false);
```

Train the R-CNN detector with a portion of the ground truth.

```
rcnn = trainRCNNObjectDetector(stopSigns(1:10,:), layers, options, 'NegativeOverlapRange', [0 0.5]);
```

Get the trained network layers from the detector. When you pass in an array of network layers to `trainRCNNObjectDetector`, they are used as-is to continue training.

```
network = rcnn.Network;
layers = network.Layers;
```

Resume training using all the training data.

```
rcnnFinal = trainRCNNObjectDetector(stopSigns, layers, options);
```

Create a network for multiclass R-CNN object detection

Create an R-CNN object detector for two object classes: dogs and cats.

```
objectClasses = {'dogs', 'cats'};
```

The network must be able to classify both dogs, cats, and a "background" class in order to be trained using `trainRCNNObjectDetector`. In this example, a one is added to include the background.

```
numClassesPlusBackground = numel(objectClasses) + 1;
```

The final fully connected layer of a network defines the number of classes that the network can classify. Set the final fully connected layer to have an output size equal to the number of classes plus a background class.

```
layers = [ ...
    imageInputLayer([28 28 1])
    convolution2dLayer(5,20)
    fullyConnectedLayer(numClassesPlusBackground);
    softmaxLayer()
    classificationLayer()];
```

These network layers can now be used to train an R-CNN two-class object detector.

Use A Saved Network In R-CNN Object Detector

Create an R-CNN object detector and set it up to use a saved network checkpoint. A network checkpoint is saved every epoch during network training when the `trainingOptions` 'CheckpointPath' parameter is set. Network checkpoints are useful in case your training session terminates unexpectedly.

Load the stop sign training data.

```
load('rcnnStopSigns.mat', 'stopSigns', 'layers')
```

Add full path to image files.

```
stopSigns.imageFilename = fullfile(toolboxdir('vision'),'visiondata', ...
    stopSigns.imageFilename);
```

Set the 'CheckpointPath' using the `trainingOptions` function.

```
checkpointLocation = tempdir;
options = trainingOptions('sgdm','Verbose',false, ...
    'CheckpointPath',checkpointLocation);
```

Train the R-CNN object detector with a few images.

```
rcnn = trainRCNNObjectDetector(stopSigns(1:3,:),layers,options);
```

Load a saved network checkpoint.

```
wildcardFilePath = fullfile(checkpointLocation,'convnet_checkpoint_*.mat');
contents = dir(wildcardFilePath);
```

Load one of the checkpoint networks.

```
filepath = fullfile(contents(1).folder,contents(1).name);
checkpoint = load(filepath);
```

```
checkpoint.net
```

```
ans =
```

```
SeriesNetwork with properties:
    Layers: [15x1 nnet.cnn.layer.Layer]
```

Create a new R-CNN object detector and set it up to use the saved network.

```
rcnnCheckPoint = rcnnObjectDetector();
rcnnCheckPoint.RegionProposalFcn = @rcnnObjectDetector.proposeRegions;
```

Set the Network to the saved network checkpoint.

```
rcnnCheckPoint.Network = checkpoint.net
```

```
rcnnCheckPoint =
```

```
rcnnObjectDetector with properties:
    Network: [1x1 SeriesNetwork]
    ClassNames: {'stopSign' 'Background'}
    RegionProposalFcn: @rcnnObjectDetector.proposeRegions
```

Input Arguments

trainingData — Labeled ground truth images

table

Labeled ground truth images, specified as a table with two or more columns.

If you use a table, the table must have two or more columns. The first column of the table must contain image file names with paths. The images must be grayscale or truecolor (RGB) and they can be in any format supported by `imread`. Each of the remaining columns must be a cell vector that contains M -by-4 matrices that represent a single object class, such as *vehicle*, *flower*, or *stop sign*. The columns contain 4-element double arrays of M bounding boxes in the format `[x,y,width,height]`. The format specifies the upper-left corner location and size of the bounding box in the corresponding image. To create a ground truth table, you can use the **Image Labeler** app or **Video Labeler** app. To create a table of training data from the generated ground truth, use the `objectDetectorTrainingData` function.

	1 imageFilename	2 stopSign
1	'stopSignImages/image005.jpg'	[980,393,31,56]
2	'stopSignImages/image006.jpg'	[1.0408e+03,354.7500,73,72]
3	'stopSignImages/image009.jpg'	[635,254,65,63]
4	'stopSignImages/image013.jpg'	[398.2050,261.2996,349.6806,385.6992]
5	'stopSignImages/image014.jpg'	[365.1880,306.3229,357.1845,421.7178]
6	'stopSignImages/image020.jpg'	[653.7500,307.7500,73.0000,76]
7	'stopSignImages/image021.jpg'	[589.7500,239.7500,181,196.0000]
8	'stopSignImages/image022.jpg'	[509.7500,470.7500,43,73]
9	'stopSignImages/image023.jpg'	[407,19,901]

The table variable name defines the object class name. To create the ground truth table, use the **Image Labeler** app. Boxes smaller than 32-by-32 are not used for training.

network — Network

SeriesNetwork object | array of Layer objects | LayerGraph object | network name

Network, specified as a SeriesNetwork, an array of Layer objects, a LayerGraph object, or by the network name. The network is trained to classify the object classes defined in the trainingData table. The SeriesNetwork, Layer, and layerGraph objects are available in the Deep Learning Toolbox.

- When you specify the network as a SeriesNetwork, an array of Layer objects, or by the network name, the network is automatically transformed into a R-CNN network by adding new classification and regression layers to support object detection.
- The array of Layer objects must contain a classification layer that supports the number of object classes, plus a background class. Use this input type to customize the learning rates of each layer. An example of an array of Layer objects:

```
layers = [imageInputLayer([28 28 3])
          convolution2dLayer([5 5],10)
          reluLayer()
          fullyConnectedLayer(10)
          softmaxLayer()
          classificationLayer()];
```

- When you specify the network as SeriesNetwork, Layer array, or network by name, the weights for convolution and fully-connected layers are initialized to 'narrow-normal'.
- The network name must be one of the following valid networks names. You must also install the corresponding Add-on.
 - 'alexnet'
 - 'vgg16'
 - 'vgg19'
 - 'resnet18'

- 'resnet50'
- 'resnet101'
- 'inceptionv3'
- 'googlenet'
- 'inceptionresnetv2'
- 'squeezenet'
- 'mobilenetv2'
- The LayerGraph object must be a valid R-CNN object detection network. You can also use a LayerGraph object to train a custom R-CNN network.

See “Getting Started with R-CNN, Fast R-CNN, and Faster R-CNN” to learn more about how to create a R-CNN network.

options — Training options

trainingOptions output

Training options, returned by the trainingOptions function from the Deep Learning Toolbox. To specify solver and other options for network training, use trainingOptions.

Note trainRCNNObjectDetector does not support these training options:

- The ValidationData, ValidationFrequency, or ValidationPatience options
-

Name-Value Pair Arguments

Specify optional comma-separated pairs of Name, Value arguments. Name is the argument name and Value is the corresponding value. Name must appear inside quotes. You can specify several name and value pair arguments in any order as Name1, Value1, . . . , NameN, ValueN.

Example: 'PositiveOverlapRange',[0.5 1].

PositiveOverlapRange — Positive training sample ratios for range of bounding box overlap

[0.5 1] (default) | two-element vector

Positive training sample ratios for range of bounding box overlap, specified as the comma-separated pair consisting of 'PositiveOverlapRange' and a two-element vector. The vector contains values in the range [0,1]. Region proposals that overlap with ground truth bounding boxes within the specified range are used as positive training samples.

The overlap ratio used for both the PositiveOverlapRange and NegativeOverlapRange is defined as:

$$\frac{\text{area}(A \cap B)}{\text{area}(A \cup B)}$$

A and B are bounding boxes.

NegativeOverlapRange — Negative training sample ratios for range of bounding box overlap

[0.1 0.5] (default) | two-element vector

Negative training sample ratios for range of bounding box overlap, specified as the comma-separated pair consisting of 'NegativeOverlapRange' and a two-element vector. The vector contains values in the range [0,1]. Region proposals that overlap with the ground truth bounding boxes within the specified range are used as negative training samples.

NumStrongestRegions — Maximum number of strongest region proposals

2000 (default) | integer

Maximum number of strongest region proposals to use for generating training samples, specified as the comma-separated pair consisting of 'NumStrongestRegions' and an integer. Reduce this value to speed up processing time, although doing so decreases training accuracy. To use all region proposals, set this value to `inf`.

RegionProposalFcn — Custom region proposal

function handle

Custom region proposal function handle, specified as the comma-separated pair consisting of 'RegionProposalFcn' and the function name. If you do not specify a custom region proposal function, the default variant of the Edge Boxes algorithm [3], set in `rcnnObjectDetector`, is used. A custom proposalFcn must have the following functional form:

```
[bboxes,scores] = proposalFcn(I)
```

The input, `I`, is an image defined in the `groundTruth` table. The function must return rectangular bounding boxes in an M -by-4 array. Each row of `bboxes` contains a four-element vector, `[x,y,width,height]`, that specifies the upper-left corner and size of a bounding box in pixels. The function must also return a score for each bounding box in an M -by-1 vector. Higher scores indicate that the bounding box is more likely to contain an object. The scores are used to select the strongest regions, which you can specify in `NumStrongestRegions`.

BoxRegressionLayer — Box regression layer name

'auto' (default) | character vector

Box regression layer name, specified as the comma-separated pair consisting of 'BoxRegressionLayer' and a character vector. Valid values are 'auto' or the name of a layer in the input network. The output activations of this layer are used as features to train a regression model for refining the detected bounding boxes.

If the name is 'auto', then `trainRCNNObjectDetector` automatically selects a layer from the input network based on the type of input network:

- If the input network is a `SeriesNetwork` or an array of `Layer` objects, then the function selects the last convolution layer.
- If the input network is a `LayerGraph`, then the function selects the source of the last fully connected layer.

ExperimentManager — Detector training experiment monitoring

'none' (default) | `experiments.Monitor` object

Detector training experiment monitoring, specified as an `experiments.Monitor` object for use with the **Experiment Manager** app. You can use this object to track the progress of training, update information fields in the training results table, record values of the metrics used by the training, and to produce training plots.

Information monitored during training:

- Training loss at each iteration.
- Training accuracy at each iteration.
- Training root mean square error (RMSE) for the box regression layer.
- Learning rate at each iteration.

Output Arguments

detector — Trained R-CNN-based object detector

`rcnnObjectDetector` object

Trained R-CNN-based object detector, returned as an `rcnnObjectDetector` object. You can train an R-CNN detector to detect multiple object classes.

info — Training information

structure

Training information, returned as a structure with the following fields. Each field is a numeric vector with one element per training iteration. Values that have not been calculated at a specific iteration are represented by NaN.

- `TrainingLoss` — Training loss at each iteration. This is the combination of the classification and regression loss used to train the R-CNN network.
- `TrainingAccuracy` — Training set accuracy at each iteration
- `BaseLearnRate` — Learning rate at each iteration

Limitations

- This implementation of R-CNN does not train an SVM classifier for each object class.

Tips

- To accelerate data preprocessing for training, `trainRCNNObjectDetector` automatically creates and uses a parallel pool based on your parallel preference settings. This requires Parallel Computing Toolbox.
- VGG-16, VGG-19, ResNet-101, and Inception-ResNet-v2 are large models. Training with large images may produce "Out of Memory" errors. To mitigate these errors, manually resize the images along with the bounding box ground truth data before calling `trainRCNNObjectDetector`.
- This function supports transfer learning. When a network is input by name, such as `'resnet50'`, then the software automatically transforms the network into a valid R-CNN network model based on the pretrained `resnet50` model. Alternatively, manually specify a custom R-CNN network using the `LayerGraph` extracted from a pretrained DAG network. See "Create R-CNN Object Detection Network".
- Use the `trainingOptions` function to enable or disable verbose printing.

References

- [1] Girshick, R., J. Donahue, T. Darrell, and J. Malik. "Rich Feature Hierarchies for Accurate Object Detection and Semantic Segmentation." *Proceedings of the IEEE Conference on Computer Vision and Pattern Recognition*. 2014, pp. 580–587.

- [2] Girshick, R. "Fast R-CNN." *Proceedings of the IEEE International Conference on Computer Vision*. 2015, pp. 1440-1448.
- [3] Zitnick, C. Lawrence, and P. Dollar. "Edge Boxes: Locating Object Proposals from Edges." *Computer Vision-ECCV, Springer International Publishing*. 2014, pp. 391-405.

Extended Capabilities

Automatic Parallel Support

Accelerate code by automatically running computation in parallel using Parallel Computing Toolbox™.

To run in parallel, set 'UseParallel' to true or enable this by default using the Computer Vision Toolbox preferences.

For more information, see "Parallel Computing Toolbox Support".

See Also

Apps

[Image Labeler](#) | [Video Labeler](#)

Functions

[trainingOptions](#) | [trainFastRCNNObjectDetector](#) | [trainFasterRCNNObjectDetector](#) | [trainYOLOv2ObjectDetector](#) | [objectDetectorTrainingData](#) | [resnet50](#)

Objects

[SeriesNetwork](#) | [Layer](#) | [rcnnObjectDetector](#) | [imageCategoryClassifier](#)

Topics

["Image Category Classification Using Deep Learning"](#)

["Anchor Boxes for Object Detection"](#)

["Getting Started with R-CNN, Fast R-CNN, and Faster R-CNN"](#)

Introduced in R2016b

estimateGeometricTransform2D

Estimate 2-D geometric transformation from matching point pairs

Syntax

```
tform = estimateGeometricTransform2D(matchedPoints1,matchedPoints2,  
transformType)  
[tform,inlierIndex] = estimateGeometricTransform2D( ___ )  
[tform,inlierIndex,status] = estimateGeometricTransform2D( ___ )  
[ ___ ] = estimateGeometricTransform2D( ___ , Name,Value)
```

Description

`tform = estimateGeometricTransform2D(matchedPoints1,matchedPoints2, transformType)` estimates a 2-D geometric transformation between two images by mapping the inliers in the matched points from one image `matchedPoints1` to the inliers in the matched points from another image `matchedPoints2`.

`[tform,inlierIndex] = estimateGeometricTransform2D(___)` additionally returns a vector specifying each matched point pair as either an inlier or an outlier using the input arguments from the previous syntax.

`[tform,inlierIndex,status] = estimateGeometricTransform2D(___)` additionally returns a status code indicating whether or not the function could estimate a transformation and, if not, why it failed. If you do not specify the `status` output, the function instead returns an error for conditions that cannot produce results.

`[___] = estimateGeometricTransform2D(___ , Name,Value)` specifies additional options using one or more name-value pair arguments in addition to any combination of arguments from previous syntaxes. For example, `'Confidence',99` sets the confidence value for finding the maximum number of inliers to 99.

Examples

Recover Transformed Image Using SURF Feature Points

Read an image and display it.

```
original = imread('cameraman.tif');  
imshow(original)  
title('Base Image')
```

Base image

Distort and display the transformed image.

```
distorted = imresize(original,0.7);  
distorted = imrotate(distorted,31);  
figure  
imshow(distorted)  
title('Transformed Image')
```

Transformed image

Detect and extract features from the original and the transformed images.

```
ptsOriginal = detectSURFFeatures(original);
ptsDistorted = detectSURFFeatures(distorted);
[featuresOriginal,validPtsOriginal] = extractFeatures(original,ptsOriginal);
[featuresDistorted,validPtsDistorted] = extractFeatures(distorted,ptsDistorted);
```

Match and display features between the images.

```
index_pairs = matchFeatures(featuresOriginal,featuresDistorted);
matchedPtsOriginal = validPtsOriginal(index_pairs(:,1));
matchedPtsDistorted = validPtsDistorted(index_pairs(:,2));
figure
showMatchedFeatures(original,distorted,matchedPtsOriginal,matchedPtsDistorted)
title('Matched SURF Points With Outliers');
```

Matched SURF points,including outliers



Exclude the outliers, estimate the transformation matrix, and display the results.

```
[tform,inlierIdx] = estimateGeometricTransform2D(matchedPtsDistorted,matchedPtsOriginal,'similar');
inlierPtsDistorted = matchedPtsDistorted(inlierIdx,:);
inlierPtsOriginal = matchedPtsOriginal(inlierIdx,:);
```

```
figure
showMatchedFeatures(original,distorted,inlierPtsOriginal,inlierPtsDistorted)
title('Matched Inlier Points')
```

Matched inlier points

Use the estimated transformation to recover and display the original image from the distorted image.

```
outputView = imref2d(size(original));  
Ir = imwarp(distorted,tform,'OutputView',outputView);  
figure  
imshow(Ir);  
title('Recovered Image');
```

Recovered image

Input Arguments

matchedPoints1 — Matched points from first image

cornerPoints object | SURFPoints object | MSERRegions object | ORBPoints object | BRISKPoints object | KAZEPoints object | M -by-2 matrix of $[x,y]$ coordinates

Matched points from the first image, specified as either a KAZEPoints object, cornerPoints object, SURFPoints object, MSERRegions object, ORBPoints object, BRISKPoints object, or an M -by-2 matrix in which each row is a pair of $[x,y]$ coordinates and M is the number of matched points.

matchedPoints2 — Matched points from second image

cornerPoints object | SURFPoints object | MSERRegions object | ORBPoints object | BRISKPoints object | KAZEPoints object | M -by-2 matrix of $[x,y]$ coordinates

Matched points from the second image, specified as either a KAZEPoints object, cornerPoints object, SURFPoints object, MSERRegions object, ORBPoints object, BRISKPoints object, or an M -by-2 matrix in which each row is a pair of $[x,y]$ coordinates and M is the number of matched points.

transformType — Transformation type

'rigid' | 'similarity' | 'affine' | 'projective'

Transformation type, specified as a character string. You can set the transform type to 'rigid', 'similarity', 'affine', or 'projective'. Each transform type requires a minimum number of matched pairs of points to estimate a transformation. You can generally improve the accuracy of a transformation by using a larger number of matched pairs of points. This table shows the type of object associated with each transformation type and the minimum number of matched pairs of points the transformation requires.

Transformation Type	tform Object	Minimum Number of Matched Pairs of Points
'rigid'	rigid2d	2
'similarity'	affine2d	2
'affine'	affine2d	3
'projective'	projective2d	4

Data Types: string

Name-Value Pair Arguments

Specify optional comma-separated pairs of Name, Value arguments. Name is the argument name and Value is the corresponding value. Name must appear inside quotes. You can specify several name and value pair arguments in any order as Name1, Value1, ..., NameN, ValueN.

Example: 'Confidence',99 sets the confidence value for finding the maximum number of inliers to 99.

MaxNumTrials — Maximum random trials

1000 (default) | positive integer

Maximum number of random trials, specified as the comma-separated pair consisting of 'MaxNumTrials' and a positive integer. This value specifies the number of randomized attempts the

function makes to find matching point pairs. Specifying a higher value causes the function to perform additional computations, which increases the likelihood of finding inliers.

Data Types: `single` | `double` | `int8` | `int16` | `int32` | `int64` | `uint8` | `uint16` | `uint32` | `uint64`

Confidence — Confidence of finding maximum number of inliers

99 (default) | positive numeric scalar

Confidence of finding the maximum number of inliers, specified as the comma-separated pair consisting of 'Confidence' and a positive numeric scalar in the range (0, 100). Increasing this value causes the function to perform additional computations, which increases the likelihood of finding a greater number of inliers.

Data Types: `single` | `double` | `int8` | `int16` | `int32` | `int64` | `uint8` | `uint16` | `uint32` | `uint64`

MaxDistance — Maximum distance from point to projection

1.5 (default) | positive numeric scalar

Maximum distance from a point to the projection of the corresponding point, specified as the comma-separated pair consisting of 'MaxDistance' and a positive numeric scalar. 'MaxDistance' specifies the maximum distance, in pixels, that a point can differ from the projected location of its corresponding point to be considered an inlier. The corresponding projection is based on the estimated transform.

The function checks for a transformation from `matchedPoints1` to `matchedPoints2`, and then calculates the distance between the matched points in each pair after applying the transformation. If the distance between the matched points in a pair is greater than the 'MaxDistance' value, then the pair is considered an outlier for that transformation. If the distance is less than 'MaxDistance', then the pair is considered an inlier.

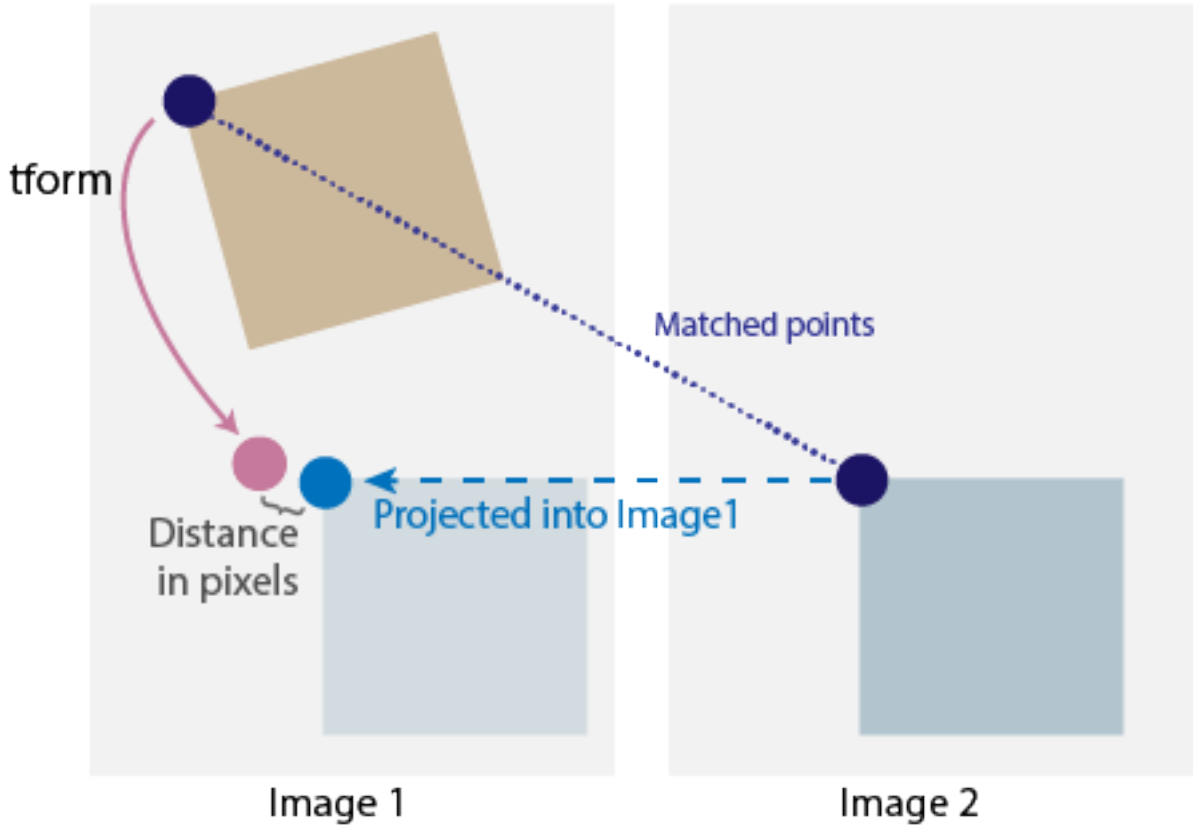

Data Types: single | double | int8 | int16 | int32 | int64 | uint8 | uint16 | uint32 | uint64

Output Arguments

tform — Geometric transformation

rigid2d object | affine2d object | projective2d object

Geometric transformation, returned as a rigid2d, affine2d, or projective2d object.

The returned geometric transformation matrix maps the inliers in matchedPoints1 to the inliers in matchedPoints2. The function returns an object specific to the transformation type specified by the transformType input argument.

transformType	tform
'rigid'	rigid2d
'similarity'	affine2d
'affine'	affine2d
'projective'	projective2d

status — Status code

0 | 1 | 2

Status code, returned as 0, 1, or 2. The status code indicates whether or not the function could estimate the transformation and, if not, why it failed.

Value	Description
0	No error
1	matchedPoints1 and matchedPoints2 inputs do not contain enough points
2	Not enough inliers found

If you do not specify the status code output, the function returns an error if it cannot produce results.

Data Types: int32

inlierIndex — Index of inliers

M-by-1 logical vector

Index of inliers, returned as an *M*-by-1 logical vector, where *M* is the number of point pairs. Each element contains either a logical 1 (`true`), indicating that the corresponding point pair is an inlier, or a logical 0 (`false`), indicating that the corresponding point pair is an outlier.

Algorithms

The function excludes outliers using the M-estimator sample consensus (MSAC) algorithm. The MSAC algorithm is a variant of the random sample consensus (RANSAC) algorithm. Results may not be identical between runs due to the randomized nature of the MSAC algorithm.

References

- [1] Hartley, Richard, and Andrew Zisserman. *Multiple View Geometry in Computer Vision*. 2nd ed. Cambridge, UK; New York: Cambridge University Press, 2003.
- [2] Torr, P.H.S., and A. Zisserman. "MLE-SAC: A New Robust Estimator with Application to Estimating Image Geometry." *Computer Vision and Image Understanding* 78, no. 1 (April 2000): 138-56. <https://doi.org/10.1006/cviu.1999.0832>.

Extended Capabilities

C/C++ Code Generation

Generate C and C++ code using MATLAB® Coder™.

Usage notes and limitations:

- You cannot use SURFPoints object as an input to estimateGeometricTransform2D. See the "Introduction to Code Generation with Feature Matching and Registration" example for details on how to use SURFPoints with estimateGeometricTransform2D in codegen.

See Also

Functions

rgb2gray | estimateGeometricTransform3D | estimateFundamentalMatrix | detectSURFFeatures | detectMinEigenFeatures | detectORBFeatures | detectFASTFeatures | detectMSERFeatures | extractFeatures | matchFeatures | fitgeotrans

Objects

KAZEPoints | cornerPoints | MSERRegions | SURFPoints | ORBPoints | BRISKPoints

Topics

“Feature Based Panoramic Image Stitching”

“Point Feature Types”

“Coordinate Systems”

“2-D and 3-D Geometric Transformation Process Overview”

“Introduction to Code Generation with Feature Matching and Registration”

Introduced in R2020b

estimateGeometricTransform3D

Estimate 3-D geometric transformation from matching point pairs

Syntax

```
tform = estimateGeometricTransform3D(matchedPoints1,matchedPoints2,
transformType)
[tform,inlierIndex] = estimateGeometricTransform3D(____)
[tform,inlierIndex,status] = estimateGeometricTransform3D(____)
[____] = estimateGeometricTransform3D(____, Name,Value)
```

Description

`tform = estimateGeometricTransform3D(matchedPoints1,matchedPoints2, transformType)` estimates a 3-D geometric transformation between two sets of 3-D points by mapping the inliers in the matched points from one set of 3-D points `matchedPoints1` to the inliers in the matched points from the other set of 3-D points `matchedPoints2`.

`[tform,inlierIndex] = estimateGeometricTransform3D(____)` additionally returns a vector specifying each matched point pair as either an inlier or an outlier using the input arguments from the previous syntax.

`[tform,inlierIndex,status] = estimateGeometricTransform3D(____)` additionally returns a status code indicating whether or not the function could estimate a transformation and, if not, why it failed. If you do not specify the `status` output, the function instead returns an error for conditions that cannot produce results.

`[____] = estimateGeometricTransform3D(____, Name,Value)` specifies additional options using one or more name-value pair arguments in addition to any combination of arguments from previous syntaxes. For example, `'Confidence',99` sets the confidence value for finding the maximum number of inliers to 99.

Examples

Estimate Transformation Between Two Point Clouds

Load a point cloud file into the workspace.

```
ptCloud1 = pcread('teapot.ply')
```

```
ptCloud1 =
    pointCloud with properties:
```

```
    Location: [41472x3 single]
    Count: 41472
    XLimits: [-3 3.4340]
    YLimits: [-2 2]
    ZLimits: [0 3.1500]
    Color: []
```

```
Normal: []  
Intensity: []
```

```
ptCloud1 = pcdsample(ptCloud1, 'random', 0.25);
```

Create a rigid 3-D transformation object with a 30-degree rotation.

```
theta = 30; % degrees  
rot = [cosd(theta) sind(theta) 0; ...  
      -sind(theta) cosd(theta) 0; ...  
       0 0 1];  
trans = [0 0 0];  
tform = rigid3d(rot, trans);
```

Transform the point cloud using the transformation object.

```
ptCloud2 = pctransform(ptCloud1, tform);
```

To introduce noise, add random points to both point clouds.

```
noise1 = rescale(rand(1000, 3), -2, 2);  
ptCloud1 = pointCloud([ptCloud1.Location; noise1]);  
noise2 = rescale(rand(1000, 3), -2, 2);  
ptCloud2 = pointCloud([ptCloud2.Location; noise2]);
```

Visualize the noisy point clouds.

```
figure  
pcshowpair(ptCloud1, ptCloud2)  
title('Point Clouds With Added Noise')
```

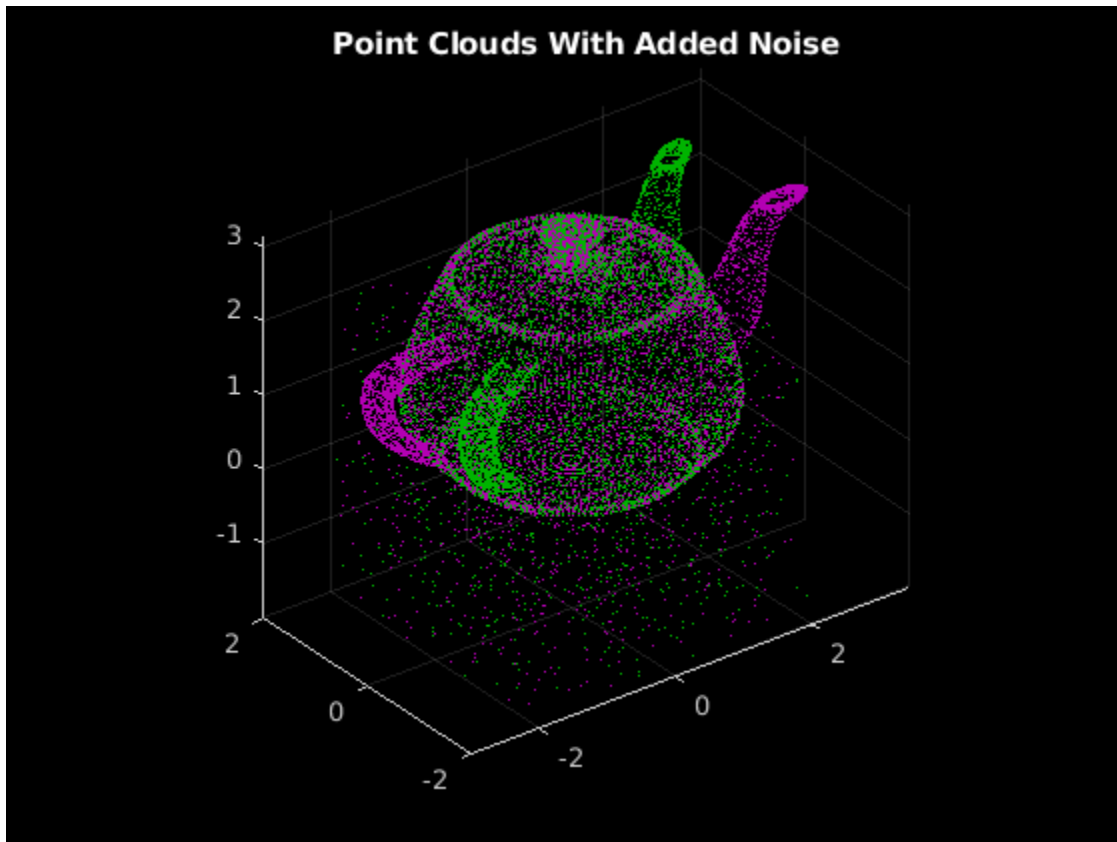

Extract matched points from the point clouds.

```
matchedPoints1 = ptCloud1.Location;
matchedPoints2 = ptCloud2.Location;
```

Estimate the rigid transformation between the point clouds.

```
[tformEst,inlierIndex] = estimateGeometricTransform3D(matchedPoints1, ...
    matchedPoints2,'rigid');
```

Extract the inlier points.

```
inliersPtCloud1 = transformPointsForward(tformEst,matchedPoints1(inlierIndex,:));
inliersPtCloud2 = matchedPoints2(inlierIndex,:);
```

Visualize the inliers of the aligned point clouds.

```
figure
firstPtCloud = pointCloud(inliersPtCloud1);
secondPtCloud = pointCloud(inliersPtCloud2);
pcshowpair(firstPtCloud,secondPtCloud)
title('Aligned point clouds')
```

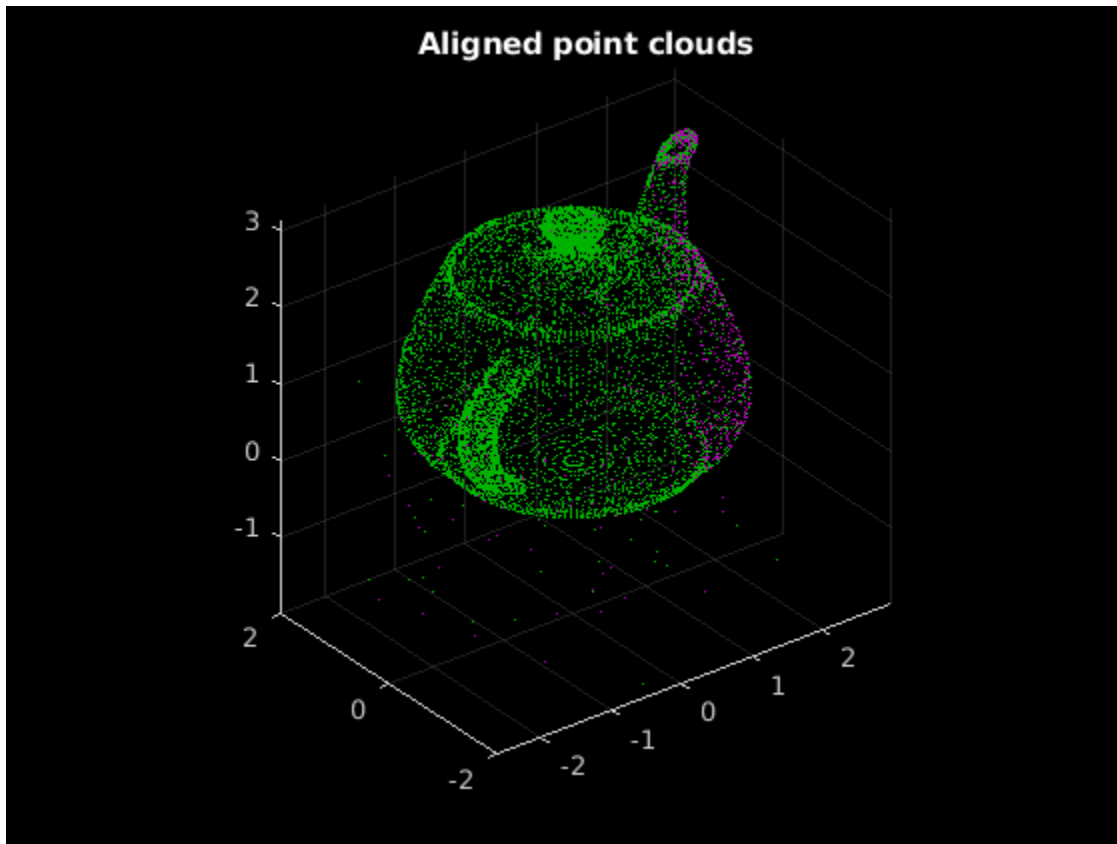

Input Arguments

matchedPoints1 — First set of matched 3-D points

M-by-3 matrix of $[x,y,z]$ coordinates

First set of matched 3-D points, specified as an *M*-by-3 matrix in which each row is a set of (x,y,z) coordinates and *M* is the number of matched points.

matchedPoints2 — Second set of atched 3-D points

M-by-3 matrix of $[x,y,z]$ coordinates

Second set of matched 3-D points, specified as an *M*-by-3 matrix in which each row is a set of (x,y,z) coordinates and *M* is the number of matched points.

transformType — Transformation type

'rigid' | 'similarity'

Transformation type, specified as 'rigid' or 'similarity'. Each transform type requires a minimum number of matched pairs of points to estimate a transformation. You can generally improve the accuracy of a transformation by using a larger number of matched pairs of points. This table shows the type of object associated with each transformation type and the minimum number of matched pairs of points the transformation requires.

transformType	tform Object	Minimum Number of Matched Pairs of Points
'rigid'	rigid3d	3
'similarity'	affine3d	3

Data Types: string

Name-Value Pair Arguments

Specify optional comma-separated pairs of `Name`, `Value` arguments. `Name` is the argument name and `Value` is the corresponding value. `Name` must appear inside quotes. You can specify several name and value pair arguments in any order as `Name1`, `Value1`, ..., `NameN`, `ValueN`.

Example: `'Confidence',99` sets the confidence value for finding the maximum number of inliers to 99.

MaxNumTrials — Maximum random trials

1000 (default) | positive integer

Maximum number of random trials, specified as the comma-separated pair consisting of `'MaxNumTrials'` and a positive integer. This value specifies the number of randomized attempts the function makes to find matching point pairs. Specifying a higher value causes the function to perform additional computations, which increases the likelihood of finding inliers.

Data Types: single | double | int8 | int16 | int32 | int64 | uint8 | uint16 | uint32 | uint64

Confidence — Confidence of finding maximum number of inliers

99 (default) | positive numeric scalar

Confidence of finding the maximum number of inliers, specified as the comma-separated pair consisting of `'Confidence'` and a positive numeric scalar in the range (0, 100). Increasing this value causes the function to perform additional computations, which increases the likelihood of finding a greater number of inliers.

Data Types: single | double | int8 | int16 | int32 | int64 | uint8 | uint16 | uint32 | uint64

MaxDistance — Maximum distance from point to projection

1.5 (default) | positive numeric scalar

Maximum distance from a point to the projection of the corresponding point, specified as the comma-separated pair consisting of `'MaxDistance'` and a positive numeric scalar. `'MaxDistance'` specifies the maximum distance, in pixels, that a point can differ from the projected location of its corresponding point to be considered an inlier. The corresponding projection is based on the estimated transform.

The function checks for a transformation from `matchedPoints1` to `matchedPoints2`, and then calculates the distance between the matched points in each pair after applying the transformation. If the distance between the matched points in a pair is greater than the `'MaxDistance'` value, then the pair is considered an outlier for that transformation. If the distance is less than `'MaxDistance'`, then the pair is considered an inlier.

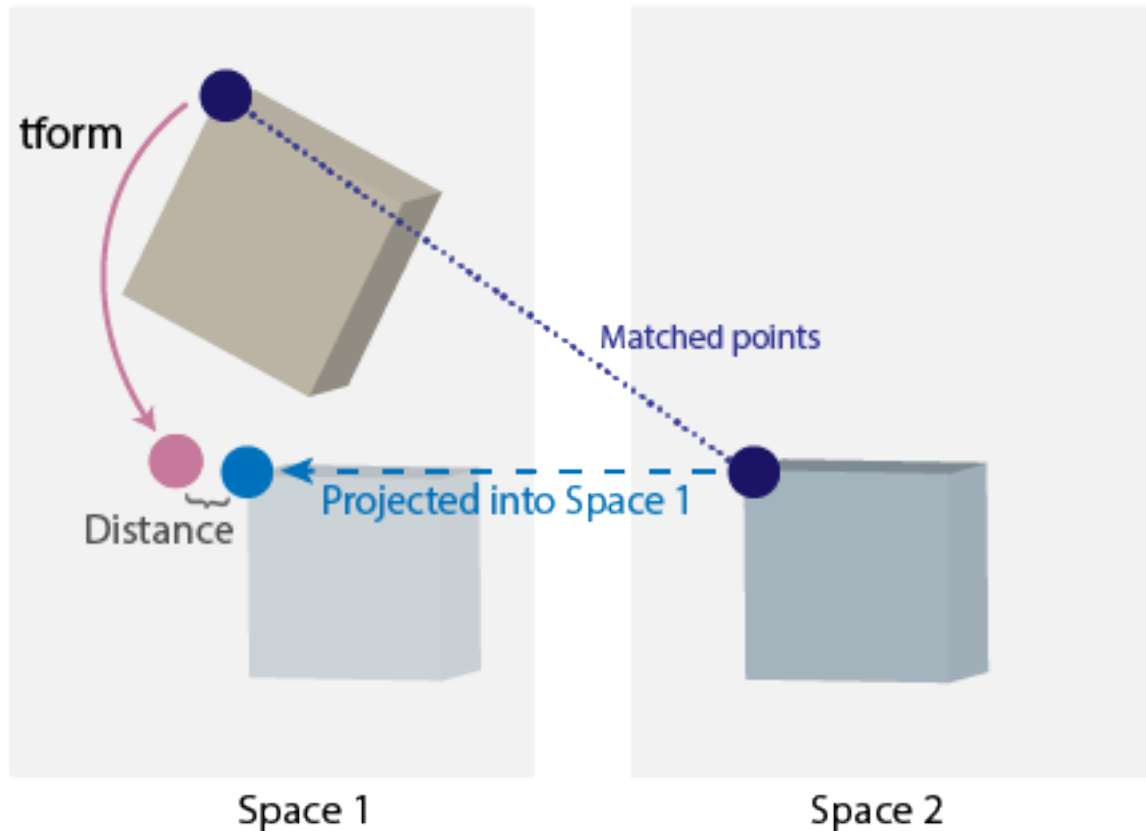

Data Types: `single` | `double` | `int8` | `int16` | `int32` | `int64` | `uint8` | `uint16` | `uint32` | `uint64`

Output Arguments

tform — Geometric transformation

`rigid3d` object | `affine3d` object

Geometric transformation, returned as an `affine3d` or a `rigid3d` object.

The returned geometric transformation matrix maps the inliers in `matchedPoints1` to the inliers in `matchedPoints2`. The function returns an object specific to the transformation type specified by the `transformType` input argument.

transformType	tform
'rigid'	<code>rigid3d</code>
'similarity'	<code>affine3d</code>

status — Status code

0 | 1 | 2

Status code, returned as 0, 1, or 2. The status code indicates whether or not the function could estimate the transformation and, if not, why it failed.

Value	Description
0	No error
1	matchedPoints1 and matchedPoints2 inputs do not contain enough points
2	Not enough inliers found

If you do not specify the `status` code output, the function returns an error if it cannot produce results.

Data Types: `int32`

inlierIndex – Inliers

M-by-1 logical vector

Inliers, returned as an *M*-by-1 logical vector of *M* point pairs. Each element contains either a logical true, 1, to indicate the point pair is an inlier, or a logical false, 0, to indicate the point pair is an outlier.

Algorithms

The function excludes outliers using the M-estimator sample consensus (MSAC) algorithm. The MSAC algorithm is a variant of the random sample consensus (RANSAC) algorithm. Results may not be identical between runs due to the randomized nature of the MSAC algorithm.

References

- [1] Hartley, Richard, and Andrew Zisserman. *Multiple View Geometry in Computer Vision*. 2nd ed. Cambridge, UK; New York: Cambridge University Press, 2003.
- [2] Torr, P.H.S., and A. Zisserman. "MLESAC: A New Robust Estimator with Application to Estimating Image Geometry." *Computer Vision and Image Understanding* 78, no. 1 (April 2000): 138-56. <https://doi.org/10.1006/cviu.1999.0832>.

Extended Capabilities

C/C++ Code Generation

Generate C and C++ code using MATLAB® Coder™.

See Also

Functions

`estimateGeometricTransform2D` | `pregistericp` | `ransac`

Objects

`rigid3d` | `affine3d`

Topics

"Coordinate Systems"

"2-D and 3-D Geometric Transformation Process Overview"

Introduced in R2020b

estimateGeometricTransform

Estimate geometric transform from matching point pairs

Syntax

```
tform = estimateGeometricTransform(matchedPoints1,matchedPoints2,
transformType)
```

```
[tform,inlierpoints1,inlierpoints2] = estimateGeometricTransform(
matchedPoints1,matchedPoints2,transformType)
[ ___,status] = estimateGeometricTransform(matchedPoints1,matchedPoints2,
transformType)
```

```
[ ___ ] = estimateGeometricTransform(matchedPoints1,matchedPoints2,
transformType, Name,Value)
```

Description

`tform = estimateGeometricTransform(matchedPoints1,matchedPoints2, transformType)` returns a 2-D geometric transform object, `tform`. The `tform` object maps the inliers in `matchedPoints1` to the inliers in `matchedPoints2`.

The function excludes outliers using the M-estimator SAmple Consensus (MSAC) algorithm. The MSAC algorithm is a variant of the Random Sample Consensus (RANSAC) algorithm. Results may not be identical between runs because of the randomized nature of the MSAC algorithm.

Note This function will be removed in a future release. Use the `estimateGeometricTransform2D` or `estimateGeometricTransform3D` function which offer greater functionality.

```
[tform,inlierpoints1,inlierpoints2] = estimateGeometricTransform(
matchedPoints1,matchedPoints2,transformType) returns the corresponding inlier points in
inlierpoints1 and inlierpoints2.
```

```
[ ___,status] = estimateGeometricTransform(matchedPoints1,matchedPoints2,
transformType) returns a status code of 0, 1, or 2. If you do not request the status code output,
the function returns an error for conditions that cannot produce results.
```

```
[ ___ ] = estimateGeometricTransform(matchedPoints1,matchedPoints2,
transformType, Name,Value) uses additional options specified by one or more Name,Value
arguments.
```

Examples

Recover Transformed Image Using SURF Feature Points

Read an image and display it.

```
original = imread('cameraman.tif');  
imshow(original)  
title('Base Image')
```

Base image



Distort and display the transformed image.

```
distorted = imresize(original,0.7);  
distorted = imrotate(distorted,31);  
figure  
imshow(distorted)  
title('Transformed Image')
```

Transformed image

Detect and extract features from the original and the transformed images.

```
ptsOriginal = detectSURFFeatures(original);  
ptsDistorted = detectSURFFeatures(distorted);  
[featuresOriginal,validPtsOriginal] = extractFeatures(original,ptsOriginal);  
[featuresDistorted,validPtsDistorted] = extractFeatures(distorted,ptsDistorted);
```

Match and display features between the images.

```
index_pairs = matchFeatures(featuresOriginal,featuresDistorted);  
matchedPtsOriginal = validPtsOriginal(index_pairs(:,1));  
matchedPtsDistorted = validPtsDistorted(index_pairs(:,2));  
figure  
showMatchedFeatures(original,distorted,matchedPtsOriginal,matchedPtsDistorted)  
title('Matched SURF Points With Outliers');
```

Matched SURF points, including outliers

Exclude the outliers, estimate the transformation matrix, and display the results.

```
[tform,inlierIdx] = estimateGeometricTransform2D(matchedPtsDistorted,matchedPtsOriginal,'similar');
inlierPtsDistorted = matchedPtsDistorted(inlierIdx,:);
inlierPtsOriginal = matchedPtsOriginal(inlierIdx,:);

figure
showMatchedFeatures(original,distorted,inlierPtsOriginal,inlierPtsDistorted)
title('Matched Inlier Points')
```

Matched inlier points

Use the estimated transformation to recover and display the original image from the distorted image.

```
outputView = imref2d(size(original));  
Ir = imwarp(distorted,tform,'OutputView',outputView);  
figure  
imshow(Ir);  
title('Recovered Image');
```

Recovered image

Input Arguments

matchedPoints1 — Matched points from image 1

cornerPoints object | SIFTPoints | SURFPoints object | MSERRegions object | ORBPoints object | BRISKpoints | KAZEPoints | M -by-2 matrix of $[x,y]$ coordinates

Matched points from image 1, specified as either a KAZEPoints, cornerPoints object, SIFTPoints, SURFPoints object, MSERRegions object, ORBPoints object, BRISKPoints or an M -by-2 matrix of $[x,y]$ coordinates. The function excludes outliers using the M-estimator Sample Consensus (MSAC) algorithm. The MSAC algorithm is a variant of the Random Sample Consensus (RANSAC) algorithm.

matchedPoints2 — Matched points from image 2

cornerPoints object | SIFTPoints | SURFPoints object | MSERRegions object | ORBPoints object | BRISKpoints | KAZEPoints | M -by-2 matrix of $[x,y]$ coordinates

Matched points from image 2, specified as either a KAZEPoints, cornerPoints object, SIFTPoints, SURFPoints object, MSERRegions object, ORBPoints object, BRISKPoints or an M -by-2 matrix of $[x,y]$ coordinates. The function excludes outliers using the M-estimator Sample Consensus (MSAC) algorithm. The MSAC algorithm is a variant of the Random Sample Consensus (RANSAC) algorithm.

transformType — Transform type

'similarity' | 'affine' | 'projective'

Transform type, specified as one of three character strings. You can set the transform type to either 'similarity', 'affine', or 'projective'. The greater the number of matched pairs of points, the greater the accuracy of the estimated transformation. The minimum number of matched pairs of points for each transform type:

Transform Type	Minimum Number of Matched Pairs of Points
'similarity'	2
'affine'	3
'projective'	4

Data Types: char

Name-Value Pair Arguments

Specify optional comma-separated pairs of Name, Value arguments. Name is the argument name and Value is the corresponding value. Name must appear inside quotes. You can specify several name and value pair arguments in any order as Name1, Value1, ..., NameN, ValueN.

Example: 'Confidence',99 sets the confidence value to 99.

MaxNumTrials — Maximum random trials

1000 (default) | positive integer

Maximum number of random trials for finding the inliers, specified as the comma-separated pair consisting of 'MaxNumTrials' and a positive integer scalar. Increasing this value improves the robustness of the results at the expense of additional computations.

Data Types: single | double | int8 | int16 | int32 | int64 | uint8 | uint16 | uint32 | uint64

Confidence — Confidence of finding maximum number of inliers

99 (default) | positive numeric scalar

Confidence of finding the maximum number of inliers, specified as the comma-separated pair consisting of 'Confidence' and a percentage numeric scalar in the range (0 100). Increasing this value improves the robustness of the results at the expense of additional computations.

Data Types: single | double | int8 | int16 | int32 | int64 | uint8 | uint16 | uint32 | uint64

MaxDistance — Maximum distance from point to projection

1.5 (default) | positive numeric scalar

Maximum distance in pixels, from a point to the projection of its corresponding point, specified as the comma-separated pair consisting of 'MaxDistance' and a positive numeric scalar. The corresponding projection is based on the estimated transform.

Distance in pixels between the point in image 1 and the projection of the corresponding point from image 2.

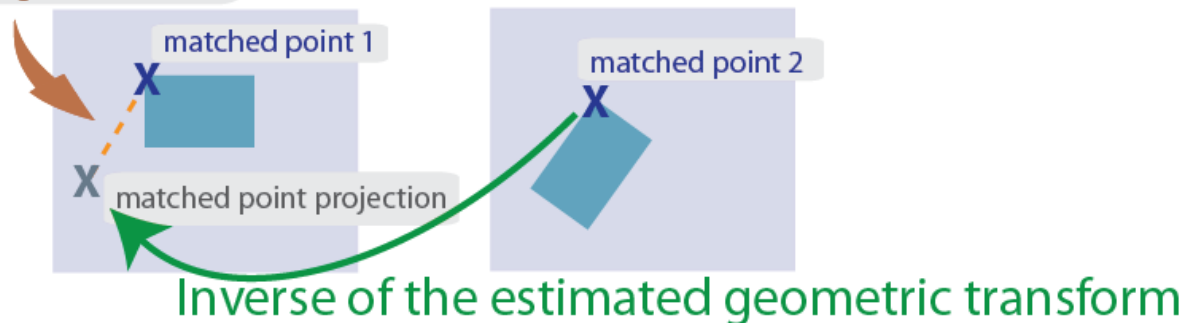

Data Types: single | double | int8 | int16 | int32 | int64 | uint8 | uint16 | uint32 | uint64

Output Arguments**tform — Geometric transformation**

affine2d object | projective2d object

Geometric transformation, returned as either an affine2d object or a projective2d object.

The returned geometric transformation matrix maps the inliers in matchedPoints1 to the inliers in matchedPoints2. When you set the transformType input to either 'similarity' or 'affine', the function returns an affine2d object. Otherwise, it returns a projective2d object.

status — Status code

0 | 1 | 2

Status code, returned as the value 0, 1, or 2.

status	Description
0	No error.

status	Description
1	matchedPoints1 and matchedPoints2 inputs do not contain enough points.
2	Not enough inliers found.

If you do not request the `status` code output, the function will throw an error for the two conditions that cannot produce results.

Data Types: `double`

inlierpoints1 — Inlier points in image 1

`inlier points`

Inlier points in image 1, returned as the same type as the input matching points.

inlierpoints2 — Inlier points in image 2

`inlier points`

Inlier points in image 2, returned as the same type as the input matching points.

References

[1] Hartley, R., and A. Zisserman, "Multiple View Geometry in Computer Vision," *Cambridge University Press*, 2003.

[2] Torr, P. H. S., and A. Zisserman, "MLESAC: A New Robust Estimator with Application to Estimating Image Geometry," *Computer Vision and Image Understanding*, 2000.

Extended Capabilities

C/C++ Code Generation

Generate C and C++ code using MATLAB® Coder™.

Usage notes and limitations:

- You cannot use `SURFPoints` object as an input to `estimateGeometricTransform`. See the "Introduction to Code Generation with Feature Matching and Registration" example for details on how to use `SURFPoints` with `estimateGeometricTransform` in `codegen`.

See Also

Objects

`SIFTPoints` | `KAZEPoints` | `cornerPoints` | `MSERRegions` | `SURFPoints` | `ORBPoints` | `BRISKPoints`

Functions

`fitgeotrans` | `estimateFundamentalMatrix` | `detectSURFFeatures` | `detectMinEigenFeatures` | `detectORBFeatures` | `detectFASTFeatures` | `detectMSERFeatures` | `extractFeatures` | `matchFeatures`

Topics

"Feature Based Panoramic Image Stitching"

"Point Feature Types"

"Coordinate Systems"

"2-D and 3-D Geometric Transformation Process Overview"

"Introduction to Code Generation with Feature Matching and Registration"

Introduced in R2013a

estimateUncalibratedRectification

Uncalibrated stereo rectification

Syntax

```
[T1,T2] = estimateUncalibratedRectification(F,inlierPoints1,inlierPoints2,
imagesize)
```

Description

[T1,T2] = estimateUncalibratedRectification(F,inlierPoints1,inlierPoints2, imagesize) returns projective transformations for rectifying stereo images. This function does not require either intrinsic or extrinsic camera parameters.

Examples

Find Fundamental Matrix Describing Epipolar Geometry

This example shows how to compute the fundamental matrix from corresponding points in a pair of stereo images.

Load the stereo images and feature points which are already matched.

```
I1 = imread('yellowstone_left.png');
I2 = imread('yellowstone_right.png');
load yellowstone_inlier_points;
```

Display point correspondences. Notice that the matching points are in different rows, indicating that the stereo pair is not rectified.

```
showMatchedFeatures(I1, I2,inlier_points1,inlier_points2,'montage');
title('Original images and matching feature points');
```

Original images and matching feature points

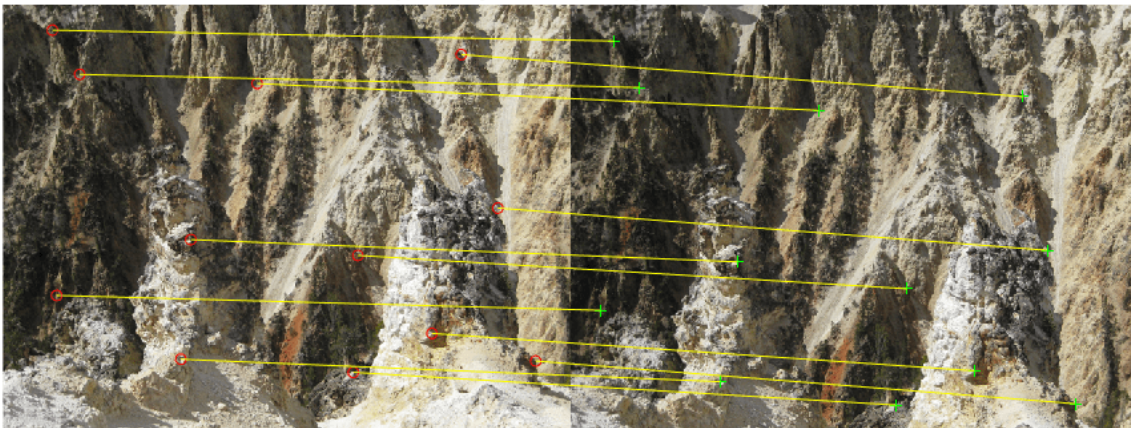

Compute the fundamental matrix from the corresponding points.

```
f = estimateFundamentalMatrix(inlier_points1,inlier_points2,...
    'Method','Norm8Point');
```

Compute the rectification transformations.

```
[t1, t2] = estimateUncalibratedRectification(f,inlier_points1,...
    inlier_points2,size(I2));
```

Rectify the stereo images using projective transformations t1 and t2.

```
[I1Rect,I2Rect] = rectifyStereoImages(I1,I2,t1,t2);
```

Display the stereo anaglyph, which can also be viewed with 3-D glasses.

```
figure;
imshow(stereoAnaglyph(I1Rect,I2Rect));
```



Input Arguments

F — Fundamental matrix for the stereo images

3-by-3 matrix

Fundamental matrix for the stereo images, specified as a 3-by-3 fundamental matrix. The fundamental matrix satisfies the following criteria:

If P_1 , a point in image 1, corresponds to P_2 , a point in image 2, then:

$$[P_2,1] * F * [P_1,1]' = 0$$

F must be double or single.

inlierPoints1 — Coordinates of corresponding points

ORBPoints | BRISKPoints | SIFTPoints | SURFPoints | cornerPoints | MSERRegions | *M*-by-2 matrix of [x,y] coordinates

Coordinates of corresponding points in image one, specified as an *M*-by-2 matrix of *M* number of [x y] coordinates, or as aORBPoints,BRISKPoints , SIFTPoints, SURFPoints, MSERRegions , or cornerPoints object.

inlierPoints2 — Coordinates of corresponding points

ORBPoints | BRISKPoints | SIFTPoints | SURFPoints | cornerPoints | MSERRegions | *M*-by-2 matrix of [x,y] coordinates

Coordinates of corresponding points in image two, specified as an *M*-by-2 matrix of *M* number of [x y] coordinates, or as aORBPoints,BRISKPoints , SIFTPoints, SURFPoints, MSERRegions , or cornerPoints object.

imagesize — Input image size

single | double | integer

Second input image size, specified as a double, single, or integer value and in the format returned by the size function. The size of input image 2 corresponds to inlierPoints2.

Output Arguments

T1 — Projective transformation one

3-by-3 matrix

Projective transformation, returned as a 3-by-3 matrix describing the projective transformations for input image T1.

T2 — Projective transformation two

3-by-3 matrix

Projective transformation, returned as a 3-by-3 matrix describing the projective transformations for input image T2.

Tips

- An epipole may be located in the first image or the second image. Applying the output uncalibrated rectification of T1 (or T2) to image 1 (or image 2) may result in an undesired distortion. You can check for an epipole within an image by applying the isEpipoleInImage function.

References

- [1] Hartley, R. and A. Zisserman. *Multiple View Geometry in Computer Vision*. Cambridge University Press. 2003.

[2] Pollefeys, M., Koch, R., and Van Gool, L.. *A Simple and Efficient Rectification Method for General Motion*. Proceedings of the Seventh IEEE International Conference on Computer Vision. Volume 1, pages 496-501. 1999. DOI:10.1109/ICCV.1999.791262.

Extended Capabilities

C/C++ Code Generation

Generate C and C++ code using MATLAB® Coder™.

See Also

Apps

[Stereo Camera Calibrator](#) | [Camera Calibrator](#)

Objects

[MSERRegions](#) | [SIFTPoints](#) | [SURFPoints](#) | [BRISKPoints](#) | [ORBPoints](#) | [cornerPoints](#) | [cameraParameters](#) | [stereoParameters](#)

Functions

[detectHarrisFeatures](#) | [detectSIFTFeatures](#) | [detectMinEigenFeatures](#) | [detectHarrisFeatures](#) | [estimateFundamentalMatrix](#) | [extractFeatures](#) | [isEpipoleInImage](#) | [matchFeatures](#) | [imwarp](#) | [size](#) | [reconstructScene](#) | [estimateCameraParameters](#) | [cameraMatrix](#) | [undistortImage](#)

Topics

[Uncalibrated Stereo Image Rectification](#)
[“Point Feature Types”](#)
[“Coordinate Systems”](#)

Introduced in R2012b

evaluateDetectionMissRate

Evaluate miss rate metric for object detection

Syntax

```
logAverageMissRate = evaluateDetectionMissRate(detectionResults,
groundTruthData)
[logAverageMissRate,fppi,missRate] = evaluateDetectionMissRate( ___ )
[ ___ ] = evaluateDetectionMissRate( ___ ,threshold)
```

Description

`logAverageMissRate = evaluateDetectionMissRate(detectionResults, groundTruthData)` returns the log-average miss rate of the `detectionResults` compared to `groundTruthData`, which is used to measure the performance of the object detector. For a multiclass detector, the log-average miss rate is a vector of scores for each object class in the order specified by `groundTruthData`.

`[logAverageMissRate,fppi,missRate] = evaluateDetectionMissRate(___)` returns data points for plotting the log miss rate–false positives per image (FPPI) curve, using input arguments from the previous syntax.

`[___] = evaluateDetectionMissRate(___ ,threshold)` specifies the overlap threshold for assigning a detection to a ground truth box.

Examples

Evaluate Miss Rate of a YOLO v2 Object Detector

This example shows how to evaluate miss rate of a pretrained YOLO v2 object detector.

Load the Vehicle Ground Truth Data

Load a table containing the vehicle training data. The first column contains the training images, the remaining columns contain the labeled bounding boxes.

```
data = load('vehicleTrainingData.mat');
trainingData = data.vehicleTrainingData(1:100,:);
```

Add fullpath to the local vehicle data folder.

```
dataDir = fullfile(toolboxdir('vision'), 'visiondata');
trainingData.imageFilename = fullfile(dataDir, trainingData.imageFilename);
```

Create an `imageDatastore` using the files from the table.

```
imds = imageDatastore(trainingData.imageFilename);
```

Create a `boxLabelDatastore` using the label columns from the table.

```
blds = boxLabelDatastore(trainingData(:,2:end));
```

Load YOLOv2 Detector for Detection

Load the detector containing the layerGraph for training.

```
vehicleDetector = load('yolov2VehicleDetector.mat');
detector = vehicleDetector.detector;
```

Evaluate and Plot the Miss Rate Results

Run the detector with imageDatastore.

```
results = detect(detector, imds);
```

Evaluate the results against the ground truth data.

```
[am, fppi, missRate] = evaluateDetectionMissRate(results, blds);
```

Plot the log-miss-rate/FPPI curve.

```
figure;
loglog(fppi, missRate);
grid on
title(sprintf('Log Average Miss Rate = %.1f', am))
```

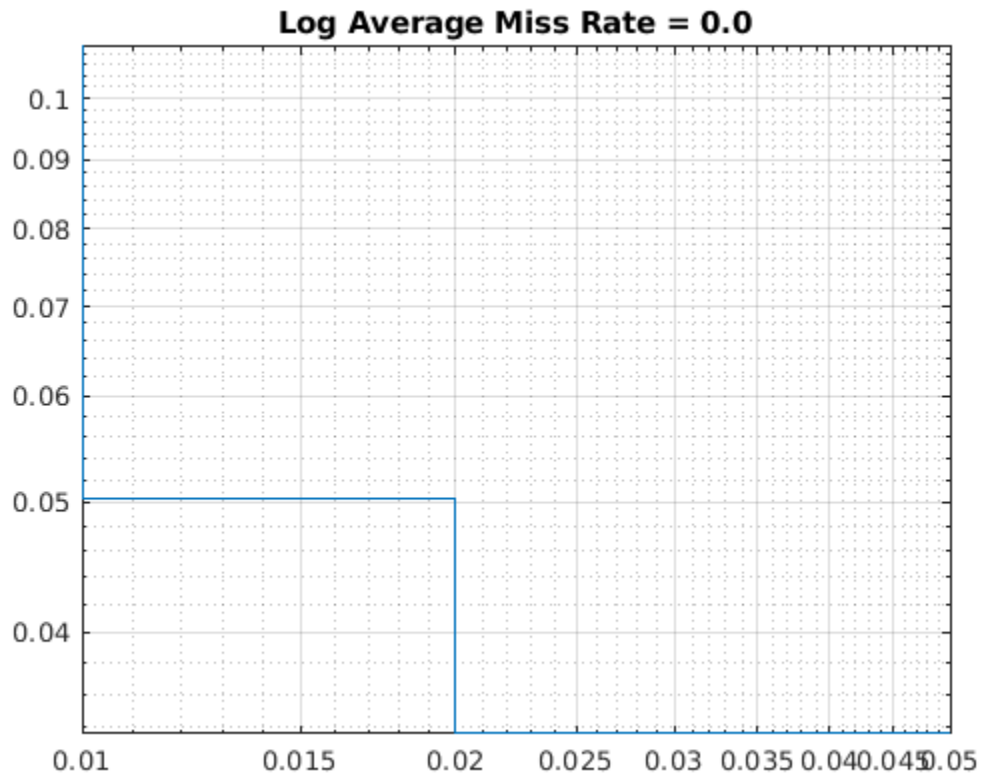

Evaluate a Stop Sign Detector

Load a ground truth table.

```
load('stopSignsAndCars.mat')
stopSigns = stopSignsAndCars(:, 1:2);
stopSigns.imageFilename = fullfile(toolboxdir('vision'),'visiondata', ...
    stopSigns.imageFilename);
```

Train an ACF based detector.

```
detector = trainACFObjectDetector(stopSigns, 'NegativeSamplesFactor', 2);
```

```
ACF Object Detector Training
The training will take 4 stages. The model size is 34x31.
Sample positive examples(~100% Completed)
Compute approximation coefficients...Completed.
Compute aggregated channel features...Completed.
-----
Stage 1:
Sample negative examples(~100% Completed)
Compute aggregated channel features...Completed.
Train classifier with 42 positive examples and 84 negative examples...Completed.
The trained classifier has 19 weak learners.
-----
Stage 2:
Sample negative examples(~100% Completed)
Found 84 new negative examples for training.
Compute aggregated channel features...Completed.
Train classifier with 42 positive examples and 84 negative examples...Completed.
The trained classifier has 20 weak learners.
-----
Stage 3:
Sample negative examples(~100% Completed)
Found 84 new negative examples for training.
Compute aggregated channel features...Completed.
Train classifier with 42 positive examples and 84 negative examples...Completed.
The trained classifier has 54 weak learners.
-----
Stage 4:
Sample negative examples(~100% Completed)
Found 84 new negative examples for training.
Compute aggregated channel features...Completed.
Train classifier with 42 positive examples and 84 negative examples...Completed.
The trained classifier has 61 weak learners.
-----
ACF object detector training is completed. Elapsed time is 23.2991 seconds.
```

Create a struct array to store the results.

```
numImages = height(stopSigns);
results(numImages) = struct('Boxes', [], 'Scores', []);
```

Run the detector on the training images.

```
for i = 1 : numImages
    I = imread(stopSigns.imageFilename{i});
    [bboxes, scores] = detect(detector, I);
    results(i).Boxes = bboxes;
    results(i).Scores = scores;
end
results = struct2table(results);
```

Evaluate the results against the ground truth data.

```
[am, fppi, missRate] = evaluateDetectionMissRate(results, stopSigns(:, 2));
```

Plot log-miss-rate/FPPI curve.

```
figure
loglog(fppi, missRate);
grid on
title(sprintf('log Average Miss Rate = %.1f', am))
```

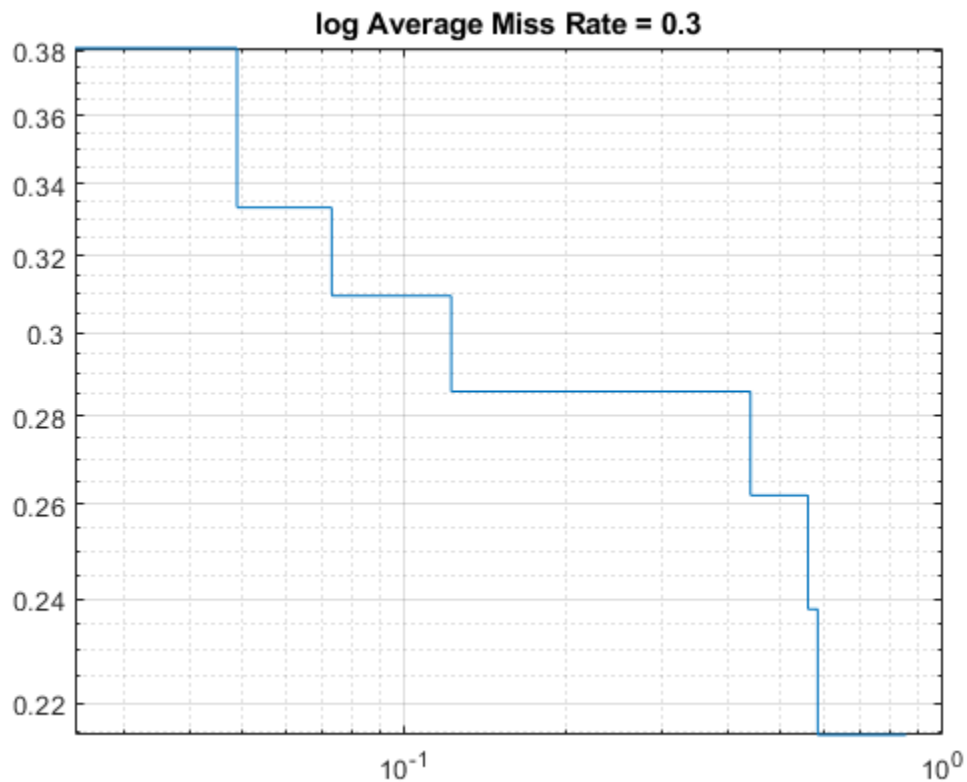

Input Arguments

detectionResults — Object locations and scores

table

Object locations and scores, specified as a two-column table containing the bounding boxes and scores for each detected object. For multiclass detection, a third column contains the predicted label for each detection. The bounding boxes must be stored in an M -by-4 cell array. The scores must be stored in an M -by-1 cell array, and the labels must be stored as a categorical vector.

When detecting objects, you can create the detection results table by using `imageDatastore`.

```
ds = imageDatastore(stopSigns.imageFilename);
detectionResults = detect(detector, ds);
```

Data Types: `table`

groundTruthData — Labeled ground truth

`datastore` | `table`

Labeled ground truth, specified as a datastore or a table.

Each bounding box must be in the format `[x y width height]`.

- **Datastore** — A datastore whose `read` and `readall` functions return a cell array or a table with at least two columns of bounding box and labels cell vectors. The bounding boxes must be in a cell array of M -by-4 matrices in the format `[x,y,width,height]`. The datastore's `read` and `readall` functions must return one of the formats:
 - `{boxes,labels}` — The `boxLabelDatastore` creates this type of datastore.
 - `{images,boxes,labels}` — A combined datastore. For example, using `combine(imds,blds)`.

See `boxLabelDatastore`.

- **Table** — One or more columns. All columns contain bounding boxes. Each column must be a cell vector that contains M -by-4 matrices that represent a single object class, such as `stopSign`, `carRear`, or `carFront`. The columns contain 4-element double arrays of M bounding boxes in the format `[x,y,width,height]`. The format specifies the upper-left corner location and size of the bounding box in the corresponding image.

	1 stopSign	2 carRear	3 carFront
1	6x4 double	4x4 double	7x4 double
2	10x4 double	[561,304,763,194]	8x4 double
3	7x4 double	[733,913,716,32;926,343,203,762]	[513,492,927,625]
4	[428,1007,309,718]	7x4 double	6x4 double
5	3x4 double	4x4 double	5x4 double
6	9x4 double	5x4 double	[111,592,253,922;856,601,892,922]

threshold — Overlap threshold

0.5 | numeric scalar

Overlap threshold for a detection assigned to a ground truth box, specified as a numeric scalar. The overlap ratio is computed as the intersection over union.

Output Arguments

logAverageMissRate — Log-average miss rate metric

numeric scalar | vector

Log-average miss rate metric, returned as either a numeric scalar or vector. For a multiclass detector, the log-average miss rate is returned as a vector of values that correspond to the data points for each class.

fppi — False positives per image

vector of numeric scalars | cell array

False positives per image, returned as either a vector of numeric scalars or as a cell array. For a multiclass detector, the FPPI and log miss rate are cell arrays, where each cell contains the data points for each object class.

missRate — Log miss rate

vector of numeric scalars | cell array

Log miss rate, returned as either a vector of numeric scalars or as a cell array. For a multiclass detector, the FPPI and log miss rate are cell arrays, where each cell contains the data points for each object class.

See Also**Apps**

Video Labeler | Image Labeler

Functions

evaluateDetectionPrecision | trainACFObjectDetector

Objects

boxLabelDatastore | acfObjectDetector

Topics

"Datastores for Deep Learning" (Deep Learning Toolbox)

Introduced in R2017a

evaluateDetectionPrecision

Evaluate precision metric for object detection

Syntax

```
averagePrecision = evaluateDetectionPrecision(detectionResults,
groundTruthData)
[averagePrecision,recall,precision] = evaluateDetectionPrecision( ___ )
[ ___ ] = evaluateDetectionPrecision( ___ ,threshold)
```

Description

`averagePrecision = evaluateDetectionPrecision(detectionResults, groundTruthData)` returns the average precision, of the `detectionResults` compared to the `groundTruthData`. You can use the average precision to measure the performance of an object detector. For a multiclass detector, the function returns `averagePrecision` as a vector of scores for each object class in the order specified by `groundTruthData`.

`[averagePrecision,recall,precision] = evaluateDetectionPrecision(___)` returns data points for plotting the precision-recall curve, using input arguments from the previous syntax.

`[___] = evaluateDetectionPrecision(___ ,threshold)` specifies the overlap threshold for assigning a detection to a ground truth box.

Examples

Evaluate Precision of a YOLO v2 Object Detector

This example shows how to evaluate a pretrained YOLO v2 object detector.

Load the Vehicle Ground Truth Data

Load a table containing the vehicle training data. The first column contains the training images, the remaining columns contain the labeled bounding boxes.

```
data = load('vehicleTrainingData.mat');
trainingData = data.vehicleTrainingData;
```

Add fullpath to the local vehicle data folder.

```
dataDir = fullfile(toolboxdir('vision'), 'visiondata');
trainingData.imageFilename = fullfile(dataDir, trainingData.imageFilename);
```

Create an `imageDatastore` using the files from the table.

```
imds = imageDatastore(trainingData.imageFilename);
```

Create a `boxLabelDatastore` using the label columns from the table.

```
blds = boxLabelDatastore(trainingData(:,2:end));
```

Load YOLOv2 Detector for Detection

Load the detector containing the layerGraph for training.

```
vehicleDetector = load('yolov2VehicleDetector.mat');  
detector = vehicleDetector.detector;
```

Evaluate and Plot the Results

Run the detector with imageDatastore.

```
results = detect(detector, imds);
```

Evaluate the results against the ground truth data.

```
[ap, recall, precision] = evaluateDetectionPrecision(results, blds);
```

Plot the precision/recall curve.

```
figure;  
plot(recall, precision);  
grid on  
title(sprintf('Average precision = %.1f', ap))
```

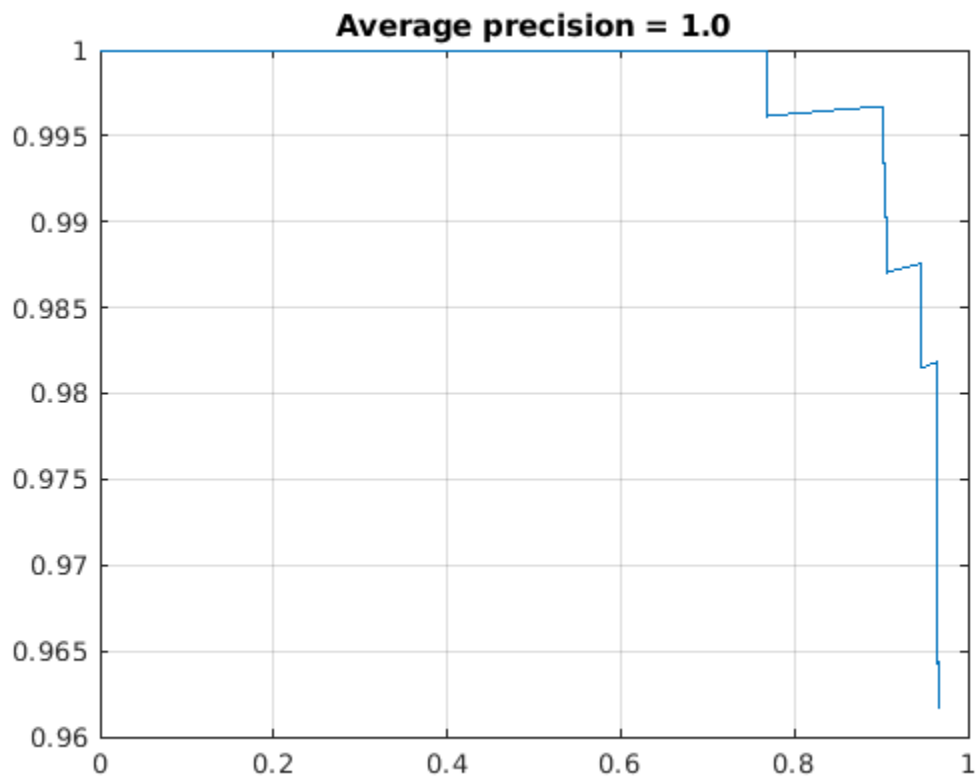

Evaluate Precision of Stop Sign Detector

Train an ACF-based detector using preloaded ground truth information. Run the detector on the training images. Evaluate the detector and display the precision-recall curve.

Load the ground truth table.

```
load('stopSignsAndCars.mat')
stopSigns = stopSignsAndCars(:,1:2);
stopSigns.imageFilename = fullfile(toolboxdir('vision'),'visiondata', ...
    stopSigns.imageFilename);
```

Train an ACF-based detector.

```
detector = trainACFObjectDetector(stopSigns,'NegativeSamplesFactor',2);
```

ACF Object Detector Training

The training will take 4 stages. The model size is 34x31.

Sample positive examples(~100% Completed)

Compute approximation coefficients...Completed.

Compute aggregated channel features...Completed.

Stage 1:

Sample negative examples(~100% Completed)

Compute aggregated channel features...Completed.

Train classifier with 42 positive examples and 84 negative examples...Completed.

The trained classifier has 19 weak learners.

Stage 2:

Sample negative examples(~100% Completed)

Found 84 new negative examples for training.

Compute aggregated channel features...Completed.

Train classifier with 42 positive examples and 84 negative examples...Completed.

The trained classifier has 20 weak learners.

Stage 3:

Sample negative examples(~100% Completed)

Found 84 new negative examples for training.

Compute aggregated channel features...Completed.

Train classifier with 42 positive examples and 84 negative examples...Completed.

The trained classifier has 54 weak learners.

Stage 4:

Sample negative examples(~100% Completed)

Found 84 new negative examples for training.

Compute aggregated channel features...Completed.

Train classifier with 42 positive examples and 84 negative examples...Completed.

The trained classifier has 61 weak learners.

ACF object detector training is completed. Elapsed time is 26.0568 seconds.

Create a table to store the results.

```
numImages = height(stopSigns);
results = table('Size',[numImages 2],...
    'VariableTypes',{'cell','cell'},...
    'VariableNames',{'Boxes','Scores'});
```

Run the detector on the training images. Store the results as a table.

```

for i = 1 : numImages
    I = imread(stopSigns.imageFilename{i});
    [bboxes, scores] = detect(detector,I);
    results.Boxes{i} = bboxes;
    results.Scores{i} = scores;
end

```

Evaluate the results against the ground truth data. Get the precision statistics.

```
[ap,recall,precision] = evaluateDetectionPrecision(results,stopSigns(:,2));
```

Plot the precision-recall curve.

```

figure
plot(recall,precision)
grid on
title(sprintf('Average Precision = %.1f',ap))

```

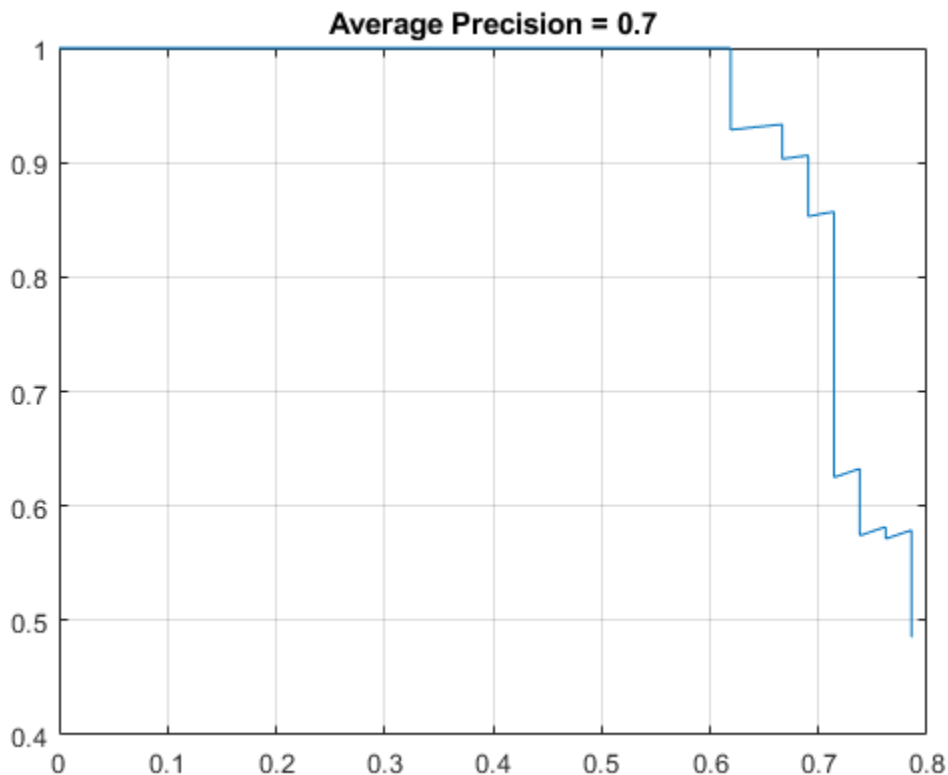

Input Arguments

detectionResults — Object locations and scores

table

Object locations and scores, specified as a two-column table containing the bounding boxes and scores for each detected object. For multiclass detection, a third column contains the predicted label

for each detection. The bounding boxes must be stored in an M -by-4 cell array. The scores must be stored in an M -by-1 cell array, and the labels must be stored as a categorical vector.

When detecting objects, you can create the detection results table by using `imageDatastore`.

```
ds = imageDatastore(stopSigns.imageFilename);
detectionResults = detect(detector,ds);
```

Data Types: table

groundTruthData — Labeled ground truth

datastore | table

Labeled ground truth, specified as a datastore or a table.

Each bounding box must be in the format `[x y width height]`.

- **Datastore** — A datastore whose `read` and `readall` functions return a cell array or a table with at least two columns of bounding box and labels cell vectors. The bounding boxes must be in a cell array of M -by-4 matrices in the format `[x,y,width,height]`. The datastore's `read` and `readall` functions must return one of the formats:
 - `{boxes,labels}` — The `boxLabelDatastore` creates this type of datastore.
 - `{images,boxes,labels}` — A combined datastore. For example, using `combine(imds,blds)`.

See `boxLabelDatastore`.

- **Table** — One or more columns. All columns contain bounding boxes. Each column must be a cell vector that contains M -by-4 matrices that represent a single object class, such as `stopSign`, `carRear`, or `carFront`. The columns contain 4-element double arrays of M bounding boxes in the format `[x,y,width,height]`. The format specifies the upper-left corner location and size of the bounding box in the corresponding image.

	1 stopSign	2 carRear	3 carFront
1	6x4 double	4x4 double	7x4 double
2	10x4 double	[561,304,763,194]	8x4 double
3	7x4 double	[733,913,716,32;926,343,203,762]	[513,492,927,625]
4	[428,1007,309,718]	7x4 double	6x4 double
5	3x4 double	4x4 double	5x4 double
6	9x4 double	6x4 double	6x4 double
7	5x4 double	5x4 double	5x4 double

threshold — Overlap threshold

0.5 (default) | numeric scalar

Overlap threshold for assigned a detection to a ground truth box, specified as a numeric scalar. The overlap ratio is computed as the intersection over union.

Output Arguments

averagePrecision — Average precision

numeric scalar | vector

Average precision over all the detection results, returned as a numeric scalar or vector. Precision is a ratio of true positive instances to all positive instances of objects in the detector, based on the ground

truth. For a multiclass detector, the average precision is a vector of average precision scores for each object class.

recall — Recall values from each detection

vector of numeric scalars | cell array

Recall values from each detection, returned as an M -by-1 vector of numeric scalars or as a cell array. The length of M equals 1 + the number of detections assigned to a class. For example, if your detection results contain 4 detections with class label 'car', then `recall` contains 5 elements. The first value of `recall` is always 0.

Recall is a ratio of true positive instances to the sum of true positives and false negatives in the detector, based on the ground truth. For a multiclass detector, `recall` and `precision` are cell arrays, where each cell contains the data points for each object class.

precision — Precision values from each detection

vector of numeric scalars | cell array

Precision values from each detection, returned as an M -by-1 vector of numeric scalars or as a cell array. The length of M equals 1 + the number of detections assigned to a class. For example, if your detection results contain 4 detections with class label 'car', then `precision` contains 5 elements. The first value of `precision` is always 1.

Precision is a ratio of true positive instances to all positive instances of objects in the detector, based on the ground truth. For a multi-class detector, `recall` and `precision` are cell arrays, where each cell contains the data points for each object class.

See Also

Apps

Video Labeler | **Image Labeler**

Functions

`evaluateDetectionMissRate` | `trainACFObjectDetector`

Objects

`boxLabelDatastore` | `acfObjectDetector`

Topics

“Datastores for Deep Learning” (Deep Learning Toolbox)

Introduced in R2017a

evaluateImageRetrieval

Evaluate image search results

Syntax

```
averagePrecision = evaluateImageRetrieval(queryImage,imageIndex,expectedIDs)
[averagePrecision,imageIDs,scores] = evaluateImageRetrieval(queryImage,
imageIndex,expectedIDs)
[averagePrecision,imageIDs,scores] = evaluateImageRetrieval( ____,Name,Value)
```

Description

`averagePrecision = evaluateImageRetrieval(queryImage,imageIndex,expectedIDs)` returns the average precision metric for measuring the accuracy of image search results for the `queryImage`. The `expectedIDs` input contains the indices of images within `imageIndex` that are known to be similar to the query image.

`[averagePrecision,imageIDs,scores] = evaluateImageRetrieval(queryImage, imageIndex,expectedIDs)` optionally returns the indices corresponding to images within `imageIndex` that are visually similar to the query image. It also returns the corresponding similarity scores.

`[averagePrecision,imageIDs,scores] = evaluateImageRetrieval(____,Name,Value)` uses additional options specified by one or more `Name, Value` pair arguments, using any of the preceding syntaxes.

Examples

Evaluate Image Retrieval Results

Define a set of images.

```
dataDir = fullfile(toolboxdir('vision'),'visiondata','bookCovers');
bookCovers = imageDatastore(dataDir);
```

Display the set of images.

```
thumbnailGallery = [];
for i = 1:length(bookCovers.Files)
    img = readimage(bookCovers,i);
    thumbnail = imresize(img,[300 300]);
    thumbnailGallery = cat(4,thumbnailGallery,thumbnail);
end
figure
montage(thumbnailGallery);
```

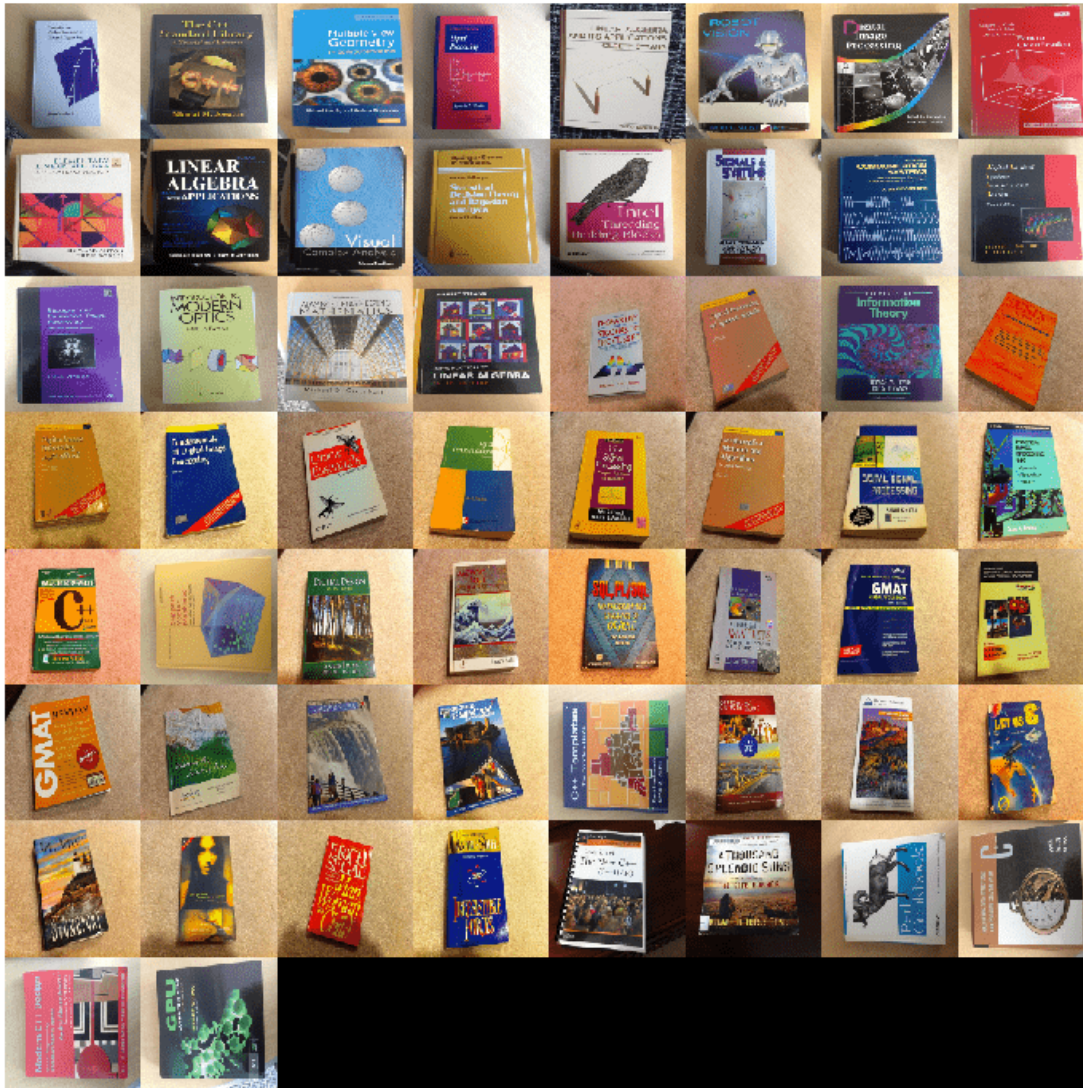

Index the images. This will take a few minutes.

```
imageIndex = indexImages(bookCovers);
```

```
Creating an inverted image index using Bag-Of-Features.
```

```
Creating Bag-Of-Features.
```

- * Selecting feature point locations using the Detector method.
- * Extracting SURF features from the selected feature point locations.
- ** detectSURFFeatures is used to detect key points for feature extraction.

```
* Extracting features from 58 images...done. Extracted 29216 features.
* Keeping 80 percent of the strongest features from each category.
* Balancing the number of features across all image categories to improve clustering.
** Image category 1 has the least number of strongest features: 23373.
** Using the strongest 23373 features from each of the other image categories.

* Creating a 20000 word visual vocabulary.
* Number of levels: 1
* Branching factor: 20000
* Number of clustering steps: 1

* [Step 1/1] Clustering vocabulary level 1.
* Number of features      : 23373
* Number of clusters     : 20000
* Initializing cluster centers...100.00%.
* Clustering...completed 11/100 iterations (~1.19 seconds/iteration)...converged in 11 iterations.

* Finished creating Bag-Of-Features
```

Encoding images using Bag-Of-Features.

```
* Encoding 58 images...done.
Finished creating the image index.
```

Select and display the query image.

```
queryDir = fullfile(dataDir, 'queries', filesep);
query = imread([queryDir 'query2.jpg']);
```

```
figure
imshow(query)
```

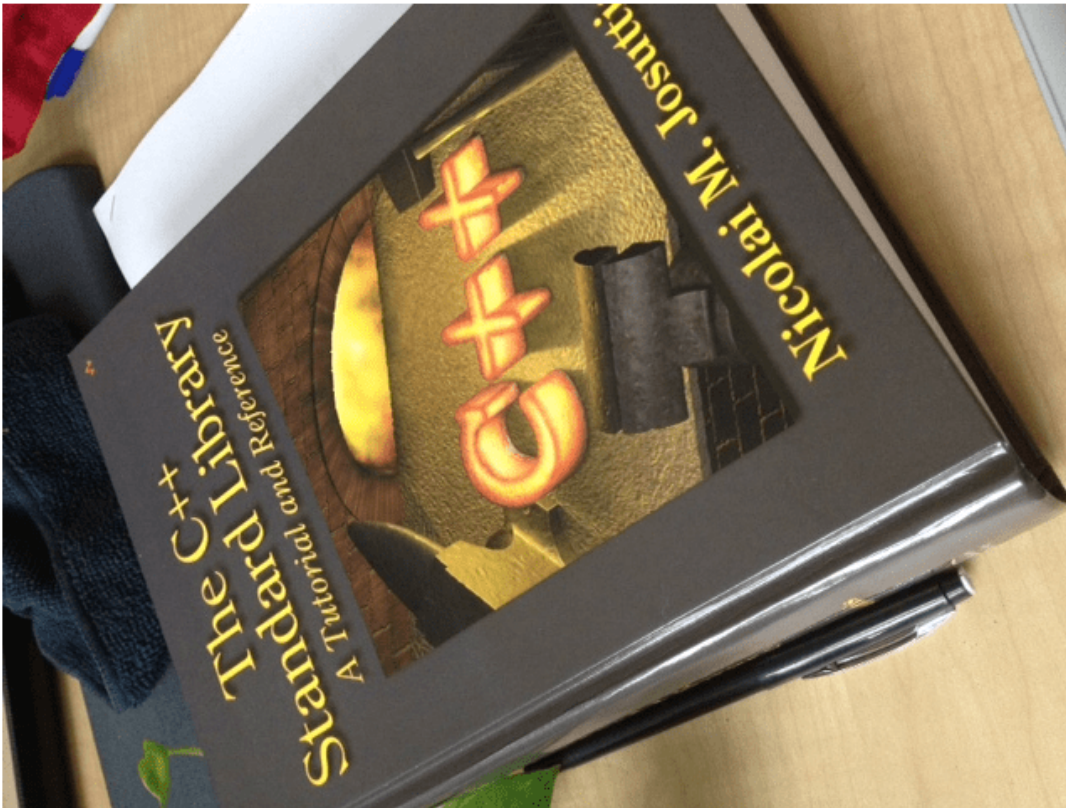

Evaluation requires knowing the expected results. Here, the query image is known to be the 3rd book in the imageIndex.

```
expectedID = 3;
```

Find and report the average precision score.

```
[averagePrecision,actualIDs] = evaluateImageRetrieval(query,...
    imageIndex,expectedID);
```

```
fprintf('Average Precision: %f\n\n',averagePrecision)
```

```
Average Precision: 0.043478
```

Show the query and best match side-by-side.

```
bestMatch = actualIDs(1);
bestImage = imread(imageIndex.ImageLocation{bestMatch});
```

```
figure
imshowpair(query,bestImage,'montage')
```

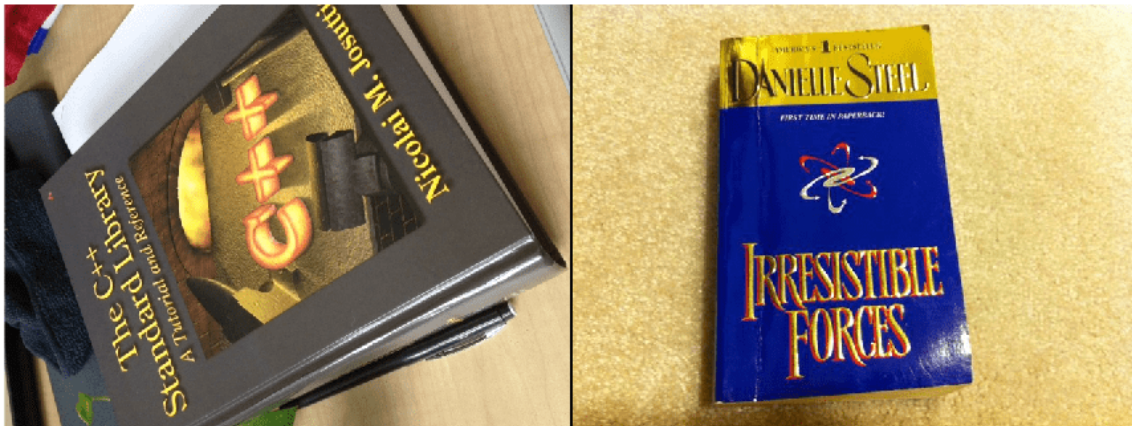
Compute Mean Average Precision (MAP) for Image Retrieval

Create an image set of book covers.

```
dataDir = fullfile(toolboxdir('vision'),'visiondata','bookCovers');
bookCovers = imageDatastore(dataDir);
```

Index the image set. The indexing may take a few minutes.

```
imageIndex = indexImages(bookCovers,'Verbose',false);
```

Create a set of query images.

```
queryDir = fullfile(dataDir,'queries',filesep);
querySet = imageDatastore(queryDir);
```

Specify the expected search results for each query image.

```
expectedIDs = [1 2 3];
```

Evaluate each query image and collect average precision scores.

```
for i = 1:numel(querySet.Files)
    query = readimage(querySet,i);
    averagePrecision(i) = evaluateImageRetrieval(query, imageIndex, expectedIDs(i));
end
```

Compute mean average precision (MAP).

```
map = mean(averagePrecision)
map = 0.8333
```

Input Arguments

queryImage — Input query image

M-by-*N*-by-3 truecolor image | *M*-by-*N* 2-D grayscale image

Input query image, specified as either an *M*-by-*N*-by-3 truecolor image or an *M*-by-*N* 2-D grayscale image.

Data Types: `single` | `double` | `int16` | `uint8` | `uint16` | `logical`

imageIndex — Image search index

`invertedImageIndex` object

Image search index, specified as an `invertedImageIndex` object. The `indexImages` function creates the `invertedImageIndex` object, which stores the data used for the image search.

expectedIDs — Image indices

row or column vector

Image indices, specified as a row or column vector. The indices correspond to the images within `imageIndex` that are known to be similar to the query image.

Name-Value Pair Arguments

Specify optional comma-separated pairs of `Name`, `Value` arguments. `Name` is the argument name and `Value` is the corresponding value. `Name` must appear inside quotes. You can specify several name and value pair arguments in any order as `Name1, Value1, ..., NameN, ValueN`.

Example: `'NumResults',25`

NumResults — Maximum number of search results to evaluate

`Inf` (default) | positive integer value

Maximum number of search results to evaluate, specified as the comma-separated pair consisting of `'NumResults'` and a positive integer value. The function evaluates the top `NumResults` and returns the average-precision-at-`NumResults` metric.

ROI — Rectangular search region

`[1 1 size(queryImage,2) size(queryImage,1)]` (default) | `[x y width height]` vector

Rectangular search region within the query image, specified as the comma-separated pair consisting of `'ROI'` and a `[x y width height]` formatted vector.

Output Arguments

averagePrecision — Average precision metric

scalar value in the range `[0 1]`

Average precision metric, returned as a scalar value in the range `[0 1]`. The average precision metric represents the accuracy of image search results for the query image.

imageIDs — Ranked index of retrieved images

M-by-1 vector

Ranked index of retrieved images, returned as an M -by-1 vector. The image IDs are returned in ranked order, from the most to least similar matched image.

scores — Similarity metric

N -by-1 vector

Similarity metric, returned as an N -by-1 vector. This output contains the scores that correspond to the retrieved images in the `imageIDs` output. The scores are computed using the cosine similarity and range from 0 to 1.

See Also

`retrieveImages` | `indexImages` | `imageDatastore` | `bagOfFeatures` | `invertedImageIndex`

Topics

“Image Retrieval Using Customized Bag of Features”

“Image Retrieval with Bag of Visual Words”

Introduced in R2015a

evaluateSemanticSegmentation

Evaluate semantic segmentation data set against ground truth

Syntax

```
ssm = evaluateSemanticSegmentation(dsResults,dsTruth)
ssm = evaluateSemanticSegmentation(imageSetConfusion,classNames)
[ssm,blockMetrics] = evaluateSemanticSegmentation(blockSetConfusion,
classNames)
[ ___ ] = evaluateSemanticSegmentation( ___ ,Name,Value)
```

Description

`ssm = evaluateSemanticSegmentation(dsResults,dsTruth)` computes various metrics to evaluate the quality of the semantic segmentation results, `dsResults`, against the ground truth segmentation, `dsTruth`.

`ssm = evaluateSemanticSegmentation(imageSetConfusion,classNames)` computes various metrics to evaluate the quality of the semantic segmentation results from confusion matrices, `imageSetConfusion`, with segmentation classes `classNames`.

`[ssm,blockMetrics] = evaluateSemanticSegmentation(blockSetConfusion,classNames)` computes various metrics to evaluate the quality of the block-based semantic segmentation results from confusion matrices, `blockSetConfusion` with classes `classNames`.

`[___] = evaluateSemanticSegmentation(___ ,Name,Value)` computes semantic segmentation metrics using one or more `Name,Value` pair arguments to control the evaluation.

Examples

Evaluate Semantic Segmentation Results

The `triangleImages` data set has 100 test images with ground truth labels. Define the location of the data set.

```
dataSetDir = fullfile(toolboxdir('vision'),'visiondata','triangleImages');
```

Define the location of the test images.

```
testImagesDir = fullfile(dataSetDir,'testImages');
```

Define the location of the ground truth labels.

```
testLabelsDir = fullfile(dataSetDir,'testLabels');
```

Create an `imageDatastore` holding the test images.

```
imds = imageDatastore(testImagesDir);
```

Define the class names and their associated label IDs.

```
classNames = ["triangle","background"];
labelIDs   = [255 0];
```

Create a pixelLabelDatastore holding the ground truth pixel labels for the test images.

```
pxdsTruth = pixelLabelDatastore(testLabelsDir,classNames,labelIDs);
```

Load a semantic segmentation network that has been trained on the training images of triangleImages.

```
net = load('triangleSegmentationNetwork');
net = net.net;
```

Run the network on the test images. Predicted labels are written to disk in a temporary directory and returned as a pixelLabelDatastore.

```
pxdsResults = semanticseg(imds,net,"WriteLocation",tempdir);
```

```
Running semantic segmentation network
```

```
-----
* Processed 100 images.
```

Evaluate the prediction results against the ground truth.

```
metrics = evaluateSemanticSegmentation(pxdsResults,pxdsTruth);
```

```
Evaluating semantic segmentation results
```

```
-----
* Selected metrics: global accuracy, class accuracy, IoU, weighted IoU, BF score.
* Processed 100 images.
* Finalizing... Done.
* Data set metrics:
```

GlobalAccuracy	MeanAccuracy	MeanIoU	WeightedIoU	MeanBFScore
0.90624	0.95085	0.61588	0.87529	0.40652

Display the properties of the semanticSegmentationMetrics object.

```
metrics
```

```
metrics =
  semanticSegmentationMetrics with properties:
```

```
    ConfusionMatrix: [2x2 table]
  NormalizedConfusionMatrix: [2x2 table]
    DataSetMetrics: [1x5 table]
    ClassMetrics: [2x3 table]
    ImageMetrics: [100x5 table]
```

Display the classification accuracy, the intersection over union, and the boundary F-1 score for each class. These values are stored in the ClassMetrics property.

```
metrics.ClassMetrics
```

```
ans=2x3 table
           Accuracy      IoU      MeanBFScore
```

triangle	1	0.33005	0.028664
background	0.9017	0.9017	0.78438

Display the normalized confusion matrix that is stored in the `NormalizedConfusionMatrix` property.

```
metrics.ConfusionMatrix
```

```
ans=2x2 table
```

	triangle	background
triangle	4730	0
background	9601	88069

Input Arguments

dsResults — Predicted pixel labels

datastore | PixelLabelDatastore object | PixelLabelImageDatastore | cell array of datastore objects

Predicted pixel labels resulting from semantic segmentation, specified as a datastore or a cell array of datastore objects. `dsResults` can be any datastore that returns categorical images, such as `PixelLabelDatastore` or `pixelLabelImageDatastore`. The `read(dsResults)` must return a categorical array, a cell array, or a table. If the `read` function returns a multicolumn cell array or table, the second column must contain categorical arrays.

dsTruth — Ground truth pixel labels

PixelLabelDatastore object | cell array of PixelLabelDatastore objects

Ground truth pixel labels, specified as a datastore or a cell array of datastore objects. `dsResults` can be any datastore that returns categorical images, such as `PixelLabelDatastore` or `pixelLabelImageDatastore`. Using `read(dsTruth)` must return a categorical array, a cell array, or a table. If the `read` function returns a multicolumn cell array or table, the second column must contain categorical arrays.

imageSetConfusion — Confusion matrices for segmented images

table | cell array

Confusion matrix for the classes in the segmented images, specified as one of the following, where F is the number of images in the data set.

- Table with F rows and one variable with the name `ConfusionMatrix`. Each row in the table contains a cell array with the confusion matrix for the corresponding image.
- F -by-one cell array. Each element of the cell array contains the confusion matrix for the corresponding image.

blockSetConfusion — Confusion matrices for segmented blocks

table

Confusion matrices for segmented blocks, specified as a table with B rows and three columns, where B is the total number of blocks in all images in the data set. The three columns are the variables `ImageNumber`, `ConfusionMatrix`, and `BlockInfo`. You can obtain a table of the correct format by using the `segmentationConfusionMatrix` function within a call to the block-based `apply` function. For an example, see “Calculate Segmentation Metrics in Block-Based Workflow”.

classNames — Class names

array of strings | cell array of character vectors

Class names, specified as an array of strings or a cell array of character vectors.

Example: ["sky" "grass" "building" "sidewalk"]

Name-Value Pair Arguments

Specify optional comma-separated pairs of `Name`, `Value` arguments. `Name` is the argument name and `Value` is the corresponding value. `Name` must appear inside quotes. You can specify several name and value pair arguments in any order as `Name1, Value1, ..., NameN, ValueN`.

Example: `metrics =`

```
evaluateSemanticSegmentation(pxdsResults, pxdsTruth, 'Metrics', "bfscore")
```

computes only the mean BF score of each class, each image, and the entire data set.

Metrics — Segmentation metrics

"all" (default) | vector of strings

Segmentation metrics in `semanticSegmentationMetrics` to compute, specified as the comma-separated pair consisting of 'Metrics' and a vector of strings. This argument specifies which variables in the `DataSetMetrics`, `ClassMetrics`, and `ImageMetrics` tables to compute. `ConfusionMatrix` and `NormalizedConfusionMatrix` are computed regardless of the value of 'Metric'.

Value	Description	Aggregate Data Set Metric	Image Metric	Class Metric
"all"	Evaluate all semantic segmentation metrics. The function excludes <code>MeanBFScore</code> from the semantic segmentation metrics when you specify a confusion matrix (<code>imageSetConfusion</code> or <code>blockSetConfusion</code>) as input to the function.	All aggregate data set metrics	All image metrics	All class metrics

Value	Description	Aggregate Data Set Metric	Image Metric	Class Metric
"accuracy"	<p>Accuracy indicates the percentage of correctly identified pixels for each class. Use the accuracy metric if you want to know how well each class correctly identifies pixels.</p> <ul style="list-style-type: none"> For each class, Accuracy is the ratio of correctly classified pixels to the total number of pixels in that class, according to the ground truth. In other words, $\text{Accuracy score} = \text{TP} / (\text{TP} + \text{FN})$. TP is the number of true positives and FN is the number of false negatives. For the aggregate data set, MeanAccuracy is the average Accuracy of all classes in all images. For each image, MeanAccuracy is the average Accuracy of all classes in that particular image. <p>The class accuracy is a simple metric analogous to global accuracy, but it can be misleading. For example, labeling all pixels "car" gives a perfect score for the "car" class (although not for the other classes). Use class accuracy in conjunction with IoU for a more complete evaluation of segmentation results.</p>	MeanAccuracy	MeanAccuracy	Accuracy
"bfscore"	<p>The boundary F1 (BF) contour matching score indicates how well the predicted boundary of each class aligns with the true boundary. Use the BF score if you want a metric that tends to correlate better with human qualitative assessment than the IoU metric.</p> <ul style="list-style-type: none"> For each class, MeanBFScore is the average BF score of that class over all images. For each image, MeanBFScore is the average BF score of all classes in that particular image. For the aggregate data set, MeanBFScore is the average BF score of all classes in all images. <p>For more information, see <code>bfscore</code>.</p> <p>This metric is not available when you specify a confusion matrix (<code>imageSetConfusion</code> or <code>blockSetConfusion</code>) as input to the function.</p>	MeanBFScore	MeanBFScore	MeanBFScore
"global-accuracy"	<p>GlobalAccuracy is the ratio of correctly classified pixels, regardless of class, to the total number of pixels. Use the global accuracy metric if you want a quick and computationally inexpensive estimate of the percentage of correctly classified pixels.</p>	GlobalAccuracy	GlobalAccuracy	none

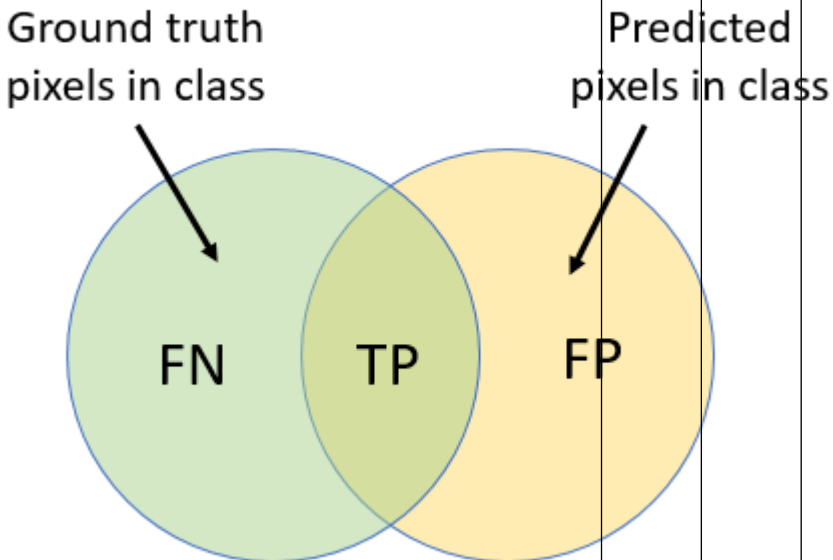
Value	Description	Aggregate Data Set Metric	Image Metric	Class Metric
"iou"	<p>Intersection over union (IoU), also known as the Jaccard similarity coefficient, is the most commonly used metric. Use the IoU metric if you want a statistical accuracy measurement that penalizes false positives.</p> <ul style="list-style-type: none"> For each class, IoU is the ratio of correctly classified pixels to the total number of ground truth and predicted pixels in that class. In other words, $\text{IoU score} = \text{TP} / (\text{TP} + \text{FP} + \text{FN})$ The image describes the true positives (TP), false positives (FP), and false negatives (FN). <div style="text-align: center;">  </div> <ul style="list-style-type: none"> For each image, MeanIoU is the average IoU score of all classes in that particular image. For the aggregate data set, MeanIoU is the average IoU score of all classes in all images. <p>For more information, see <code>jaccard</code>.</p>	MeanIoU	MeanIoU	IoU
"weighted-iou"	<p>Average IoU of each class, weighted by the number of pixels in that class. Use this metric if images have disproportionately sized classes, to reduce the impact of errors in the small classes on the aggregate quality score.</p>	WeightedIoU	WeightedIoU	none

Example: `metrics = evaluateSemanticSegmentation(pxdsResults, pxdsTruth, 'Metrics', ["global-accuracy", "iou"])` calculates the global accuracy and IoU metrics across the data set, images, and classes.

Data Types: `string`

Verbose — Flag to display evaluation progress

1 (default) | 0

Flag to display evaluation progress information in the command window, specified as the comma-separated pair consisting of 'Verbose' and either 1 (true) or 0 (false).

The displayed information includes a progress bar, elapsed time, estimated time remaining, and data set metrics.

Example: `metrics = evaluateSemanticSegmentation(pxdsResults, pxdsTruth, 'Verbose', 0)` calculates segmentation metrics without displaying progress information.

Data Types: `logical`

Output Arguments

ssm — Semantic segmentation metrics

`semanticSegmentationMetrics` object

Semantic segmentation metrics, returned as a `semanticSegmentationMetrics` object.

blockMetrics — Block-based semantic segmentation metrics

F -by-one cell array

Block-based semantic segmentation metrics, returned as an F -by-one cell array, where F is the number of images in the data set. Each element in the cell array contains information about all of the metrics calculated for all blocks in the corresponding image, formatted as a table.

Each table has $K(f)$ rows, where $K(f)$ is the number of blocks in the f th image in the data set. The table has up to five variables:

- The table always includes the `BlockInfo` variable. This table data in this variable are structs that provide spatial information about the block. The four fields of the struct are `BlockStartWorld`, `BlockEndWorld`, `DataStartWorld`, and `DataEndWorld`. For more information about these fields, see the `IncludeBlockInfo` name-value pair argument of the `apply` function.
- The table includes the metrics in the `DataSetMetrics` property of the `ssm` output argument. By default, the metrics are `GlobalAccuracy`, `MeanAccuracy`, `MeanIoU`, and `WeightedIoU`. However, if you create the `ssm` and specify a subset of the metrics to calculate by using the `Metrics` name-value pair argument, then the table includes only the specified metrics.

References

- [1] Csurka, G., D. Larlus, and F. Perronnin. "What is a good evaluation measure for semantic segmentation?" *Proceedings of the British Machine Vision Conference*, 2013, pp. 32.1–32.11.

Extended Capabilities

Automatic Parallel Support

Accelerate code by automatically running computation in parallel using Parallel Computing Toolbox™.

- To run in parallel, set 'UseParallel' to true or enable this by default using the Computer Vision Toolbox preferences.

For more information, see “Parallel Computing Toolbox Support”.

- Parallel processing is only supported when the input datastore is a `pixelLabelDatastore` or a `pixelLabelImageDatastore`.

See Also

Functions

`semanticseg` | `plotconfusion` | `jaccard` | `bfscore` | `segmentationConfusionMatrix`

Objects

`semanticSegmentationMetrics` | `PixelLabelDatastore` | `pixelLabelImageDatastore`

Topics

“Calculate Segmentation Metrics in Block-Based Workflow”

“Getting Started with Semantic Segmentation Using Deep Learning”

“Deep Learning in MATLAB” (Deep Learning Toolbox)

“Datastores for Deep Learning” (Deep Learning Toolbox)

Introduced in R2017b

extractFeatures

Extract interest point descriptors

Syntax

```
[features,validPoints] = extractFeatures(I,points)
[features,validPoints] = extractFeatures(I,points,Name,Value)
```

Description

[features,validPoints] = extractFeatures(I,points) returns extracted feature vectors, also known as descriptors, and their corresponding locations, from a binary or intensity image.

The function derives the descriptors from pixels surrounding an interest point. The pixels represent and match features specified by a single-point location. Each single-point specifies the center location of a neighborhood. The method you use for descriptor extraction depends on the class of the input points.

[features,validPoints] = extractFeatures(I,points,Name,Value) uses additional options specified by one or more Name,Value pair arguments.

Examples

Extract Corner Features from an Image.

Read the image.

```
I = imread('cameraman.tif');
```

Find and extract corner features.

```
corners = detectHarrisFeatures(I);
[features, valid_corners] = extractFeatures(I, corners);
```

Display image.

```
figure; imshow(I); hold on
```



Plot valid corner points.

```
plot(valid_corners);
```



Extract SURF Features from an Image**Read image.**

```
I = imread('cameraman.tif');
```

Find and extract features.

```
points = detectSURFFeatures(I);
[features, valid_points] = extractFeatures(I, points);
```

Display and plot ten strongest SURF features.

```
figure; imshow(I); hold on;
plot(valid_points.selectStrongest(10), 'showOrientation', true);
```

**Extract MSER Features from an Image****Read image.**

```
I = imread('cameraman.tif');
```

Find features using MSER with SURF feature descriptor.

```
regions = detectMSERFeatures(I);
[features, valid_points] = extractFeatures(I, regions, 'Upright', true);
```

Display SURF features corresponding to the MSER ellipse centers.

```
figure; imshow(I); hold on;
plot(valid_points, 'showOrientation', true);
```



Input Arguments

I — Input image

binary image | M -by- N 2-D grayscale image

Input image, specified as either a binary or 2-D grayscale image.

Data Types: `logical` | `single` | `double` | `int16` | `uint8` | `uint16`

points — Center location point

`SIFTPoints` | `BRISKPoints` object | `cornerPoints` object | `SURFPoints` object | `KAZEPoints` object | `MSERRegions` object | `ORBPoints` object | M -by-2 matrix of $[x,y]$ coordinates

Center location point of a square neighborhood, specified as either a `SIFTPoints`, `BRISKPoints`, `SURFPoints`, `KAZEPoints`, `MSERRegions`, `cornerPoints`, or `ORBPoints` object, or an M -by-2 matrix of M number of $[x y]$ coordinates. The table lists the possible input classes of points that can be used for extraction.

Class of Points	
<code>SIFTPoints</code>	Scale-Invariant Feature Transform (SIFT)
<code>BRISKPoints</code>	Binary Robust Invariant Scalable Keypoints (BRISK)
<code>SURFPoints</code> object	Speeded-Up Robust Features (SURF)
<code>MSERRegions</code> object	Maximally Stable Extremal Regions (MSER)
<code>cornerPoints</code>	Features from Accelerated Segment Test (FAST), Minimum eigen-value, or Harris

Class of Points	
KAZEPoints	Non-linear image pyramid-based rotation and orientation invariant features. Similar to SURF, but contains less noisy points.
ORBPoints	Oriented FAST and rotated BRIEF (ORB) features.
M-by-2 matrix of [x y] coordinates	Simple square neighborhood around [x y] point locations

Name-Value Pair Arguments

Specify optional comma-separated pairs of `Name`, `Value` arguments. `Name` is the argument name and `Value` is the corresponding value. `Name` must appear inside quotes. You can specify several name and value pair arguments in any order as `Name1, Value1, . . . , NameN, ValueN`.

Example: `'Method', 'Block'` specifies the `Block` method for descriptor extraction.

Method — Descriptor extraction method

`'Auto'` (default) | `'SIFT'` | `'BRISK'` | `'FREAK'` | `'SURF'` | `'ORB'` | `'KAZE'` | `'Block'`

Descriptor extraction method, specified as `'SIFT'`, `'FREAK'`, `'SURF'`, `'ORB'`, `'Block'`, or `'Auto'`.

The table describes how the function implements the descriptor extraction methods.

Method	Feature Vector (Descriptor)
SIFT	Scale-Invariant Feature Transform (SIFT). The function sets the <code>Orientation</code> property of the <code>validPoints</code> output object to the orientation of the extracted features, in radians.
BRISK	Binary Robust Invariant Scalable Keypoints (BRISK). The function sets the <code>Orientation</code> property of the <code>validPoints</code> output object to the orientation of the extracted features, in radians.
FREAK	Fast Retina Keypoint (FREAK). The function sets the <code>Orientation</code> property of the <code>validPoints</code> output object to the orientation of the extracted features, in radians.
SURF	Speeded-Up Robust Features (SURF). The function sets the <code>Orientation</code> property of the <code>validPoints</code> output object to the orientation of the extracted features, in radians. When you use an <code>MSERRegions</code> object with the SURF method, the <code>Centroid</code> property of the object extracts SURF descriptors. The <code>Axes</code> property of the object selects the scale of the SURF descriptors such that the circle representing the feature has an area proportional to the MSER ellipse area. The scale is calculated as $1/4 * \sqrt{(\text{majorAxes}/2) * (\text{minorAxes}/2)}$ and saturated to 1.6, as required by the <code>SURFPoints</code> object.
ORB	Oriented FAST and rotated BRIEF (ORB) features. The <code>Orientation</code> property of the <code>validPoints</code> output object is automatically set to the <code>Orientation</code> property of the input <code>ORBPoints</code> object points.

Method	Feature Vector (Descriptor)
KAZE	<p>Non-linear pyramid-based features.</p> <p>The function sets the <code>Orientation</code> property of the <code>validPoints</code> output object to the orientation of the extracted features, in radians.</p> <p>When you use an <code>MSERRegions</code> object with the KAZE method, the <code>Location</code> property of the object is used to extract KAZE descriptors.</p> <p>The <code>Axes</code> property of the object selects the scale of the KAZE descriptors such that the circle representing the feature has an area proportional to the MSER ellipse area.</p>
Block	<p>Simple square neighborhood.</p> <p>The <code>Block</code> method extracts only the neighborhoods fully contained within the image boundary. Therefore, the output, <code>validPoints</code>, can contain fewer points than the input <code>POINTS</code>.</p>
Auto	<p>The function selects the <code>Method</code>, based on the class of the input points and implements:</p> <ul style="list-style-type: none"> The <code>FREAK</code> method for a <code>cornerPoints</code> input object. The <code>SURF</code> method for a <code>SURFPoints</code> or <code>MSERRegions</code> input object. The <code>BRISK</code> method for a <code>BRISKPoints</code> input object. The <code>ORB</code> method for a <code>ORBPoints</code> input object. <p>For an M-by-2 input matrix of $[x\ y]$ coordinates, the function implements the <code>Block</code> method.</p>

Note The descriptor extraction method must be `ORB`, if the input `points` is an `ORBPoints` object. Also, `ORB` descriptor extraction method is not supported for any other class of points, except `ORBPoints`.

BlockSize – Block size

11 (default) | odd integer scalar

Block size, specified as an odd integer scalar. This value defines the local square neighborhood **BlockSize**-by-**BlockSize**, centered at each interest point. This option applies only when the function implements the `Block` method.

Upright – Rotation invariance flag

false | logical scalar

Rotation invariance flag, specified a logical scalar. When you set this property to `true`, the orientation of the feature vectors are not estimated and the feature orientation is set to $\pi/2$. Set this to `true` when you do not need the image descriptors to capture rotation information. When you set this property to `false`, the orientation of the features is estimated and the features are then invariant to rotation.

Note The rotation invariance flag '`Upright`' is not supported if the input `points` is an `ORBPoints` object.

FeatureSize — Length of feature vector

64 (default) | 128

Length of the SURF or KAZE feature vector (descriptor), specified as 64 or 128. This option applies only when the function implements the SURF or KAZE method. The larger feature size of 128 provides greater accuracy, but decreases the feature matching speed.

Output Arguments**features — Feature vectors** M -by- N matrix | `binaryFeatures` object

Feature vectors, returned as a `binaryFeatures` object or an M -by- N matrix of M feature vectors, also known as descriptors. Each descriptor is of length N .

validPoints — Valid points

`SIFTPoints``BRISKPoints` object | `cornerPoints` object | `SURFPoints` object | `KAZEPoints` object | `MSERRegions` object | `ORBPoints` object | M -by-2 matrix of $[x,y]$ coordinates

Valid points associated with each output feature vector (descriptor) in `features`, returned in the same format as the input. Valid points can be a `SIFTPoints`, `BRISKPoints`, `cornerPoints`, `SURFPoints`, `KAZEPoints`, `MSERRegions`, `ORBPoints` object, or an M -by-2 matrix of $[x,y]$ coordinates.

The function extracts descriptors from a region around each interest point. If the region lies outside of the image, the function cannot compute a feature descriptor for that point. When the point of interest lies too close to the edge of the image, the function cannot compute the feature descriptor. In this case, the function ignores the point. The point is not included in the valid points output.

References

- [1] G. Bradski and A. Kaehler, *Learning OpenCV : Computer Vision with the OpenCV Library*, O'Reilly, Sebastopol, CA, 2008.
- [2] Herbert Bay, Andreas Ess, Tinne Tuytelaars, Luc Van Gool, *SURF: Speeded Up Robust Features*", *Computer Vision and Image Understanding (CVIU)*, Vol. 110, No. 3, pp. 346--359, 2008
- [3] Bay, Herbert, Andreas Ess, Tinne Tuytelaars, and Luc Van Gool, "SURF: Speeded Up Robust Features", *Computer Vision and Image Understanding (CVIU)*, Vol. 110, No. 3, pp. 346--359, 2008.
- [4] Alahi, Alexandre, Ortiz, Raphael, and Pierre Vandergheynst, "FREAK: Fast Retina Keypoint", *IEEE Conference on Computer Vision and Pattern Recognition*, 2012.
- [5] Alcantarilla, P.F., A. Bartoli, and A.J. Davison. "KAZE Features", *ECCV 2012, Part VI, LNCS 7577* pp. 214, 2012

Extended Capabilities**C/C++ Code Generation**

Generate C and C++ code using MATLAB® Coder™.

Usage notes and limitations:

- 'Method' must be a compile-time constant.
- Supports MATLAB Function block for BRISK, FREAK, and SURF methods only.
- Generates portable C code using a C++ compiler that links to OpenCV (Version 4.2.0) libraries for SIFT, BRISK, ORB, FREAK, and SURF Methods. See “Portable C Code Generation for Functions That Use OpenCV Library”.
- The KAZE method and the detectKAZEFeatures function do not support code generation.

See Also

Objects

SURFPoints | ORBPoints | KAZEPoints | MSERRegions | binaryFeatures

Functions

detectSIFTFeatures | detectKAZEFeatures | extractHOGFeatures | extractLBPFeatures | detectBRISKFeatures | detectMSERFeatures | matchFeatures | detectSURFFeatures | detectHarrisFeatures | detectFASTFeatures | detectMinEigenFeatures | detectORBFeatures

Topics

“Point Feature Types”

“Local Feature Detection and Extraction”

Introduced in R2011a

extractHOGFeatures

Extract histogram of oriented gradients (HOG) features

Syntax

```
features = extractHOGFeatures(I)
[features,validPoints] = extractHOGFeatures(I,points)
[ ___, visualization] = extractHOGFeatures(I, ___ )
[ ___ ] = extractHOGFeatures( ___,Name,Value)
```

Description

`features = extractHOGFeatures(I)` returns extracted HOG features from a truecolor or grayscale input image, `I`. The features are returned in a 1-by- N vector, where N is the HOG feature length. The returned features encode local shape information from regions within an image. You can use this information for many tasks including classification, detection, and tracking.

`[features,validPoints] = extractHOGFeatures(I,points)` returns HOG features extracted around specified point locations. The function also returns `validPoints`, which contains the input point locations whose surrounding region is fully contained within `I`. Scale information associated with the points is ignored.

`[___, visualization] = extractHOGFeatures(I, ___)` optionally returns a HOG feature visualization, using any of the preceding syntaxes. You can display this visualization using `plot(visualization)`.

`[___] = extractHOGFeatures(___,Name,Value)` uses additional options specified by one or more `Name,Value` pair arguments, using any of the preceding syntaxes.

Examples

Extract and Plot HOG Features

Read the image of interest.

```
img = imread('cameraman.tif');
```

Extract HOG features.

```
[featureVector,hogVisualization] = extractHOGFeatures(img);
```

Plot HOG features over the original image.

```
figure;
imshow(img);
hold on;
plot(hogVisualization);
```

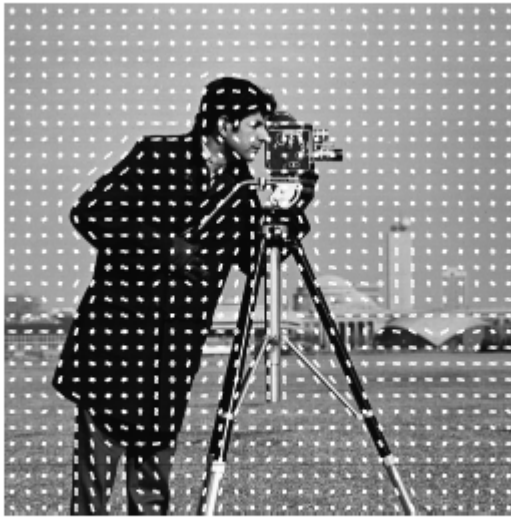

Extract HOG Features using CellSize

Read the image of interest.

```
I1 = imread('gantrycrane.png');
```

Extract HOG features.

```
[hog1,visualization] = extractHOGFeatures(I1,'CellSize',[32 32]);
```

Display the original image and the HOG features.

```
subplot(1,2,1);  
imshow(I1);  
subplot(1,2,2);  
plot(visualization);
```

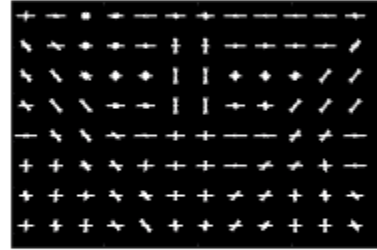

Extract HOG Features Around Corner Points

Read in the image of interest.

```
I2 = imread('gantrycrane.png');
```

Detect and select the strongest corners in the image.

```
corners = detectFASTFeatures(im2gray(I2));
strongest = selectStrongest(corners,3);
```

Extract HOG features.

```
[hog2,validPoints,ptVis] = extractHOGFeatures(I2,strongest);
```

Display the original image with an overlay of HOG features around the strongest corners.

```
figure;
imshow(I2);
hold on;
plot(ptVis,'Color','green');
```

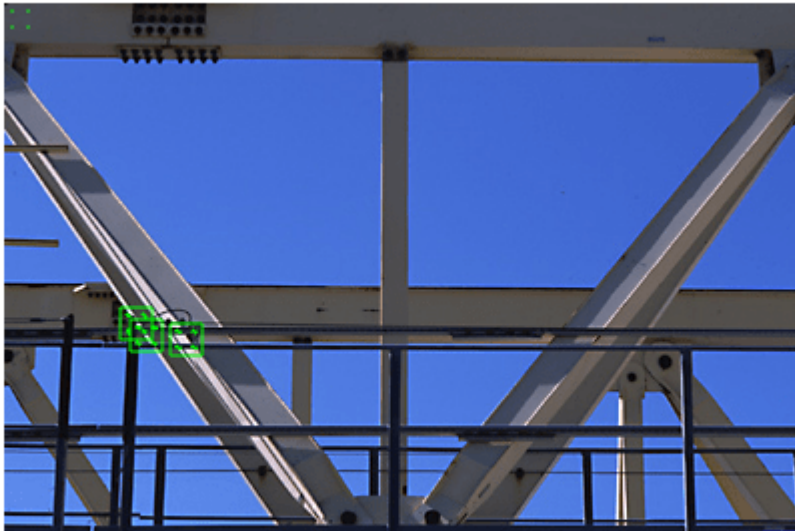

Input Arguments

I — Input image

M-by-*N*-by-3 truecolor image | *M*-by-*N* 2-D grayscale image

Input image, specified in either *M*-by-*N*-by-3 truecolor or *M*-by-*N* 2-D grayscale. The input image must be a real, nonsparse value. If you have tightly cropped images, you may lose shape information that the HOG function can encode. You can avoid losing this information by including an extra margin of pixels around the patch that contains background pixels.

Data Types: `single` | `double` | `int16` | `uint8` | `uint16` | `logical`

points — Center location point

BRISKPoints object | cornerPoints object | SURFPoints object | MSERRegions object | *M*-by-2 matrix of [*x*, *y*] coordinates

Center location point of a square neighborhood, specified as either a BRISKPoints, SURFPoints, MSERRegions, ORBPoints or cornerPoints object, or an *M*-by-2 matrix of *M* number of [*x*, *y*] coordinates. The function extracts descriptors from the neighborhoods that are fully contained within the image boundary. You can set the size of the neighborhood with the `BlockSize` parameter. Only neighborhoods fully contained within the image are used to determine the valid output points. The function ignores scale information associated with these points.

Name-Value Pair Arguments

Specify optional comma-separated pairs of `Name`, `Value` arguments. `Name` is the argument name and `Value` is the corresponding value. `Name` must appear inside quotes. You can specify several name and value pair arguments in any order as `Name1`, `Value1`, ..., `NameN`, `ValueN`.

Example: 'BlockSize',[2 2] sets the BlockSize to be a 2-by-2 square block.

CellSize — Size of HOG cell

[8 8] (default) | 2-element vector

Size of HOG cell, specified in pixels as a 2-element vector. To capture large-scale spatial information, increase the cell size. When you increase the cell size, you may lose small-scale detail.

BlockSize — Number of cells in block

[2 2] (default) | 2-element vector

Number of cells in a block, specified as a 2-element vector. A large block size value reduces the ability to suppress local illumination changes. Because of the number of pixels in a large block, these changes may get lost with averaging. Reducing the block size helps to capture the significance of local pixels. Smaller block size can help suppress illumination changes of HOG features.

BlockOverlap — Number of overlapping cells between adjacent blocks

`ceil(BlockSize/2)` (default)

Number of overlapping cells between adjacent blocks, specified as a 2-element vector. To ensure adequate contrast normalization, select an overlap of at least half the block size. Large overlap values can capture more information, but they produce larger feature vector size. This property applies only when you are extracting HOG features from regions and not from point locations. When you are extracting HOG features around a point location, only one block is used, and thus, no overlap occurs.

NumBins — Number of orientation histogram bins

9 (default) | positive scalar

Number of orientation histogram bins, specified as positive scalar. To encode finer orientation details, increase the number of bins. Increasing this value increases the size of the feature vector, which requires more time to process.

UseSignedOrientation — Selection of orientation values

`false` (default) | logical scalar

Selection of orientation values, specified as a logical scalar. When you set this property to `true`, orientation values are evenly spaced in bins between -180 and 180 degrees. When you set this property to `false`, they are evenly spaced from 0 through 180. In this case, values of theta that are less than 0 are placed into a theta + 180 value bin. Using signed orientation can help differentiate light-to-dark versus dark-to-light transitions within an image region.

Output Arguments

features — Extracted HOG features

1-by-*N* vector | *P*-by-*Q* matrix

Extracted HOG features, returned as either a 1-by-*N* vector or a *P*-by-*Q* matrix. The features encode local shape information from regions or from point locations within an image. You can use this information for many tasks including classification, detection, and tracking.

features output	Description
1-by- N vector	HOG feature length, N , is based on the image size and the function parameter values. $N = \text{prod}([\text{BlocksPerImage}, \text{BlockSize}, \text{NumBins}])$ $\text{BlocksPerImage} = \text{floor}((\text{size}(I)/\text{CellSize} - \text{BlockSize})/(\text{BlockSize} - \text{BlockOverlap}) + 1)$
P -by- Q matrix	P is the number of valid points whose surrounding region is fully contained within the input image. You provide the points input value for extracting point locations. The surrounding region is calculated as: $\text{CellSize} * \text{BlockSize}$. The feature vector length, Q , is calculated as: $\text{prod}([\text{NumBins}, \text{BlockSize}])$.

Example 3.1. Arrangement of Histograms in HOG Feature Vectors

The figure below shows an image with six cells.

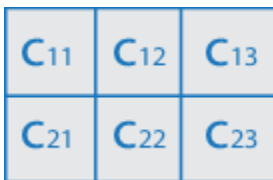

If you set the `BlockSize` to [2 2], it would make the size of each HOG block, 2-by-2 cells. The size of the cells are in pixels. You can set it with the `CellSize` property.



The HOG feature vector is arranged by HOG blocks. The cell histogram, $H(C_{yx})$, is 1-by-`NumBins`.

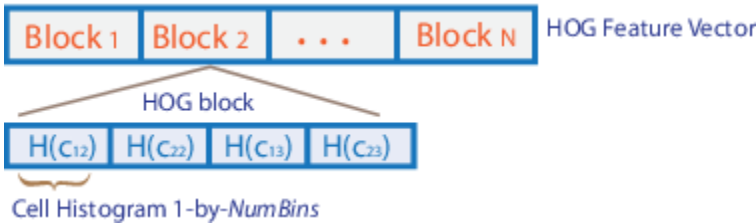

The figure below shows the HOG feature vector with a 1-by-1 cell overlap between blocks.

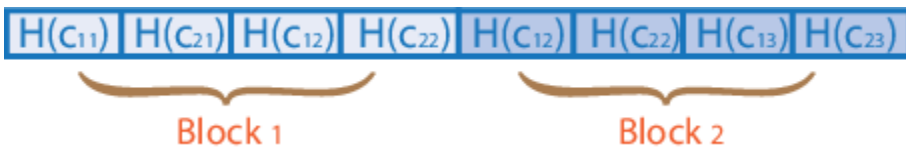

validPoints – Valid points

cornerPoints object | BRISKPoints object | SURFPoints object | MSERRegions object | ORBPoints object | M -by-2 matrix of $[x,y]$ coordinates

Valid points associated with each features descriptor vector output. This output can be returned as either a cornerPoints object, BRISKPoints, SURFPoints object, MSERRegions object, ORBPoints object or an M -by-2 matrix of $[x,y]$ coordinates. The function extracts M number of descriptors from valid interest points in a region of size equal to $[CellSize.*BlockSize]$. The extracted descriptors are returned as the same type of object or matrix as the input. The region must be fully contained within the image.

visualization – HOG feature visualization

object

HOG feature visualization, returned as an object. The function outputs this optional argument to visualize the extracted HOG features. You can use the plot method with the visualization output. See the “Extract and Plot HOG Features” on page 3-587 example.

HOG features are visualized using a grid of uniformly spaced rose plots. The cell size and the size of the image determines the grid dimensions. Each rose plot shows the distribution of gradient orientations within a HOG cell. The length of each petal of the rose plot is scaled to indicate the contribution each orientation makes within the cell histogram. The plot displays the edge directions, which are normal to the gradient directions. Viewing the plot with the edge directions allows you to better understand the shape and contours encoded by HOG. Each rose plot displays two times NumBins petals.







You can use the following syntax to plot the HOG features:

plot(visualization) plots the HOG features as an array of rose plots.

plot(visualization,AX) plots HOG features into the axes AX.

plot(__, 'Color', colorValue) Specifies the color used to plot HOG features, where colorValue represents the color as a 1-by-3 RGB vector, a short, or a long color name, described in the Color Value on page 3-593 table.

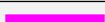
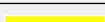
More About**Color Value**

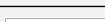
Color Name	Short Name	RGB Triplet	Appearance
'red'	'r'	[1 0 0]	
'green'	'g'	[0 1 0]	
'blue'	'b'	[0 0 1]	
'cyan'	'c'	[0 1 1]	
'magenta'	'm'	[1 0 1]	
'yellow'	'y'	[1 1 0]	
'black'	'k'	[0 0 0]	
'white'	'w'	[1 1 1]	

References

- [1] Dalal, N. and B. Triggs. "Histograms of Oriented Gradients for Human Detection", *IEEE Computer Society Conference on Computer Vision and Pattern Recognition*, Vol. 1 (June 2005), pp. 886-893.

Extended Capabilities

C/C++ Code Generation

Generate C and C++ code using MATLAB® Coder™.

See Also

[extractLBPFeatures](#) | [extractFeatures](#) | [detectMSERFeatures](#) | [matchFeatures](#) | [detectSURFFeatures](#) | [SURFPoints](#) | [MSERRegions](#) | [ORBPoints](#) | [detectORBFeatures](#) | [detectHarrisFeatures](#) | [detectFASTFeatures](#) | [detectMinEigenFeatures](#) | [binaryFeatures](#) | [rose](#)

Topics

"Digit Classification Using HOG Features"

"Local Feature Detection and Extraction"

"Point Feature Types"

Introduced in R2013b

fitPolynomialRANSAC

Fit polynomial to points using RANSAC

Syntax

```
P = fitPolynomialRANSAC(xyPoints,N,maxDistance)
[P,inlierIdx] = fitPolynomialRANSAC( ___ )
[ ___ ] = fitPolynomialRANSAC( ___ ,Name,Value)
```

Description

`P = fitPolynomialRANSAC(xyPoints,N,maxDistance)` finds the polynomial coefficients, `P`, by sampling a small set of points given in `xyPoints` and generating polynomial fits. The fit that has the most inliers within `maxDistance` is returned. If a fit cannot be found, then `P` is returned empty. The function uses the M-estimator sample consensus (MSAC) algorithm, a variation of the random sample consensus (RANSAC) algorithm to fit the data.

`[P,inlierIdx] = fitPolynomialRANSAC(___)` returns a logical array, `inlierIdx`, that specifies the indices for data points that are inliers to the fit polynomial based on `maxDistance`. Use the input arguments from the previous syntax.

`[___] = fitPolynomialRANSAC(___ ,Name,Value)` specifies additional options specified by one or more `Name,Value` pair arguments.

Examples

Fit Parabola to Noisy Data Using RANSAC

Use the RANSAC algorithm to generate a polynomial that fits a set of noisy data. The `fitPolynomialRANSAC` function generates a polynomial by sampling a small set of points from `[x y]` point data and generating polynomial fits. The fit with the most inliers within `maxDistance` is returned.

Construct and plot a parabola with `[x y]` points.

```
x = (-10:0.1:10)';
y = (36-x.^2)/9;
figure
plot(x,y)
title('Parabola')
```

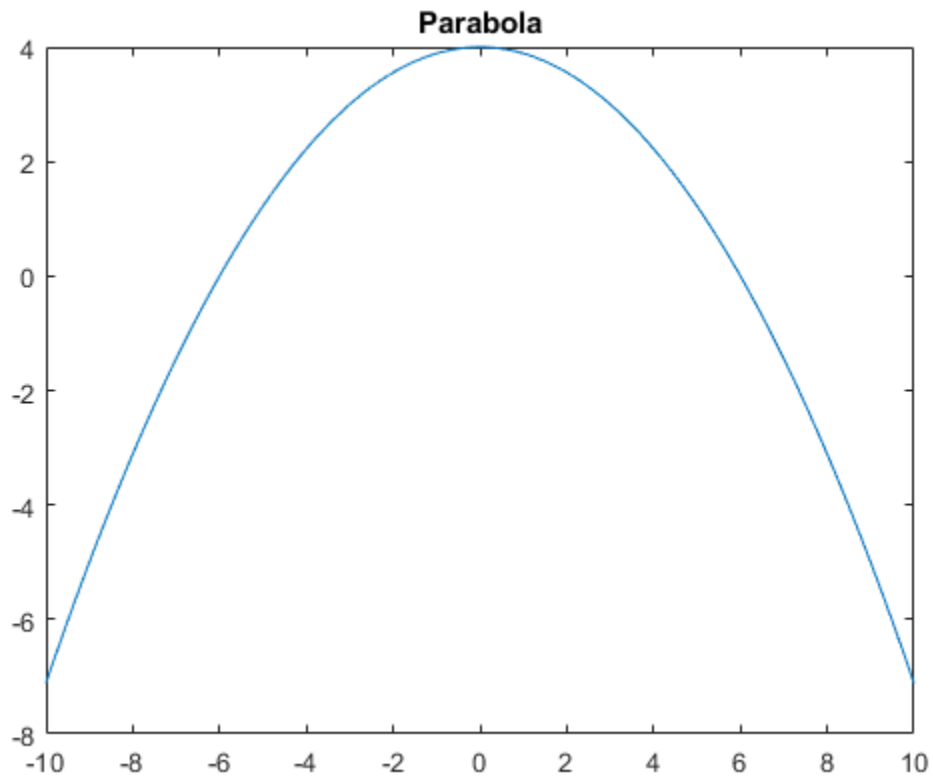

Add noise and outlier points to the points on the parabola.

```
y = y+rand(length(y),1);  
y([50,150,99,199]) = [y(50)+12,y(150)-12,y(99)+33,y(199)-23];  
  
plot(x,y)  
title('Parabola with Outliers and Noise')
```

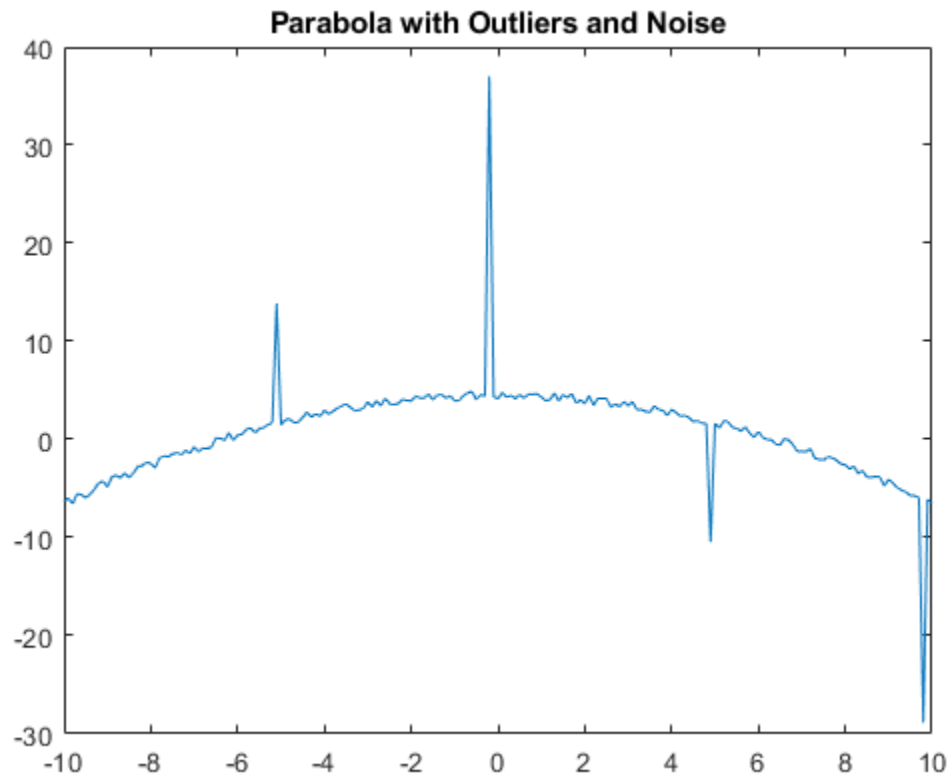

Use `fitPolynomialRANSAC` to generate coefficients for a second-degree polynomial. Also get the inliers identified by the specified `maxDistance` from the polynomial fit.

```
N = 2;           % second-degree polynomial
maxDistance = 1; % maximum allowed distance for a point to be inlier
```

```
[P, inlierIdx] = fitPolynomialRANSAC([x,y],N,maxDistance);
```

Evaluate the polynomial using `polyval`. Plot the curve and overlay the `[x y]` points. Mark outliers with a red circle.

```
yRecoveredCurve = polyval(P,x);
figure
plot(x,yRecoveredCurve,'-g','LineWidth',3)
hold on
plot(x(inlierIdx),y(inlierIdx),'.',x(~inlierIdx),y(~inlierIdx),'ro')
legend('Fit polynomial','Inlier points','Outlier points')
hold off
```

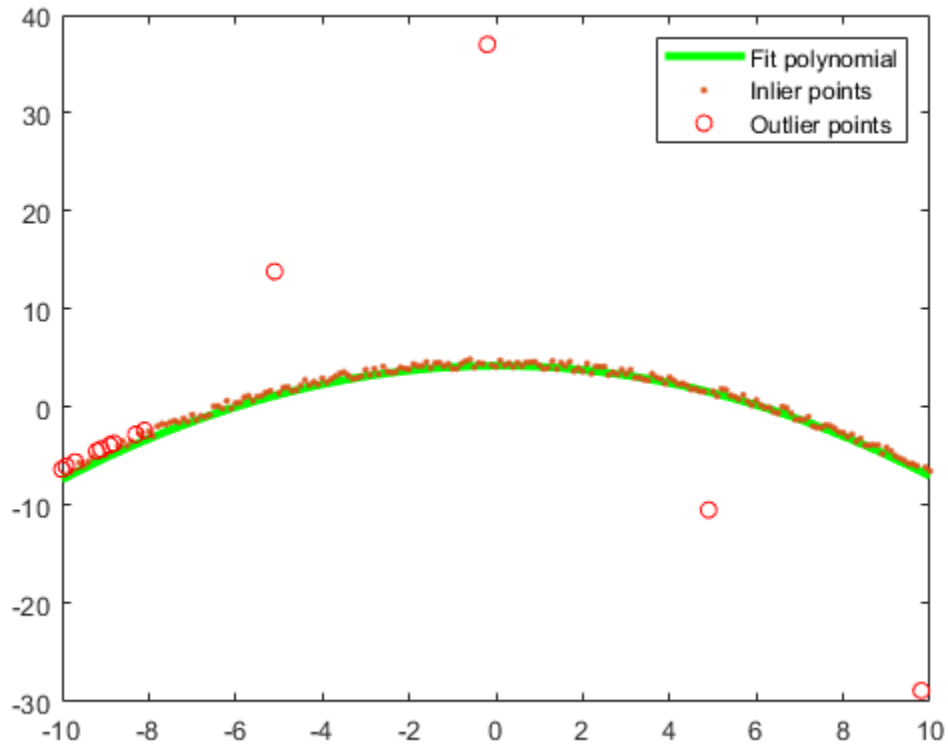

Input Arguments

xyPoints — [x y] coordinate points

m-by-2 matrix

[x y] coordinate points, specified as an *m*-by-2 matrix. The polynomial is fit to these points.

Data Types: double | single | uint32 | int32 | uint16 | int16

N — Degree of polynomial fit

integer

Degree of polynomial fit, *P*, specified as an integer. The degree of a polynomial is the highest degree of the terms in the equation. For example, a polynomial of degree 2 is:

$$Ax^2+Bx+C$$

A, *B*, and *C* are constants. In general, higher degree polynomials allow for a better fit, but the fit depends on your data.

maxDistance — Maximum distance for inlier points

positive scalar

Maximum distance from the polynomial fit curve to an inlier point, specified as a positive scalar. Any points further away are considered outliers. The RANSAC algorithm creates a fit from a small sample

of points but tries to maximize the number of inlier points. Lowering the maximum distance helps to improve the polynomial fit by putting a tighter tolerance on inlier points.

Name-Value Pair Arguments

Specify optional comma-separated pairs of `Name`, `Value` arguments. `Name` is the argument name and `Value` is the corresponding value. `Name` must appear inside quotes. You can specify several name and value pair arguments in any order as `Name1, Value1, ..., NameN, ValueN`.

Example: `'MaxNumTrials', 2000`

MaxNumTrials — Maximum number of random trials

1000 (default) | integer

Maximum number of random trials, specified as the comma-separated pair consisting of `'MaxNumTrials'` and an integer. A single trial uses a minimum number of random points from `xyPoints` to fit a parabolic model. Then, the trial checks the number of inliers within the `maxDistance` from the model. After all trials, the model with the highest number of inliers is selected. Increasing the number of trials improves the robustness of the output at the expense of additional computation.

Confidence — Confidence of final solution

99 (default) | scalar from 0 to 100

Confidence that the final solution finds the maximum number of inliers for the polynomial fit, specified as the comma-separated pair consisting of `'Confidence'` and a scalar from 0 to 100. Increasing this value improves the robustness of the output at the expense of additional computation.

ValidatePolynomialFcn — Function to validate polynomial

function handle

Function to validate polynomial, specified as the comma-separated pair consisting of `'ValidatePolynomialFcn'` and a function handle. The function returns `true` if the polynomial is accepted based on criteria defined in the function. Use this function to reject specific polynomial fits. The function must be of the form:

```
isValid = validatePolynomialFcn(P, varargin)
```

If no function is specified, all polynomials are assumed to be valid.

MaxSamplingAttempts — Maximum number of sample attempts

100 (default) | integer

Maximum number of attempts to find a sample that yields a valid polynomial, specified as the comma-separated pair consisting of `'MaxSamplingAttempts'` and an integer.

Output Arguments

P — Polynomial coefficients

vector of numeric scalars

Polynomial coefficients, returned as a vector of numeric scalars. Each element corresponds to a constant in the polynomial equation with degree `N`. For example, for a second-degree polynomial, Ax^2+Bx+C :

`P = [A B C];`

Data Types: `single` | `double`

inlierIdx — Inlier points

logical vector

Inlier points, returned as a logical vector. The vector is the same length as `xyPoints`, and each element indicates if that point is an inlier for the polynomial fit based on `maxDistance`.

References

- [1] Torr, P. H. S., and A. Zisserman. "MLE-SAC: A New Robust Estimator with Application to Estimating Image Geometry." *Computer Vision and Image Understanding*. Vol. 18, Issue 1, April 2000, pp. 138-156.

See Also

`ransac` | `polyfit` | `polyval`

Introduced in R2017a

extrinsics

Compute location of calibrated camera

Syntax

```
[rotationMatrix,translationVector] = extrinsics(imagePoints,worldPoints,
cameraParams)
```

Description

[rotationMatrix,translationVector] = extrinsics(imagePoints,worldPoints, cameraParams) returns the 3-D rotation matrix and the 3-D translation vector to allow you to transform points from the world coordinate to the camera coordinate system.

Examples

Compute Camera Extrinsics

Create a set of calibration images.

```
images = imageDatastore(fullfile(toolboxdir('vision'),'visiondata', ...
    'calibration', 'slr'));
```

Detect the checkerboard corners in the images.

```
[imagePoints,boardSize] = detectCheckerboardPoints(images.Files);
```

Generate the world coordinates of the checkerboard corners in the pattern-centric coordinate system, with the upper-left corner at (0,0). The square size is in millimeters.

```
squareSize = 29;
worldPoints = generateCheckerboardPoints(boardSize, squareSize);
```

Calibrate the camera.

```
I = readimage(images,1);
imageSize = [size(I,1), size(I,2)];
cameraParams = estimateCameraParameters(imagePoints,worldPoints, ...
    'ImageSize',imageSize);
```

Load image at new location.

```
imOrig = imread(fullfile(matlabroot,'toolbox','vision','visiondata', ...
    'calibration','slr','image9.jpg'));
figure
imshow(imOrig);
title('Input Image');
```

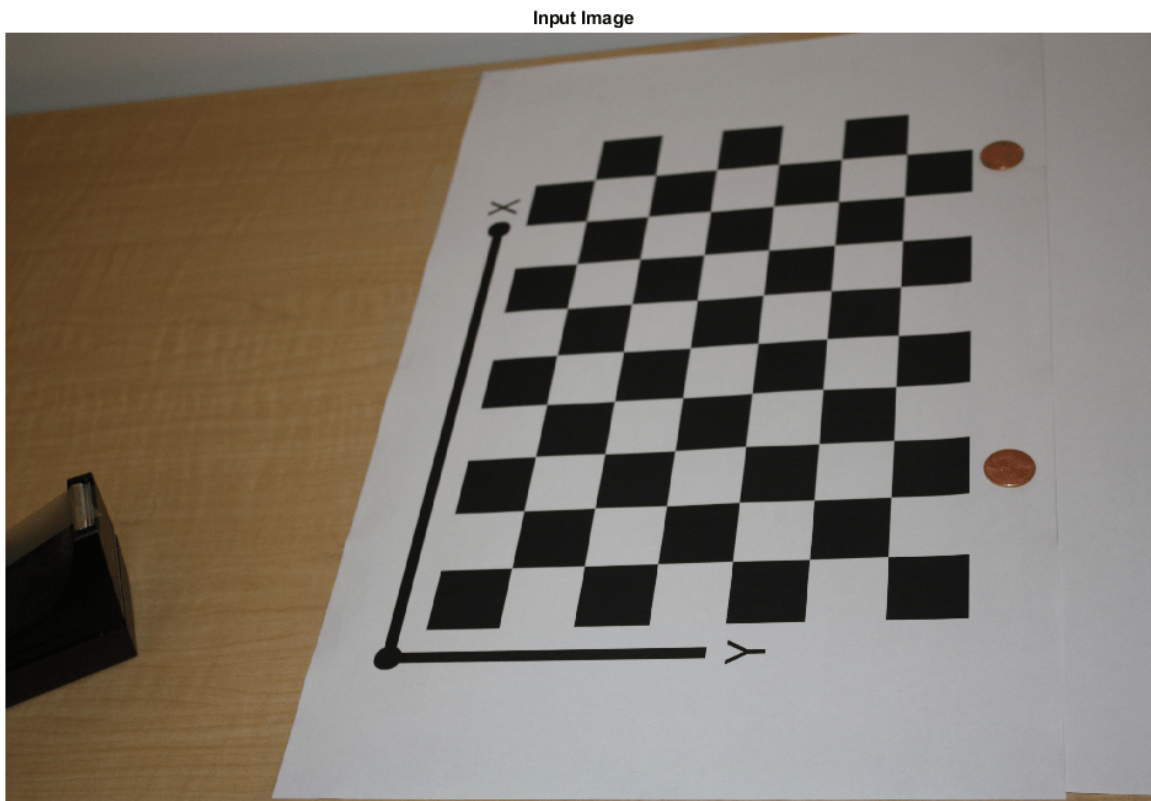

Undistort image.

```
[im,newOrigin] = undistortImage(imOrig,cameraParams,'OutputView','full');
```

Find reference object in new image.

```
[imagePoints,boardSize] = detectCheckerboardPoints(im);
```

Compensate for image coordinate system shift.

```
imagePoints = [imagePoints(:,1) + newOrigin(1), ...
               imagePoints(:,2) + newOrigin(2)];
```

Compute new extrinsics.

```
[rotationMatrix, translationVector] = extrinsics(...
imagePoints,worldPoints,cameraParams);
```

Compute camera pose.

```
[orientation, location] = extrinsicsToCameraPose(rotationMatrix, ...
translationVector);
figure
plotCamera('Location',location,'Orientation',orientation,'Size',20);
hold on
pcshow([worldPoints,zeros(size(worldPoints,1),1)], ...
'VerticalAxisDir','down','MarkerSize',40);
```

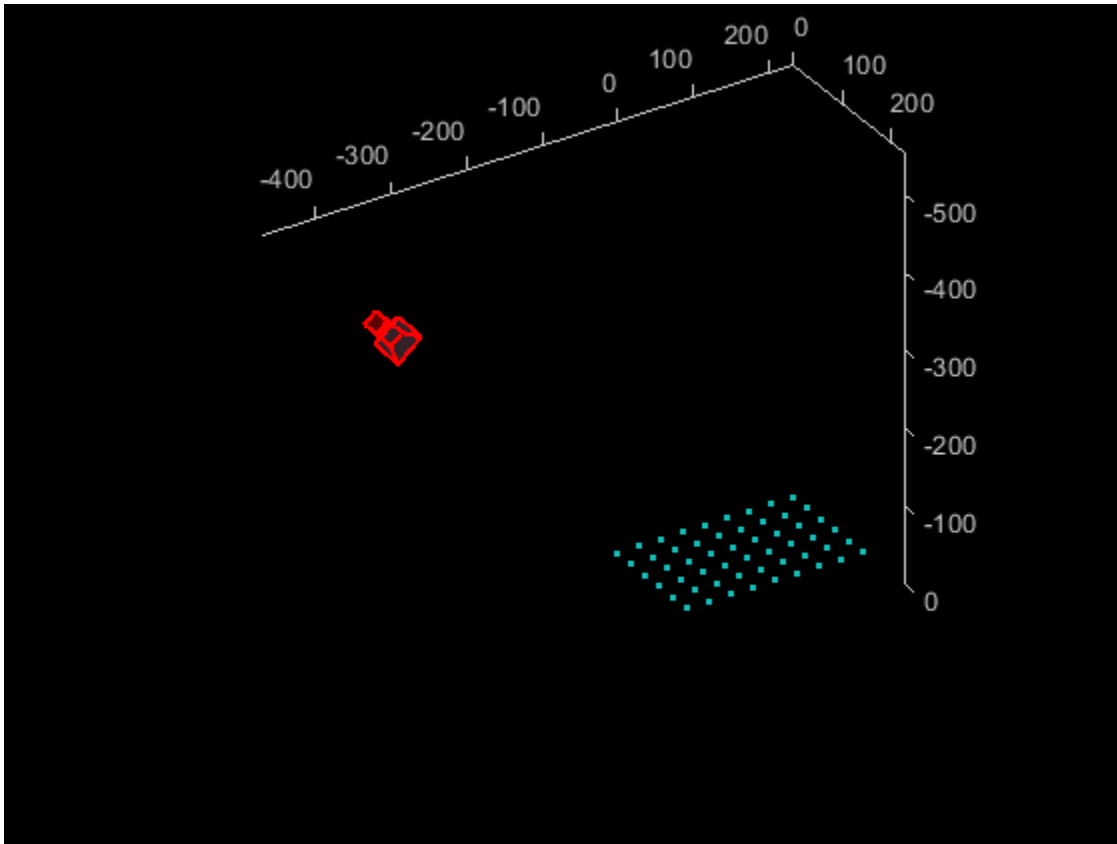
Input Arguments

imagePoints — Image coordinates of points

M-by-2 array

Image coordinates of points, specified as an *M*-by-2 array. The array contains *M* number of $[x, y]$ coordinates. The `imagePoints` and `worldPoints` inputs must both be `double` or both be `single`.

Data Types: `single` | `double`

worldPoints — World coordinates corresponding to image coordinates

M-by-2 matrix

World coordinates corresponding to image coordinates, specified as an *M*-by-2 matrix. The `imagePoints` and `worldPoints` inputs must both be `double` or both be `single`. The function assumes that the points are coplanar with $z=0$ and the number of points, *M*, must be at least 4.

Data Types: `single` | `double`

cameraParams — Camera parameters

`cameraParameters` object | `cameraIntrinsics` object | `fisheyeIntrinsics` object

Object for storing camera parameters, specified as a `cameraParameters`, `cameraIntrinsics`, or `fisheyeIntrinsics` object. These objects are returned by the `estimateCameraParameters` function, the `estimateFisheyeParameters` function, or the **Camera Calibrator** app. The object contains the intrinsic, extrinsic, and lens distortion parameters of a camera.

Output Arguments

rotationMatrix — 3-D rotation

3-by-3 matrix

3-D rotation, returned as a 3-by-3 matrix. The rotation matrix together with the translation vector allows you to transform points from the world coordinate to the camera coordinate system.

$$[x \ y \ z] = [X \ Y \ Z]R + t$$

camera coordinates world coordinates translation vector
rotation matrix

If you set the `imagePoints` and `worldPoints` inputs to class `double`, then the function returns the `rotationMatrix` and `translationVector` as `double`. Otherwise, they are `single`.

translationVector — 3-D translation

3-D translation, returned as a 1-by-3 vector. The rotation matrix together with the translation vector allows you to transform points from the world coordinate to the camera coordinate system.

3-D translation, returned as a 1-by-3 vector.

$$[x \ y \ z] = [X \ Y \ Z]R + t$$

camera coordinates world coordinates translation vector
rotation matrix

If you set the `imagePoints` and `worldPoints` inputs to class `double`, then the function returns the `rotationMatrix` and `translationVector` as `double`. Otherwise, they are `single`.

Algorithms

The `extrinsics` function uses two different algorithms to compute the extrinsics depending on whether `worldPoints` are specified as an M -by-2 matrix. Use an M -by-2 matrix for coplanar points where $z = 0$.

The `extrinsics` function computes the rotation matrix and translation vector for a single image in closed form. During calibration, the extrinsics are estimated numerically to minimize the reprojection errors for all calibration images. Therefore, using the `extrinsics` function on one of the calibration images returns rotation matrix and translation vector slightly different from the ones obtained during calibration.

Extended Capabilities

C/C++ Code Generation

Generate C and C++ code using MATLAB® Coder™.

Usage notes and limitations:

- Use in a MATLAB Function block is not supported.
- Use of a `fishEyeIntrinsics` object as the `cameraParams` input is not supported.

See Also

Camera Calibrator | `plotCamera` | `estimateCameraParameters` | `cameraMatrix` | `cameraParameters` | `cameraIntrinsics` | `estimateFisheyeParameters` | `fisheyeIntrinsics` | `worldToImage` | `extrinsicsToCameraPose` | `cameraPoseToExtrinsics` | `pointsToWorld`

Topics

“Code Generation for Depth Estimation From Stereo Video”

Introduced in R2014a

generalizedDice

Generalized Sørensen-Dice similarity coefficient for image segmentation

Syntax

```
similarity = generalizedDice(X,target)
similarity = generalizedDice(X,target,'DataFormat',dataFormat)
```

Description

The generalized Dice similarity coefficient measures the overlap between two segmented images. Generalized Dice similarity is based on Sørensen-Dice similarity and controls the contribution that each class makes to the similarity by weighting classes by the inverse size of the expected region. When working with imbalanced data sets, class weighting helps to prevent the more prevalent classes from dominating the similarity score.

`similarity = generalizedDice(X,target)` calculates the generalized Sørensen-Dice similarity coefficient between test image `X` and target image `target`.

`similarity = generalizedDice(X,target,'DataFormat',dataFormat)` also specifies the dimension labels, `dataFormat`, of unformatted image data. You must use this syntax when the input are unformatted `darray` objects.

Examples

Calculate Generalized Dice Similarity

Load a pretrained network.

```
data = load('triangleSegmentationNetwork');
net = data.net;
```

Load the triangle image data set using `imageDatastore`.

```
dataDir = fullfile(toolboxdir('vision'),'visiondata','triangleImages');
testImageDir = fullfile(dataDir,'testImages');
imds = imageDatastore(testImageDir);
```

Load ground truth labels for the triangle data set using `pixelLabelDatastore`.

```
labelDir = fullfile(dataDir,'testLabels');
classNames = ["triangle" "background"];
pixelLabelID = [255 0];
pxdsTruth = pixelLabelDatastore(labelDir,classNames,pixelLabelID);
```

Read a sample image and the corresponding ground truth labels.

```
I = readimage(imds,1);
gTruthLabels = readimage(pxdsTruth,1);
```

Run semantic segmentation on the image.

```
[predictions,scores] = semanticseg(I,net);
```

Encode the categorical predictions and targets using the `onehotencode` function.

```
featureDim = ndims(predictions) + 1;
encodedPredictions = onehotencode(predictions,featureDim);
encodedGroundTruthLabels = onehotencode(gTruthLabels,featureDim);
```

Ignore any undefined classes in the encoded data.

```
encodedPredictions(isnan(encodedPredictions)) = 0;
encodedGroundTruthLabels(isnan(encodedGroundTruthLabels)) = 0;
```

Compute generalized Dice similarity coefficient between the segmented image and the ground truth.

```
gDice = generalizedDice(encodedPredictions,encodedGroundTruthLabels)
gDice = 0.4008
```

Calculate Generalized Dice Loss of `dLarray` Input

Create input data as a formatted `dLarray` object containing 32 observations with unnormalized scores for ten output categories.

```
spatial = 10;
numCategories = 10;
batchSize = 32;
X = dLarray(rand(spatial,numCategories,batchSize), 'SCB');
```

Convert unnormalized scores to probabilities of membership of each of the ten categories.

```
X = sigmoid(X);
```

Create target values for membership in the second and sixth category.

```
targets = zeros(spatial,numCategories,batchSize);
targets(:,2,:) = 1;
targets(:,6,:) = 1;
targets = dLarray(targets, 'SCB');
```

Compute the generalized Dice similarity coefficient between probability vectors `X` and `targets` for multi-label classification.

```
Z = generalizedDice(X,targets);
whos Z
```

Name	Size	Bytes	Class	Attributes
Z	1x1x32	262	dLarray	

Calculate the generalized Dice loss.

```
loss = 1 - mean(Z, 'all')
loss =
    1(S) x 1(C) x 1(B) dLarray
```

1

Input Arguments

X — Test image

numeric array | `darray` object

Test image to be analyzed, specified as one of these values.

- A numeric array of any dimension. The last dimension must correspond to classes.
- An unformatted `darray` object. You must specify the data format using the `dataFormat` argument.
- A formatted `darray` object. The `darray` input must contain a channel dimension, 'C' and can contain a batch dimension, 'B'.

`darray` input requires Deep Learning Toolbox.

target — Target image

numeric array | `darray` object

Target image, specified as a numeric array or a `darray` object. The size and format of `target` must match the size and format of the test image, `X`. `darray` input requires Deep Learning Toolbox.

dataFormat — Dimension labels

string scalar | character vector

Dimension labels for unformatted `darray` image input, specified as a string scalar or character vector. Each character in `dataFormat` must be one of these labels:

- S — Spatial
- C — Channel
- B — Batch observations

The format must include one channel label. The format cannot include more than one channel label or batch label. Do not specify the 'dataFormat' argument when the input images are formatted `darray` objects.

Example: 'SSC' indicates that the array has two spatial dimensions and one channel dimension

Example: 'SSCB' indicates that the array has two spatial dimensions, one channel dimension, and one batch dimension

Output Arguments

similarity — Generalized Dice similarity coefficient

numeric scalar | `darray` object

Generalized Dice similarity coefficient, returned as a numeric scalar or a `darray` object with values in the range [0, 1]. A `similarity` of 1 means that the segmentations in the two images are a perfect match.

- If the input arrays are numeric images, then `similarity` is a numeric scalar.
- If the input arrays are `dlarray` objects, then `similarity` is a `dlarray` object of the same dimensionality as the input images. The spatial and channel dimensions of `similarity` are singleton dimensions. There is one generalized Dice measurement for each element along the batch dimension.

More About

Generalized Dice Similarity

Generalized Dice similarity is based on Sørensen-Dice similarity for measuring overlap between two segmented images.

The generalized Dice similarity function S used by `generalizedDice` for the similarity between one image Y and the corresponding ground truth T is given by:

$$S = \frac{2 \sum_{k=1}^K w_k \sum_{m=1}^M Y_{km} T_{km}}{\sum_{k=1}^K w_k \sum_{m=1}^M Y_{km}^2 + T_{km}^2}$$

K is the number of classes, M is the number of elements along the first two dimensions of Y , and w_k is a class specific weighting factor that controls the contribution each class makes to the score. This weighting helps counter the influence of larger regions on the generalized Dice score. w_k is typically the inverse area of the expected region:

$$w_k = \frac{1}{\left(\sum_{m=1}^M T_{km}\right)^2}$$

There are several variations of generalized Dice scores [1], [2]. The `generalizedDice` function uses squared terms to ensure that the derivative is 0 when the two images match [3].

References

- [1] Crum, William R., Oscar Camara, and Derek LG Hill. "Generalized overlap measures for evaluation and validation in medical image analysis." *IEEE Transactions on Medical Imaging*. 25.11, 2006, pp. 1451-1461.
- [2] Sudre, Carole H., et al. "Generalised Dice overlap as a deep learning loss function for highly unbalanced segmentations." *Deep Learning in Medical Image Analysis and Multimodal Learning for Clinical Decision Support*. Springer, Cham, 2017, pp. 240-248.
- [3] Milletari, Fausto, Nassir Navab, and Seyed-Ahmad Ahmadi. "V-Net: Fully Convolutional Neural Networks for Volumetric Medical Image Segmentation". *Fourth International Conference on 3D Vision (3DV)*. Stanford, CA, 2016: pp. 565-571.

Extended Capabilities

GPU Arrays

Accelerate code by running on a graphics processing unit (GPU) using Parallel Computing Toolbox™.

This function fully supports GPU arrays. For more information, see "Run MATLAB Functions on a GPU" (Parallel Computing Toolbox).

See Also

`dice` | `darray` | `dicePixelClassificationLayer` | `semanticseg` | `onehotencode`

Introduced in R2021a

generateCheckerboardPoints

Generate checkerboard corner locations

Syntax

```
[worldPoints] = generateCheckerboardPoints(boardSize,squareSize)
```

Description

`[worldPoints] = generateCheckerboardPoints(boardSize,squareSize)` returns an M -by-2 matrix containing M $[x, y]$ corner coordinates for the squares on a checkerboard. The point $[0,0]$ corresponds to the lower-right corner of the top-left square of the board.

Examples

Generate and Plot Corners of an 8-by-8 Checkerboard

Generate the checkerboard, and obtain world coordinates.

```
I = checkerboard;
squareSize = 10;
worldPoints = generateCheckerboardPoints([8 8], squareSize);
```

Offset the points, placing the first point at the lower-right corner of the first square.

```
imshow(insertMarker(I, worldPoints + squareSize));
```

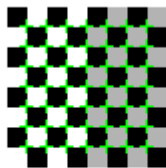

Input Arguments

boardSize — Generated checkerboard dimensions

2-element $[height, width]$ vector

Generated checkerboard dimensions, specified as a 2-element $[height, width]$ vector. You express the dimensions of the checkerboard in number of squares.

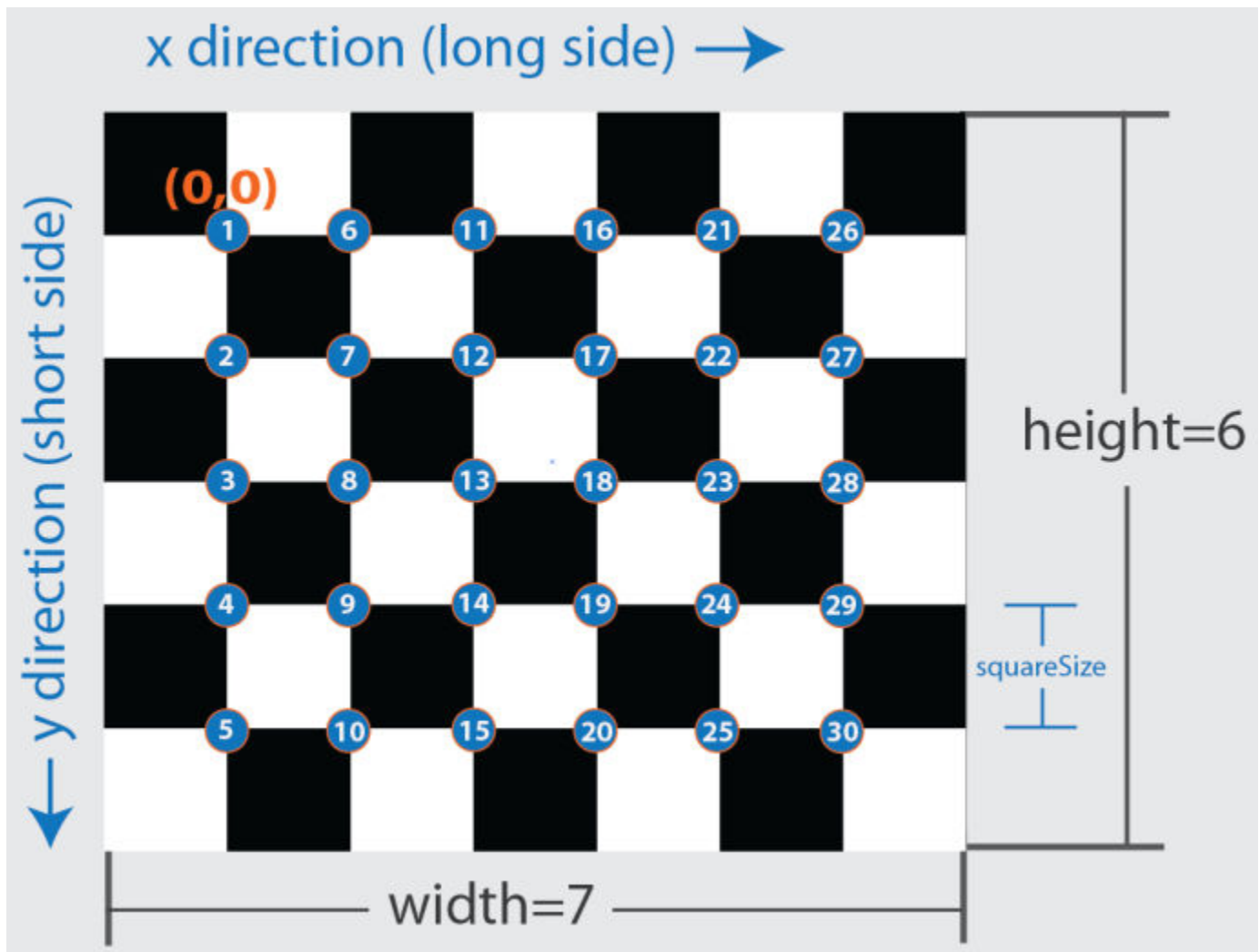
**squareSize – Generated checkerboard square side length**

scalar

Checkerboard square side length, specified as a scalar in world units. You express world units as a measurement, such as millimeters or inches.

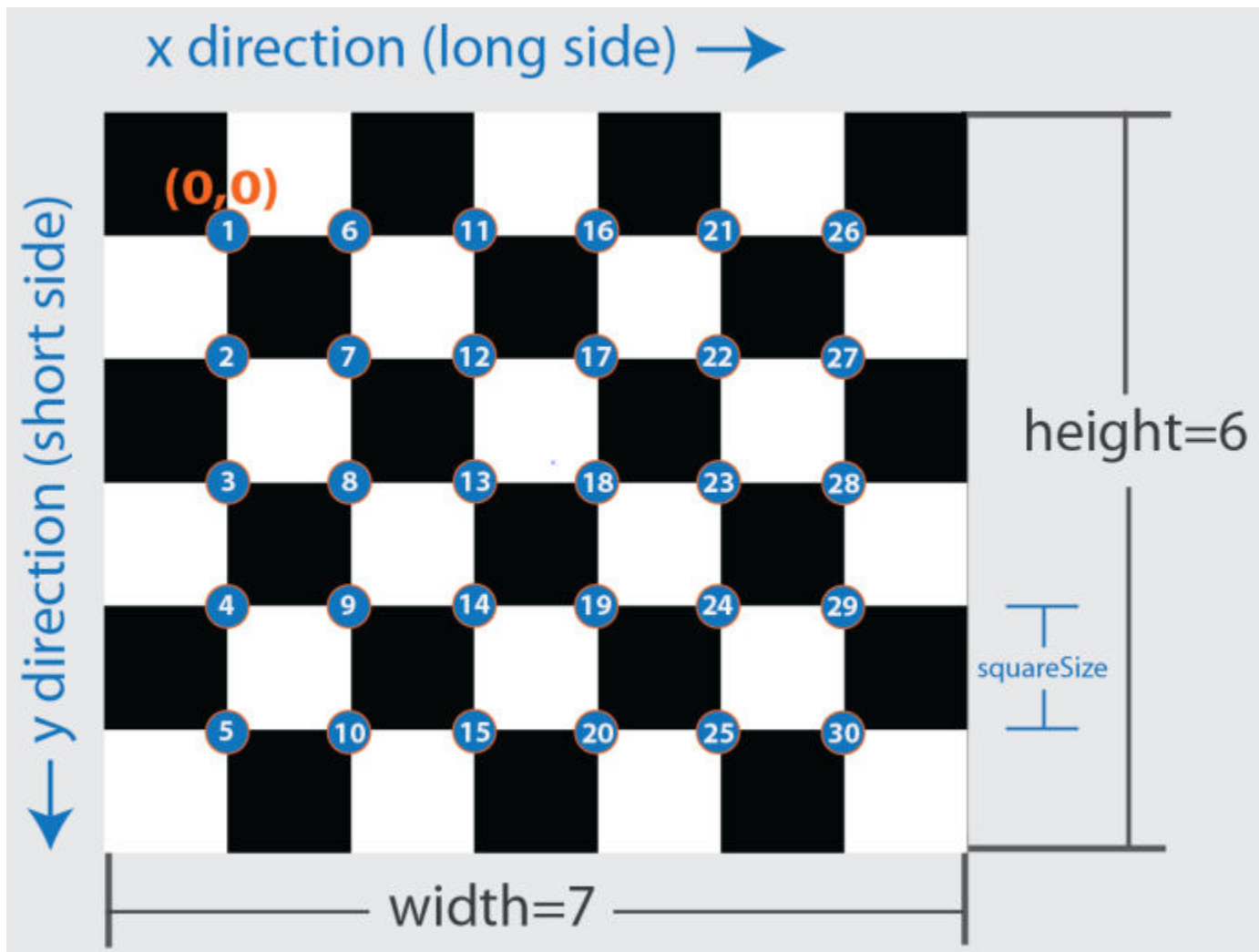

Output Arguments

worldPoints — Generated checkerboard corner coordinates

M-by-2 matrix

Generated checkerboard corner coordinates, returned as an *M*-by-2 matrix of *M* number of [x y] coordinates. The coordinates represent the corners of the squares on the checkerboard. The point [0,0] corresponds to the lower-right corner of the top-left square of the board. The number of points, *M*, that the function returns are based on the number of squares on the checkerboard. This value is set with the boardSize parameter.

$$M = (\text{boardSize}(1)-1) * (\text{boardSize}(2)-1)$$

Extended Capabilities

C/C++ Code Generation

Generate C and C++ code using MATLAB® Coder™.

See Also

`estimateCameraParameters` | `detectCheckerboardPoints` | `cameraParameters` | `stereoParameters` | **Camera Calibrator**

Topics

“Measuring Planar Objects with a Calibrated Camera”
“Using the Single Camera Calibrator App”

Introduced in R2013b

indexImages

Create image search index

Syntax

```
imageIndex = indexImages(imds)
imageIndex = indexImages(imds,bag)
imageIndex = indexImages( ___,Name,Value)
```

Description

`imageIndex = indexImages(imds)` creates an `invertedImageIndex` object, `imageIndex`, that contains a search index for `imds`. Use `imageIndex` with the `retrieveImages` function to search for images.

`imageIndex = indexImages(imds,bag)` returns a search index that uses a custom `bagOfFeatures` object, `bag`. Use this syntax with the `bag` you created when you want to modify the number of visual words or the feature type used to create the image search index for `imds`.

`imageIndex = indexImages(___,Name,Value)` uses additional options specified by one or more `Name,Value` pair arguments, using any of the preceding syntaxes.

This object supports parallel computing using multiple MATLAB workers. Enable parallel computing from the “Computer Vision Toolbox Preferences” dialog box. To open Computer Vision Toolbox preferences, on the **Home** tab, in the **Environment** section, click **Preferences**. Then select **Computer Vision Toolbox**.

Examples

Search Image Set Using a Query Image

Create an image set.

```
setDir = fullfile(toolboxdir('vision'),'visiondata','imageSets','cups');
imds = imageDatastore(setDir);
```

Index the image set.

```
imageIndex = indexImages(imds)
```

Creating an inverted image index using Bag-Of-Features.

Creating Bag-Of-Features.

```
* Selecting feature point locations using the Detector method.
* Extracting SURF features from the selected feature point locations.
** detectSURFFeatures is used to detect key points for feature extraction.
```

```
* Extracting features from 6 images...done. Extracted 1708 features.
* Keeping 80 percent of the strongest features from each category.
* Balancing the number of features across all image categories to improve clustering.
** Image category 1 has the least number of strongest features: 1366.
** Using the strongest 1366 features from each of the other image categories.

* Creating a 1366 word visual vocabulary.
* Number of levels: 1
* Branching factor: 1366
* Number of clustering steps: 1

* [Step 1/1] Clustering vocabulary level 1.
* Number of features      : 1366
* Number of clusters     : 1366
* Initializing cluster centers...100.00%.
* Clustering...completed 1/100 iterations (~0.04 seconds/iteration)...converged in 1 iterations.

* Finished creating Bag-Of-Features
```

Encoding images using Bag-Of-Features.

```
* Encoding 6 images...done.
Finished creating the image index.
```

```
imageIndex =
  invertedImageIndex with properties:

    ImageLocation: {6x1 cell}
    ImageWords: [6x1 vision.internal.visualWords]
    WordFrequency: [1x1366 double]
    BagOfFeatures: [1x1 bagOfFeatures]
    ImageID: [1 2 3 4 5 6]
    MatchThreshold: 0.0100
    WordFrequencyRange: [0.0100 0.9000]
```

Display the image set using the `montage` function.

```
thumbnailGallery = [];
for i = 1:length(imds.Files)
    I = readimage(imds,i);
    thumbnail = imresize(I,[300 300]);
    thumbnailGallery = cat(4,thumbnailGallery,thumbnail);
end

figure
montage(thumbnailGallery);
```



Select a query image.

```
queryImage = readimage(imds,2);  
figure  
imshow(queryImage)
```



Search the image set for similar image using query image. The best result is first.

```
indices = retrieveImages(queryImage, imageIndex)
```

indices = 5x1 uint32 column vector

```
2  
1  
4  
3  
5
```

```
bestMatchIdx = indices(1);
```

Display the best match from the image set.

```
bestMatch = imageIndex.ImageLocation{bestMatchIdx}
```

```
bestMatch =
```

```
'B:\matlab\toolbox\vision\visiondata\imageSets\cups\blueCup.jpg'
```

```
figure
```

```
imshow(bestMatch)
```



Create Search Index Using Custom Bag of Features

Create an image set.

```
setDir = fullfile(toolboxdir('vision'),'visiondata','imageSets','cups');
imgSets = imageSet(setDir, 'recursive');
```

Display image set.

```
thumbnailGallery = [];
for i = 1:imgSets.Count
    I = read(imgSets, i);
    thumbnail = imresize(I, [300 300]);
    thumbnailGallery = cat(4, thumbnailGallery, thumbnail);
end
```

```
figure
montage(thumbnailGallery);
```



Train a bag of features using a custom feature extractor.

```
extractor = @exampleBagOfFeaturesExtractor;
bag = bagOfFeatures(imgSets, 'CustomExtractor', extractor);
```

Creating Bag-Of-Features.

```
-----
* Image category 1: cups
* Extracting features using a custom feature extraction function: exampleBagOfFeaturesExtractor.
* Extracting features from 6 images in image set 1...done. Extracted 115200 features.
```

```
* Keeping 80 percent of the strongest features from each category.

* Creating a 500 word visual vocabulary.
* Number of levels: 1
* Branching factor: 500
* Number of clustering steps: 1

* [Step 1/1] Clustering vocabulary level 1.
* Number of features      : 92160
* Number of clusters     : 500
* Initializing cluster centers...100.00%.
* Clustering...completed 45/100 iterations (~0.23 seconds/iteration)...converged in 45 iterations

* Finished creating Bag-Of-Features
```

Use the trained bag of features to index the image set.

```
imageIndex = indexImages(imgSets,bag,'Verbose',false)
```

```
imageIndex =
  invertedImageIndex with properties:
    ImageLocation: {6x1 cell}
    ImageWords: [6x1 vision.internal.visualWords]
    WordFrequency: [1x500 double]
    BagOfFeatures: [1x1 bagOfFeatures]
    ImageID: [1 2 3 4 5 6]
    MatchThreshold: 0.0100
    WordFrequencyRange: [0.0100 0.9000]
```

```
queryImage = read(imgSets,4);
```

```
figure
imshow(queryImage)
```



Search for the image from image index using query image.

```
indices = retrieveImages(queryImage,imageIndex);  
bestMatch = imageIndex.ImageLocation{indices(1)};  
figure  
imshow(bestMatch)
```



Input Arguments

imds – Images

imageDatastore object

Images, specified as an `imageDatastore` object. The object stores a collection of images.

bag — Bag of visual words

`bagOfFeatures` object

Bag of visual words, specified as a `bagOfFeatures` object.

Name-Value Pair Arguments

Specify optional comma-separated pairs of `Name`, `Value` arguments. `Name` is the argument name and `Value` is the corresponding value. `Name` must appear inside quotes. You can specify several name and value pair arguments in any order as `Name1, Value1, . . . , NameN, ValueN`.

Example: `'Verbose', true` sets the `'Verbose'` property to `true`

SaveFeatureLocations — Save feature locations

`true` (default) | `false`

Save feature locations, specified as the comma-separated pair consisting of `'SaveFeatureLocations'` and a logical scalar. When set to `true`, the image feature locations are saved in the `imageIndex` output object. Use location data to verify spatial or geometric image search results. If you do not require feature locations, set this property to `false` to reduce memory consumption.

Verbose — Display progress information

`true` (default) | `false`

Display progress information, specified as the comma-separated pair consisting of `'Verbose'` and a logical scalar.

Output Arguments

imageIndex — Image search index

`invertedImageIndex` object

Image search index, returned as an `invertedImageIndex` object.

Algorithms

`imageIndex` uses the bag-of-features framework with the speeded-up robust features (SURF) detector and extractor to learn a vocabulary of 20,000 visual words. The visual words are then used to create an index that maps visual words to the images in `imds`. You can use the index to search for images within `imds` that are similar to a given query image.

See Also

`retrieveImages` | `evaluateImageRetrieval` | `imageDatastore` | `bagOfFeatures` | `invertedImageIndex`

Topics

“Image Retrieval Using Customized Bag of Features”

“Image Retrieval with Bag of Visual Words”

Introduced in R2015a

integralFilter

Filter using integral image

Syntax

```
J = integralFilter(intI,H)
```

Description

`J = integralFilter(intI,H)` filters an image, given its integral image, `intI`, and filter object, `H`. The `integralKernel` function returns the filter object used for the input to the `integralFilter`.

This function uses integral images for filtering an image with box filters. You can obtain the integral image, `intI`, by calling the `integralImage` function. The filter size does not affect the speed of the filtering operation. Thus, the `integralFilter` function is ideally suited to use for fast analysis of images at different scales, as demonstrated by the Viola-Jones algorithm [1].

Tips

Because the `integralFilter` function uses correlation for filtering, the filter is not rotated before computing the result.

Input Arguments

`intI`

Integral image. You can obtain the integral image, `intI`, by calling the `integralImage` function. The class for this value can be `double` or `single`.

`H`

Filter object. You can obtain the filter object, `H`, by calling the `integralKernel` function.

Output Arguments

`J`

Filtered image. The filtered image, `J`, returns only the parts of correlation that are computed without padding. This results in `size(J) = size(intI) - H.Size` for an upright filter, and `size(J) = size(intI) - H.Size - [0 1]` for a rotated filter. This function uses correlation for filtering.

Examples

Blur an Image Using an Average Filter

Read and display the input image.

```
I = imread('pout.tif');  
imshow(I);
```



Compute the integral image.

```
intImage = integralImage(I);
```

Apply a 7-by-7 average filter.

```
avgH = integralKernel([1 1 7 7], 1/49);  
J = integralFilter(intImage, avgH);
```

Cast the result back to the same class as the input image.

```
J = uint8(J);  
figure  
imshow(J);
```



Find Vertical and Horizontal Edges in Image

Construct Haar-like wavelet filters to find vertical and horizontal edges in an image.

Read the input image and compute the integral image.

```
I = imread('pout.tif');
intImage = integralImage(I);
```

Construct Haar-like wavelet filters. Use the dot notation to find the vertical filter from the horizontal filter.

```
horiH = integralKernel([1 1 4 3; 1 4 4 3],[-1, 1]);
vertH = horiH.'
```

```
vertH =
    integralKernel with properties:
```

```
    BoundingBoxes: [2x4 double]
    Weights: [-1 1]
    Coefficients: [4x6 double]
    Center: [2 3]
    Size: [4 6]
    Orientation: 'upright'
```

Display the horizontal filter.

```
imtool(horiH.Coefficients, 'InitialMagnification','fit');
```

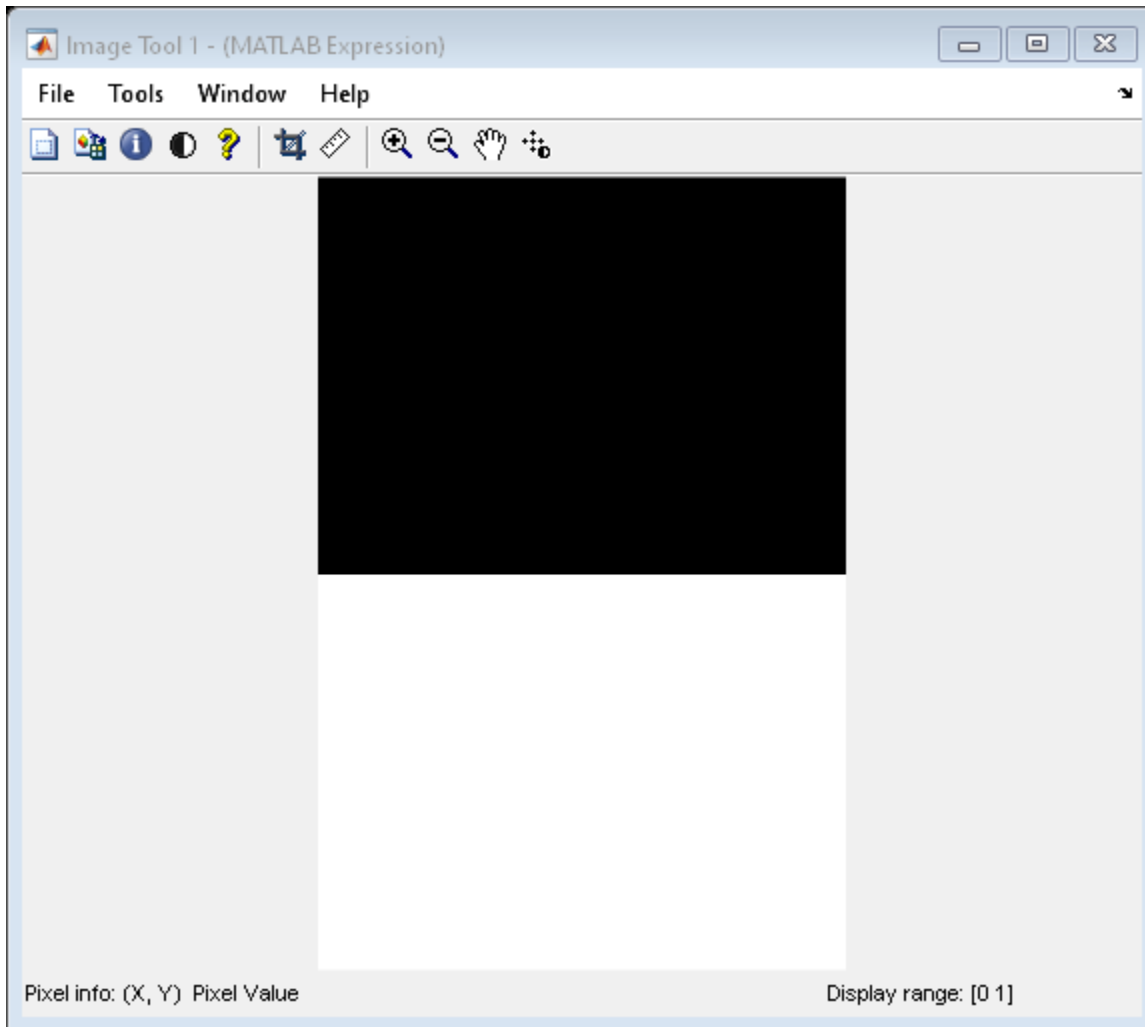

Compute the filter responses.

```
horiResponse = integralFilter(intImage,horiH);  
vertResponse = integralFilter(intImage,vertH);
```

Display the results.

```
figure;  
imshow(horiResponse,[]);  
title('Horizontal edge responses');
```

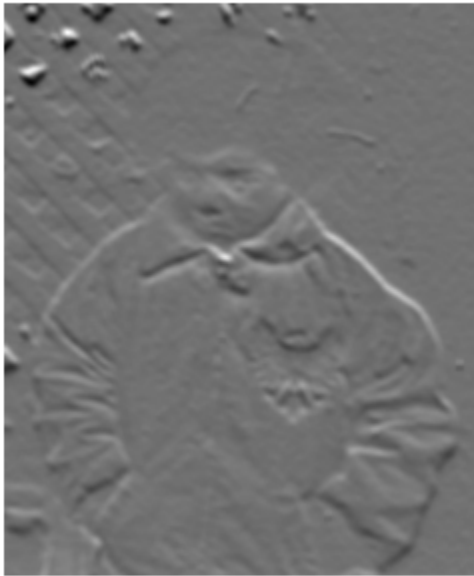
Horizontal edge responses

```
figure;  
imshow(vertResponse,[]);  
title('Vertical edge responses');
```

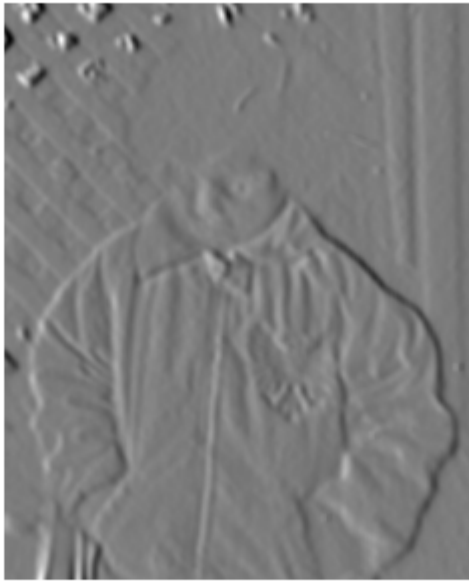
Vertical edge responses**Compute a Rotated Edge Response Using Integral Filter**

Read the input image.

```
I = imread('pout.tif');
```

Compute 45 degree edge responses of the image.

```
intImage = integralImage(I,'rotated');  
figure;  
imshow(I);  
title('Original Image');
```

Original Image

Construct 45 degree rotated Haar-like wavelet filters.

```
rotH = integralKernel([2 1 2 2;4 3 2 2],[1 -1], 'rotated');  
rotHTrans = rotH.'
```

Visualize the filter rotH.

```
figure;  
imshow(rotH.Coefficients, [], 'InitialMagnification', 'fit');
```



Compute filter responses.

```
rothResponse = integralFilter(intImage,roth);  
rothTransResponse = integralFilter(intImage,rothTrans);
```

Display results.

```
figure;  
imshow(rothResponse, []);  
title('Response for SouthWest-NorthEast edges');
```

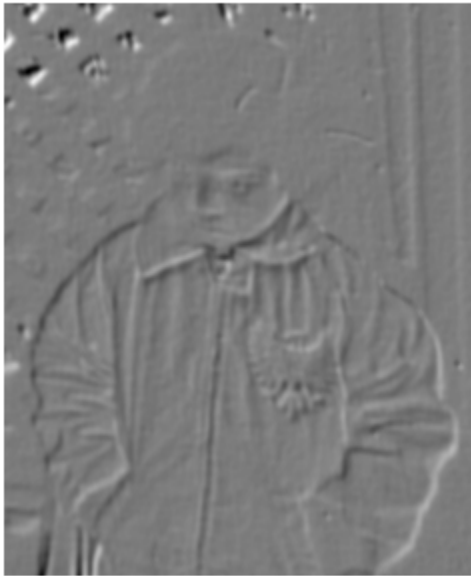
Response for SouthWest-NorthEast edges

```
figure;  
imshow(rothTransResponse, []);  
title('Response for NorthWest-SouthEast edges');
```

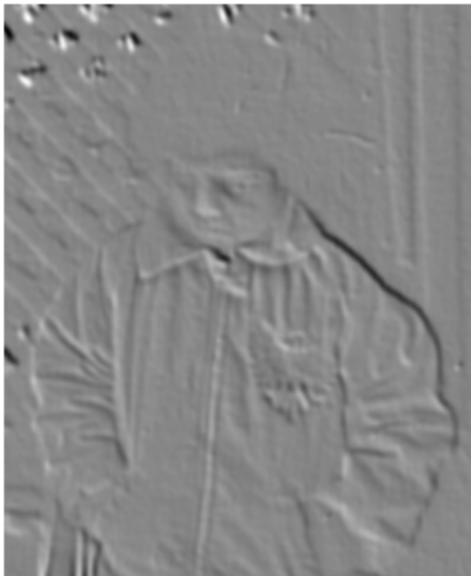
Response for NorthWest-SouthEast edges

References

- [1] Viola, Paul and Michael J. Jones, "Rapid Object Detection using a Boosted Cascade of Simple Features", *Proceedings of the 2001 IEEE Computer Society Conference on Computer Vision and Pattern Recognition*, 2001. Volume: 1, pp.511-518.

See Also

`cumsum` | `integralImage` | `integralKernel`

Introduced in R2012a

insertMarker

Insert markers in image or video

Syntax

```
RGB = insertMarker(I,position)
RGB = insertMarker(I,position,marker)
RGB = insertMarker(___,Name,Value)
```

Description

`RGB = insertMarker(I,position)` returns a truecolor image with inserted plus (+) markers. The input image, `I`, can be either a truecolor or grayscale image. You draw the markers by overwriting pixel values. The input `position` can be either an M -by-2 matrix of M number of $[x\ y]$ pairs or one of the “Point Feature Types”.

`RGB = insertMarker(I,position,marker)` returns a truecolor image with the marker type of markers inserted.

`RGB = insertMarker(___,Name,Value)` uses additional options specified by one or more `Name,Value` pair arguments.

Examples

Draw Markers on an Image

Read the image.

```
I = imread('peppers.png');
```

Insert a plus (+) marker.

```
RGB = insertMarker(I,[147 279]);
```

Draw four x-marks.

```
pos    = [120 248;195 246;195 312;120 312];
color  = {'red','white','green','magenta'};
RGB = insertMarker(RGB,pos,'x','color',color,'size',10);
```

Display the image.

```
imshow(RGB);
```



Input Arguments

I — Input image

M-by-*N*-by-3 truecolor | *M*-by-*N* 2-D grayscale image

Input image, specified in truecolor or 2-D grayscale.

Data Types: single | double | int16 | uint8 | uint16

position — Position of marker

M-by-2 matrix | vector

Position of marker, specified as either an *M*-by-2 matrix of *M* number of [x y] pairs or one of the “Point Feature Types”. The center positions for the markers are defined by the [xy] pairs of the matrix or by the Location property of the point feature object.

Data Types: single | double | int8 | int16 | int32 | int64 | uint8 | uint16 | uint32 | uint64

marker — Type of marker

'plus' (default) | character vector | string scalar

Type of marker, specified as a character vector. The vector can be full text or the corresponding symbol.

Character Vector	Symbol
'circle'	'o'
'x-mark'	'x'
'plus'	'+'
'star'	'*'
'square'	's'

Data Types: char

Name-Value Pair Arguments

Specify optional comma-separated pairs of **Name**, **Value** arguments. **Name** is the argument name and **Value** is the corresponding value. **Name** must appear inside quotes. You can specify several name and value pair arguments in any order as **Name1**, **Value1**, . . . , **NameN**, **ValueN**.

Example: 'Color', 'yellow' specifies yellow for the marker color.

Size — Size of marker

3 (default) | scalar value

Size of marker in pixels, specified as the comma-separated pair consisting of 'Size' and a scalar value in the range [1, inf).

Data Types: single | double | int8 | int16 | int32 | int64 | uint8 | uint16 | uint32 | uint64

Color — Marker color

'green' (default) | character vector | cell array of character vectors | string scalar | string array

Marker color, specified as the comma-separated pair consisting of 'Color' and either a character vector, cell array of character vectors, vector, or matrix. You can specify a different color for each marker or one color for all markers.

To specify a color for each marker, set **Color** to a cell array of color character vectors or an M -by-3 matrix of M number of RGB (red, green, and blue) color values.

To specify one color for all markers, set **Color** to either a color character vector or an [R G B] vector. The [R G B] vector contains the red, green, and blue values.

Supported colors are: 'blue', 'green', 'red', 'cyan', 'magenta', 'yellow', 'black', and 'white'.

Data Types: cell | char | uint8 | uint16 | int16 | double | single

Output Arguments

RGB — Output image

M -by- N -by-3 truecolor

Output image, returned as a truecolor image.

Extended Capabilities

C/C++ Code Generation

Generate C and C++ code using MATLAB® Coder™.

- The input argument marker and the name-value pair argument 'Color' must be compile-time constants.

See Also

[insertObjectAnnotation](#) | [cornerPoints](#) | [SURFPoints](#) | [MSERRegions](#) | [BRISKPoints](#) | [ORBPoints](#) | [insertShape](#) | [insertText](#) | “Point Feature Types”

Topics

“Insert Circle and Filled Shapes on an Image” on page 3-652

“Insert Numbers and Text on Image” on page 3-658

Introduced in R2013a

insertObjectAnnotation

Annotate truecolor or grayscale image or video stream

Syntax

```
RGB = insertObjectAnnotation(I,shape,position,label)
RGB = insertObjectAnnotation(I,shape,position,label,Name,Value)
```

```
insertObjectAnnotation(I,'rectangle',position,label)
insertObjectAnnotation(I,'circle',position,label)
```

Description

`RGB = insertObjectAnnotation(I,shape,position,label)` returns a truecolor image annotated with shape and label at the location specified by position.

`RGB = insertObjectAnnotation(I,shape,position,label,Name,Value)` uses additional options specified by one or more Name, Value pair arguments.

`insertObjectAnnotation(I,'rectangle',position,label)` inserts rectangles and labels at the location indicated by the position matrix.

`insertObjectAnnotation(I,'circle',position,label)` inserts circles and corresponding labels at the location indicated by the position matrix.

Examples

Annotate Image with Numbers and Strings

Read image.

```
I = imread('board.tif');
```

Create labels of floating point numbers. The floating point numbers relate to confidence value labels.

```
label_str = cell(3,1);
conf_val = [85.212 98.76 78.342];
for ii=1:3
    label_str{ii} = ['Confidence: ' num2str(conf_val(ii),'%0.2f') '%'];
end
```

Set the position for the rectangles as [x y width height].

```
position = [23 373 60 66;35 185 77 81;77 107 59 26];
```

Insert the labels.

```
RGB = insertObjectAnnotation(I,'rectangle',position,label_str,...
    'TextBoxOpacity',0.9,'FontSize',18);
```

Display the annotated image.

```
figure  
imshow(IMG)  
title('Annotated chips');
```

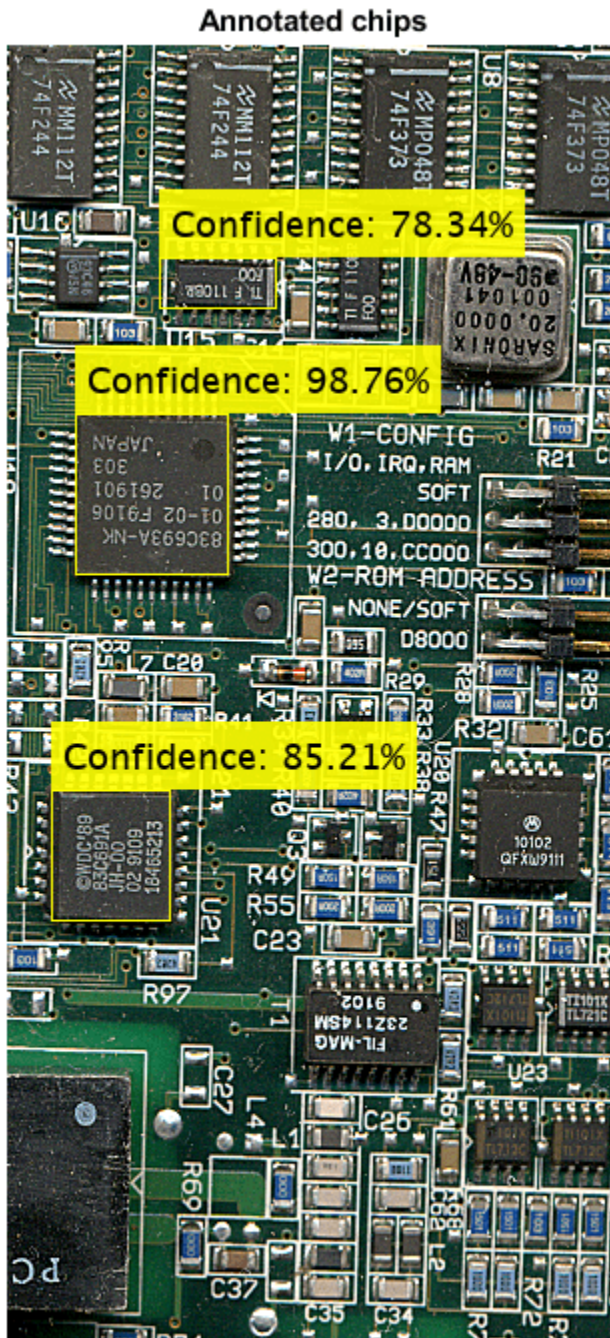

Annotate Image with Integer Numbers

Read image.

```
I = imread('coins.png');
```

Set positions for the circles. The first two values represents the center at (x,y) and the third value is the radius.

```
position = [96 146 31;236 173 26];
```

Set the label to display the integers 5 and 10 (U.S. cents).

```
label = [5 10];
```

Insert the annotations.

```
RGB = insertObjectAnnotation(I,'circle',position,label,'LineWidth',3,'Color',{'cyan','yellow'},'
```

Display.

```
figure
imshow(RGB)
title('Annotated coins');
```

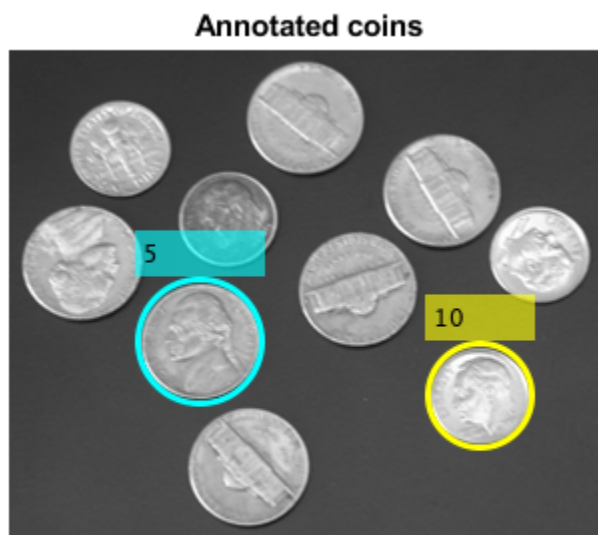

Input Arguments

I — Truecolor or grayscale image

M-by-*N*-by-3 truecolor | *M*-by-*N* 2-D grayscale image

Truecolor or grayscale image, specified as an image or video stream. The input image can be either an M -by- N -by-3 truecolor or a M -by- N 2-D grayscale image.

Data Types: `double` | `single` | `uint8` | `uint16` | `int16`

shape — Rectangle or circle annotation

`'rectangle'` | `'circle'`

Rectangle or circle annotation, specified as a character vector indicating the annotation shape.

Data Types: `char`

position — Location and size of the annotation shape

M -by-3 matrix | M -by-4 matrix

Location and size of the annotation shape, specified as an M -by-3 or M -by-4 matrix. When you specify a rectangle, the position input matrix must be an M -by-4 matrix. Each row, M , specifies a rectangle as a four-element vector, $[x\ y\ width\ height]$. The elements, x and y , indicate the upper-left corner of the rectangle, and the *width* and *height* specify the size.

When you specify a circle, the position input matrix must be an M -by-3 matrix, where each row, M , specifies a three-element vector $[x\ y\ r]$. The elements, x and y , indicate the center of the circle and r specifies the radius.

Example: `position = [50 120 75 75]`

A rectangle with top-left corner located at $x=50$, $y=120$, with a width and height of 75 pixels.

Example: `position = [96 146 31]`

A circle with center located at $x=96$, $y=146$ and a radius of 31 pixels.

Example: `position = [23 373 60 66;35 185 77 81;77 107 59 26]`

Location and size for three rectangles.

label — Label to associate with a shape

M -element numeric vector | string | categorical labels | cell array of ASCII character vectors

Label to associate with a shape, specified as an M numeric vector, string, categorical labels, or a cell array of ASCII character vectors. The character, string, or categorical labels must be encoded as ASCII characters. The cell array must be the of length equal to the number of shape positions. You can specify a scalar label for all shapes as a numeric scalar, string, or categorical.

Example: `label = [5 10]`, where the function marks the first shape with the label, 5, and the second shape with the label, 10.

Name-Value Pair Arguments

Specify optional comma-separated pairs of `Name`, `Value` arguments. `Name` is the argument name and `Value` is the corresponding value. `Name` must appear inside quotes. You can specify several name and value pair arguments in any order as `Name1, Value1, . . . , NameN, ValueN`.

Example: `'Color', 'white'` sets the color for the label text box to white.

Font — Font face of text

`'LucidaSansRegular'` (default) | character vector | string scalar

Font face of text, specified as the comma-separated pair consisting of 'Font' and a character vector. The font face must be one of the available truetype fonts installed on your system. To get a list of available fonts on your system, type `listTrueTypeFonts` at the MATLAB command prompt.

Data Types: char

FontSize – Label text font size

12 (default) | integer in the range of [8 72]

Label text font size, specified as the comma-separated pair consisting of 'FontSize' and an integer corresponding to points in the range of [8 72].

Data Types: double | single | int8 | int16 | int32 | int64 | uint8 | uint16 | uint32 | uint64

LineWidth – Shape border line width

1 (default)

Shape border line width, specified as the comma-separated pair consisting of 'LineWidth' and a positive scalar integer in pixels.

Color – Color for shape and corresponding label text box

'yellow' (default) | character vector | string scalar | [R G B] vector | cell array | string array | M -by-3 matrix

Color for shape and for corresponding label text box, specified as the comma-separated pair consisting of 'Color' and either a character vector, an [R G B] vector, a cell array, or an M -by-3 matrix.

To specify one color for all shapes, set this parameter to either a character vector or an [R G B] vector. To specify a color for each of the M shapes, set this parameter to a cell array of M character vectors. Alternatively, you can specify an M -by-3 matrix of RGB values for each annotation. RGB values must be in the range of the input image data type.

Supported colors: 'blue', 'green', 'cyan', 'red', 'magenta', 'black', and 'white'.

Data Types: char | uint8 | uint16 | int16 | double | single | cell

TextColor – Color of text in text label

'black' (default) | character vector | string scalar | [R G B] vector | cell array | string array | M -by-3 matrix

Color of text in text label, specified as the comma-separated pair consisting of 'TextColor' and either a character vector, an [R G B] vector, a cell array, or an M -by-3 matrix. To specify one color for all text, set this parameter to either a character vector or an [R G B] vector. To specify a color for each of the M text labels, set this parameter to a cell array of M character vectors. Alternatively, you can specify an M -by-3 matrix of RGB values for each annotation. RGB values must be in the range of the input image data type.

Supported colors: 'blue', 'green', 'cyan', 'red', 'magenta', 'yellow', and 'white'.

Data Types: char | uint8 | uint16 | int16 | double | single | cell

TextBoxOpacity – Opacity of text label box background

0.6 (default) | range of [0 1]

Opacity of text label box background, specified as the comma-separated pair consisting of 'TextBoxOpacity' and a scalar defining the opacity of the background of the label text box. Specify this value in the range of 0 to 1.

Data Types: double | single | int8 | int16 | int32 | int64 | uint8 | uint16 | uint32 | uint64

Output Arguments

RGB — Tricolor or grayscale image with annotation

M-by-*N*-by-3 truecolor

Tricolor image with annotation, returned as an image or video stream.

Data Types: double | single | uint8 | uint16 | int16

Extended Capabilities

C/C++ Code Generation

Generate C and C++ code using MATLAB® Coder™.

Usage notes and limitations:

- Input image must be bounded. See “Specify Upper Bounds for Variable-Size Arrays” (MATLAB Coder).
- See “System Objects in MATLAB Code Generation” (MATLAB Coder).

See Also

insertMarker | insertText | insertShape | insertObjectMask

Topics

“Choose Function to Visualize Detected Objects”

Introduced in R2012b

insertObjectMask

Insert masks in image or video stream

Syntax

```
RGB = insertObjectMask(I,BW)
RGB = insertObjectMask(I,maskstack)
RGB = insertObjectMask( ____,Name,Value)
```

Description

`RGB = insertObjectMask(I,BW)` inserts a mask `BW` into the specified image `I` and returns the result as a truecolor image `RGB`.

`RGB = insertObjectMask(I,maskstack)` inserts a set of masks `maskstack` into the specified image `I` and returns the result as a truecolor image `RGB`.

`RGB = insertObjectMask(____,Name,Value)` specifies options using one or more name-value pair arguments in addition to the input arguments in previous syntaxes.

Examples

Insert Masks with White Border to Differentiate Close Objects

Read an image into the workspace.

```
I = imread('visionteam1.jpg');
```

Load a stack of binary masks.

```
load('visionteam1Maskstack.mat')
```

Insert the masks into the image.

```
RGB = insertObjectMask(I,maskstack,'LineColor','white','LineWidth',2);
```

Display the image with the masks inserted.

```
figure
imshow(RGB)
```



Insert Masks with Unique Color for Each Mask

Read an image into the workspace.

```
I = imread('visionteam1.jpg');
```

Load a stack of binary mask images.

```
load('visionteam1Maskstack.mat');
```

Insert the masks into the image, specifying a unique color for each mask.

```
numMasks = size(maskstack,3);  
RGB = insertObjectMask(I,maskstack,'Color',lines(numMasks));
```

Display the image with the inserted masks.

```
figure  
imshow(RGB)
```



Input Arguments

I — Input image

truecolor image | grayscale image

Input image, specified as a truecolor (RGB) image, m -by- n -by-3 array, or a grayscale image, m -by- n array.

Data Types: single | double | int16 | uint8 | uint16

BW — Input mask image

m -by- n logical matrix

Input mask image, specified as an m -by- n logical matrix.

Data Types: logical

maskstack — Stack of mask images

m -by- n -by- P logical array

Stack of mask images, specified as an m -by- n -by- P logical array, where P is the total number of masks in the stack.

`maskstack` has the same width and height as `I`.

Data Types: `logical`

Name-Value Pair Arguments

Specify optional comma-separated pairs of `Name`, `Value` arguments. `Name` is the argument name and `Value` is the corresponding value. `Name` must appear inside quotes. You can specify several name and value pair arguments in any order as `Name1, Value1, ..., NameN, ValueN`.

Example: `RGB = insertObjectMask(I,maskstack, 'LineColor','white','LineWidth',2);`

Color — Color of each mask

`lines(1)` (default) | RGB triplet | `ColorSpec`

Color of each mask, specified as the comma-separated pair consisting of `'Color'` and one of these values:

- P -by-3 matrix of RGB triplets, where P is the total number of masks
- P -element vector of MATLAB `ColorSpec` names
- 1-by-3 RGB triplet or scalar MATLAB `ColorSpec` name, specifying the color to use for all masks

Data Types: `single` | `double` | `int8` | `int16` | `int32` | `int64` | `uint8` | `uint16` | `uint32` | `uint64` | `logical` | `char` | `string`

Opacity — Opacity of mask

`0.6` (default) | scalar in the range `[0 1]`

Opacity of mask, specified as the comma separated pair consisting of `'Opacity'` and a scalar value in the range `[0 1]`. The value `1` makes the mask completely opaque and the value `0` makes the mask completely transparent.

Data Types: `single` | `double` | `int8` | `int16` | `int32` | `int64` | `uint8` | `uint16` | `uint32` | `uint64`

LineColor — Color of mask borders

`'auto'` (default) | RGB triplet | `ColorSpec`

Color of mask borders, specified as the comma separated pair consisting of `'LineColor'` and one of these values:

- `'auto'` — `'LineColor'` uses the same value or values as `'Color'`.
- P -by-3 matrix of RGB triplets, where P is the total number of masks
- P -element vector of MATLAB `ColorSpec` names
- 1-by-3 RGB triplet or scalar MATLAB `ColorSpec` name, specifying the color to use for all masks

Data Types: `single` | `double` | `int8` | `int16` | `int32` | `int64` | `uint8` | `uint16` | `uint32` | `uint64` | `logical` | `char` | `string`

LineOpacity — Opacity of mask borders

`1` (default) | `0`

Opacity of the mask borders, specified as the comma-separated pair consisting of `'LineOpacity'` and a scalar value in the range of `[0 1]`.

Data Types: `single` | `double` | `int8` | `int16` | `int32` | `int64` | `uint8` | `uint16` | `uint32` | `uint64`

LineWidth — Width of mask borders

1 (default) | positive scalar

Width of mask borders, specified as the comma-separated pair consisting of 'LineWidth' and a positive scalar. Specify 'LineWidth' in pixel units.

Data Types: `single` | `double` | `int8` | `int16` | `int32` | `int64` | `uint8` | `uint16` | `uint32` | `uint64`

Output Arguments

RGB — Output image

truecolor image

Output image, returned as a truecolor image of class `uint8`, with the same m -by- n dimensions as `I`.

Tips

- When masks overlap and the same pixel is in more than one mask, `maskstack(:, :, i)` takes precedence over `maskstack(:, :, j)`, where $i < j$.
- For better performance, set 'LineOpacity' to 0 to disable drawing the edges.

Extended Capabilities

C/C++ Code Generation

Generate C and C++ code using MATLAB® Coder™.

Usage notes and limitations:

- The value of the 'LineWidth' parameter must be a compile-time constant.
- The values of the 'Color' and 'LineColor' parameters must be numeric. The MATLAB ColorSpec is not supported with code generation.

See Also

`insertObjectAnnotation` | `insertShape` | `labeloverlay` | `showShape`

Topics

“Choose Function to Visualize Detected Objects”

Introduced in R2020b

insertShape

Insert shapes in image or video

Syntax

```
RGB = insertShape(I,shape,position)
RGB = insertShape( ____,Name,Value)
```

Description

`RGB = insertShape(I,shape,position)` returns a truecolor image with `shape` inserted. The input image, `I`, can be either a truecolor or grayscale image. You draw the shapes by overwriting pixel values.

`RGB = insertShape(____,Name,Value)` uses additional options specified by one or more `Name,Value` pair arguments.

Examples

Insert Circle and Filled Shapes on an Image

Read the image.

```
I = imread('peppers.png');
```

Draw a circle with a border line width of 5.

```
RGB = insertShape(I,'circle',[150 280 35],'LineWidth',5);
```

Draw a filled triangle and a filled hexagon.

```
pos_triangle = [183 297 302 250 316 297];
pos_hexagon = [340 163 305 186 303 257 334 294 362 255 361 191];
RGB = insertShape(RGB,'FilledPolygon',{pos_triangle,pos_hexagon},...
    'Color',{ 'white','green'},'Opacity',0.7);
```

Display the image.

```
imshow(RGB);
```



Input Arguments

I — Input image

M-by-*N*-by-3 truecolor | *M*-by-*N* 2-D grayscale image

Input image, specified in truecolor or 2-D grayscale.

Data Types: single | double | int16 | uint8 | uint16

shape — Type of shape

'Rectangle' | 'FilledRectangle' | 'Line' | 'Polygon' | 'FilledPolygon' | 'Circle' | 'FilledCircle'

Type of shape, specified as a character vector. The vector can be, 'Rectangle', 'FilledRectangle', 'Line', 'Polygon', 'FilledPolygon', 'Circle', or 'FilledCircle'.

Data Types: char

position — Position of shape

matrix | vector | cell array

Position of shape, specified according to the type of shape, described in the table.

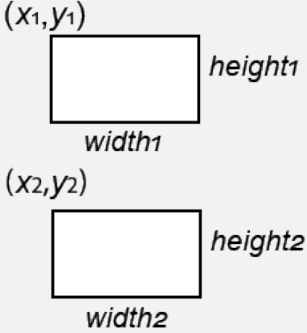
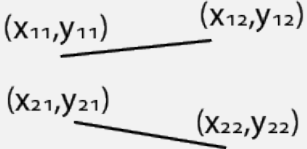
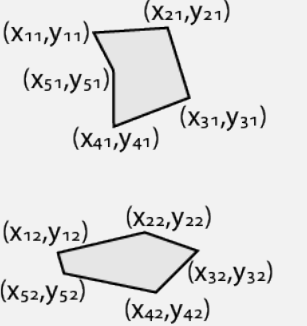
Shape	Position	Example
'Rectangle' 'FilledRectangle'	For one or more rectangles, specify M -by-4 matrix where each row specifies a rectangle as $[x\ y\ width\ height]$. $\begin{bmatrix} x_1 & y_1 & width_1 & height_1 \\ x_2 & y_2 & width_2 & height_2 \\ \vdots & \vdots & \vdots & \vdots \\ x_M & y_M & width_M & height_M \end{bmatrix}$	Two rectangles, $M=2$ 
'Line' 'Polygon' 'FilledPolygon'	For one or more disconnected lines, specify an M -by-4 matrix, where each four-element vector, $[x_1\ y_1\ x_2\ y_2]$, describes a line with endpoints. $\begin{bmatrix} x_{11} & y_{11} & x_{12} & y_{12} \\ x_{21} & y_{21} & x_{22} & y_{22} \\ \vdots & \vdots & \vdots & \vdots \\ x_{M1} & y_{M1} & x_{M2} & y_{M2} \end{bmatrix}$ <p>The polyline always contains $(L-1)$ number of segments because the first and last vertex points do not connect.</p>	Two lines, $M=2$ 
	For one or more polylines or polygons with the same number of vertices, specify an M -by- $2L$ matrix, where each row is a vector, $[x_1\ y_1\ x_2\ y_2\ \dots\ x_L\ y_L]$, of consecutive vertex locations, representing a polyline or a polygon with L number of vertices. $\begin{bmatrix} x_{11} & y_{11} & x_{12} & y_{12} & \dots & x_{1L} & y_{1L} \\ x_{21} & y_{21} & x_{22} & y_{22} & \dots & x_{2L} & y_{2L} \\ \vdots & \vdots & \vdots & \vdots & \ddots & \vdots & \vdots \\ x_{M1} & y_{M1} & x_{M2} & y_{M2} & \dots & x_{ML} & y_{ML} \end{bmatrix}$	Two polygons with equal number of vertices, $M=2, L=5$ 

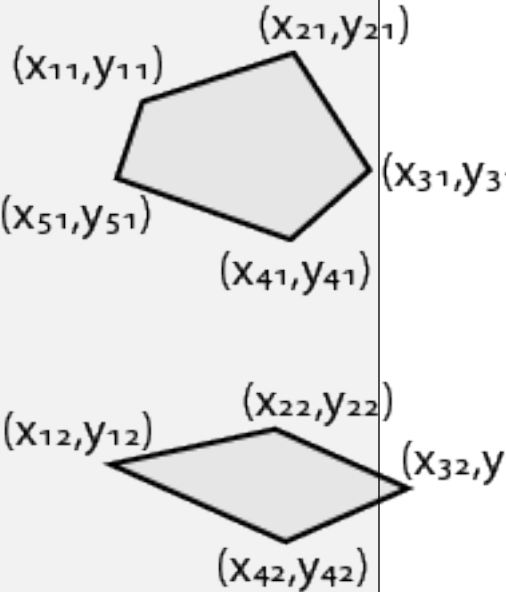
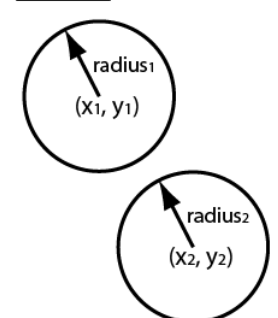
Shape	Position	Example
	<p>For one or more polylines or polygons with unequal number of vertices, specify an M-by-1 cell array, where each cell contains an L-by-2 matrix of $[x,y]$ vertices, or a 1-by-$2L$ vector, $[x_1 y_1 x_2 y_2 \dots x_L y_L]$, of consecutive vertex locations.</p> <p>The value of L can be different for each cell element. For example,</p> $\{[x_1 y_1 x_2 y_2], [x_1 y_1 x_2 y_2 x_3 y_3]\}$	<p>Two polygons with unequal number of vertices, $M=2$</p> 
'Circle' 'FilledCircle'	<p>An M-by-3 matrix, where each row is a vector specifying a circle as $[x y radius]$. The $[x y]$ coordinates represent the center of the circle.</p> $\begin{bmatrix} x_1 & y_1 & radius_1 \\ x_2 & y_2 & radius_2 \\ \vdots & \vdots & \vdots \\ x_M & y_M & radius_M \end{bmatrix}$	<p><u>For $M=2$:</u></p> 

Data Types: single | double | int8 | int16 | int32 | int64 | uint8 | uint16 | uint32 | uint64

Name-Value Pair Arguments

Specify optional comma-separated pairs of Name, Value arguments. Name is the argument name and Value is the corresponding value. Name must appear inside quotes. You can specify several name and value pair arguments in any order as Name1, Value1, ..., NameN, ValueN.

Example: 'Color', 'yellow' specifies yellow for the shape color.

LineWidth — Shape border line width

1 (default) | positive scalar integer

Shape border line width, specified in pixels, as a positive scalar integer. This property only applies to the 'Rectangle', 'Line', 'Polygon', or 'Circle' shapes.

Data Types: `uint8 | uint16 | int16 | double | single`

Color — Shape color

'yellow' (default) | character vector | cell array of character vectors | [R G B] vector | M -by-3 matrix

Shape color, specified as the comma-separated pair consisting of 'Color' and either a character vector, cell array of character vector, or matrix. You can specify a different color for each shape, or one color for all shapes.

To specify a color for each shape, set `Color` to a cell array of color character vectors or an M -by-3 matrix of M number of RGB (red, green, and blue) color values.

To specify one color for all shapes, set `Color` to either a color character vector or an [R G B] vector. The [R G B] vector contains the red, green, and blue values.

Supported colors: 'blue', 'green', 'red', 'cyan', 'magenta', 'black', 'black', and 'white'.

Data Types: `cell | char | uint8 | uint16 | int16 | double | single`

Opacity — Opacity of filled shape

0.6 (default) | range of [0 1]

Opacity of filled shape, specified as the comma-separated pair consisting of 'Opacity' and a scalar value in the range [0 1]. The `Opacity` property applies for the `FilledRectangle`, `FilledPolygon`, and `FilledCircle` shapes.

Data Types: `double | single | int8 | int16 | int32 | int64 | uint8 | uint16 | uint32 | uint64`

SmoothEdges — Smooth shape edges

true (default) | false

Smooth shape edges, specified as the comma-separated pair consisting of 'SmoothEdges' and a logical value of true or false. A true value enables an anti-aliasing filter to smooth shape edges. This value applies only to nonrectangular shapes. Enabling anti-aliasing requires additional time to draw the shapes.

Data Types: `logical`

Output Arguments

RGB — Output image

M -by- N -by-3 truecolor

Output image, returned as a truecolor image.

Extended Capabilities

C/C++ Code Generation

Generate C and C++ code using MATLAB® Coder™.

- 'Color' and 'SmoothEdges' must be compile-time constants.

See Also

[showShape](#) | [insertObjectAnnotation](#) | [insertObjectMask](#) | [insertMarker](#) | [insertText](#)

Topics

“Draw Markers on an Image” on page 3-637

“Insert Numbers and Text on Image” on page 3-658

“Choose Function to Visualize Detected Objects”

Introduced in R2014a

insertText

Insert text in image or video

Syntax

```
RGB = insertText(I,position,text)
RGB = insertText(I,position,numericValue)
RGB = insertText( ____,Name,Value)
```

Description

`RGB = insertText(I,position,text)` returns a truecolor image with `text` inserted. The input image, `I`, can be either a truecolor or grayscale image.

`RGB = insertText(I,position,numericValue)` returns a truecolor image with numeric values inserted.

`RGB = insertText(____,Name,Value)` uses additional options specified by one or more `Name,Value` pair arguments.

Examples

Insert Numbers and Text on Image

Read the image.

```
I = imread('board.tif');
```

Create texts that contain fractions.

```
text_str = cell(3,1);
conf_val = [85.212 98.76 78.342];
for ii=1:3
    text_str{ii} = ['Confidence: ' num2str(conf_val(ii),'%0.2f') '%'];
end
```

Define the positions and colors of the text boxes.

```
position = [23 373;35 185;77 107];
box_color = {'red','green','yellow'};
```

Insert the text with new font size, box color, opacity, and text color.

```
RGB = insertText(I,position,text_str,'FontSize',18,'BoxColor',...
    box_color,'BoxOpacity',0.4,'TextColor','white');
```

Display the image.

```
figure
imshow(RGB)
title('Board');
```

Board

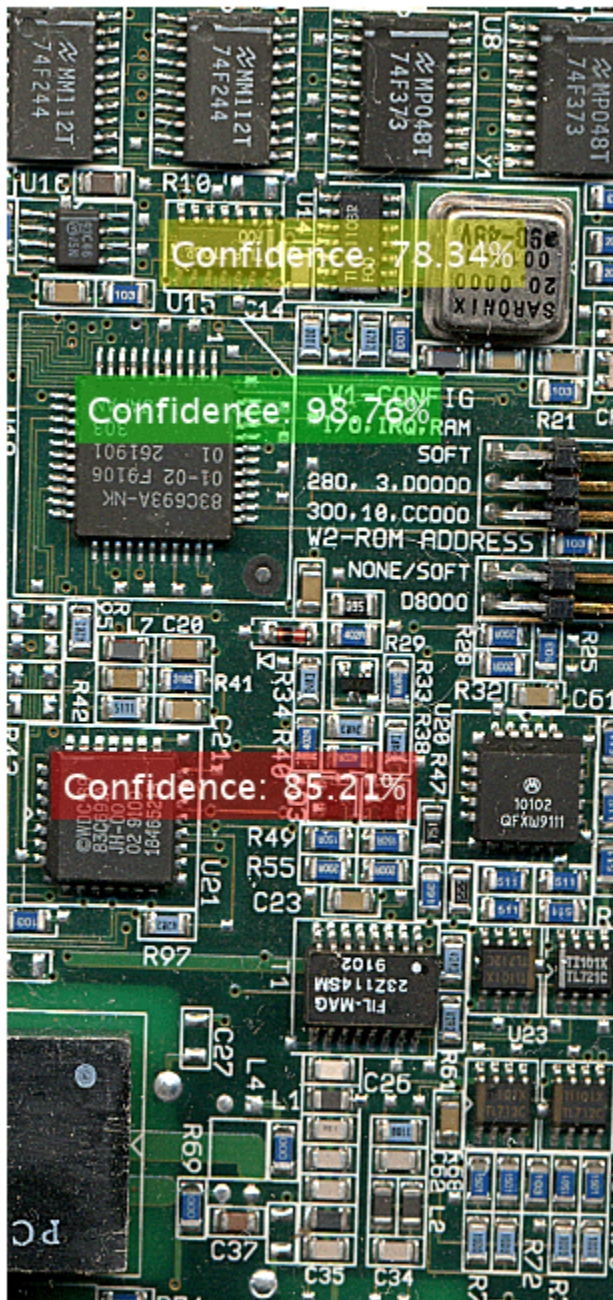

Insert Numeric Text on Image

Read the image.

```
I = imread('peppers.png');
```

Define the (x, y_) position for the text and the value.

```
position = [1 50; 100 50];  
value = [555 pi];
```

Insert text using the bottom-left as the anchor point.

```
RGB = insertText(I,position,value,'AnchorPoint','LeftBottom');
```

Display the image with the numeric text inserted.

```
figure  
imshow(RGB),title('Numeric values');
```

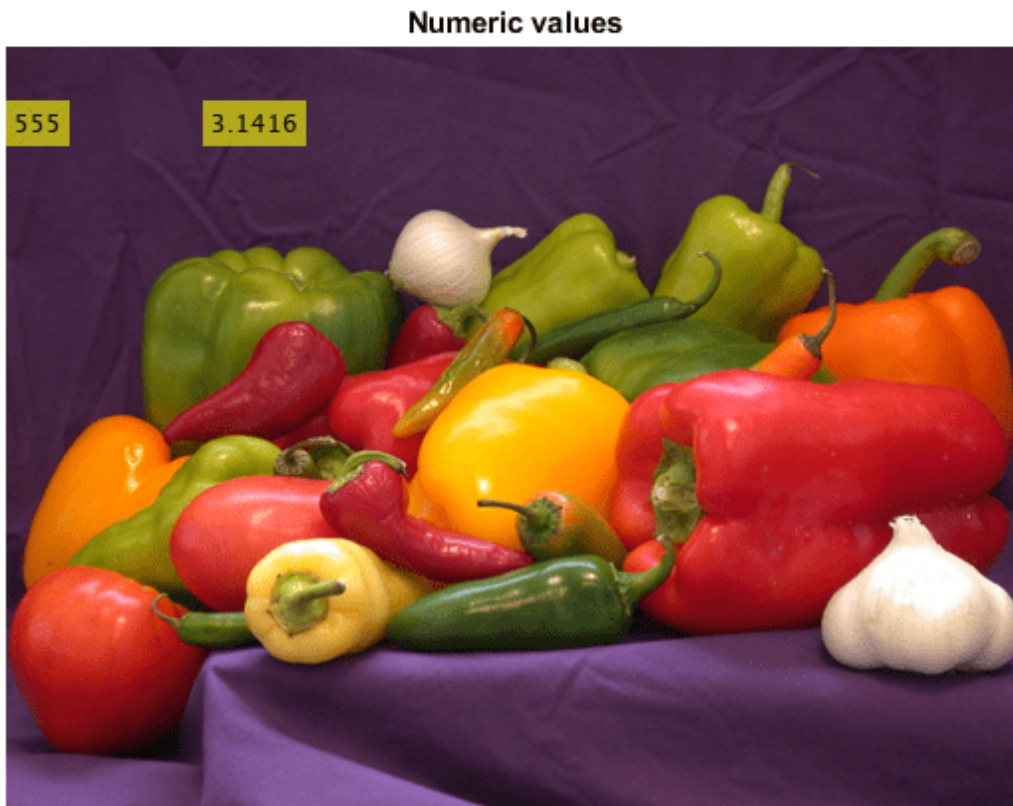

Display non-ASCII character (U+014C)

```
OWithMacron=native2unicode([hex2dec('C5') hex2dec('8C')], 'UTF-8');  
RGB = insertText(RGB,[256 50],OWithMacron,'Font','LucidaSansRegular','BoxColor','w');
```

Display the image with the numeric text inserted.

```
figure  
imshow(IMG),title('Numeric values');
```

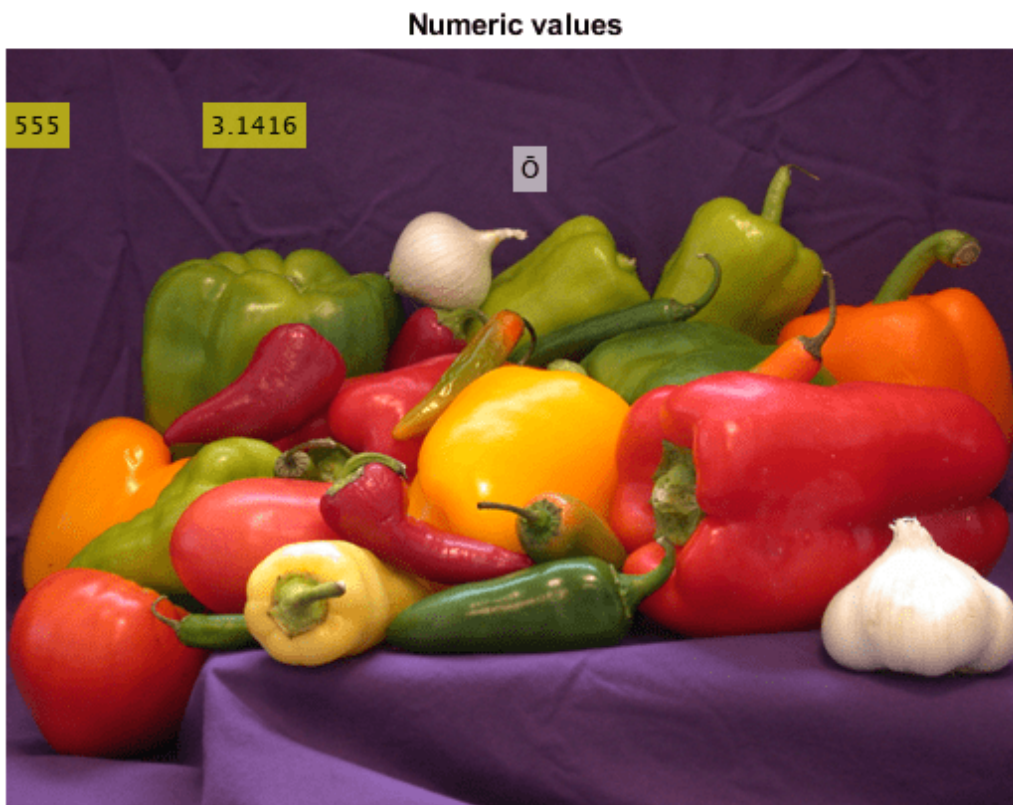

Input Arguments

I — Input image

M-by-*N*-by-3 truecolor | *M*-by-*N* 2-D grayscale image

Input image, specified as *M*-by-*N*-by-3 truecolor image or an *M*-by-*N* 2-D grayscale image.

Data Types: single | double | int16 | uint8 | uint16

text — Unicode text character vector

character vector | string scalar | cell array of character vectors | string array

Unicode text, specified as a single UNICODE text string or a cell array of UNICODE strings of length *M*, where *M* is the number of rows in `position`. The function overwrites pixels with the value of `text`. The length of the cell array must equal the number of rows in the `position` matrix. If you specify a single string, the function uses it for all positions in the `position` matrix. Most unicode

fonts contain ASCII characters. You can display non-English and English characters, including English numeric values, with a single font.

Data Types: `single` | `double` | `int8` | `int16` | `int32` | `int64` | `uint8` | `uint16` | `uint32` | `uint64`

numericValue — Numeric value text

`scalar` | `vector`

Numeric value text, specified as a scalar or a vector. If you specify a scalar value, that value is used for all positions. The vector length must equal the number of rows in the `position` matrix. Numeric values are converted to a character vector using the `sprintf` format `'%0.5g'`.

Data Types: `char`

position — Position of inserted text

`vector` | `matrix`

Position of inserted text, specified as a vector or an M -by-2 matrix of $[x\ y]$ coordinates. Each row represents the $[x\ y]$ coordinate for the `AnchorPoint` of the text bounding box.

Data Types: `single` | `double` | `int8` | `int16` | `int32` | `int64` | `uint8` | `uint16` | `uint32` | `uint64`

Name-Value Pair Arguments

Specify optional comma-separated pairs of `Name`, `Value` arguments. `Name` is the argument name and `Value` is the corresponding value. `Name` must appear inside quotes. You can specify several name and value pair arguments in any order as `Name1`, `Value1`, `...`, `NameN`, `ValueN`.

Example: `'AnchorPoint','LeftTop'`

Font — Font face of text

`'LucidaSansRegular'` (default) | character vector

Font face of text, specified as the comma-separated pair consisting of `'Font'` and a character vector. The font face must be one of the available truetype fonts installed on your system. To get a list of available fonts on your system, type `listTrueTypeFonts` at the MATLAB command prompt.

Data Types: `char`

FontSize — Font size

12 (default) | positive integer in the range [1,200]

Font size, specified as the comma-separated pair consisting of `'FontSize'` and a positive integer in the range [1,200].

Data Types: `double` | `single` | `int8` | `int16` | `int32` | `int64` | `uint8` | `uint16` | `uint32` | `uint64`

TextColor — Text color

`'black'` (default) | character vector | cell array of character vectors | [R G B] vector | M -by-3 matrix

Text color, specified as the comma-separated pair consisting of `'TextColor'` and a character vector, cell array of character vectors, or matrix. You can specify a different color for each character vector or one color for all character vectors.

- To specify a color for each text character vector, set `TextColor` to a cell array of M number of color character vectors. Or, you can set it to an M -by-3 matrix of RGB character vector color values.

- To specify one color for all text character vectors, set `TextColor` to either a color character vector or an [R G B] vector of red, green, and blue values.
- RGB values must be in the range of the image data type. Supported colors: 'blue', 'green', 'red', 'cyan', 'magenta', 'yellow', 'black', and 'white'.

Data Types: cell | char | uint8 | uint16 | int16 | double | single

BoxColor — Text box color

'yellow' (default) | character vector | cell array of character vectors | [R G B] vector | *M*-by-3 matrix

Text box color, specified as the comma-separated pair consisting of 'BoxColor' and a character vector, cell array of character vector, or matrix. You can specify a different color for each text box or one color for all the boxes.

- To specify a color for each text box, set `BoxColor` to a cell array of *M* number of color character vectors. Or, you can set it to an *M*-by-3 matrix of *M* number of RGB (red, green, and blue) character vector color values.
- To specify one color for all the text boxes, set `BoxColor` to either a color character vector or an [R G B] vector. The [R G B] vector contains the red, green, and blue values.
- RGB values must be in the range of the image data type. Supported colors: 'blue', 'green', 'red', 'cyan', 'magenta', 'yellow', 'black', and 'white'.

Data Types: cell | char | uint8 | uint16 | int16 | double | single

BoxOpacity — Opacity of text box

0.6 (default) | scalar value in the range of [0 1]

Opacity of text box, specified as the comma-separated pair consisting of 'BoxOpacity' and a scalar value in the range [0,1]. A value of 0 corresponds to a fully transparent text box, or no box. A value of 1 corresponds to a fully opaque text box.

Data Types: double | single | int8 | int16 | int32 | int64 | uint8 | uint16 | uint32 | uint64

AnchorPoint — Text box reference point

'LeftTop' (default) | 'LeftCenter' | 'LeftBottom' | 'CenterTop' | 'Center' | 'CenterBottom' | 'RightTop' | 'RightCenter' | 'RightBottom'

Text box reference point, specified as the comma-separated pair consisting of 'AnchorPoint' and a character vector value. The anchor point defines a relative location on the text box. You can position the text box by placing its anchor point at the [x,y] coordinate defined by the corresponding position for the text. For example, to place the center of the text box to be at the [x,y] coordinate you specified with the `position` input, then set `AnchorPoint` to `Center`.

Supported positions are `LeftTop`, `LeftCenter`, `LeftBottom`, `CenterTop`, `Center`, `CenterBottom`, `RightTop`, `RightCenter`, and `RightBottom`.

Data Types: char

Output Arguments

RGB — Output image

M-by-*N*-by-3 truecolor image

Output image, returned as an *M*-by-*N*-by-3 truecolor image with the specified text inserted.

Limitations

- If you do not see characters in the output image, it means that the font did not contain the character. Select a different font. To get a list of available fonts on your system, at the MATLAB prompt, type `listTrueTypeFonts`.
- Increasing the font size also increases the preprocessing time and memory usage.
- The `insertText` function does not work for certain composite characters. For example, you cannot insert text when the rendering of one glyph corresponding to a character code influences the position, shape, or size of the adjacent glyph.

Extended Capabilities

C/C++ Code Generation

Generate C and C++ code using MATLAB® Coder™.

Usage notes and limitations:

- `Font`, `FontSize` must be compile-time constants.
- Non-ASCII characters are not supported.

See Also

`insertObjectAnnotation` | `insertMarker` | `insertShape` | `listTrueTypeFonts`

Topics

“Draw Markers on an Image” on page 3-637

“Insert Circle and Filled Shapes on an Image” on page 3-652

“Choose Function to Visualize Detected Objects”

Introduced in R2013a

isEpipoleInImage

Determine whether image contains epipole

Syntax

```
isIn = isEpipoleInImage(F,imageSize)
isIn = isEpipoleInImage(F',imageSize)
[isIn,epipole] = isEpipoleInImage( __ )
```

Description

`isIn = isEpipoleInImage(F,imageSize)` determines whether the first stereo image associated with the fundamental matrix F contains an epipole. `imageSize` is the size of the first image, and is in the format returned by the function `size`.

`isIn = isEpipoleInImage(F',imageSize)` determines whether the second stereo image associated with the fundamental matrix F' contains an epipole.

`[isIn,epipole] = isEpipoleInImage(__)` also returns the epipole.

Examples

Determine Epipole Location in an Image

```
% Load stereo point pairs.
load stereoPointPairs
f = estimateFundamentalMatrix(matchedPoints1, matchedPoints2, 'NumTrials', 2000);
imageSize = [200 300];

% Determine whether the image contains epipole and epipole location.
[isIn,epipole] = isEpipoleInImage(f,imageSize)

isIn = logical
      1

epipole = 1x2

      256.5465   100.0140
```

Input Arguments

F — Fundamental matrix

3-by-3 matrix (default)

Fundamental matrix, specified as a 3-by-3 matrix computed from stereo images. F must be double or single. If P_1 represents a point in the first image I_1 that corresponds to P_2 , a point in the second image I_2 , then:

$$[P_2,1] * F * [P_1,1]' = 0$$

In computer vision, the fundamental matrix is a 3-by-3 matrix which relates corresponding points in stereo images. When two cameras view a 3-D scene from two distinct positions, there are a number of geometric relations between the 3-D points and their projections onto the 2-D images that lead to constraints between the image points. Two images of the same scene are related by epipolar geometry.

imageSize — Image size

row vector

Image size, specified in the format returned by the `size` function.

Output Arguments

isIn — Valid epipole

logical

Valid epipole logical, specified as `true` when the image contains an epipole, and `false` when the image does not contain an epipole.

When the image planes are at a great enough angle to each other, you can expect the epipole to be located in the image.

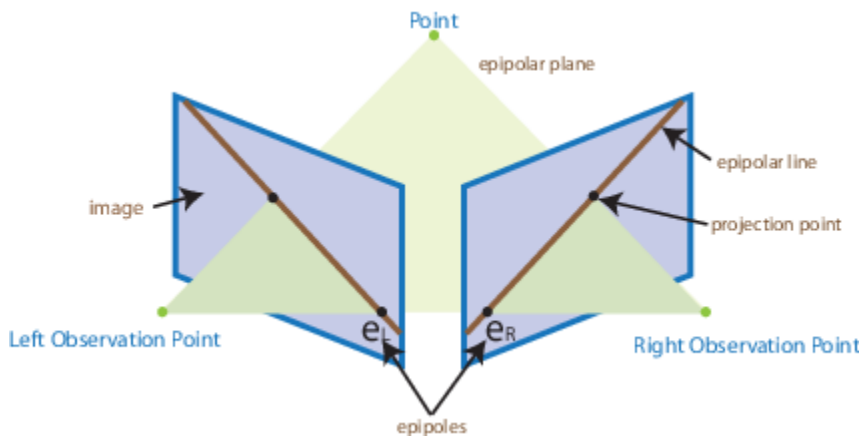

When the image planes are at a more subtle angle to each other, you can expect the epipole to be located outside of the image, (but still in the image plane).

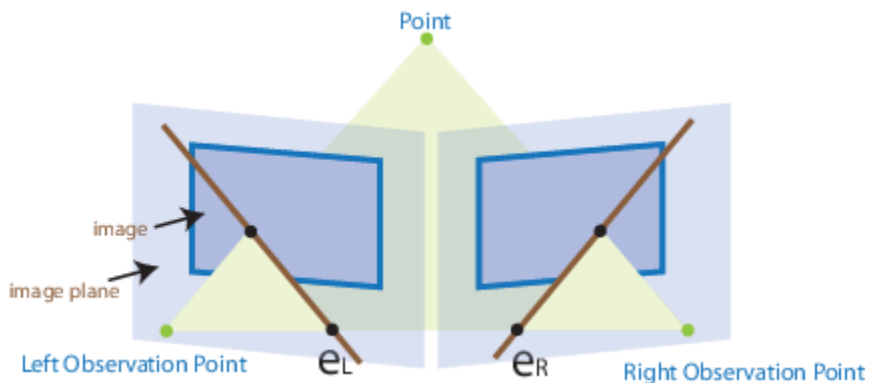

epipole — Location of epipole

1-by-2 vector

Location of epipole, returned as a 1-by-2 vector.

Extended Capabilities**C/C++ Code Generation**

Generate C and C++ code using MATLAB® Coder™.

See Also

[estimateFundamentalMatrix](#) | [epipolarLine](#) | [estimateUncalibratedRectification](#)

Topics

“Structure From Motion From Two Views”

“Structure From Motion From Multiple Views”

Introduced in R2011a

isfilterseparable

Determine whether filter coefficients are separable

Syntax

```
isSeparable = isfilterseparable(H)  
[isSeparable,hcol,hrow] = isfilterseparable(H)
```

Description

`isSeparable = isfilterseparable(H)` returns logical 1 (true) when the filter kernel `H` is separable, and 0 (false) otherwise.

`[isSeparable,hcol,hrow] = isfilterseparable(H)` also returns the vertical coefficients `hcol` and horizontal coefficients `hrow` when the filter kernel, `H`, is separable. Otherwise, `hcol` and `hrow` are empty.

Examples

Determine if Gaussian Filter is Separable

Determine if the Gaussian filter created using the `fspecial` function is separable.

Create a Gaussian filter.

```
twoDimensionalFilter = fspecial('gauss');
```

Test the filter.

```
[isseparable,hcol,hrow] = isfilterseparable(twoDimensionalFilter)
```

```
isseparable = logical  
             1
```

```
hcol = 3×1
```

```
    -0.1065  
    -0.7870  
    -0.1065
```

```
hrow = 1×3
```

```
    -0.1065    -0.7870    -0.1065
```

Input Arguments

H — Filter kernel

2-D numeric matrix | 2-D logical matrix

Filter kernel, specified as a non-sparse 2-D numeric or logical matrix.

Output Arguments

isSeparable — Filter is separable

1 (true) | 0 (false)

Filter is separable, returned as logical 1 (true) when the filter is separable and 0 (false) when the filter is not separable.

Data Types: `logical`

hcol — Vertical coefficients

numeric vector | []

Vertical coefficients when the filter kernel H is separable, returned as a numeric vector. When H is not separable, hcol is empty. If H is of data type `single`, then hcol is also of data type `single`. Otherwise, hcol is of data type `double`.

hrow — Horizontal coefficients

numeric vector | []

Horizontal coefficients when the filter kernel H is separable, returned as a numeric vector. When H is not separable, hrow is empty. If H is of data type `single`, then hrow is also of data type `single`. Otherwise, hrow is of data type `double`.

More About

Separable two dimensional filters

Separable two-dimensional filters reflect the outer product of two vectors. Separable filters help reduce the number of calculations required.

A two-dimensional convolution calculation requires a number of multiplications equal to the *width* × *height* for each output pixel. The general case equation for a two-dimensional convolution is:

$$Y(m, n) = \sum_k \sum_l H(k, l) U(m - k, n - l)$$

If the filter H is separable then,

$$H(k, l) = H_{row}(k) H_{col}(l)$$

Shifting the filter instead of the image, the two-dimensional equation becomes:

$$Y(m, n) = \sum_k H_{row}(k) \sum_l H_{col}(l) U(m - k, n - l)$$

This calculation requires only (width + height) number of multiplications for each pixel.

Algorithms

The `isfilterseparable` function uses the singular value decomposition `svd` function to determine the rank of the matrix.

See Also

2-D FIR Filter | `svd` | `rank`

External Websites

MATLAB Central — Separable Convolution

Introduced in R2006a

lineToBorderPoints

Intersection points of lines in image and image border

Syntax

```
points = lineToBorderPoints(lines,imageSize)
```

Description

`points = lineToBorderPoints(lines,imageSize)` computes the intersection points between one or more lines in an image with the image border.

Examples

Find Intersection Points Between a Line and Image Border

Load and display an image.

```
I = imread('rice.png');  
figure;  
imshow(I);  
hold on;
```

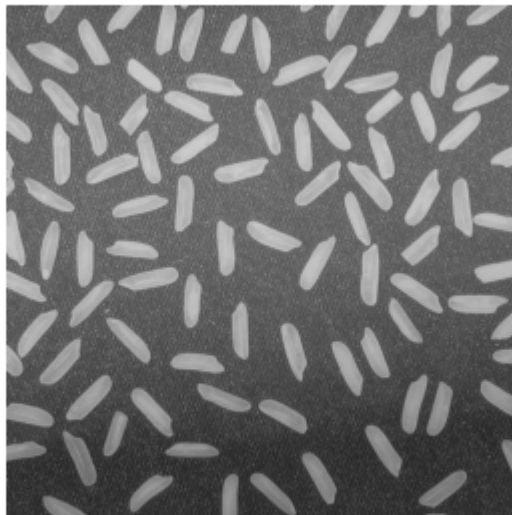

Define a line with the equation, $2 * x + y - 300 = 0$.

```
aLine = [2,1,-300];
```

Compute the intersection points of the line and the image border.

```
points = lineToBorderPoints(aLine,size(I))
```

```
points = 1×4
```

```
149.7500 0.5000 21.7500 256.5000
```

```
line(points([1,3]),points([2,4]));
```

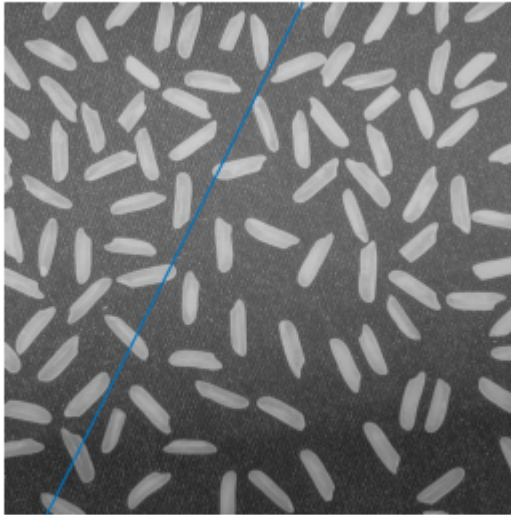

Input Arguments

lines — Line matrix

M-by-3 matrix (default)

Line matrix, specified as an *M*-by-3 matrix, where each row must be in the format, $[A,B,C]$. This matrix corresponds to the definition of the line:

$$A * x + B * y + C = 0.$$

M represents the number of lines.

lines must be double or single.

imageSize — Image size

integer (default) | row vector

Image size, specified as a row vector in the format returned by the `size` function.

Output Arguments

points — Intersection points

M-by-4 matrix

Intersection points, returned as an *M*-by-4 matrix. The function returns the matrix in the format of $[x_1, y_1, x_2, y_2]$. In this matrix, $[x_1, y_1]$ and $[x_2, y_2]$ are the two intersection points. When a line in the image and the image border do not intersect, the function returns $[-1, -1, -1, -1]$.

Extended Capabilities

C/C++ Code Generation

Generate C and C++ code using MATLAB® Coder™.

See Also

[size](#) | [line](#) | [epipolarLine](#)

Introduced in R2011a

matchFeatures

Find matching features

Syntax

```
indexPairs = matchFeatures(features1, features2)
[indexPairs, matchmetric] = matchFeatures(features1, features2)
[indexPairs, matchmetric] = matchFeatures(features1, features2, Name, Value)
```

Description

`indexPairs = matchFeatures(features1, features2)` returns indices of the matching features in the two input feature sets. The input feature must be either `binaryFeatures` objects or matrices.

`[indexPairs, matchmetric] = matchFeatures(features1, features2)` also returns the distance between the matching features, indexed by `indexPairs`.

`[indexPairs, matchmetric] = matchFeatures(features1, features2, Name, Value)` includes additional options specified by one or more `Name, Value` pair arguments.

Examples

Find Corresponding Interest Points Between Pair of Images

Find corresponding interest points between a pair of images using local neighborhoods and the Harris algorithm.

Read the stereo images.

```
I1 = im2gray(imread('viprectification_deskLeft.png'));
I2 = im2gray(imread('viprectification_deskRight.png'));
```

Find the corners.

```
points1 = detectHarrisFeatures(I1);
points2 = detectHarrisFeatures(I2);
```

Extract the neighborhood features.

```
[features1, valid_points1] = extractFeatures(I1, points1);
[features2, valid_points2] = extractFeatures(I2, points2);
```

Match the features.

```
indexPairs = matchFeatures(features1, features2);
```

Retrieve the locations of the corresponding points for each image.

```
matchedPoints1 = valid_points1(indexPairs(:,1),:);
matchedPoints2 = valid_points2(indexPairs(:,2),:);
```

Visualize the corresponding points. You can see the effect of translation between the two images despite several erroneous matches.

```
figure;
showMatchedFeatures(I1,I2,matchedPoints1,matchedPoints2);
```

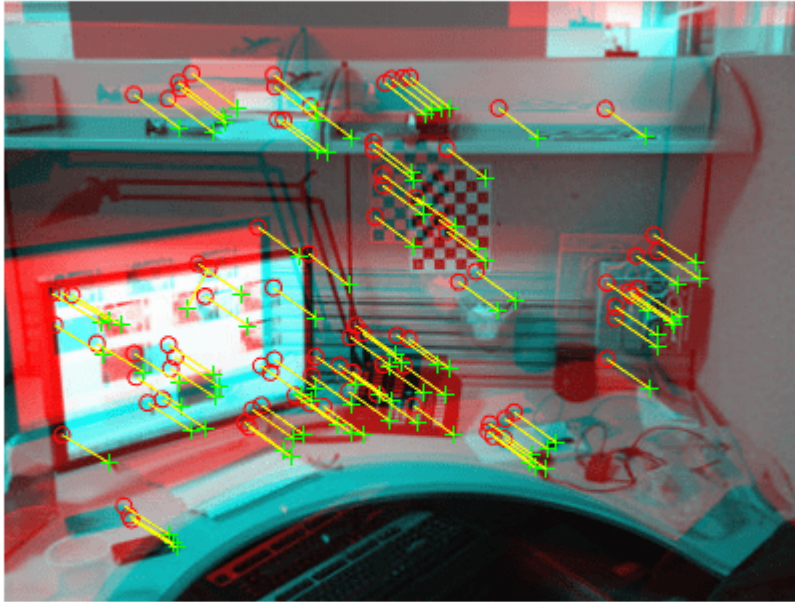

Find Corresponding Points Using SURF Features

Use the SURF local feature detector function to find the corresponding points between two images that are rotated and scaled with respect to each other.

Read the two images.

```
I1 = imread('cameraman.tif');
I2 = imresize(imrotate(I1,-20),1.2);
```

Find the SURF features.

```
points1 = detectSURFFeatures(I1);
points2 = detectSURFFeatures(I2);
```

Extract the features.

```
[f1,vpts1] = extractFeatures(I1,points1);
[f2,vpts2] = extractFeatures(I2,points2);
```

Retrieve the locations of matched points.

```
indexPairs = matchFeatures(f1,f2) ;
matchedPoints1 = vpts1(indexPairs(:,1));
matchedPoints2 = vpts2(indexPairs(:,2));
```

Display the matching points. The data still includes several outliers, but you can see the effects of rotation and scaling on the display of matched features.

```
figure; showMatchedFeatures(I1,I2,matchedPoints1,matchedPoints2);
legend('matched points 1','matched points 2');
```



Input Arguments

features1 — Feature set 1

binaryFeatures object | M_1 -by- N matrix

Features set 1, specified as a binaryFeatures object or an M_1 -by- N matrix. The matrix contains M_1 features, and N corresponds to the length of each feature vector. You can obtain the binaryFeatures object using the extractFeatures function with the fast retina keypoint (FREAK), Oriented FAST and Rotated BRIEF (ORB), or binary robust invariant scalable keypoints (BRISK) descriptor method.

features2 — Feature set 2*M*₂-by-*N* matrix | `binaryFeatures` object

Features set 2, specified as a `binaryFeatures` object or an *M*₂-by-*N* matrix. The matrix contains *M*₂ features and *N* corresponds to the length of each feature vector. You can obtain the `binaryFeatures` object using the `extractFeatures` function with the fast retina keypoint (FREAK), Oriented FAST and Rotated BRIEF (ORB), or binary robust invariant scalable keypoints (BRISK) descriptor method.

Name-Value Pair Arguments

Specify optional comma-separated pairs of `Name`, `Value` arguments. `Name` is the argument name and `Value` is the corresponding value. `Name` must appear inside quotes. You can specify several name and value pair arguments in any order as `Name1`, `Value1`, . . . , `NameN`, `ValueN`.

Example: `'Metric', 'SSD'` specifies the sum of squared differences for the feature matching metric.

Method — Matching method`'Exhaustive'` (default) | `'Approximate'`

Matching method, specified as the comma-separated pair consisting of `'Method'` and either `'Exhaustive'` or `'Approximate'`. The method specifies how nearest neighbors between `features1` and `features2` are found. Two feature vectors match when the distance between them is less than the threshold set by the `MatchThreshold` parameter.

`'Exhaustive'` Compute the pairwise distance between feature vectors in `features1` and `features2`.

`'Approximate'` Use an efficient approximate nearest neighbor search. Use this method for large feature sets. [3]

MatchThreshold — Matching threshold`10.0` or `1.0` (default) | percent value in the range (0, 100]

Matching threshold, specified as the comma-separated pair consisting of `'MatchThreshold'` and a scalar percent value in the range (0,100]. The default values are set to either `10.0` for binary feature vectors or to `1.0` for nonbinary feature vectors. You can use the match threshold for selecting the strongest matches. The threshold represents a percent of the distance from a perfect match.

Two feature vectors match when the distance between them is less than the threshold set by `MatchThreshold`. The function rejects a match when the distance between the features is greater than the value of `MatchThreshold`. Increase the value to return more matches.

Inputs that are `binaryFeatures` objects typically require a larger value for the match threshold. The `extractFeatures` function returns the `binaryFeatures` objects when extracting FREAK, ORB, or BRISK descriptors.

MaxRatio — Ratio threshold`0.6` (default) | ratio in the range (0,1]

Ratio threshold, specified as the comma-separated pair consisting of `'MaxRatio'` and a scalar ratio value in the range (0,1]. Use the max ratio for rejecting ambiguous matches. Increase this value to return more matches.

Metric — Feature matching metric`'SSD'` (default) | `'SAD'`

Feature matching metric, specified as the comma-separated pair consisting of 'Metric' and either 'SAD' or 'SSD'.

'SAD' Sum of absolute differences

'SSD' Sum of squared differences

This property applies when the input feature sets, `features1` and `features2`, are not `binaryFeatures` objects. When you specify the features as `binaryFeatures` objects, the function uses the Hamming distance to compute the similarity metric.

Unique – Unique matches

`false` (default) | `true`

Unique matches, specified as the comma-separated pair consisting of 'Unique' and either `false` or `true`. Set this value to `true` to return only unique matches between `features1` and `features2`.

When you set `Unique` to `false`, the function returns all matches between `features1` and `features2`. Multiple features in `features1` can match to one feature in `features2`.

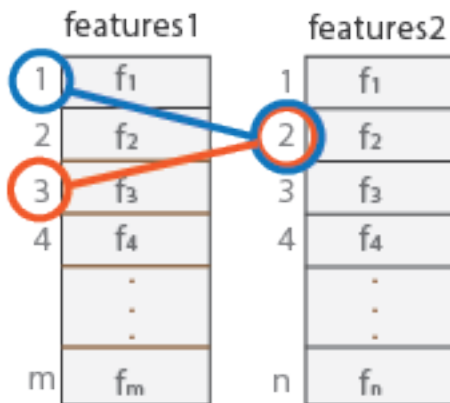

When you set `Unique` to `true`, the function performs a forward-backward match to select a unique match. After matching `features1` to `features2`, it matches `features2` to `features1` and keeps the best match.

Output Arguments

indexPairs – Indices to corresponding features

P-by-2 matrix

Indices of corresponding features between the two input feature sets, returned as a *P*-by-2 matrix of *P* number of indices. Each index pair corresponds to a matched feature between the `features1` and `features2` inputs. The first element indexes the feature in `features1`. The second element indexes the matching feature in `features2`.

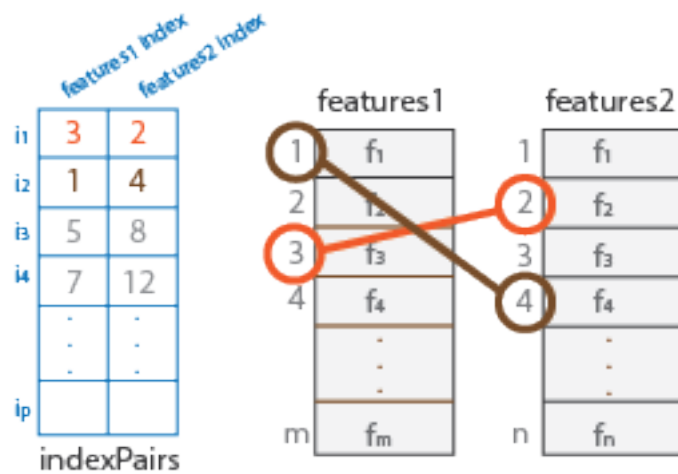

matchmetric – Distance between matching features

p -by-1 vector

Distance between matching features, returned as a p -by-1 vector. The value of the distances are based on the metric selected. Each i th element in `matchmetric` corresponds to the i th row in the `indexPairs` output matrix. When `Metric` is set to either `SAD` or `SSD`, the feature vectors are normalized to unit vectors before computation.

Metric	Range	Perfect Match Value
SAD	$[0, 2 \cdot \sqrt{\text{size}(\text{features1}, 2)}]$	0
SSD	$[0, 4]$	0
Hamming	$[0, \text{features1.NumBits}]$	0

References

- [1] Lowe, David G. "Distinctive Image Features from Scale-Invariant Keypoints." *International Journal of Computer Vision*. Volume 60, Number 2, pp. 91-110.
- [2] Muja, M., and D. G. Lowe. "Fast Matching of Binary Features." *Conference on Computer and Robot Vision*. CRV, 2012.
- [3] Muja, M., and D. G. Lowe. "Fast Approximate Nearest Neighbors with Automatic Algorithm Configuration." *International Conference on Computer Vision Theory and Applications*. VISAPP, 2009.
- [4] Rublee, E., V. Rabaud, K. Konolige and G. Bradski. "ORB: An efficient alternative to SIFT or SURF." In *Proceedings of the 2011 International Conference on Computer Vision*, 2564-2571. Barcelona, Spain, 2011.

Extended Capabilities

C/C++ Code Generation

Generate C and C++ code using MATLAB® Coder™.

Usage notes and limitations:

- Generates platform-dependent library for MATLAB host only when using the `Exhaustive` method.
- Generates portable C code for non-host target only when using the `Exhaustive` method.
- Generates portable C code using a C++ compiler that links to OpenCV (Version 3.4.0) libraries when not using the `Exhaustive` method. See “Portable C Code Generation for Functions That Use OpenCV Library”.
- 'Method' and 'Metric' must be compile-time constants.

GPU Code Generation

Generate CUDA® code for NVIDIA® GPUs using GPU Coder™.

Usage notes and limitations:

- CUDA code is generated only for the `exhaustive` matching method. If the `Approximate` method is selected, GPU Coder issues a warning and generates C/C++ code for this function.

See Also

`showMatchedFeatures` | `extractFeatures` | `binaryFeatures` | `detectHarrisFeatures` | `detectMSERFeatures` | `detectSURFFeatures` | `detectORBFeatures` | `detectBRISKFeatures` | `detectFASTFeatures` | `detectMinEigenFeatures` | `estimateFundamentalMatrix` | `estimateGeometricTransform`

Topics

“Structure from Motion Overview”

Introduced in R2011a

matchFeaturesInRadius

Find matching features within specified radius

Syntax

```
indexPairs = matchFeaturesInRadius(features1, features2, points2, centerPoints,
radius)
[indexPairs, matchMetric] = matchFeaturesInRadius( ___ )
[indexPairs, matchMetric] = matchFeaturesInRadius( ___, Name, Value)
```

Description

`indexPairs = matchFeaturesInRadius(features1, features2, points2, centerPoints, radius)` returns the indices of the features most likely to correspond between the input feature sets within the specified radius or radii around each expected match location.

`[indexPairs, matchMetric] = matchFeaturesInRadius(___)` also returns the distance between the features in a matched pair in `indexPairs`.

`[indexPairs, matchMetric] = matchFeaturesInRadius(___, Name, Value)` specifies options using one or more name-value arguments in addition of the input arguments in previous syntaxes.

Examples

Match Features Between Two Images

Load a MAT file containing an image and camera data into the workspace.

```
data = load('matchInRadiusData.mat');
```

Convert the camera pose to extrinsics.

```
orientation = data.cameraPose2.Rotation;
location = data.cameraPose2.Translation;
[rotationMatrix, translationVector] = cameraPoseToExtrinsics(orientation, location);
```

Project the 3-D world points associated with feature set one onto the second image.

```
centerPoints = worldToImage(data.intrinsics, rotationMatrix, translationVector, data.worldPoints);
```

Match features between the two feature sets within spatial constraints.

```
indexPairs1 = matchFeaturesInRadius(data.features1, data.features2, ...
    data.points2, centerPoints, data.radius, 'MatchThreshold', 40, ...
    'MaxRatio', 0.9);
```

Match features between the two feature sets without using spatial constraints.

```
indexPairs2 = matchFeatures(data.features1, data.features2, ...
    'MatchThreshold', 40, 'MaxRatio', 0.9);
```

Visualize and compare the results between the two ways of matching features.

```
figure
subplot(2,1,1)
showMatchedFeatures(data.I1,data.I2,data.points1( ...
    indexPairs1(:,1)),data.points2(indexPairs1(:,2)));
title(sprintf('%d pairs matched with spatial constraints',size(indexPairs1,1)));

subplot(2,1,2)
showMatchedFeatures(data.I1,data.I2,data.points1( ...
    indexPairs2(:,1)),data.points2(indexPairs2(:,2)));
title(sprintf('%d pairs matched without spatial constraints',size(indexPairs2,1)));
```

144 pairs matched with spatial constraints

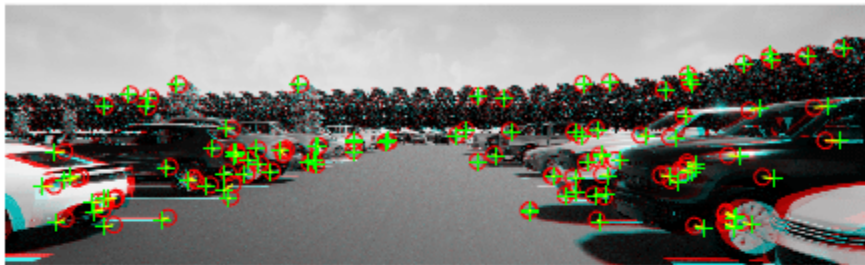

130 pairs matched without spatial constraints

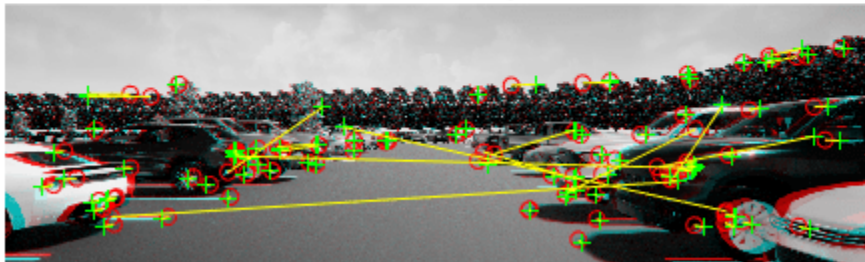

Input Arguments

features1 — Feature set one

binaryFeatures object | $M1$ -by- N matrix

Feature set one, specified as a `binaryFeatures` object or an $M1$ -by- N matrix. The matrix contains $M1$ features, and N corresponds to the length of each feature vector.

You can obtain the `binaryFeatures` object using the `extractFeatures` function with the fast retina keypoint (FREAK), oriented fast and rotated brief (ORB), or binary robust invariant scalable keypoints (BRISK) descriptor method.

Data Types: `logical | int8 | uint8 | int16 | uint16 | int32 | uint32 | single | double | binaryFeature object`

features2 — Feature set two

M2-by-*N* matrix | `binaryFeatures` object

Feature set two, specified as a `binaryFeatures` object or an *M2*-by-*N* matrix. The matrix contains *M2* features, and *N* corresponds to the length of each feature vector.

You can obtain the `binaryFeatures` object using the `extractFeatures` function with the fast retina keypoint (FREAK), oriented fast and rotated brief (ORB), or binary robust invariant scalable keypoints (BRISK) descriptor method.

Data Types: `logical | int8 | uint8 | int16 | uint16 | int32 | uint32 | single | double | binaryFeature object`

points2 — Feature points of feature set two

M2-by-2 matrix | *M2*-element feature point array

Feature points of feature set two, specified as either an *M2*-by-2 matrix in the format `[x y]` or an *M2*-element feature point array. For a list of point feature types, see “Point Feature Types”.

Data Types: `single | double | point feature type`

centerPoints — Expected matched locations

M1-by-2 matrix

Expected matched locations in the second image that correspond to the feature points from `features1`, specified as an *M1*-by-2 matrix of coordinates in the format `[x y]`.

Data Types: `single | double`

radius — Search radius associated with center points

scalar | *M1*-element vector

Search radius associated with the center points, specified as a scalar or an *M1*-element vector. When you specify the `radius` as a scalar value, the function uses the same search radius for all center points.

Data Types: `single | double`

Name-Value Pair Arguments

Specify optional comma-separated pairs of `Name, Value` arguments. `Name` is the argument name and `Value` is the corresponding value. `Name` must appear inside quotes. You can specify several name and value pair arguments in any order as `Name1, Value1, . . . , NameN, ValueN`.

Example: `'Metric', 'SSD'` specifies the sum of squared differences metric for feature matching.

MatchThreshold — Matching threshold

`10.0` or `1.0` (default) | scalar value in the range (0, 100]

Matching threshold, specified as a scalar value in the range (0,100]. The default values are `10.0` for binary feature vectors or `1.0` for nonbinary feature vectors. You can use the matching threshold to select the strongest matches. The threshold represents a percent of the distance from a perfect match.

Two feature vectors match when the distance between them is less than the threshold set by 'MatchThreshold'. The function rejects a match when the distance between the features is greater than the value of 'MatchThreshold'. Increase the value to return more matches.

Inputs that are `binaryFeatures` objects typically require a larger value for the match threshold. The `extractFeatures` function returns a `binaryFeatures` object when extracting FREAK, ORB, or BRISK descriptors.

MaxRatio – Ratio threshold

0.6 (default) | scalar value in the range (0, 1]

Ratio threshold, specified as a scalar value in the range (0, 1]. Use the ratio to reject ambiguous matches. Increase this value to return more matches.

Metric – Feature matching metric

'SSD' (default) | 'SAD'

Feature matching metric, specified as either 'SAD' or 'SSD'.

'SAD' Sum of absolute differences

'SSD' Sum of squared differences

This property applies when you specify the input feature sets, `features1` and `features2`, as matrices. When you specify the features as `binaryFeatures` objects, the function uses the Hamming distance to compute the similarity metric.

Unique – Unique matches

false or 0 (default) | true or 1

Unique matches, specified as a logical 0 (false) or 1 (true). Set this value to true to return only unique matches between `features1` and `features2`.

When you set `Unique` to false, the function returns all matches between `features1` and `features2`. Multiple features in `features1` can match to one feature in `features2`.

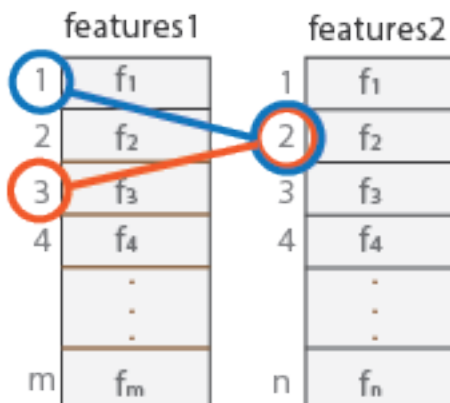

When you set `Unique` to true, the function performs a forward-backward match to select a unique match. After matching `features1` to `features2`, it matches `features2` to `features1` and keeps the best match.

Output Arguments

indexPairs — Indices of corresponding features

P -by-2 matrix

Indices of corresponding features between the two input feature sets, returned as a P -by-2 matrix. P is the number of matched pairs of features. Each index pair corresponds to a matched feature between the `features1` and `features2` inputs. The first element indexes the feature in `features1`. The second element indexes the matching feature in `features2`.

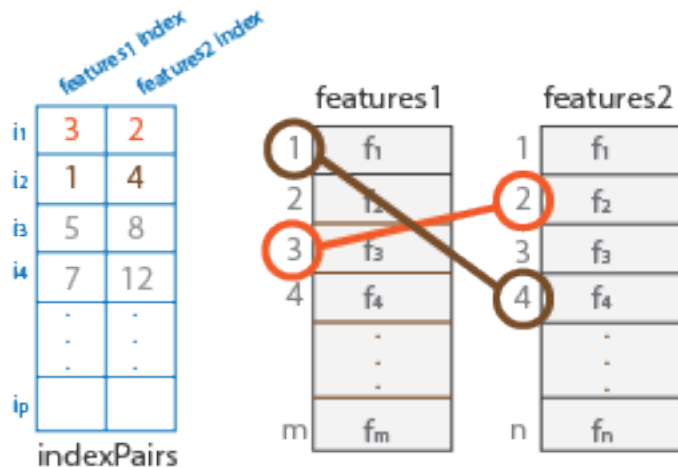

matchMetric — Distance between matching features

P -by-1 vector

Distance between matching features, returned as a P -by-1 vector. The i th element in `matchMetric` corresponds to the i th row in the `indexPairs` output matrix. The values of the distances are based on the metric selected, but a perfect match is always 0. When `Metric` is set to either `SAD` or `SSD`, the feature vectors are normalized to unit vectors before computation. The function returns `matchMetric` as a double data type when `features1` and `features2` are of type double. Otherwise, the returned vector is of type single.

Metric	Range
SAD	[0, 2*sqrt(size(features1,2))].
SSD	[0, 4]
Hamming	[0, features1.NumBits]

Note You cannot select the Hamming metric. The metric is selected automatically when the `features1` and `features2` inputs are `binaryFeatures`.

Data Types: single | double

Tips

- Use this function when the 3-D world points that correspond to feature set one `features1`, are known. `centerPoints` can be obtained by projecting a 3-D world point onto the second image.

You can obtain the 3-D world points by triangulating matched image points from two stereo images.

- You can specify a circular area of points in feature set two to match with feature set one. Specify the origin as `centerPoints` with a radius specified by `radius`. Specify the points to match from feature set two as `points2`

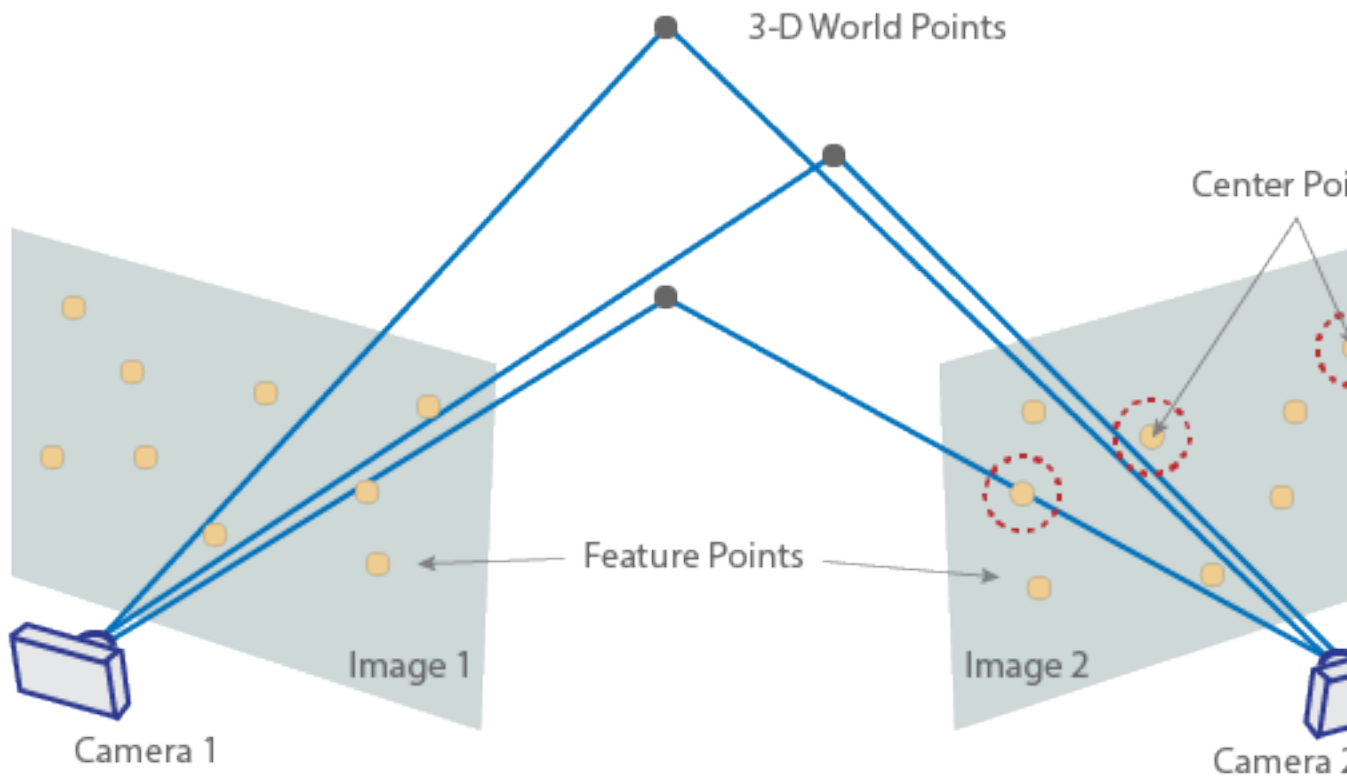

References

- [1] Fraundorfer, Friedrich, and Davide Scaramuzza. "Visual Odometry: Part II: Matching, Robustness, Optimization, and Applications." *IEEE Robotics & Automation Magazine* 19, no. 2 (June 2012): 78-90. <https://doi.org/10.1109/MRA.2012.2182810>.
- [2] Lowe, David G. "Distinctive Image Features from Scale-Invariant Keypoints." *International Journal of Computer Vision* 60, no. 2 (November 2004): 91-110. <https://doi.org/10.1023/B:VISI.0000029664.99615.94>.
- [3] Muja, Marius, and David G. Lowe. "Fast Approximate Nearest Neighbors With Automatic Algorithm Configuration." In *Proceedings of the Fourth International Conference on Computer Vision Theory and Applications*, 331-40. Lisboa, Portugal: SciTePress - Science and Technology Publications, 2009. <https://doi.org/10.5220/0001787803310340>.
- [4] Muja, Marius, and David G. Lowe. "Fast Matching of Binary Features." In *2012 Ninth Conference on Computer and Robot Vision*, 404-10. New York: Institute of Electrical and Electronics Engineers, 2012. <https://doi.org/10.1109/CRV.2012.60>.

Extended Capabilities

C/C++ Code Generation

Generate C and C++ code using MATLAB® Coder™.

Usage notes and limitations:

- 'Method' and 'Metric' must be compile-time constants.

See Also

Functions

[showMatchedFeatures](#) | [extractFeatures](#) | [detectHarrisFeatures](#) | [detectSURFFeatures](#) | [detectORBFeatures](#) | [detectFASTFeatures](#) | [detectBRISKFeatures](#) | [detectMinEigenFeatures](#) | [estimateFundamentalMatrix](#) | [estimateGeometricTransform](#) | [detectMSERFeatures](#) | [estimateWorldCameraPose](#) | [worldToImage](#)

Objects

[binaryFeatures](#)

Topics

[“Structure from Motion Overview”](#)

[“Monocular Visual Simultaneous Localization and Mapping”](#)

[“Implement Visual SLAM in MATLAB”](#)

Introduced in R2021a

mplay

View video from MATLAB workspace, multimedia file, or Simulink model.

Syntax

Description

Note The `mplay` function will be removed in a future release. Use the **Video Viewer** app instead, which offers identical functionality.

Introduced in R2006a

OCR

Recognize text using optical character recognition

Syntax

```
txt = ocr(I)
txt = ocr(I, roi)

[ ___ ] = ocr( ___ ,Name,Value)
```

Description

`txt = ocr(I)` returns an `ocrText` object containing optical character recognition information from the input image, `I`. The object contains recognized text, text location, and a metric indicating the confidence of the recognition result.

`txt = ocr(I, roi)` recognizes text in `I` within one or more rectangular regions. The `roi` input contains an M -by-4 matrix, with M regions of interest.

`[___] = ocr(___ ,Name,Value)` uses additional options specified by one or more `Name,Value` pair arguments, using any of the preceding syntaxes.

Examples

Recognize Text Within an Image

```
businessCard = imread('businessCard.png');
ocrResults = ocr(businessCard)

ocrResults =
    ocrText with properties:
        Text: '' MathWorks@...'
        CharacterBoundingBoxes: [103x4 double]
        CharacterConfidences: [103x1 single]
        Words: {16x1 cell}
        WordBoundingBoxes: [16x4 double]
        WordConfidences: [16x1 single]

recognizedText = ocrResults.Text;
figure;
imshow(businessCard);
text(600, 150, recognizedText, 'BackgroundColor', [1 1 1]);
```



Recognize Text in Regions of Interest (ROI)

Read image.

```
I = imread('handicapSign.jpg');
```

Define one or more rectangular regions of interest within I.

```
roi = [360 118 384 560];
```

You may also use IMRECT to select a region using a mouse: `figure; imshow(I); roi = round(getPosition(imrect))`

```
ocrResults = ocr(I, roi);
```

Insert recognized text into original image

```
Iocr = insertText(I,roi(1:2),ocrResults.Text,'AnchorPoint',...
    'RightTop','FontSize',16);
figure; imshow(Iocr);
```



Display Bounding Boxes of Words and Recognition Confidences

```

businessCard = imread('businessCard.png');
ocrResults = ocr(businessCard)

ocrResults =
    ocrText with properties:
        Text: '' MathWorks@...'
        CharacterBoundingBoxes: [103x4 double]
        CharacterConfidences: [103x1 single]
        Words: {16x1 cell}
        WordBoundingBoxes: [16x4 double]
        WordConfidences: [16x1 single]

Iocr = insertObjectAnnotation(businessCard, 'rectangle', ...
    ocrResults.WordBoundingBoxes, ...
    ocrResults.WordConfidences);
figure; imshow(Iocr);

```

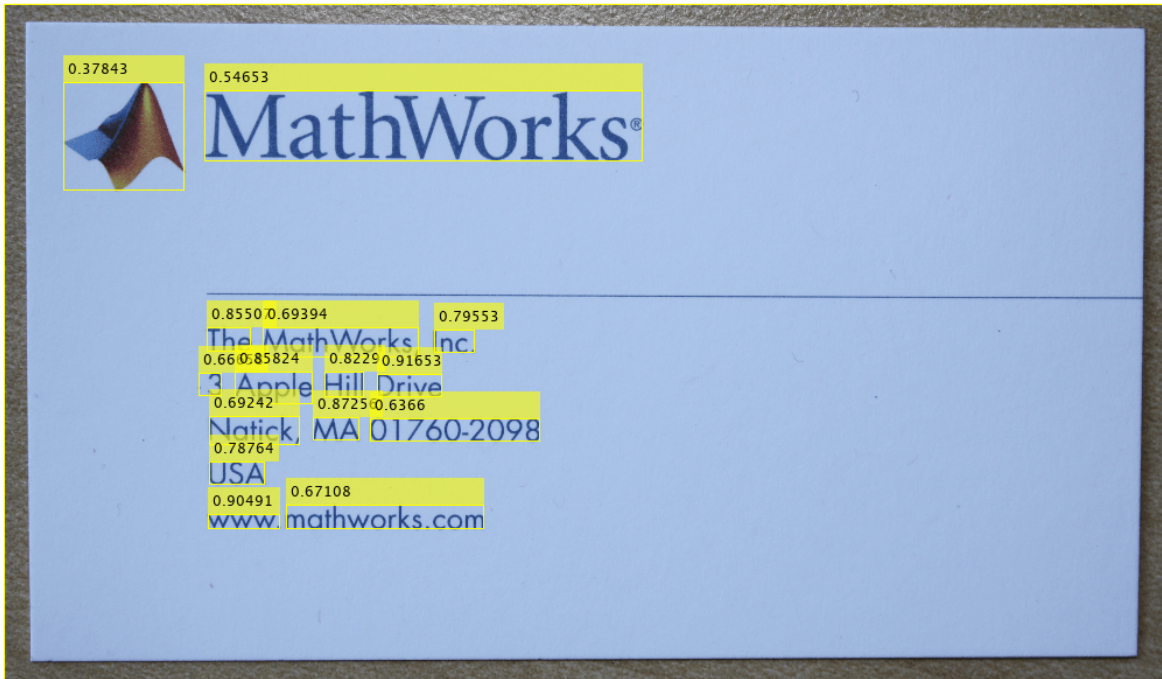

Find and Highlight Text in an Image

```
businessCard = imread('businessCard.png');  
ocrResults = ocr(businessCard);  
bboxes = locateText(ocrResults, 'MathWorks', 'IgnoreCase', true);  
Iocr = insertShape(businessCard, 'FilledRectangle', bboxes);  
figure; imshow(Iocr);
```

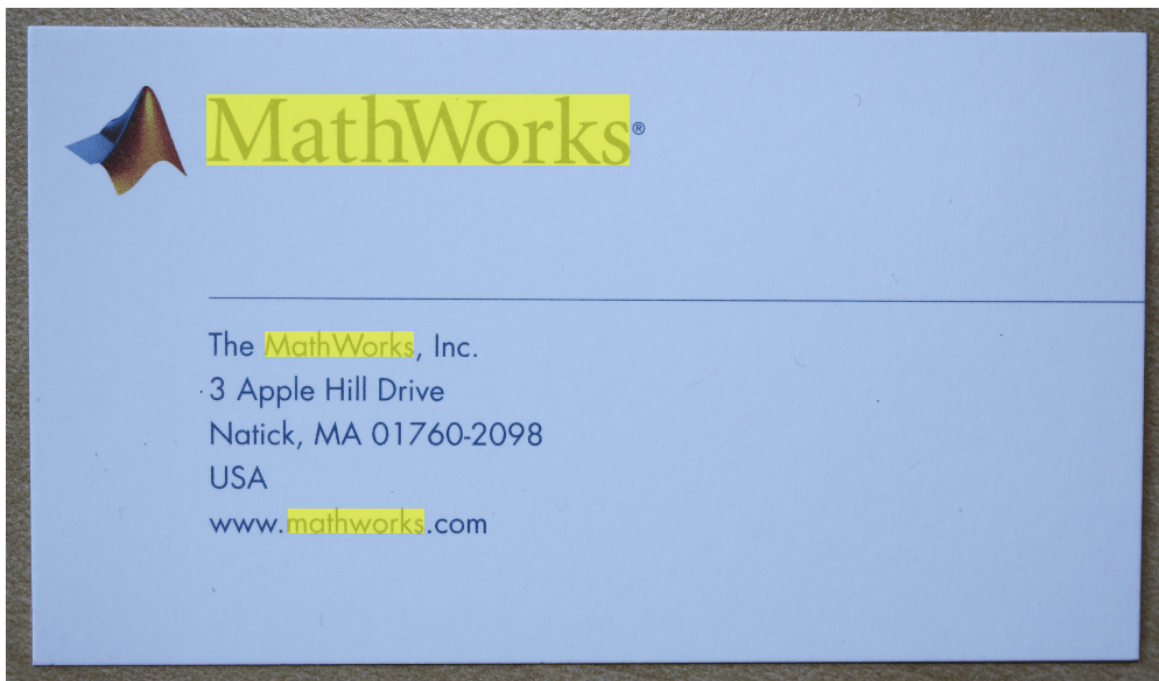

Input Arguments

I — Input image

M-by-*N*-by-3 truecolor image | *M*-by-*N* 2-D grayscale image | *M*-by-*N* binary image

Input image, specified in *M*-by-*N*-by-3 truecolor, *M*-by-*N* 2-D grayscale, or binary format. The input image must be a real, nonsparse value. The function converts truecolor or grayscale input images to a binary image, before the recognition process. It uses the Otsu's thresholding technique for the conversion. For best ocr results, the height of a lowercase 'x', or comparable character in the input image, must be greater than 20 pixels. From either the horizontal or vertical axes, remove any text rotations greater than +/- 10 degrees, to improve recognition results.

Data Types: `single` | `double` | `int16` | `uint8` | `uint16` | `logical`

roi — Region of interest

M-by-4 element matrix

One or more rectangular regions of interest, specified as an *M*-by-4 element matrix. Each row, *M*, specifies a region of interest within the input image, as a four-element vector, [*x* *y* *width* *height*]. The vector specifies the upper-left corner location, [*x* *y*], and the size of a rectangular region of interest, [*width* *height*], in pixels. Each rectangle must be fully contained within the input image, *I*. Before the recognition process, the function uses the Otsu's thresholding to convert truecolor and grayscale input regions of interest to binary regions. The function returns text recognized in the rectangular regions as an array of objects.

Name-Value Pair Arguments

Specify optional comma-separated pairs of `Name`, `Value` arguments. `Name` is the argument name and `Value` is the corresponding value. `Name` must appear inside quotes. You can specify several name and value pair arguments in any order as `Name1, Value1, . . . , NameN, ValueN`.

Example: `ocr(I, 'TextLayout', 'Block')`

TextLayout – Input text layout

'Auto' (default) | 'Block' | 'Line' | 'Word' | 'Character'

Input text layout, specified as the comma-separated pair consisting of 'TextLayout' and one of the following:

TextLayout	Text Treatment
'Auto'	Determines the layout and reading order of text blocks within the input image.
'Block'	Treats the text in the image as a single block of text.
'Line'	Treats the text in the image as a single line of text.
'Word'	Treats the text in the image as a single word of text.
'Character'	Treats the text in the image as a single character.

Use the automatic layout analysis to recognize text from a scanned document that contains a specific format, such as a double column. This setting preserves the reading order in the returned text. You may get poor results if your input image contains a few regions of text or the text is located in a cluttered scene. If you get poor OCR results, try a different layout that matches the text in your image. If the text is located in a cluttered scene, try specifying an ROI around the text in your image in addition to trying a different layout.

Language – Language

'English' (default) | 'Japanese' | character vector | string scalar | cell array of character vectors | string array

Language to recognize, specified as the comma-separated pair consisting of 'Language' and the character vector 'English', 'Japanese', or a cell array of character vectors. You can also install the “Install OCR Language Data Files” package for additional languages or add a custom language. Specifying multiple languages enables simultaneous recognition of all the selected languages. However, selecting more than one language may reduce the accuracy and increase the time it takes to perform ocr.

To specify any of the additional languages which are contained in the “Install OCR Language Data Files” package, use the language character vector the same way as the built-in languages. You do not need to specify the path.

```
txt = ocr(img, 'Language', 'Finnish');
```

List of Support Package OCR Languages

- 'Afrikaans'

- 'Albanian'
- 'AncientGreek'
- 'Arabic'
- 'Azerbaijani'
- 'Basque'
- 'Belarusian'
- 'Bengali'
- 'Bulgarian'
- 'Catalan'
- 'Cherokee'
- 'ChineseSimplified'
- 'ChineseTraditional'
- 'Croatian'
- 'Czech'
- 'Danish'
- 'Dutch'
- 'English'
- 'Esperanto'
- 'EsperantoAlternative'
- 'Estonian'
- 'Finnish'
- 'Frankish'
- 'French'
- 'Galician'
- 'German'
- 'Greek'
- 'Hebrew'
- 'Hindi'
- 'Hungarian'
- 'Icelandic'
- 'Indonesian'
- 'Italian'
- 'ItalianOld'
- 'Japanese'
- 'Kannada'
- 'Korean'
- 'Latvian'
- 'Lithuanian'
- 'Macedonian'

- 'Malay'
- 'Malayalam'
- 'Maltese'
- 'MathEquation'
- 'MiddleEnglish'
- 'MiddleFrench'
- 'Norwegian'
- 'Polish'
- 'Portuguese'
- 'Romanian'
- 'Russian'
- 'SerbianLatin'
- 'Slovakian'
- 'Slovenian'
- 'Spanish'
- 'SpanishOld'
- 'Swahili'
- 'Swedish'
- 'Tagalog'
- 'Tamil'
- 'Telugu'
- 'Thai'
- 'Turkish'
- 'Ukrainian'

To use your own custom languages, specify the path to the trained data file as the language character vector. You must name the file in the format, *<language>.traineddata*. The file must be located in a folder named 'tessdata'. For example:

```
txt = ocr(img, 'Language', 'path/to/tessdata/eng.traineddata');
```

You can load multiple custom languages as a cell array of character vectors:

```
txt = ocr(img, 'Language', ...  
          {'path/to/tessdata/eng.traineddata', ...  
           'path/to/tessdata/jpn.traineddata'});
```

The containing folder must always be the same for all the files specified in the cell array. In the preceding example, all of the `traineddata` files in the cell array are contained in the folder 'path/to/tessdata'. Because the following code points to two different containing folders, it does not work.

```
txt = ocr(img, 'Language', ...  
          {'path/one/tessdata/eng.traineddata', ...  
           'path/two/tessdata/jpn.traineddata'});
```

Some language files have a dependency on another language. For example, Hindi training depends on English. If you want to use Hindi, the English `traineddata` file must also exist in the same folder as

the Hindi `traineddata` file. The ocr only supports `traineddata` files created using `tesseract-ocr 3.02` or using the **OCR Trainer**.

For deployment targets generated by MATLAB Coder: Generated ocr executable and language data file folder must be colocated. The `tessdata` folder must be named `tessdata`:

- For English: `C:/path/tessdata/eng.traineddata`
- For Japanese: `C:/path/tessdata/jpn.traineddata`
- For custom data files: `C:/path/tessdata/customlang.traineddata`
- `C:/path/ocr_app.exe`

You can copy the English and Japanese trained data files from:

```
fullfile(matlabroot, 'toolbox','vision','visionutilities','tessdata');
```

CharacterSet — Character subset

' ' all characters (default) | character vector | string scalar

Character subset, specified as the comma-separated pair consisting of 'CharacterSet' and a character vector. By default, CharacterSet is set to the empty character vector, ' '. The empty vector sets the function to search for all characters in the language specified by the `Language` property. You can set this property to a smaller set of known characters to constrain the classification process.

The `ocr` function selects the best match from the CharacterSet. Using deducible knowledge about the characters in the input image helps to improve text recognition accuracy. For example, if you set CharacterSet to all numeric digits, '0123456789', the function attempts to match each character to only digits. In this case, a non-digit character can incorrectly get recognized as a digit.

Output Arguments

txt — Recognized text and metrics

ocrText object

Recognized text and metrics, returned as an `ocrText` object. The object contains the recognized text, the location of the recognized text within the input image, and the metrics indicating the confidence of the results. The confidence values range is [0 1] and represents a percent probability. When you specify an M -by-4 `roi`, the function returns `ocrText` as an M -by-1 array of `ocrText` objects.

If your `ocr` results are not what you expect, try one or more of the following options:

- Increase the image 2-to-4 times the original size.
- If the characters in the image are too close together or their edges are touching, use `morphology` to thin out the characters. Using `morphology` to thin out the characters separates the characters.
- Use `binarization` to check for non-uniform lighting issues. Use the `graythresh` and `imbinarize` functions to binarize the image. If the characters are not visible in the results of the binarization, it indicates a potential non-uniform lighting issue. Try `top hat`, using the `imtophat` function, or other techniques that deal with removing non-uniform illumination.
- Use the region of interest `roi` option to isolate the text. Specify the `roi` manually or use `text detection`.

- If your image looks like a natural scene containing words, like a street scene, rather than a scanned document, try using an ROI input. Also, you can set the `TextLayout` property to 'Block' or 'Word'.

References

- [1] R. Smith. *An Overview of the Tesseract OCR Engine*, Proceedings of the Ninth International Conference on Document Analysis and Recognition (ICDAR 2007) Vol 2 (2007), pp. 629-633.
- [2] Smith, R., D. Antonova, and D. Lee. *Adapting the Tesseract Open Source OCR Engine for Multilingual OCR*. Proceedings of the International Workshop on Multilingual OCR, (2009).
- [3] R. Smith. *Hybrid Page Layout Analysis via Tab-Stop Detection*. Proceedings of the 10th international conference on document analysis and recognition. 2009.

Extended Capabilities

C/C++ Code Generation

Generate C and C++ code using MATLAB® Coder™.

Usage notes and limitations:

- 'TextLayout', 'Language', and 'CharacterSet' must be compile-time constants.
- Generated code for this function uses a precompiled platform-specific shared library.

See Also

OCR Trainer | `ocrText` | `insertShape` | `graythresh` | `imbinarize` | `imtophat`

Topics

“Automatically Detect and Recognize Text in Natural Images”

“Recognize Text Using Optical Character Recognition (OCR)”

“Train Optical Character Recognition for Custom Fonts”

“Install OCR Language Data Files”

“Install Computer Vision Toolbox Add-on Support Files”

Introduced in R2014a

pcdenoise

Remove noise from 3-D point cloud

Syntax

```
ptCloudOut = pcdenoise(ptCloudIn)
[ptCloudOut,inlierIndices,outlierIndices] = pcdenoise(ptCloudIn)
[ptCloudOut, ___] = pcdenoise(___ Name,Value)
```

Description

`ptCloudOut = pcdenoise(ptCloudIn)` returns a filtered point cloud that removes outliers.

`[ptCloudOut,inlierIndices,outlierIndices] = pcdenoise(ptCloudIn)` additionally returns the linear indices to the points that are identified as inliers and outliers.

`[ptCloudOut, ___] = pcdenoise(___ Name,Value)` uses additional options specified by one or more `Name,Value` pair arguments, using any of the preceding syntaxes.

Examples

Remove Outliers from Noisy Point Cloud

Create a plane point cloud.

```
gv = 0:0.01:1;
[X,Y] = meshgrid(gv,gv);
ptCloud = pointCloud([X(:),Y(:),0.5*ones(numel(X),1)]);

figure
pcshow(ptCloud);
title('Original Data');
```

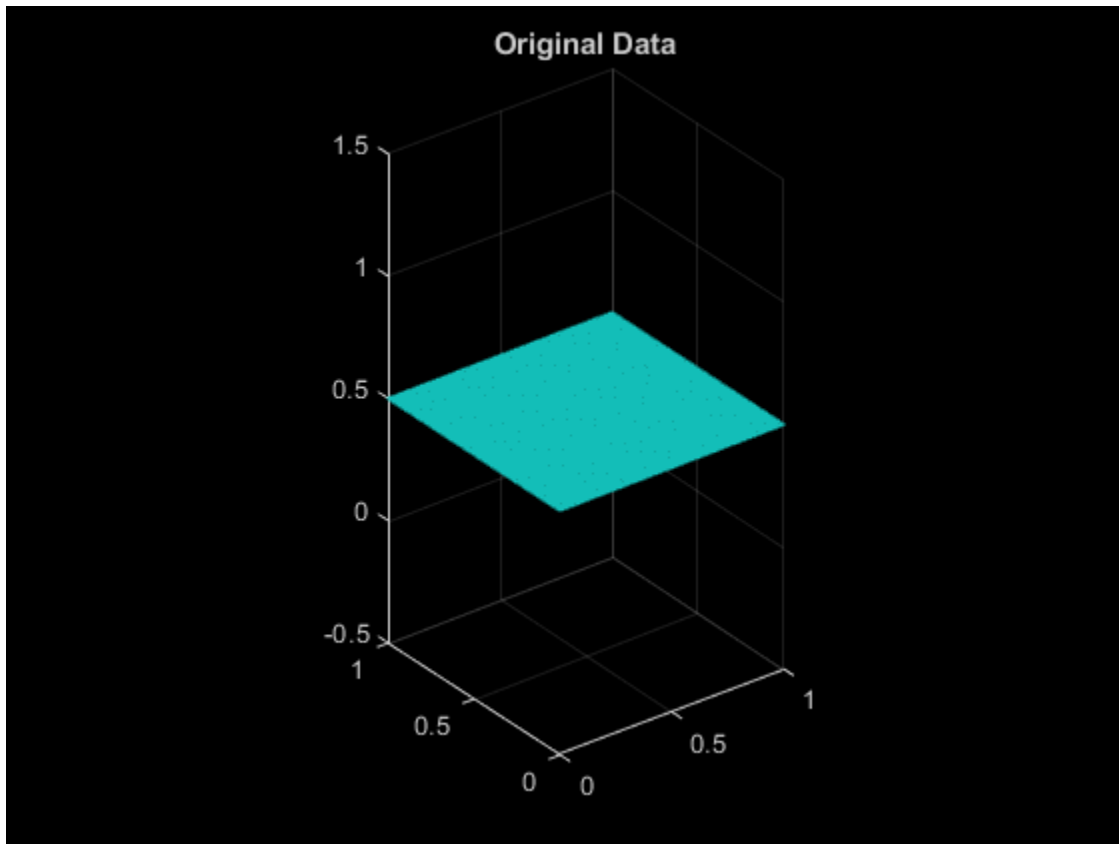

Add uniformly distributed random noise.

```
noise = rand(500, 3);  
ptCloudA = pointCloud([ptCloud.Location; noise]);
```

```
figure  
pcshow(ptCloudA);  
title('Noisy Data');
```

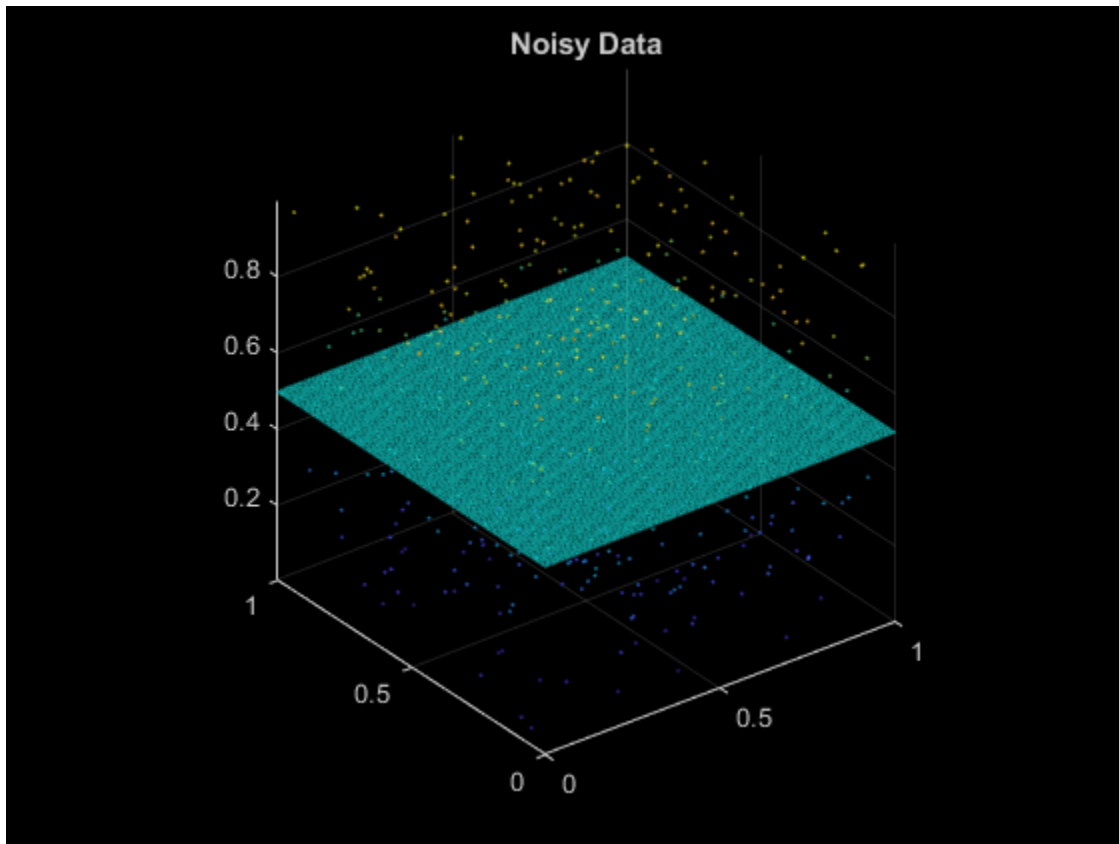

Remove outliers.

```
ptCloudB = pcdenoise(ptCloudA);
```

```
figure;  
pcshow(ptCloudB);  
title('Denoised Data');
```

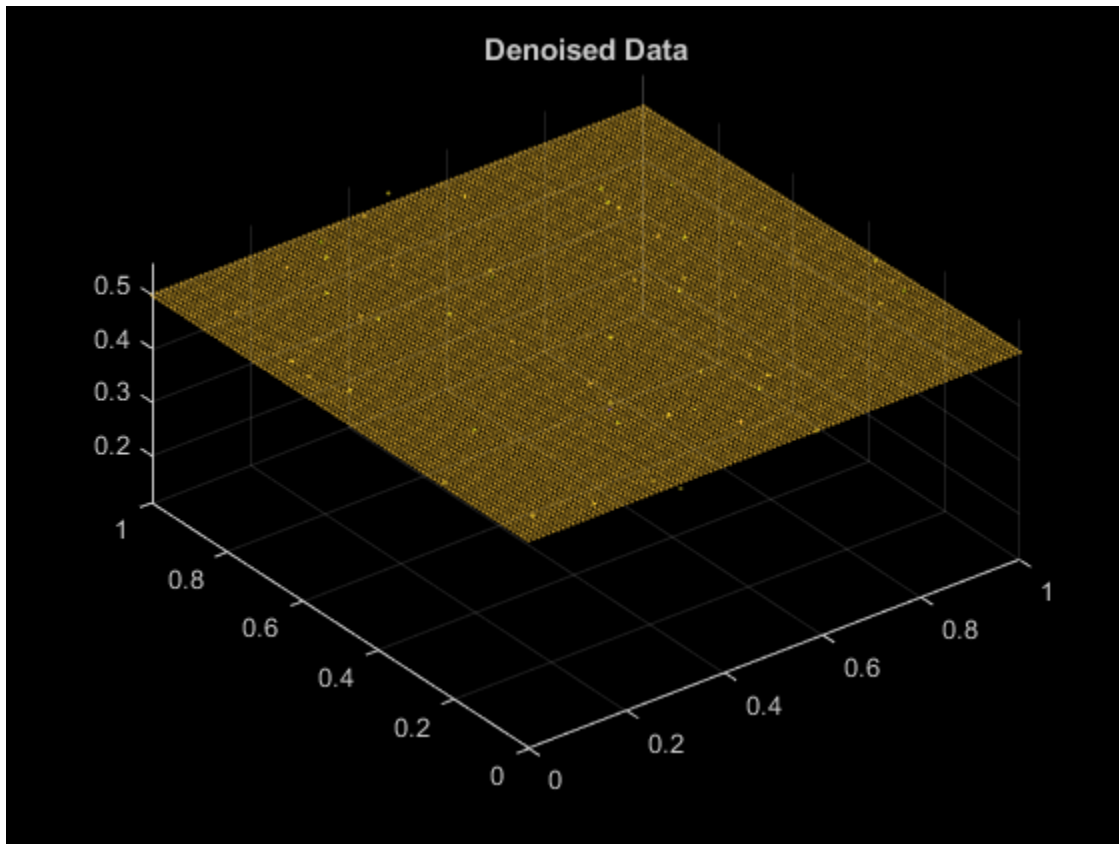

Input Arguments

ptCloudIn — Point cloud

pointCloud object

Point cloud, specified as a pointCloud object.

Name-Value Pair Arguments

Specify optional comma-separated pairs of `Name, Value` arguments. `Name` is the argument name and `Value` is the corresponding value. `Name` must appear inside quotes. You can specify several name and value pair arguments in any order as `Name1, Value1, ..., NameN, ValueN`.

Example: `'Threshold', 1.0` sets the threshold to 1.0.

NumNeighbors — Number of nearest neighbor points

4 (default) | positive integer

Number of nearest neighbor points, specified as the comma-separated pair consisting of `'NumNeighbors'` and a positive integer in pixels. The value is used to estimate the mean of the average distance to neighbors of all points. Decreasing this value makes the filter more sensitive to noise. Increasing this value increases the number of computations.

Data Types: single | double

Threshold — Outlier threshold

1.0 (default) | scalar

Outlier threshold, specified as the comma-separated pair consisting of 'Threshold' and a scalar. By default, the threshold is one standard deviation from the mean of the average distance to neighbors of all points. A point is considered to be an outlier if the average distance to its k -nearest neighbors is above the specified threshold.

Data Types: single | double

Output Arguments**ptCloudOut — Filtered point cloud**

pointCloud object

Filtered point cloud, returned as a pointCloud object.

inlierIndices — Linear index of inlier points1-by- N vector

Linear index of inlier points, returned as a 1-by- N vector.

Data Types: uint32

outlierIndices — Linear index of outlier points1-by- N vector

Linear index of outlier points, returned as a 1-by- N vector of linear indices.

Data Types: uint32

References

- [1] Rusu, R. B., Z. C. Marton, N. Blodow, M. Dolha, and M. Beetz. "Towards 3D Point Cloud Based Object Maps for Household Environments". *Robotics and Autonomous Systems Journal*. 2008.

Extended Capabilities**C/C++ Code Generation**

Generate C and C++ code using MATLAB® Coder™.

GPU Code Generation

Generate CUDA® code for NVIDIA® GPUs using GPU Coder™.

See Also

pointCloud | pcshow | pcplayer | pcwrite | pcread | pcfitplane | planeModel | pcmerge | pctransform | pcdsample | pcregistericp | affine3d

Topics

"3-D Point Cloud Registration and Stitching"

Introduced in R2015a

pcmerge

Merge two 3-D point clouds

Syntax

```
ptCloudOut = pcmerge(ptCloudA,ptCloudB,gridStep)
```

Description

`ptCloudOut = pcmerge(ptCloudA,ptCloudB,gridStep)` returns a merged point cloud using a box grid filter. `gridStep` specifies the size of the 3-D box for the filter.

Examples

Merge Two Identical Point Clouds Using Box Grid Filter

Create a point cloud with X, Y, Z points in [0, 100].

```
ptCloudA = pointCloud(100*rand(1000,3));
```

Create a partially overlapping point cloud.

```
ptCloudB = pointCloud([70 20 30] + 100*rand(1000,3));
```

Merge the two point clouds using a box filter.

```
ptCloudOut = pcmerge(ptCloudA, ptCloudB, 1);  
pcshow(ptCloudOut);
```

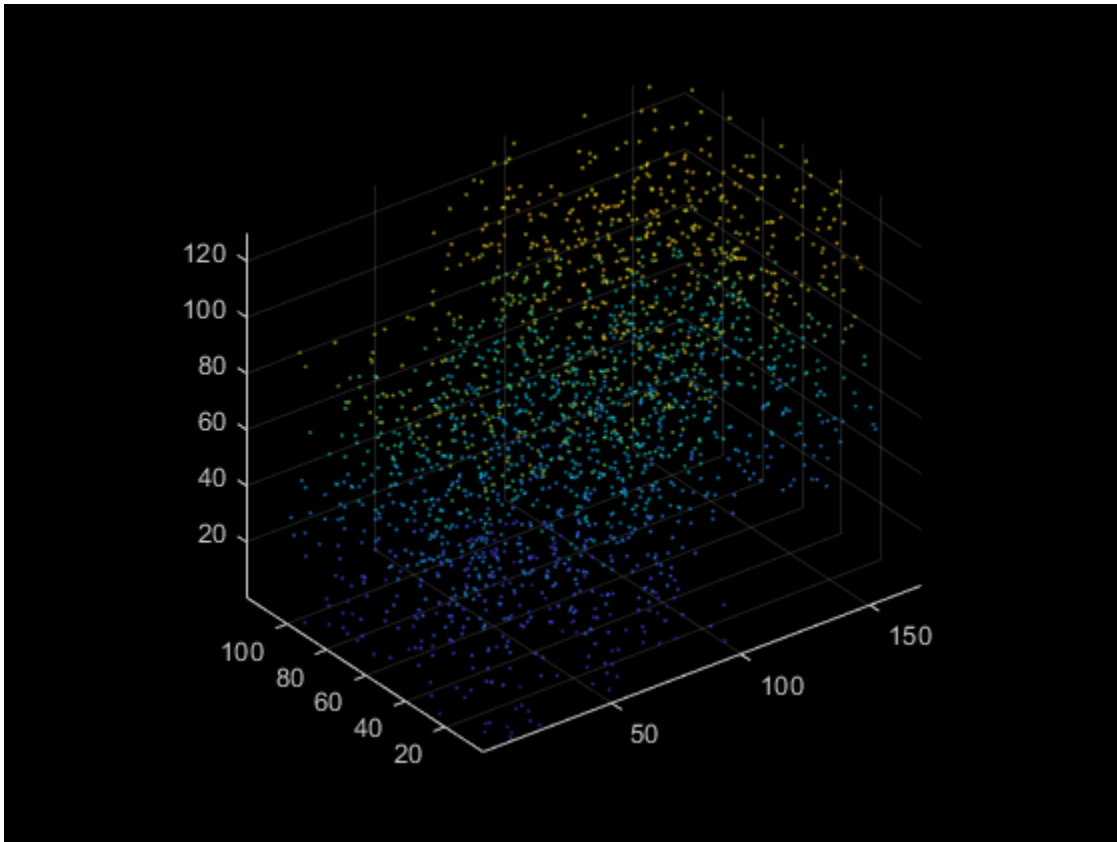

Input Arguments

ptCloudA — Point cloud A

`pointCloud` object

Point cloud A, specified as a `pointCloud` object.

ptCloudB — Point cloud B

`pointCloud` object

Point cloud B, specified as a `pointCloud` object.

gridStep — Size of 3-D box for grid filter

numeric value

Size of 3-D box for grid filter, specified as a numeric value. Increase the size of `gridStep` when there are not enough resources to construct a large fine-grained grid. The function divides the space into 3-D boxes (also known as voxels), of size `gridStep`. It then takes an average of all points contained in each voxel. The result of the average provides a new point to represent all the points in the voxel for the merged output.

Data Types: `single` | `double`

Output Arguments

ptCloudOut — Merged point cloud

pointCloud object

Merged point cloud, returned as a `pointCloud` object. The function computes the axis-aligned bounding box for the overlapped region between two point clouds. The bounding box is divided into grid boxes of the size specified by `gridStep`. Points within each grid box are merged by averaging their locations, colors, and normals. Points outside the overlapped region are untouched.

Tips

- If the two point clouds do not have the same set of properties filled, such as `Color` or `Normal`, these properties will be cleared in the returned point cloud. For example, if `ptCloudA` has color but `ptCloudB` does not, then `ptCloudOut` will not contain color.
- The function filters out points with `NaN` or `Inf` values.

Extended Capabilities

C/C++ Code Generation

Generate C and C++ code using MATLAB® Coder™.

GPU Code Generation

Generate CUDA® code for NVIDIA® GPUs using GPU Coder™.

See Also

Objects

`pointCloud` | `planeModel` | `affine3d` | `rigid3d`

Functions

`pcplayer` | `pcshow` | `pcwrite` | `pcread` | `pctransform` | `pcdownsample` | `pcfitplane` | `pcdenoise` | `pcregistericp` | `pccat` | `pcalign`

Topics

“3-D Point Cloud Registration and Stitching”

Introduced in R2015a

pcdownsample

Downsample a 3-D point cloud

Syntax

```
ptCloudOut = pcdownsample(ptCloudIn,'random',percentage)
ptCloudOut = pcdownsample(ptCloudIn,'gridAverage',gridStep)
ptCloudOut = pcdownsample(ptCloudIn,'nonuniformGridSample',maxNumPoints)
```

Description

`ptCloudOut = pcdownsample(ptCloudIn,'random',percentage)` returns a downsampled point cloud with random sampling and without replacement. The `percentage` input specifies the portion of the input to return to the output.

`ptCloudOut = pcdownsample(ptCloudIn,'gridAverage',gridStep)` returns a downsampled point cloud using a box grid filter. The `gridStep` input specifies the size of a 3-D box.

`ptCloudOut = pcdownsample(ptCloudIn,'nonuniformGridSample',maxNumPoints)` returns a downsampled point cloud using nonuniform box grid filter. You must set the maximum number of points in the grid box, `maxNumPoints`, to at least 6.

Examples

Downsample Point Cloud Using Box Grid Filter

Read a point cloud.

```
ptCloud = pcread('teapot.ply');
```

Set the 3-D resolution to be (0.1 x 0.1 x 0.1).

```
gridStep = 0.1;
ptCloudA = pcdownsample(ptCloud,'gridAverage',gridStep);
```

Visualize the downsampled data.

```
figure;
pcshow(ptCloudA);
```

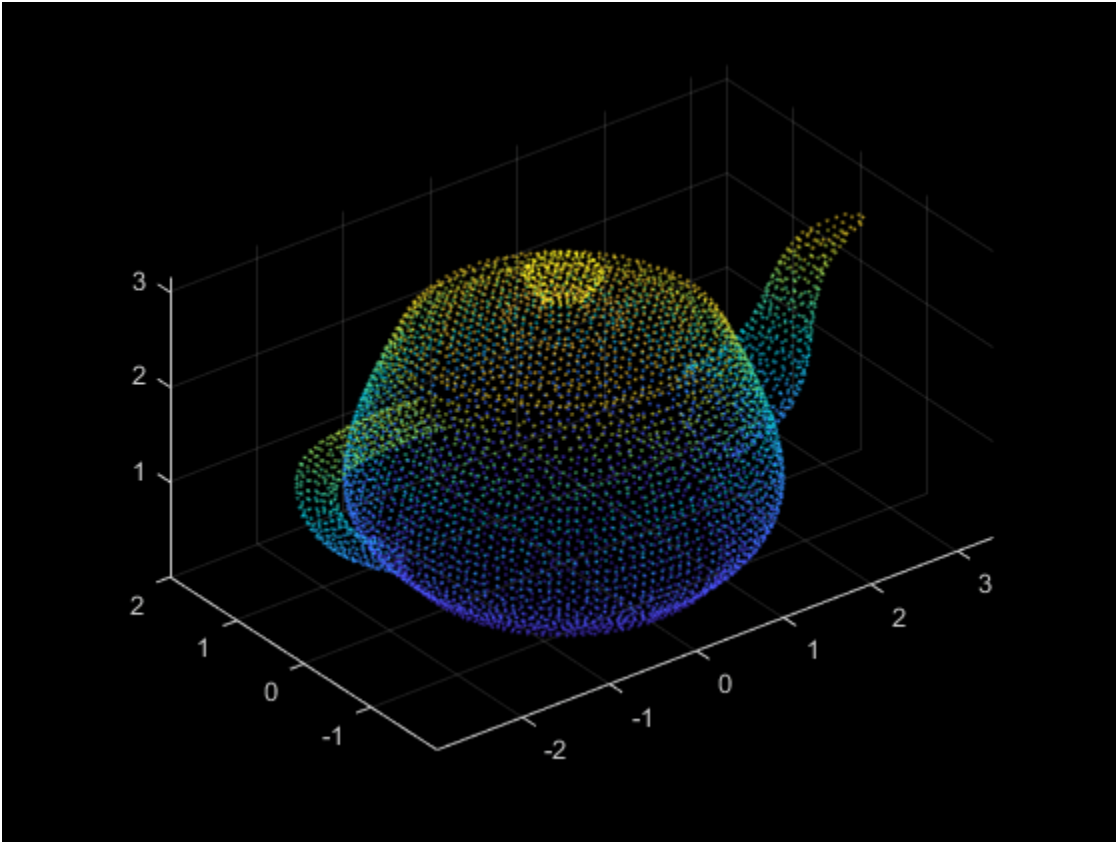

Compare the point cloud to data that is downsampled using a fixed step size.

```
stepSize = floor(ptCloud.Count/ptCloudA.Count);  
indices = 1:stepSize:ptCloud.Count;  
ptCloudB = select(ptCloud, indices);
```

```
figure;  
pcshow(ptCloudB);
```

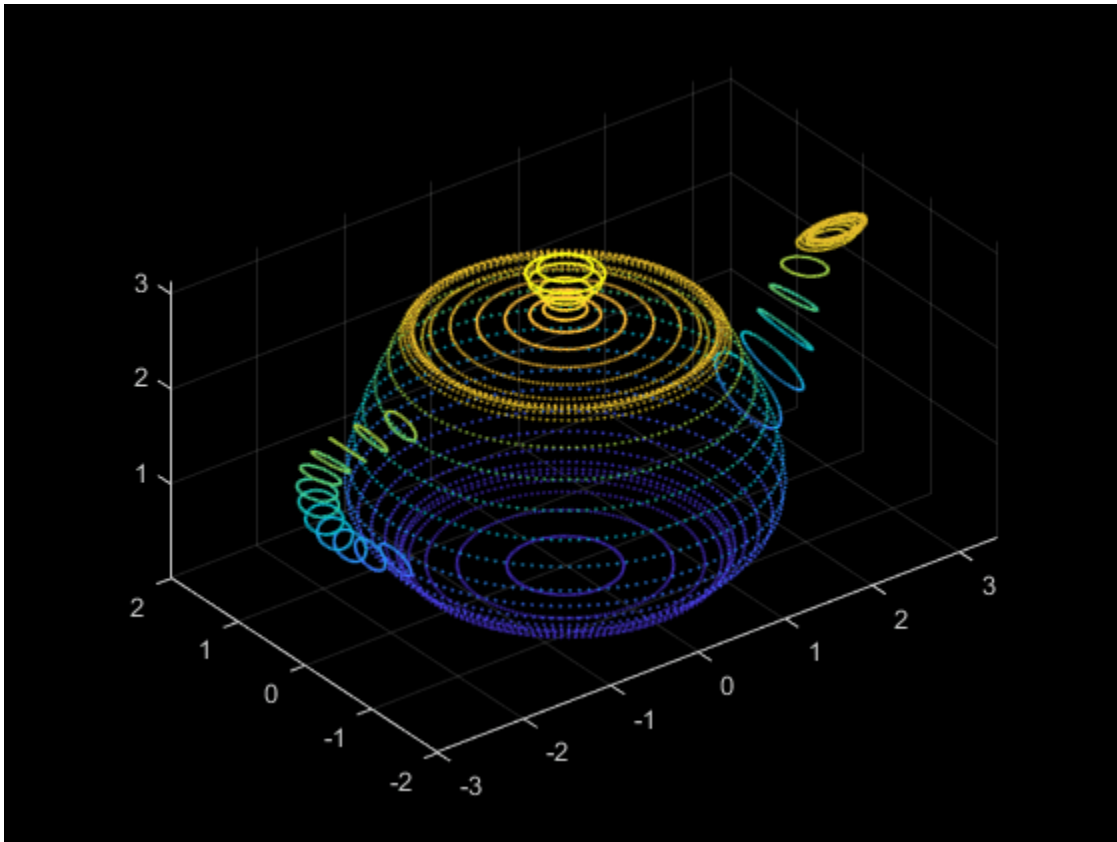

Remove Redundant Points from Point Cloud

Create a point cloud with all points sharing the same coordinates.

```
ptCloud = pointCloud(ones(100,3));
```

Set the 3-D resolution to a small value.

```
gridStep = 0.01;
```

The output now contains only one unique point.

```
ptCloudOut = pcdownsample(ptCloud, 'gridAverage', gridStep)
```

```
ptCloudOut =  
  pointCloud with properties:
```

```
  Location: [1 1 1]  
  Count: 1  
  XLimits: [1 1]  
  YLimits: [1 1]  
  ZLimits: [1 1]  
  Color: [0x3 uint8]  
  Normal: [0x3 double]  
  Intensity: [0x1 double]
```

Input Arguments

ptCloudIn — Point cloud

pointCloud object

Point cloud, specified as a pointCloud object.

'random' — Random downsample method

'random'

Random downsample method, specified as 'random'. The 'random' method is more efficient than the 'gridAverage' downsample method, especially when it is applied before point cloud registration.

Downsample the point cloud using 'random', 'gridAverage', or 'nonuniformGridSample' inputs, according to the Metric you use in the pregistericp function for registration.

Metric	Moving PointCloud Downsample Method	Fixed Point Cloud Downsample Method
'pointToPoint'	'random'	'random'
	'gridAverage'	'gridAverage'
'pointToPlane'	'gridAverage'	'gridAverage'
	'random'	'nonuniformGridSample'

percentage — Percentage of input

positive scalar

Percentage of input, specified as a positive scalar in the range [0, 1]. The percentage input specifies the portion of the input for the function to return.

'gridAverage' — Grid average downsample method

'gridAverage'

Grid average downsample method, specified as 'gridAverage'. Points within the same box are merged to a single point in the output. Their color and normal properties are averaged accordingly. This method preserves the shape of the point cloud better than the 'random' downsample method.

The function computes the axis-aligned bounding box for the entire point cloud. The bounding box is divided into grid boxes of size specified by gridStep. Points within each grid box are merged by averaging their locations, colors, and normals.

Downsample the point cloud using 'random', 'gridAverage', or 'nonuniformGridSample' inputs, according to the Metric you use in the pregistericp function for registration.

Metric	Moving PointCloud Downsample Method	Fixed Point Cloud Downsample Method
'pointToPoint'	'random'	'random'
	'gridAverage'	'gridAverage'
'pointToPlane'	'gridAverage'	'gridAverage'

Metric	Moving PointCloud Downsample Method	Fixed Point Cloud Downsample Method
	'random'	'nonuniformGridSample'

gridStep — Size of 3-D box for grid filter

numeric value

Size of 3-D box for grid filter, specified as a numeric value. Increase the size of `gridStep` when there are not enough resources to construct a large fine-grained grid.

Data Types: `single` | `double`

'nonuniformGridSample' — Nonuniform grid sample method

'nonuniformGridSample'

Nonuniform grid sample method, specified as 'nonuniformGridSample'. The best use of this method is to apply it as a preprocessing step to the `pcregistericp` function for point cloud registration, when you use the 'pointToPlane' metric. When you use the 'nonuniformGridSample' algorithm, the normals are computed on the original data prior to downsampling. The downsampled output preserves more accurate normals.

Downsample the point cloud using 'random', 'gridAverage', or 'nonuniformGridSample' inputs, according to the Metric you use in the `pcregistericp` function for registration.

Metric	Moving PointCloud Downsample Method	Fixed Point Cloud Downsample Method
'pointToPoint'	'random'	'random'
	'gridAverage'	'gridAverage'
'pointToPlane'	'gridAverage'	'gridAverage'
	'random'	'nonuniformGridSample'

maxNumPoints — Maximum number of points in grid box

integer

Maximum number of points in grid box, specified as an integer greater than 6. The method randomly selects a single point from each box. If the normal was not provided in the input point cloud, this method automatically fills in the normal property in the `ptCloudOut` output.

Output Arguments

ptCloudOut — Downsampled point cloud

`pointCloud` object

Downsampled point cloud, returned as a `pointCloud` object.

References

- [1] Pomerleau, F., F. Colas, R. Siegwart, and S. Magnenat. "Comparing ICP variants on real-world data sets." *Autonomous Robots*. Vol. 34, Issue 3, April 2013, pp. 133–148.

Extended Capabilities

C/C++ Code Generation

Generate C and C++ code using MATLAB® Coder™.

GPU Code Generation

Generate CUDA® code for NVIDIA® GPUs using GPU Coder™.

Usage notes and limitations:

- GPU code generation for nonuniform grid sample method is not optimized.
- For the random downsample method, GPU Coder uses the NVIDIA CUDA random library (cuRAND) to generate the random numbers. Because of architectural and implementation differences between the random number generators on the GPU and CPU, numerical verification does not always match.

See Also

Functions

pcplayer | pcshow | pcwrite | pcread | pcfitplane | pcmerge | pctransform |
pcregistericp | pcregisterndt | pcdenoise

Objects

pointCloud | planeModel | affine3d

Topics

“3-D Point Cloud Registration and Stitching”

Introduced in R2015a

pcread

Read 3-D point cloud from PLY or PCD file

Syntax

```
ptCloud = pcread(filename)
```

Description

`ptCloud = pcread(filename)` reads a point cloud from the PLY or PCD file specified by the input filename. The function returns a `pointCloud` object, `ptCloud`.

Examples

Read Point Cloud from a PLY File

```
ptCloud = pcread('teapot.ply');  
pcshow(ptCloud);
```

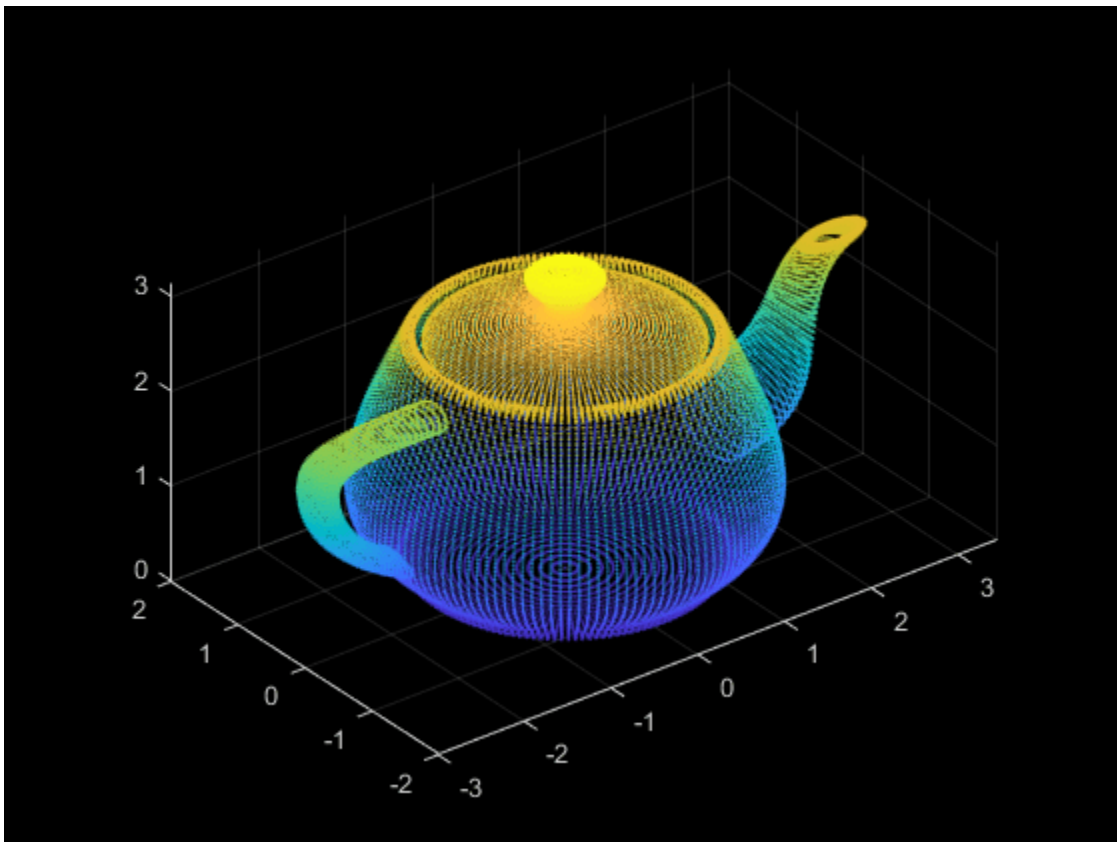

Input Arguments

filename — File name

character vector | string scalar

File name, specified as a character vector or a string scalar. The input file type must be a PLY or a PCD format file.

The polygon (PLY) file format, also known as the Stanford triangle format stores three-dimensional data from 3-D scanners. It is a format for storing graphical objects that are described as a collection of polygons. A PLY file consists of a header, followed by a list of vertices and then, a list of polygons. The header specifies how many vertices and polygons are in the file. It also states what properties are associated with each vertex, such as (x,y,z) coordinates, normals, and color. The file format has two sub-formats: an ASCII representation and a binary version for compact storage and for rapid saving and loading. The header of both ASCII and binary files is ASCII text. Only the numeric data that follows the header is different between the two versions. See “The PLY Format” for details on the contents of a PLY file.

The point cloud data (PCD) file format also stores three-dimensional data. It was created by the authors of the widely used point cloud library (PCL) to accommodate additional point cloud data requirements. See The PCD (Point Cloud Data) file format.

Note This function only supports PCD file formats saved in version 0.7 (PCD_V7). It also only supports the header entries with the COUNT entry set to 1. It does not support the COUNT entry set to a feature descriptor.

Output Arguments

ptCloud — Object for storing point cloud

pointCloud object

Object for storing point cloud, returned as a pointCloud object that contains the following PLY or PCD fields:

- Location property, stores the x , y , and z values.
- Color property, stores the red, green, and blue values.
- Normal property, stores the normal vectors for each point.
- Intensity property, stores the grayscale intensity for each point.

See Also

pointCloud | pcplayer | pcshow | pcwrite | pcmerge | pcfitplane | planeModel | pctransform | pcdsample | pcdnoise | pcregistericp

Topics

“3-D Point Cloud Registration and Stitching”

“The PLY Format”

External Websites

The PCD (Point Cloud Data) file format

Introduced in R2015a

pcregistericp

Register two point clouds using ICP algorithm

Syntax

```
tform = pcregistericp(moving, fixed)
[tform, movingReg] = pcregistericp(moving, fixed)
[ ___, rmse] = pcregistericp(moving, fixed)
[ ___ ] = pcregistericp(moving, fixed, Name, Value)
```

Description

`tform = pcregistericp(moving, fixed)` returns a rigid transformation that registers a moving point cloud to a fixed point cloud.

The registration algorithm is based on the "iterative closest point" (ICP) algorithm. Best performance of this iterative process requires adjusting properties for your data. Consider downsampling point clouds using `pcdownsample` before using `pcregistericp` to improve accuracy and efficiency of registration.

Point cloud normals are required by the registration algorithm when you select the `'pointToPlane'` metric. Therefore, if the input point cloud's `Normal` property is empty, the function fills it. When the function fills the `Normal` property, it uses 6 points to fit the local plane. Six points may not work under all circumstances. If registration with the `'pointToPlane'` metric fails, consider calling the `pcnormals` function which allows you to select the number of points to use.

`[tform, movingReg] = pcregistericp(moving, fixed)` additionally returns the transformed point cloud that aligns with the fixed point cloud.

`[___, rmse] = pcregistericp(moving, fixed)` additionally returns the root mean square error of the Euclidean distance between the inlier aligned points, using any of the preceding syntaxes.

`[___] = pcregistericp(moving, fixed, Name, Value)` uses additional options specified by one or more `Name, Value` pair arguments.

Examples

Align Two Point Clouds Using ICP Algorithm

Load point cloud data.

```
ptCloud = pcread('teapot.ply');

pcshow(ptCloud);
title('Teapot');
```

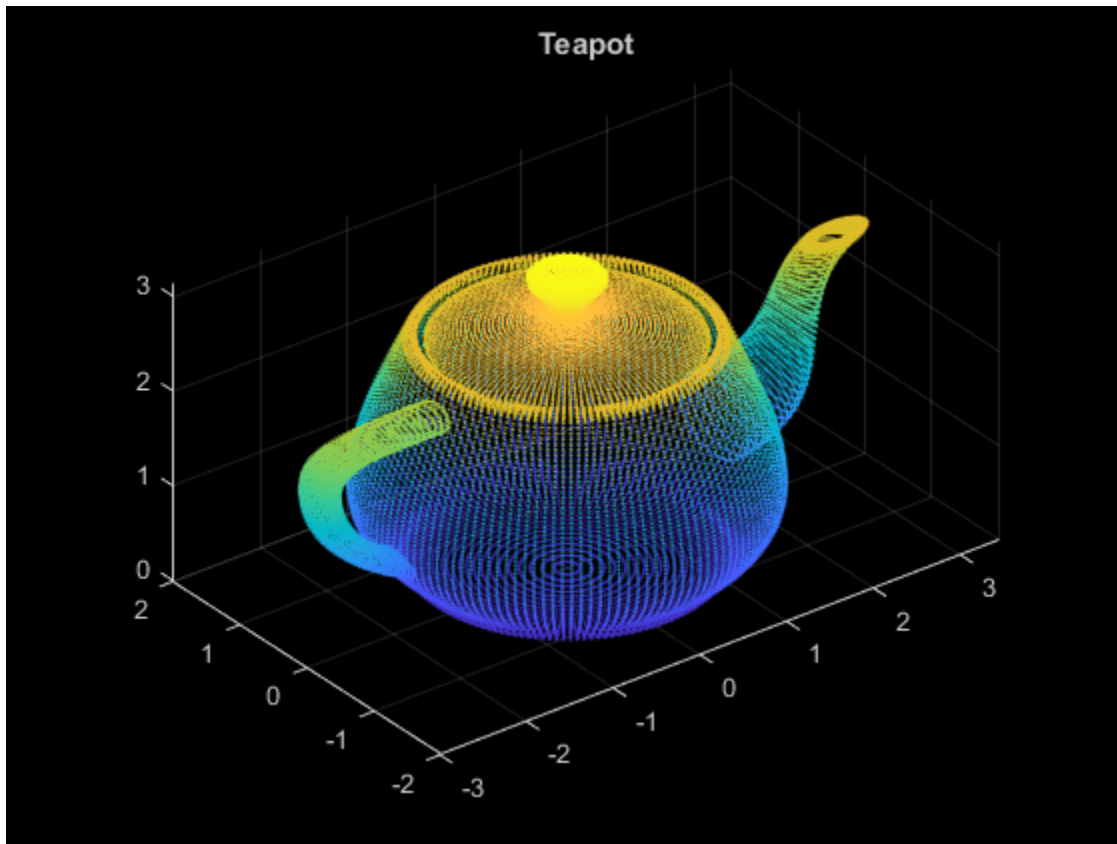

Create a transform object with 30 degree rotation along z -axis and translation [5,5,10].

```
A = [cos(pi/6) sin(pi/6) 0 0; ...  
     -sin(pi/6) cos(pi/6) 0 0; ...  
       0         0 1 0; ...  
       5         5 10 1];  
tform1 = affine3d(A);
```

Transform the point cloud.

```
ptCloudTformed = pctransform(ptCloud,tform1);  
  
pcshow(ptCloudTformed);  
title('Transformed Teapot');
```

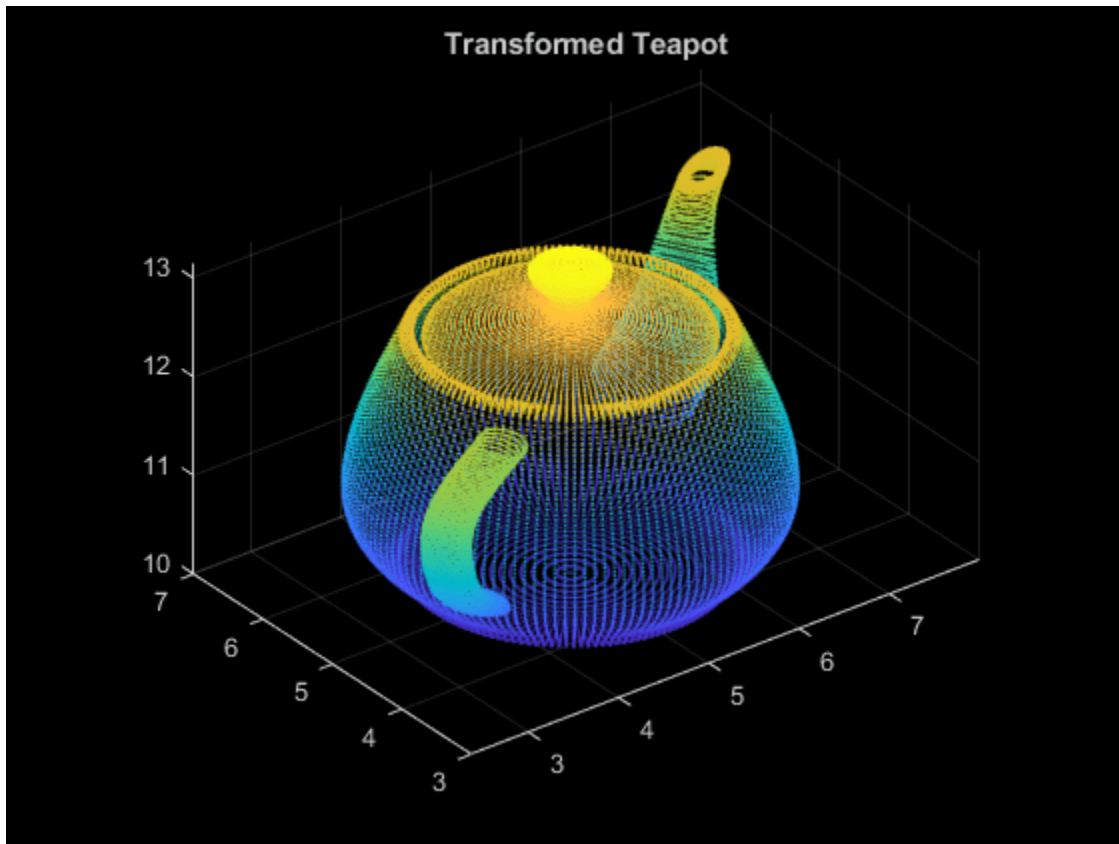

Apply the rigid registration.

```
tform = pcregistericp(ptCloudTformed,ptCloud, 'Extrapolate',true);
```

Compare the result with the true transformation.

```
disp(tform1.T);
```

```
    0.8660    0.5000         0         0
   -0.5000    0.8660         0         0
         0         0    1.0000         0
    5.0000    5.0000   10.0000    1.0000
```

```
tform2 = invert(tform);
```

```
disp(tform2.T);
```

```
    0.8660    0.5000    0.0000         0
   -0.5000    0.8660    0.0000         0
   -0.0000   -0.0000    1.0000         0
    5.0000    5.0000   10.0000    1.0000
```

Input Arguments

moving — Moving point cloud

pointCloud object

Moving point cloud, specified as a pointCloud object.

fixed — Fixed point cloud

pointCloud object

Fixed point cloud, specified as a pointCloud object.

Name-Value Pair Arguments

Specify optional comma-separated pairs of Name, Value arguments. Name is the argument name and Value is the corresponding value. Name must appear inside quotes. You can specify several name and value pair arguments in any order as Name1, Value1, ..., NameN, ValueN.

Example: 'Metric', 'pointToPoint' sets the metric for the ICP algorithm to the 'pointToPoint' character vector.

Metric — Minimization metric

'pointToPoint' (default) | 'pointToPlane'

Minimization metric, specified as the comma-separated pair consisting of 'Metric' and the 'pointToPoint' or 'pointToPlane' character vector. The rigid transformation between the moving and fixed point clouds are estimated by the iterative closest point (ICP) algorithm. The ICP algorithm minimizes the distance between the two point clouds according to the given metric.

Setting 'Metric' to 'pointToPlane' can reduce the number of iterations to process. However, this metric requires extra algorithmic steps within each iteration. The 'pointToPlane' metric improves the registration of planar surfaces.

Downsample Method Selection:

Downsample the point clouds using the pcdsample function. Use either the 'random' or 'gridAverage' input for the pcdsample function according to the Metric table below.

Metric	Moving PointCloud Downsample Method	Fixed Point Cloud Downsample Method
'pointToPoint'	'random'	'random'
	'gridAverage'	'gridAverage'
'pointToPlane'	'gridAverage'	'gridAverage'
	'random'	'nonuniformGridSample'

Extrapolate — Extrapolation

false (default) | true

Extrapolation, specified as the comma-separated pair consisting of 'Extrapolate' and the boolean true or false. When you set this property to true, the function adds an extrapolation step that traces out a path in the registration state space, that is described in [2]. Setting this property to true can reduce the number of iterations to converge.

InlierRatio — Percentage of inliers

1 (default) | scalar

Percentage of inliers, specified as the comma-separated pair consisting of 'InlierRatio' and a scalar value. Use this value to set a percentage of matched pairs as inliers. A pair of matched points is considered an inlier if its Euclidean distance falls within the percentage set of matching distances. By default, all matching pairs are used.

MaxIterations — Maximum number of iterations`20 (default) | positive integer`

Maximum number of iterations, specified as the comma-separated pair consisting of 'MaxIterations' and a positive integer. This value specifies the maximum number of iterations before ICP stops.

Tolerance — Tolerance between consecutive ICP iterations`[0.01, 0.05] (default) | 2-element vector`

Tolerance between consecutive ICP iterations, specified as the comma-separated pair consisting of 'Tolerance' and a 2-element vector. The 2-element vector, $[Tdiff, Rdiff]$, represents the tolerance of absolute difference in translation and rotation estimated in consecutive ICP iterations. $Tdiff$ measures the Euclidean distance between two translation vectors. $Rdiff$ measures the angular difference in degrees. The algorithm stops when the average difference between estimated rigid transformations in the three most recent consecutive iterations falls below the specified tolerance value.

InitialTransform — Initial rigid transformation`rigid3d object`

Initial rigid transformation, specified as the comma-separated pair consisting of 'InitialTransform' and a `rigid3d` object. The initial rigid transformation is useful when you provide an external coarse estimation.

The `rigid3d` object contains a translation that moves the center of the moving point cloud to the center of the fixed point cloud.

Verbose — Display progress information`true (default) | false`

Display progress information, specified as the comma-separated pair consisting of 'Verbose' and a logical scalar. Set `Verbose` to `true` to display progress information.

Output Arguments**tform — Rigid transformation**`rigid3d object`

Rigid transformation, returned as a `rigid3d` object. The rigid transformation registers a moving point cloud to a fixed point cloud. The `rigid3d` object describes the rigid 3-D transform. The iterative closest point (ICP) algorithm estimates the rigid transformation between the moving and fixed point clouds.

movingReg — Transformed point cloud`pointCloud object`

Transformed point cloud, returned as a `pointCloud` object. The transformed point cloud is aligned with the fixed point cloud.

rmse — Root mean square error`positive numeric`

Root mean square error, returned as a positive numeric value that represents the Euclidean distance between the inlier aligned points.

Algorithms

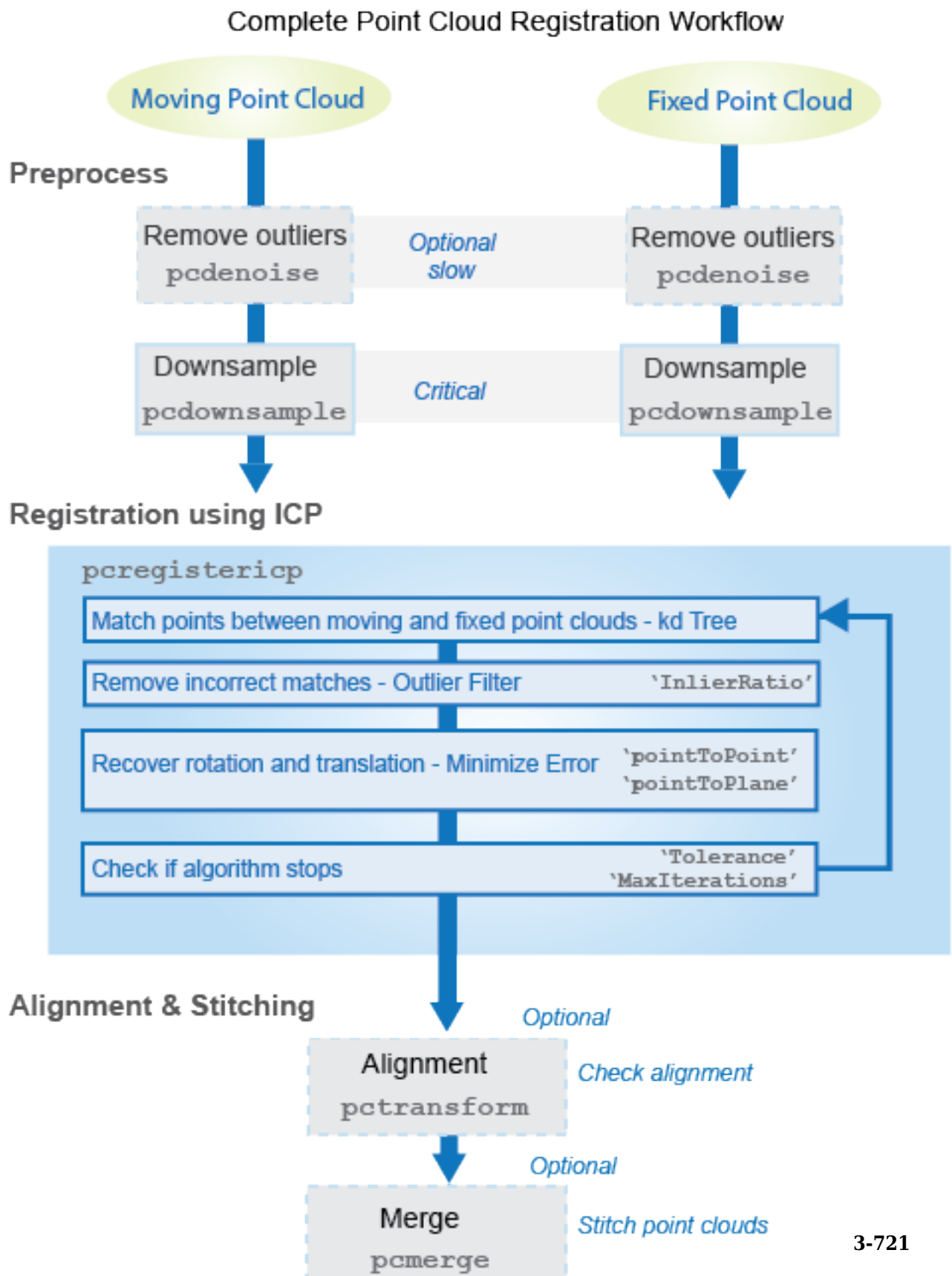

Tips

- For ground vehicle point clouds, you can improve performance and accuracy by removing the ground using `pcfitplane` or `segmentGroundFromLidarData` before registration. For details on how to do this, see the helper function, `helperProcessPointCloud` in the “Build a Map from Lidar Data” (Automated Driving Toolbox) example.
- To merge more than two point clouds, you can use `pccat` function instead of the `pcmerge` function.

Compatibility Considerations**The `pcregistericp` function returns a `rigid3d` object**

Behavior changed in R2020a

Starting in R2020a, the `pcregistericp` function returns a `rigid3d` object. Prior to R2020a, the function returned an `affine3d` object.

References

- [1] Chen, Y. and G. Medioni. “Object Modelling by Registration of Multiple Range Images.” *Image Vision Computing*. Butterworth-Heinemann . Vol. 10, Issue 3, April 1992, pp. 145-155.
- [2] Besl, Paul J., N. D. McKay. “A Method for Registration of 3-D Shapes.” *IEEE Transactions on Pattern Analysis and Machine Intelligence*. Los Alamitos, CA: IEEE Computer Society. Vol. 14, Issue 2, 1992, pp. 239-256.

See Also**Functions**

`pcregistercorr` | `pcregisterndt` | `pcregistercpd` | `pctransform` | `pcshow` | `pcshowpair` | `pcdownsample` | `pcfitplane` | `pcdenoise` | `pcmerge`

Objects

`pointCloud` | `rigid3d`

Topics

“3-D Point Cloud Registration and Stitching”
“Implement Point Cloud SLAM in MATLAB”

Introduced in R2018a

pcregisterndt

Register two point clouds using NDT algorithm

Syntax

```
tform = pcregisterndt(moving, fixed, gridStep)
[tform, movingReg] = pcregisterndt(moving, fixed, gridStep)
[ ___, rmse] = pcregisterndt(moving, fixed, gridStep)
[ ___ ] = pcregisterndt(moving, fixed, gridStep, Name, Value)
```

Description

`tform = pcregisterndt(moving, fixed, gridStep)` returns the rigid transformation that registers the moving point cloud with the fixed point cloud. The point clouds are voxelized into cubes of size `gridStep`.

The registration algorithm is based on the normal-distributions transform (NDT) algorithm [1] [2]. Best performance of this iterative process requires adjusting properties for your data. To improve accuracy and efficiency of registration, consider downsampling the point clouds by using `pcdownsample` before using `pcregisterndt`.

`[tform, movingReg] = pcregisterndt(moving, fixed, gridStep)` also returns the transformed point cloud that aligns with the fixed point cloud.

`[___, rmse] = pcregisterndt(moving, fixed, gridStep)` also returns the root mean square error of the Euclidean distance between the aligned point clouds, using any of the preceding syntaxes.

`[___] = pcregisterndt(moving, fixed, gridStep, Name, Value)` uses additional options specified by one or more `Name, Value` pair arguments.

Examples

Align Two Point Clouds Using NDT Algorithm

Load point cloud data.

```
ld = load('livingRoom.mat');
moving = ld.livingRoomData{1};
fixed = ld.livingRoomData{2};
pcshowpair(moving, fixed, 'VerticalAxis', 'Y', 'VerticalAxisDir', 'Down')
```

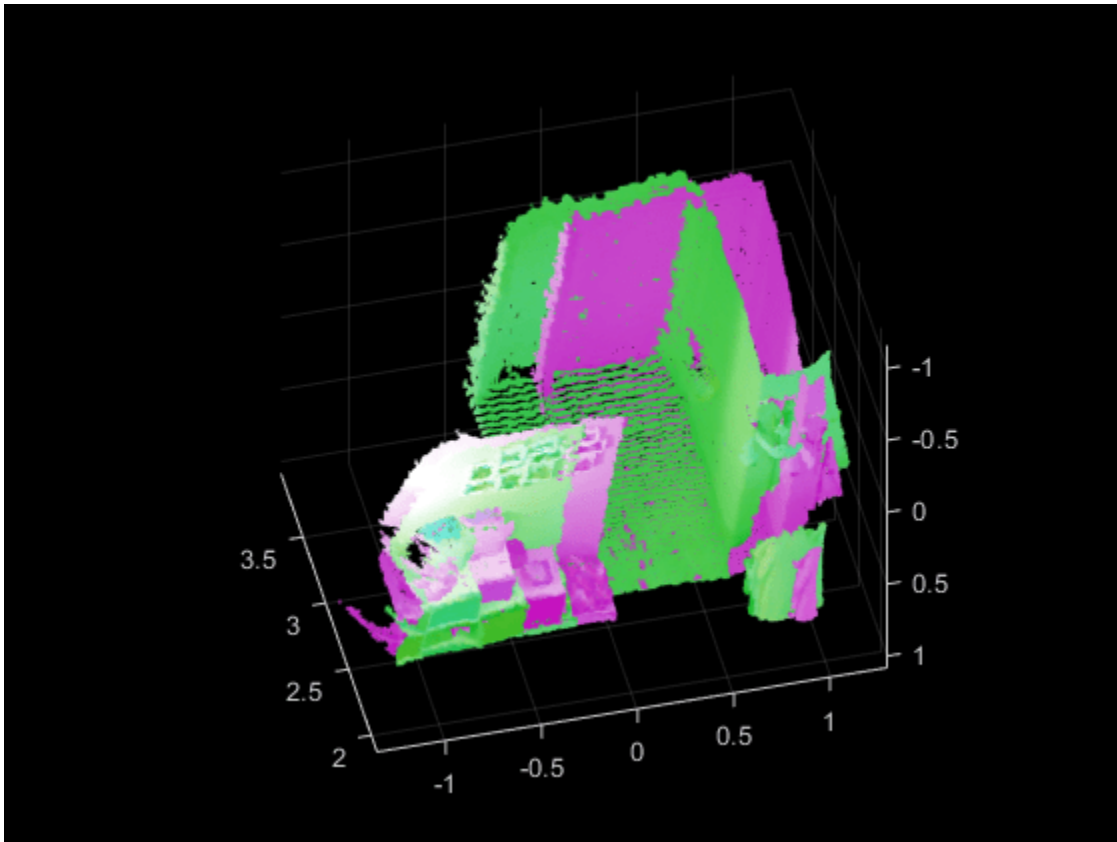

To improve the efficiency and accuracy of the NDT registration algorithm, downsample the moving point cloud.

```
movingDownsampled = pcdsample(moving, 'gridAverage', 0.1);
```

Voxelize the point cloud into cubes of sidelength 0.5. Apply the rigid registration using the NDT algorithm.

```
gridStep = 0.5;  
tform = pcregisterndt(movingDownsampled, fixed, gridStep);
```

Visualize the alignment.

```
movingReg = pctransform(moving, tform);  
pcshowpair(movingReg, fixed, 'VerticalAxis', 'Y', 'VerticalAxisDir', 'Down')
```

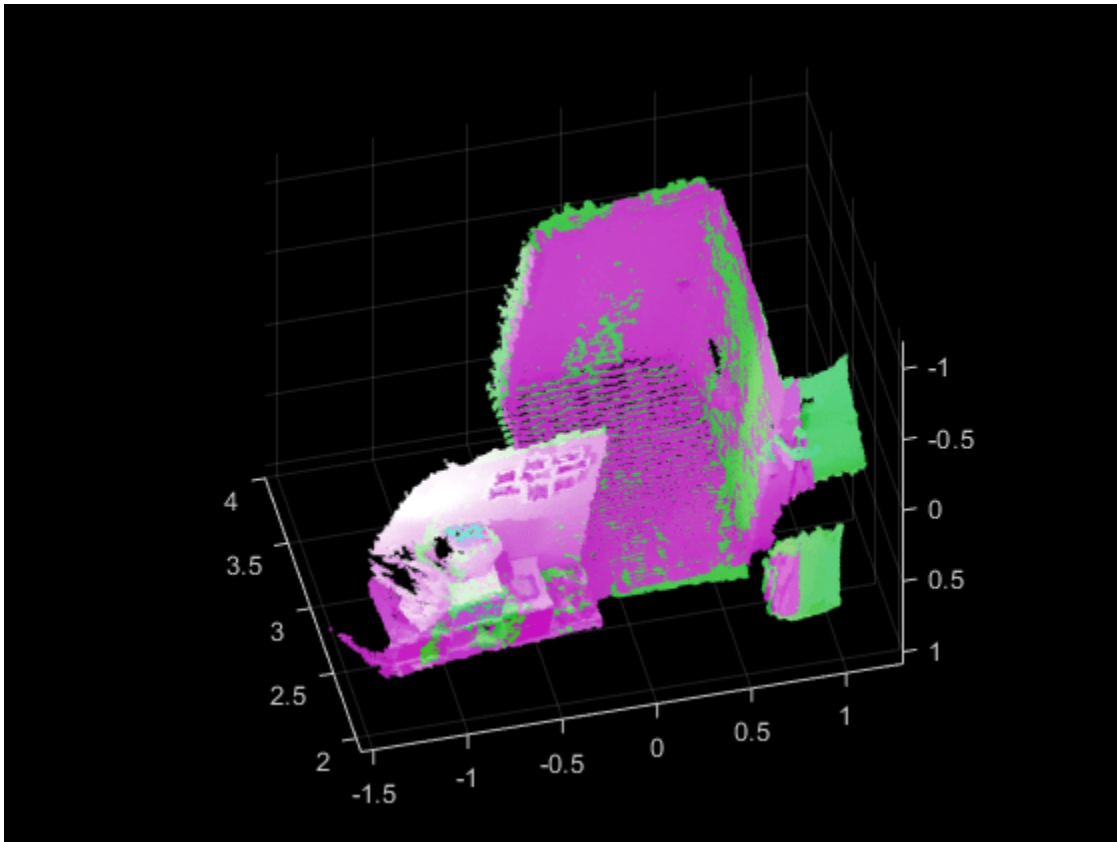

Input Arguments

moving — Moving point cloud

`pointCloud` object

Moving point cloud, specified as a `pointCloud` object.

fixed — Fixed point cloud

`pointCloud` object

Fixed point cloud, specified as a `pointCloud` object.

gridStep — Size of voxels

positive scalar

Size of the 3-D cube that voxelizes the fixed point cloud, specified as a positive scalar.

Data Types: `single` | `double`

Name-Value Pair Arguments

Specify optional comma-separated pairs of `Name`, `Value` arguments. `Name` is the argument name and `Value` is the corresponding value. `Name` must appear inside quotes. You can specify several name and value pair arguments in any order as `Name1`, `Value1`, ..., `NameN`, `ValueN`.

Example: `'MaxIterations', 20` stops the NDT algorithm after 20 iterations.

InitialTransform — Initial rigid transformation`rigid3d` object

Initial rigid transformation, specified as the comma-separated pair consisting of 'InitialTransform' and a `rigid3d` object. The initial rigid transformation is useful when you provide an external coarse estimation.

The `rigid3d` object contains a translation that moves the center of the moving point cloud to the center of the fixed point cloud.

OutlierRatio — Percentage of outliers`0.55` (default) | scalar in the range [0, 1)

Expected percentage of outliers with respect to a normal distribution, specified as the comma-separated pair consisting of 'OutlierRatio' and a scalar in the range [0, 1). The NDT algorithm assumes a point is generated by a mixture of a normal distribution for inliers and a uniform distribution for outliers. A larger value of 'OutlierRatio' reduces the influence of outliers.

Data Types: `single` | `double`

MaxIterations — Maximum number of iterations`30` (default) | nonnegative integer

Maximum number of iterations before NDT stops, specified as the comma-separated pair consisting of 'MaxIterations' and a nonnegative integer.

Data Types: `single` | `double`

Tolerance — Tolerance between consecutive NDT iterations`[0.01 0.5]` (default) | 2-element vector

Tolerance between consecutive NDT iterations, specified as the comma-separated pair consisting of 'Tolerance' and a 2-element vector with nonnegative values. The vector, [*Tdiff* *Rdiff*], represents the tolerance of absolute difference in translation and rotation estimated in consecutive NDT iterations. *Tdiff* measures the Euclidean distance between two translation vectors. *Rdiff* measures the angular difference in degrees. The algorithm stops when the difference between estimated rigid transformations in the most recent consecutive iterations falls below the specified tolerance value.

Data Types: `single` | `double`

Verbose — Display progress information`false` (default) | `true`

Display progress information, specified as the comma-separated pair consisting of 'Verbose' and a logical scalar. Set `Verbose` to `true` to display progress information.

Data Types: `logical`

Output Arguments**tform — Rigid transformation**`rigid3d` object

Rigid transformation, returned as a `rigid3d` object. `tform` describes the rigid 3-D transformation that registers the moving point cloud, `moving`, to the fixed point cloud, `fixed`.

movingReg — Transformed point cloud

pointCloud object

Transformed point cloud, returned as a pointCloud object. The transformed point cloud is aligned with the fixed point cloud, fixed.

rmse — Root mean square error

positive number

Root mean square error, returned as a positive number. rmse is the Euclidean distance between the aligned point clouds.

Algorithms

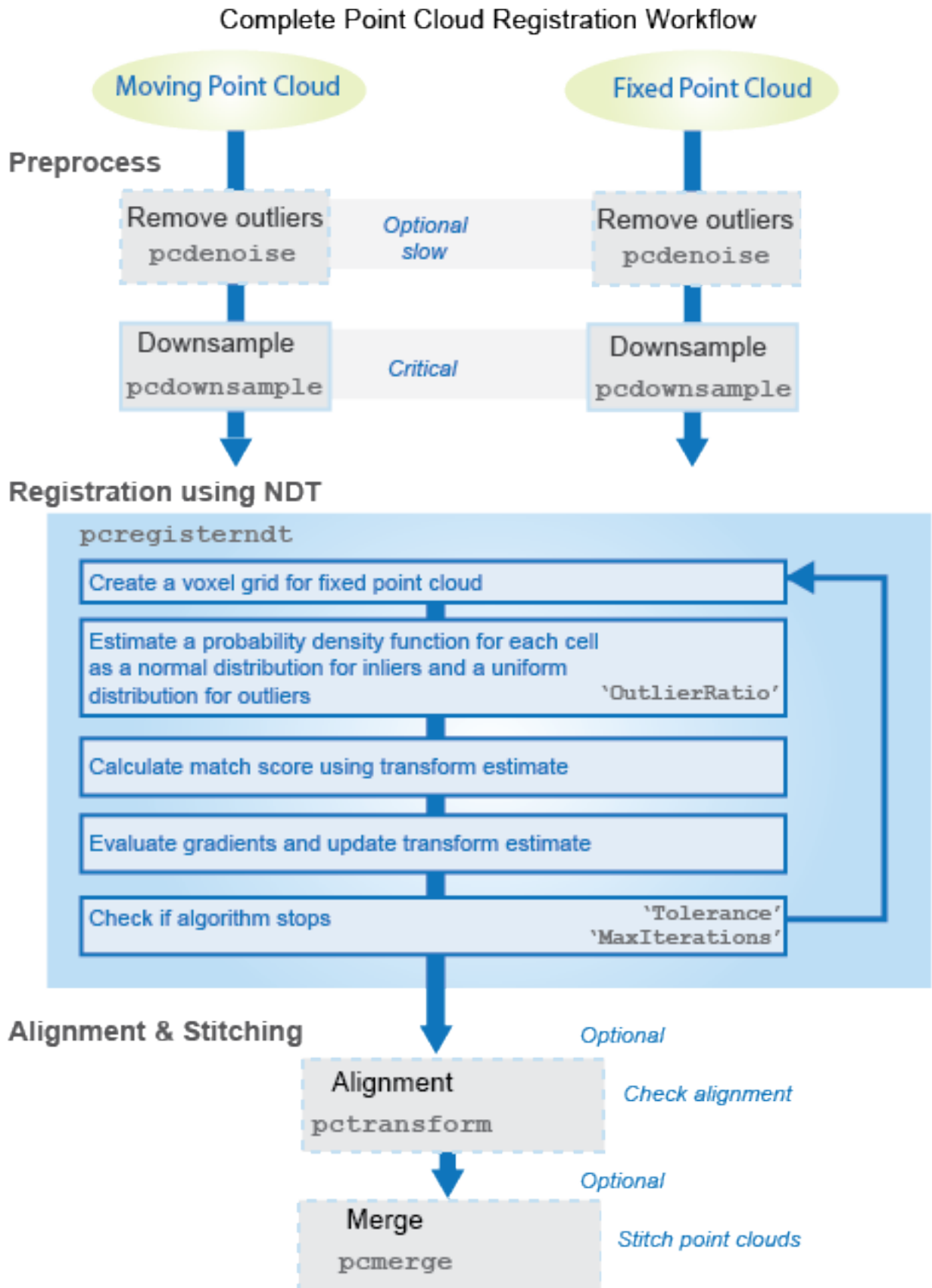

Tips

- For ground vehicle point clouds, you can improve performance and accuracy by removing the ground using `pcfitplane` or `segmentGroundFromLidarData` before registration. For details on how to do this, see the helper function, `helperProcessPointCloud` in the “Build a Map from Lidar Data” (Automated Driving Toolbox) example.
- To merge more than two point clouds, you can use `pccat` function instead of the `pcmerge` function.

NDT Registration Overview

The NDT registration is based on normal distributions rather than other types of registration which match points or lines in order to find the transformation between two point clouds. The NDT approach uses statistical models with 3-D boxes, called voxels.

To register two point clouds, a moving point cloud and a fixed point cloud, using the NDT approach, the algorithm performs the following:

- 1 Computes the normal distributions for the fixed point cloud by dividing the area covered by the point cloud scan into 3-D boxes of constant size, referred to as "voxels". Each voxel contains a set of points. The algorithm computes the mean and covariance matrix for the points in each voxel.
- 2 Starting with an initial guess of the transformation, the algorithm aligns the moving point cloud to the fixed point cloud. It then finds the sum of the statistical likelihood of each aligned point to be located in the voxel that surrounds the point (in the moving point cloud), based on the normal distribution of the fixed point cloud.
- 3 To improve the registration, the algorithm maximizes the probability score of the moving point cloud on the normal distributions of the fixed point cloud. This is done by iteratively optimizing angular and translational estimations.
- 4 Repeats the alignment of the moving point cloud with the fixed point cloud using the new transformation from the previous step and then repeats the optimization.
- 5 The algorithm stops once the maximum iterations or the tolerance parameters, are met. The tolerance is a measure of how much the angular and translational estimations change from one iteration to another.

Compatibility Considerations

The `pcregisterndt` function returns a `rigid3d` object

Behavior changed in R2020a

Starting in R2020a, the `pcregisterndt` function returns a `rigid3d` object. Prior to R2020a, the function returned an `affine3d` object.

References

- [1] Biber, P., and W. Straßer. “The Normal Distributions Transform: A New Approach to Laser Scan Matching.” *Proceedings of IEEE/RSJ International Conference on Intelligent Robots and Systems (IROS)*. Las Vegas, NV. Vol. 3, November 2003, pp. 2743-2748.
- [2] Magnusson, M. “The Three-Dimensional Normal-Distributions Transform — an Efficient Representation for Registration, Surface Analysis, and Loop Detection.” Ph.D. Thesis. Örebro University, Örebro, Sweden, 2013.

Extended Capabilities

C/C++ Code Generation

Generate C and C++ code using MATLAB® Coder™.

GPU Code Generation

Generate CUDA® code for NVIDIA® GPUs using GPU Coder™.

See Also

Functions

`pcregistercorr` | `pcregistericp` | `pcregistercpd` | `pctransform` | `pcshow` | `pcshowpair` | `pcdownsample` | `pcfitplane` | `pcdenoise` | `pcmerge`

Objects

`pointCloud` | `rigid3d`

Topics

“3-D Point Cloud Registration and Stitching”

“Implement Point Cloud SLAM in MATLAB”

Introduced in R2018a

pcregrigid

Register two point clouds using ICP algorithm

Note pcregrigid is not recommended. Use pcregistericp instead.

Syntax

```
tform = pcregrigid(moving, fixed)
[tform, movingReg] = pcregrigid(moving, fixed)
[ ___, rmse] = pcregrigid(moving, fixed)
[ ___ ] = pcregrigid(moving, fixed, Name, Value)
```

Description

`tform = pcregrigid(moving, fixed)` returns a rigid transformation that registers a moving point cloud to a fixed point cloud.

The registration algorithm is based on the "iterative closest point" (ICP) algorithm. Best performance of this iterative process requires adjusting properties for your data. Consider downsampling point clouds using `pcdownsample` before using `pcregrigid` to improve accuracy and efficiency of registration.

Point cloud normals are required by the registration algorithm when you select the 'pointToPlane' metric. Therefore, if the input point cloud's `Normal` property is empty, the function fills it. When the function fills the `Normal` property, it uses 6 points to fit the local plane. Six points may not work under all circumstances. If registration with the 'pointToPlane' metric fails, consider calling the `pcnormals` function which allows you to select the number of points to use.

`[tform, movingReg] = pcregrigid(moving, fixed)` additionally returns the transformed point cloud that aligns with the fixed point cloud.

`[___, rmse] = pcregrigid(moving, fixed)` additionally returns the root mean squared error of the Euclidean distance between the aligned point clouds, using any of the preceding syntaxes.

`[___] = pcregrigid(moving, fixed, Name, Value)` uses additional options specified by one or more `Name, Value` pair arguments.

Examples

Align Two Point Clouds

Load point cloud data.

```
ptCloud = pcread('teapot.ply');
figure
pcshow(ptCloud);
title('Teapot');
```

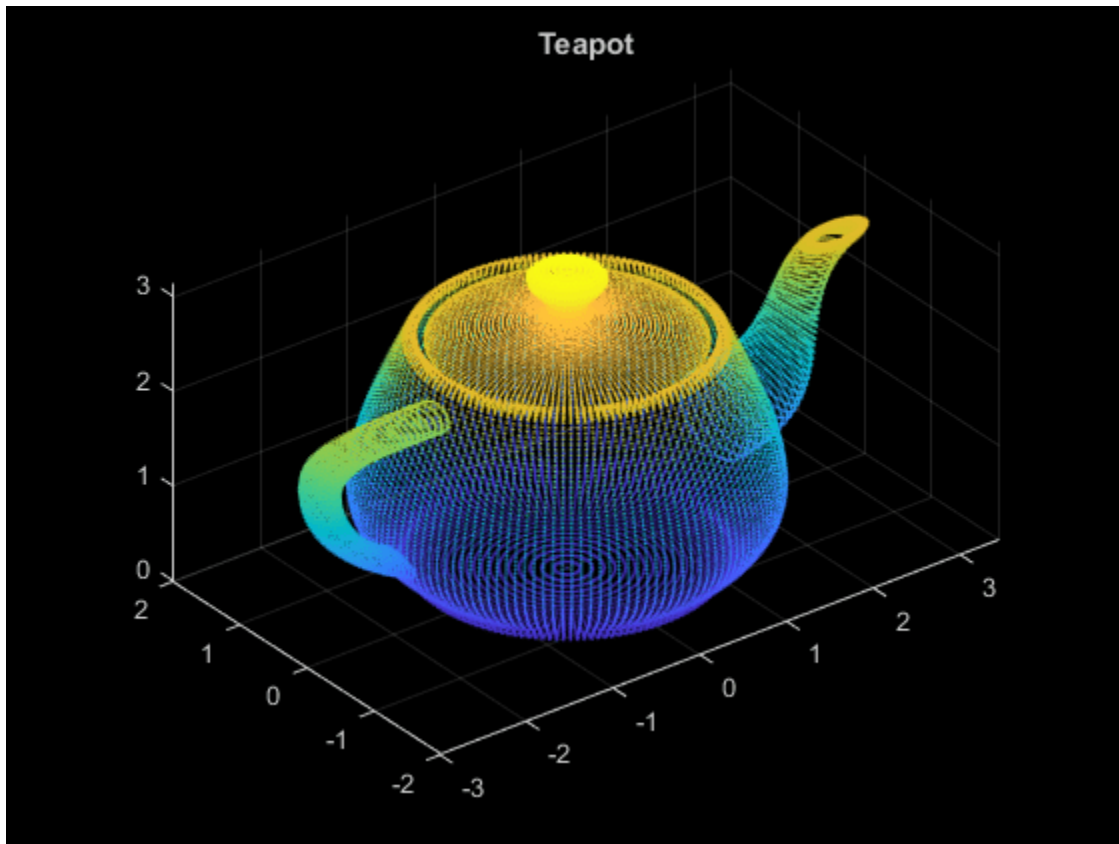

Create a transform object with 30 degree rotation along z -axis and translation [5,5,10].

```
A = [cos(pi/6) sin(pi/6) 0 0; ...  
     -sin(pi/6) cos(pi/6) 0 0; ...  
      0         0     1 0; ...  
      5         5    10 1];  
tform1 = affine3d(A);
```

Transform the point cloud.

```
ptCloudTformed = pctransform(ptCloud,tform1);
```

```
figure  
pcshow(ptCloudTformed);  
title('Transformed Teapot');
```

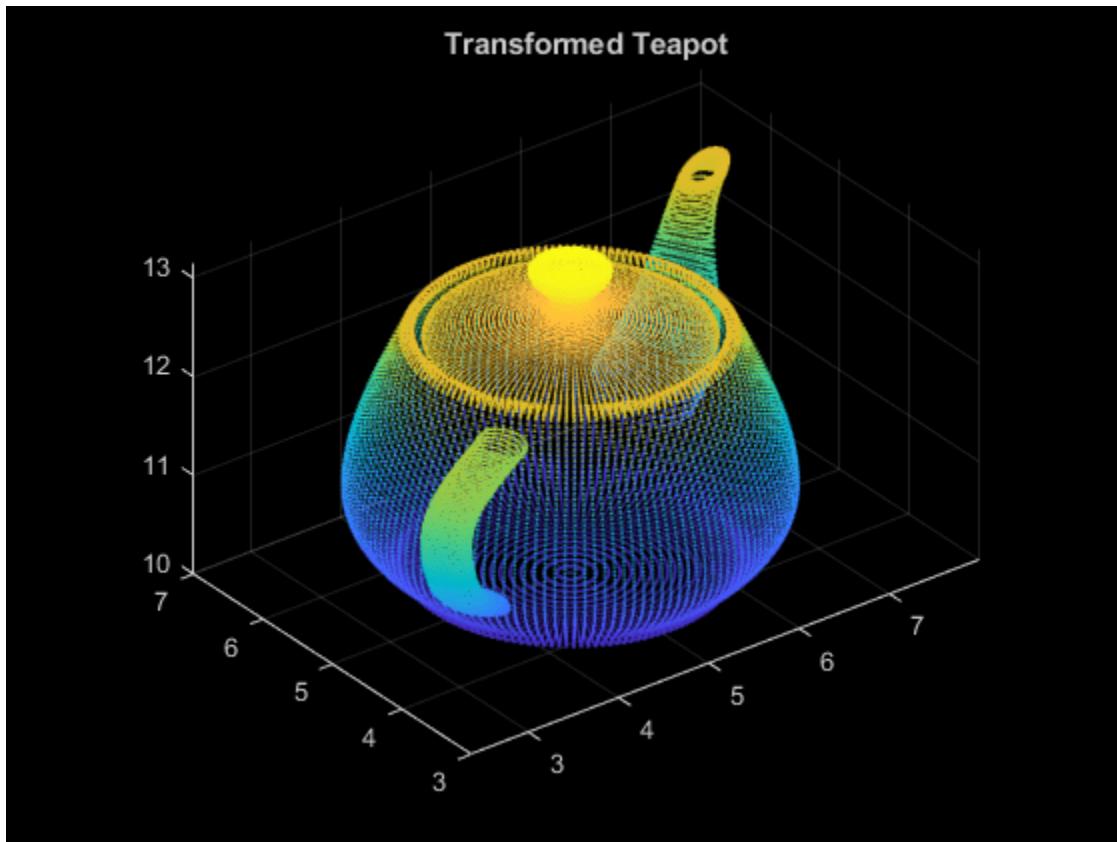

Apply the rigid registration.

```
tform = pcregrigid(ptCloudTformed,ptCloud,'Extrapolate',true);
```

Compare the result with the true transformation.

```
disp(tform1.T);
```

```
    0.8660    0.5000         0         0
   -0.5000    0.8660         0         0
         0         0    1.0000         0
    5.0000    5.0000   10.0000    1.0000
```

```
tform2 = invert(tform);
```

```
disp(tform2.T);
```

```
    0.8660    0.5000    0.0000         0
   -0.5000    0.8660    0.0000         0
   -0.0000   -0.0000    1.0000         0
    5.0000    5.0000   10.0000    1.0000
```

Input Arguments

moving — Moving point cloud

pointCloud object

Moving point cloud, specified as a pointCloud object.

fixed — Fixed point cloud

pointCloud object

Fixed point cloud, specified as a pointCloud object.

Name-Value Pair Arguments

Specify optional comma-separated pairs of Name, Value arguments. Name is the argument name and Value is the corresponding value. Name must appear inside quotes. You can specify several name and value pair arguments in any order as Name1, Value1, ..., NameN, ValueN.

Example: 'Metric', 'pointToPoint' sets the metric for the ICP algorithm to the 'pointToPoint'.

Metric — Minimization metric

'pointToPoint' (default) | 'pointToPlane'

Minimization metric, specified as the comma-separated pair consisting of 'Metric' and 'pointToPoint' or 'pointToPlane'. The rigid transformation between the moving and fixed point clouds are estimated by the iterative closest point (ICP) algorithm. The ICP algorithm minimizes the distance between the two point clouds according to the given metric.

Setting 'Metric' to 'pointToPlane' can reduce the number of iterations to process. However, this metric requires extra algorithmic steps within each iteration. The 'pointToPlane' metric improves the registration of planar surfaces.

Downsample Method Selection:

Downsample the point clouds using the pcdsample function. Use either the 'random' or 'gridAverage' input for the pcdsample function according to the Metric table below.

Metric	Point Cloud A Downsample Method	Point Cloud B Downsample Method
'pointToPoint'	'random'	'random'
	'gridAverage'	'gridAverage'
'pointToPlane'	'gridAverage'	'gridAverage'
	'random'	'nonuniformGridSample'

Extrapolate — Extrapolation

false (default) | true

Extrapolation, specified as the comma-separated pair consisting of 'Extrapolate' and the boolean true or false. When you set this property to true, the function adds an extrapolation step that traces out a path in the registration state space, that is described in [2]. Setting this property to true can reduce the number of iterations to converge.

InlierRatio — Percentage of inliers

1 (default) | scalar

Percentage of inliers, specified as the comma-separated pair consisting of 'InlierRatio' and a scalar value. Use this value to set a percentage of matched pairs as inliers. A pair of matched points is considered an inlier if its Euclidean distance falls within the percentage set of matching distances. By default, all matching pairs are used.

MaxIterations — Maximum number of iterations

20 (default) | positive integer

Maximum number of iterations, specified as the comma-separated pair consisting of 'MaxIterations' and a positive integer. This value specifies the maximum number of iterations before ICP stops.

Tolerance — Tolerance between consecutive ICP iterations

[0.01, 0.009] (default) | 2-element vector

Tolerance between consecutive ICP iterations, specified as the comma-separated pair consisting of 'Tolerance' and a 2-element vector. The 2-element vector, [*Tdiff*, *Rdiff*], represents the tolerance of absolute difference in translation and rotation estimated in consecutive ICP iterations. *Tdiff* measures the Euclidean distance between two translation vectors. *Rdiff* measures the angular difference in radians. The algorithm stops when the average difference between estimated rigid transformations in the three most recent consecutive iterations falls below the specified tolerance value.

InitialTransform — Initial rigid transformation

`affine3d()` object (default)

Initial rigid transformation, specified as the comma-separated pair consisting of 'InitialTransform' and an `affine3d` object. The initial rigid transformation is useful when you provide an external coarse estimation.

Verbose — Display progress information

`true` (default) | `false`

Display progress information, specified as the comma-separated pair consisting of 'Verbose' and a logical scalar. Set `Verbose` to `true` to display progress information.

Output Arguments

tform — Rigid transformation

`affine3d` object

Rigid transformation, returned as an `affine3d` object. The rigid transformation registers a moving point cloud to a fixed point cloud. The `affine3d` object describes the rigid 3-D transform. The iterative closest point (ICP) algorithm estimates the rigid transformation between the moving and fixed point clouds.

movingReg — Transformed point cloud

`pointCloud` object

Transformed point cloud, returned as a `pointCloud` object. The transformed point cloud is aligned with the fixed point cloud.

rmse — Root mean square error

positive numeric

Root mean square error, returned as the Euclidean distance between the aligned point clouds.

References

- [1] Chen, Y. and G. Medioni. "Object Modelling by Registration of Multiple Range Images." *Image Vision Computing*. Butterworth-Heinemann . Vol. 10, Issue 3, April 1992, pp. 145-155.

[2] Besl, Paul J., N. D. McKay. "A Method for Registration of 3-D Shapes." *IEEE Transactions on Pattern Analysis and Machine Intelligence*. Los Alamitos, CA: IEEE Computer Society. Vol. 14, Issue 2, 1992, pp. 239-256.

See Also

pointCloud | pcregistericp | pcregisterndt

Topics

"3-D Point Cloud Registration and Stitching"

Introduced in R2015a

pcsegdist

Segment point cloud into clusters based on Euclidean distance

Syntax

```
labels = pcsegdist(ptCloud,minDistance)
[labels,numClusters] = pcsegdist(ptCloud,minDistance)
[ ___ ] = pcsegdist( ___ ,Name=Value)
```

Description

`labels = pcsegdist(ptCloud,minDistance)` segments a point cloud into clusters, with a minimum Euclidean distance of `minDistance` between points from different clusters. `pcsegdist` assigns an integer cluster label to each point in the point cloud, and returns the `labels` of all points.

`[labels,numClusters] = pcsegdist(ptCloud,minDistance)` also returns the number of clusters.

`[___] = pcsegdist(___ ,Name=Value)` sets properties using name-value arguments. For example, `labels = pcsegdist(ptCloud,minDistance,NumClusterPoints=[1,Inf])` sets the minimum and maximum number of points in each cluster to `[1,Inf]`.

Examples

Cluster Point Cloud Based on Euclidean Distance

Create two concentric spheres and combine them.

```
[X,Y,Z] = sphere(100);
loc1 = [X(:),Y(:),Z(:)];
loc2 = 2*loc1;
ptCloud = pointCloud([loc1;loc2]);
pcshow(ptCloud)
title('Point Cloud')
```

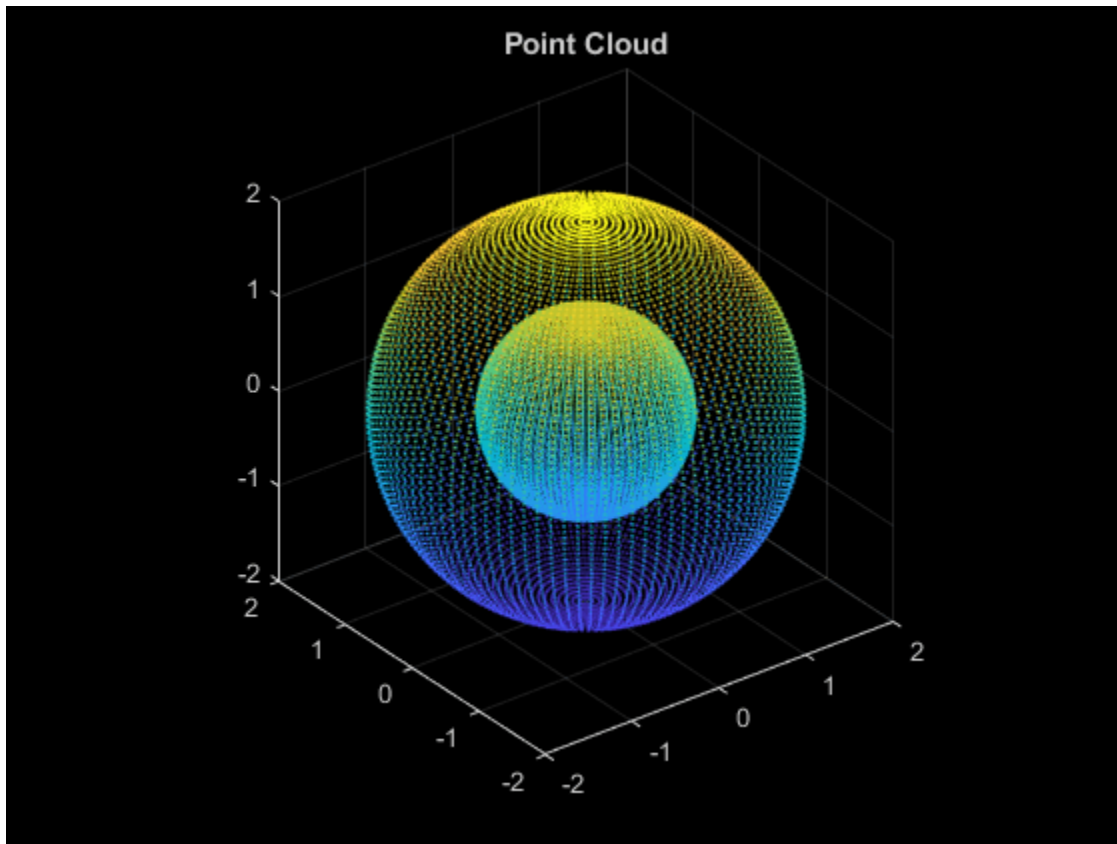

Set the minimum Euclidean distance between clusters.

```
minDistance = 0.5;
```

Segment the point cloud.

```
[labels,numClusters] = pcsegdist(ptCloud,minDistance);
```

Plot the labeled results. The points are grouped into two clusters.

```
pcshow(ptCloud.Location,labels)  
colormap(hsv(numClusters))  
title('Point Cloud Clusters')
```

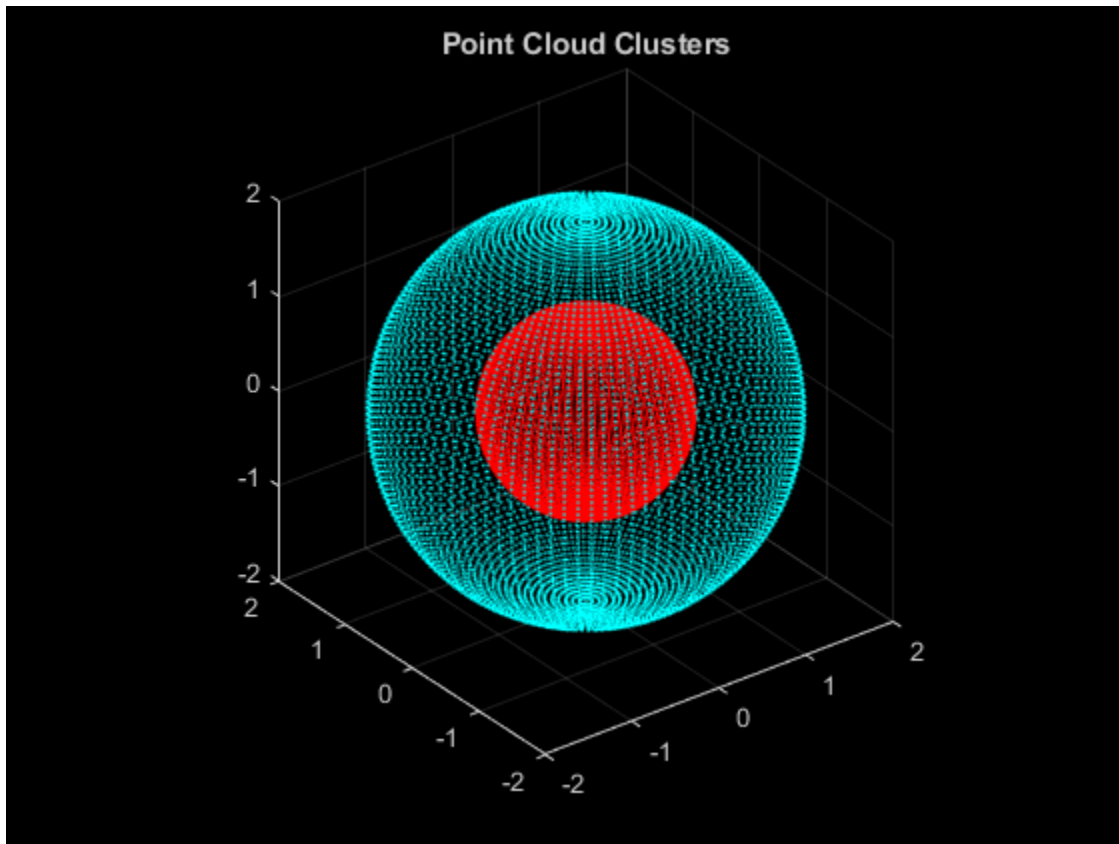
Cluster Lidar Point Cloud Based on Euclidean Distance

Load an organized lidar point cloud in the workspace.

```
ld = load('drivingLidarPoints.mat');
```

Detect the ground plane. Distance is measured in meters.

```
maxDistance = 0.9;
referenceVector = [0 0 1];
[~,inliers,outliers] = pcfitplane(ld.ptCloud,maxDistance,referenceVector);
```

Remove the ground plane points.

```
ptCloudWithoutGround = select(ld.ptCloud,outliers);
```

Cluster the point cloud with a minimum of 10 points per cluster.

```
minDistance = 2;
minPoints = 10;
[labels,numClusters] = pcsegdist(ptCloudWithoutGround,minDistance,'NumClusterPoints',minPoints);
```

Remove the points with a label value of 0.

```
idxValidPoints = find(labels);  
labelColorIndex = labels(idxValidPoints);  
segmentedPtCloud = select(ptCloudWithoutGround,idxValidPoints);
```

Plot the labeled results.

```
figure  
colormap(hsv(numClusters))  
pcshow(segmentedPtCloud.Location,labelColorIndex)  
title('Point Cloud Clusters')
```

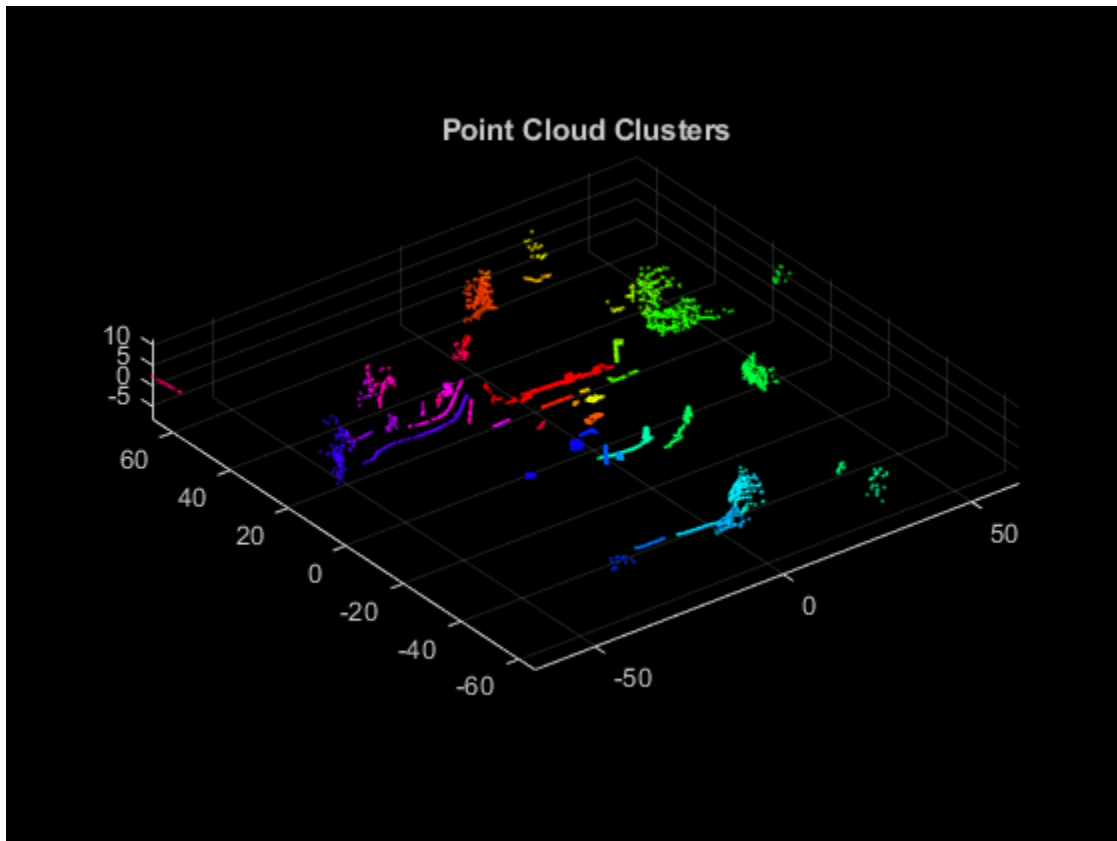

Input Arguments

ptCloud — Point cloud

pointCloud object

Point cloud, specified as a pointCloud object.

minDistance — Minimum Euclidean distance

positive scalar

Minimum Euclidean distance between points from two different clusters, specified as a positive scalar.

Data Types: single | double

Name-Value Pair Arguments

Specify optional pairs of arguments as `Name1=Value1, ..., NameN=ValueN`, where `Name` is the argument name and `Value` is the corresponding value. Name-value arguments must appear after other arguments, but the order of the pairs does not matter.

Example: `ParallelNeighborSearch=false` sets the `ParallelNeighborSearch` to `false`.

NumClusterPoints — Minimum and maximum number of points in each cluster

`[1, Inf]` (default) | 2-element vector | scalar

Minimum and maximum number of points in each cluster, specified as a scalar or a 2-element vector of the form `[minPoints,maxPoints]`. When you specify `NumClusterPoints` as a scalar, the maximum number of points in the cluster is unrestricted. The function sets labels to 0 when clusters are outside of the specified range.

ParallelNeighborSearch — Parallel neighbor search to segment point cloud data

`false` (default) | `true`

Parallel neighbor search to segment point cloud data, specified as `true` or `false`. Set this property to `true` when you expect there to be approximately 50 clusters or more with fewer than 100 points per cluster.

A parallel neighbor search can improve segmentation speed for some datasets. Improved speed depends on the dataset and the value of the `minDistance` input.

Output Arguments

labels — Cluster labels

M-by-1 vector | *M*-by-*N* matrix

Cluster labels, returned as one of the following.

- If the point cloud, `ptCloud`, stores point locations as an unorganized *M*-by-3 matrix, then `labels` is an *M*-by-1 vector.
- If the point cloud, `ptCloud`, stores point locations as an organized *M*-by-*N*-by-3 array, then `labels` is an *M*-by-*N* matrix.

Each point in the point cloud has a cluster label, specified by the corresponding element in `labels`. The value of each label is an integer from 0 to the number of clusters of valid points, `numClusters`. The value 0 is reserved for invalid points, such as points with `Inf` or `NaN` coordinates.

numClusters — Number of clusters

positive integer

Number of clusters, returned as a positive integer. The number of clusters does not include the cluster corresponding to invalid points and excludes the label value, 0, which is reserved for invalid points.

Extended Capabilities

C/C++ Code Generation

Generate C and C++ code using MATLAB® Coder™.

GPU Code Generation

Generate CUDA® code for NVIDIA® GPUs using GPU Coder™.

Usage notes and limitations:

- The generated CUDA code segments the point cloud into clusters by using a combination of algorithms described in [1] and [2]. The output from the generated code can differ slightly with results from MATLAB simulation.
- The NumClusterPoints name-value argument is not supported for GPU code generation.

References

- [1] Andrade, Guilherme, Gabriel Ramos, Daniel Madeira, Rafael Sachetto, Renato Ferreira, and Leonardo Rocha. "G-DBSCAN: A GPU Accelerated Algorithm for Density-Based Clustering." *Procedia Computer Science* 18 (2013): 369–78. <https://doi.org/10.1016/j.procs.2013.05.200>.
- [2] Kalentev, Oleksandr, Abha Rai, Stefan Kemnitz, and Ralf Schneider. "Connected Component Labeling on a 2D Grid Using CUDA." *Journal of Parallel and Distributed Computing* 71, no. 4 (April 2011): 615–20. <https://doi.org/10.1016/j.jpdc.2010.10.012>.

See Also

pointCloud | pcdenoise | pcfitplane | pcshow | segmentLidarData

Introduced in R2018a

pcwrite

Write 3-D point cloud to PLY or PCD file

Syntax

```
pcwrite(ptCloud, filename)
pcwrite(ptCloud, filename, 'Encoding', encodingType)
```

Description

`pcwrite(ptCloud, filename)` writes the point cloud object, `ptCloud`, to the PLY or PCD file specified by the input filename.

`pcwrite(ptCloud, filename, 'Encoding', encodingType)` writes a `pointCloud` object, `ptCloud`, to a PLY file that is in the specified format.

Examples

Write 3-D Point Cloud to PLY File

```
ptCloud = pcread('teapot.ply');
pcshow(ptCloud);
```

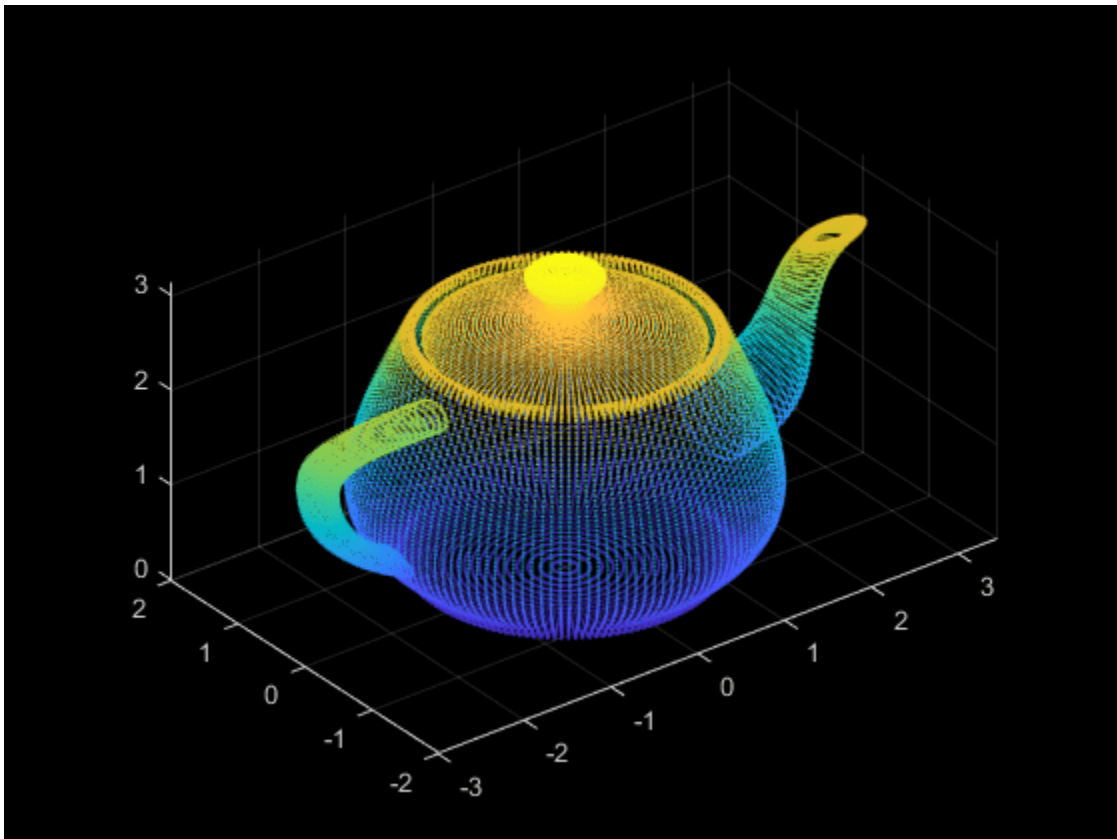

```
pcwrite(ptCloud, 'teapotOut', 'PLYFormat', 'binary');
```

Write 3-D Organized Point Cloud to PCD File

```
load('object3d.mat');  
pcwrite(ptCloud, 'object3d.pcd', 'Encoding', 'ascii');  
pc = pcread('object3d.pcd');  
pcshow(pc);
```

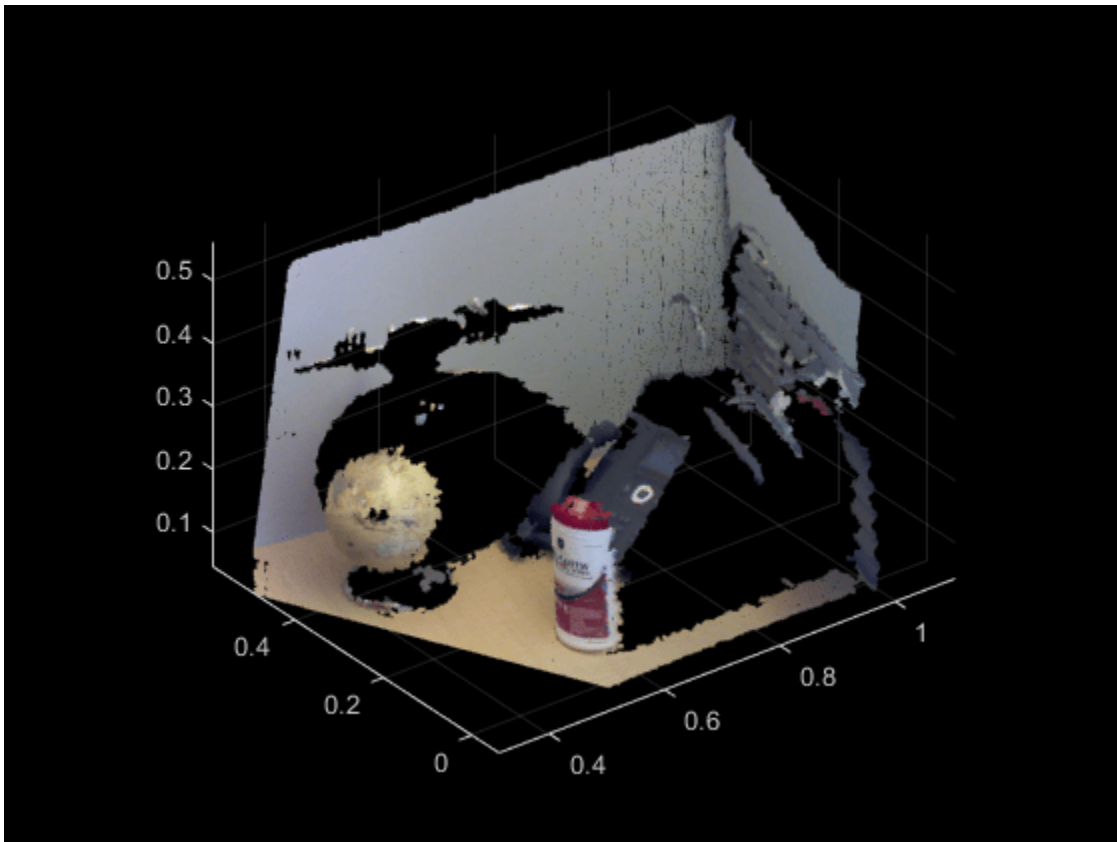

Input Arguments

filename – File name

character vector | string scalar

File name, specified as a character vector or string scalar. The input file type must be a PLY or PCD format file.

For a PLY-file, the `pcwrite` function converts an organized M -by- N -by-3 point cloud to an unorganized M -by-3 format. It converts the format because PLY files do not support organized point clouds. To preserve the organized format, you can save the point cloud as a PCD-file.

If you do not specify the file name with an extension, the function writes the file in a PLY-format.

ptCloud — Object for storing point cloud

pointCloud object

Object for storing point cloud, specified as a pointCloud object.

encodingType — PLY or PCD file

'ascii' (default) | 'binary' | 'compressed'

PLY or PCD formatted file, specified as the comma-separated pair consisting of 'Encoding', and either 'ascii', 'binary', 'compressed' for the file format.

File Format	Valid Encodings
PLY	'ascii', 'binary'
PCD	'ascii', 'binary', or 'compressed'

See Also

pointCloud | pcread | pcplayer | pcshow | pcmerge | pcfitsplane | planeModel | pctransform | pcdsample | pcdnoise | pcregistericp

Topics

“3-D Point Cloud Registration and Stitching”

Introduced in R2015a

pctransform

Transform 3-D point cloud

Syntax

```
ptCloudOut = pctransform(ptCloudIn,tform)
ptCloudOut = pctransform(ptCloudIn,D)
```

Description

`ptCloudOut = pctransform(ptCloudIn,tform)` applies the specified 3-D affine transform, `tform` to the point cloud, `ptCloudIn`. The transformation can be a rigid or nonrigid transform.

`ptCloudOut = pctransform(ptCloudIn,D)` applies the displacement field `D` to the point cloud. Point cloud transformation using a displacement field define translations with respect to each point in the point cloud.

Examples

Rotate 3-D Point Cloud Using Rigid Transformation

Read a point cloud.

```
ptCloud = pcread('teapot.ply');
```

Plot the point cloud.

```
figure
pcshow(ptCloud)
xlabel('X')
ylabel('Y')
zlabel('Z')
```

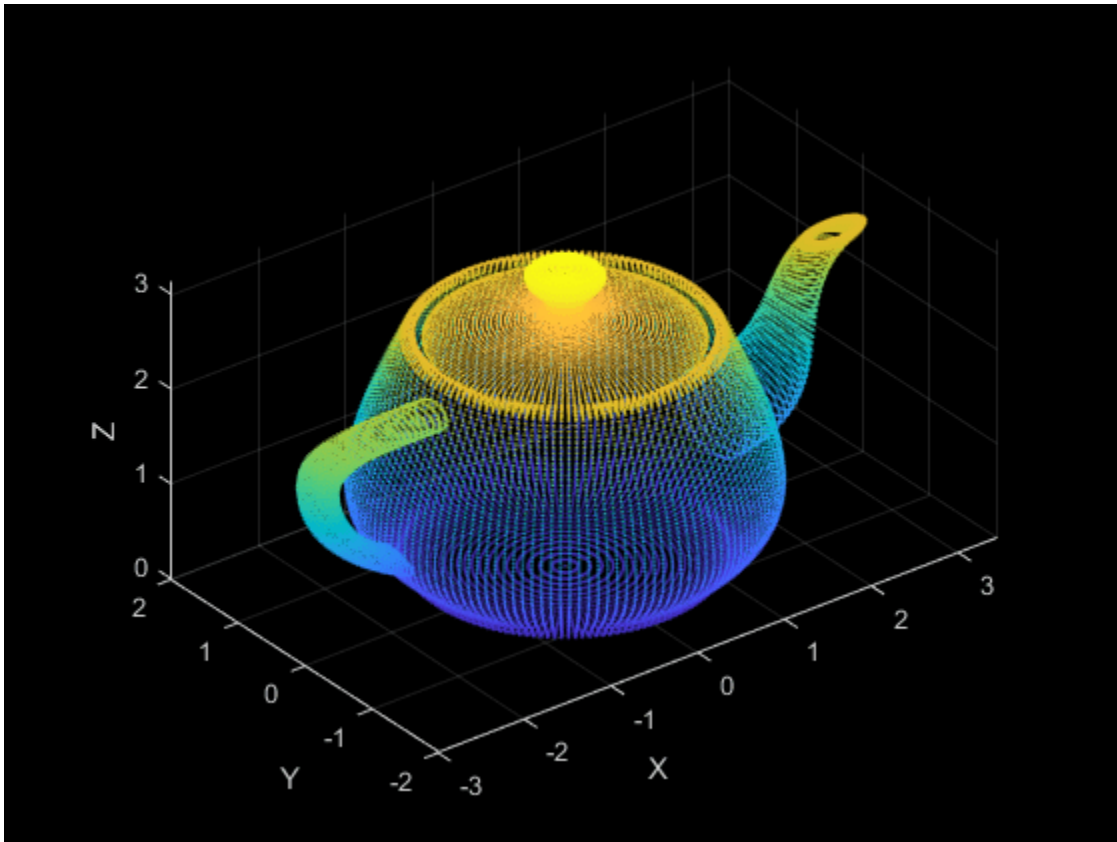
Create a transform object with a 45 degree rotation along the z-axis.

```
theta = pi/4;  
rot = [cos(theta) sin(theta) 0; ...  
      -sin(theta) cos(theta) 0; ...  
       0 0 1];  
trans = [0, 0, 0];  
tform = rigid3d(rot,trans);
```

Transform the point cloud.

```
ptCloudOut = pctransform(ptCloud,tform);
```

Plot the transformed point cloud.

```
figure  
pcshow(ptCloudOut)  
xlabel('X')  
ylabel('Y')  
zlabel('Z')
```

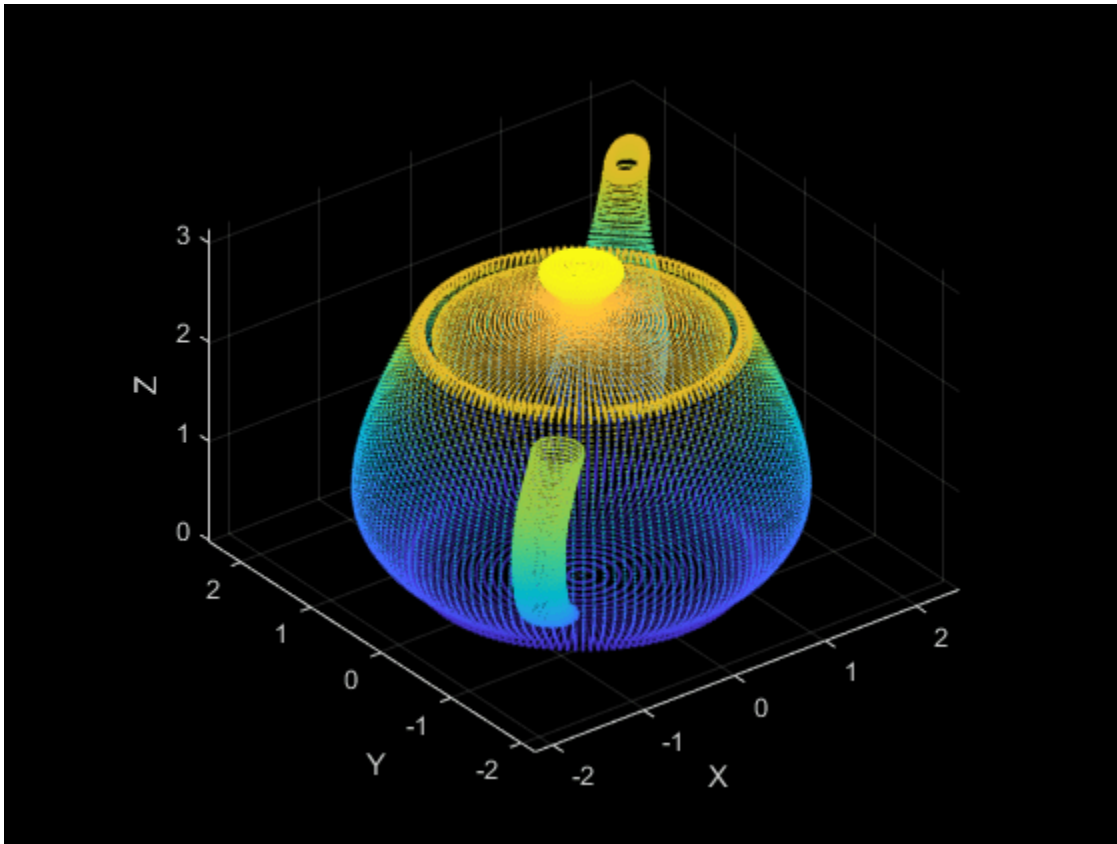

Affine Transformations of 3-D Point Cloud

This example shows affine transformation of a 3-D point cloud. The specified forward transform can be a rigid or nonrigid transform. The transformations shown includes rotation (rigid transform) and shearing (nonrigid transform) of the input point cloud.

Read a point cloud into the workspace.

```
ptCloud = pcread('teapot.ply');
```

Rotation of 3-D Point Cloud

Create an affine transform object that defines a 45 degree rotation along the z-axis.

```
A = [cos(pi/4) sin(pi/4) 0 0; ...  
     -sin(pi/4) cos(pi/4) 0 0; ...  
     0 0 1 0; ...  
     0 0 0 1];  
tform = affine3d(A);
```

Transform the point cloud.

```
ptCloudOut1 = pctransform(ptCloud,tform);
```

Shearing of 3-D point cloud

Create an affine transform object that defines shearing along the x-axis.

```
A = [1 0 0 0; ...
      0.75 1 0 0; ...
      0.75 0 1 0; ...
      0 0 0 1];
tform = affine3d(A);
```

Transform the point cloud.

```
ptCloudOut2 = pctransform(ptCloud,tform);
```

Display the Original and Affine Transformed 3-D Point Clouds

Plot the original 3-D point cloud.

```
figure1 = figure('WindowState','normal');
axes1 = axes('Parent',figure1);
pcshow(ptCloud, 'Parent',axes1);
xlabel('X');
ylabel('Y');
zlabel('Z');
title('3-D Point Cloud','FontSize',14)
```

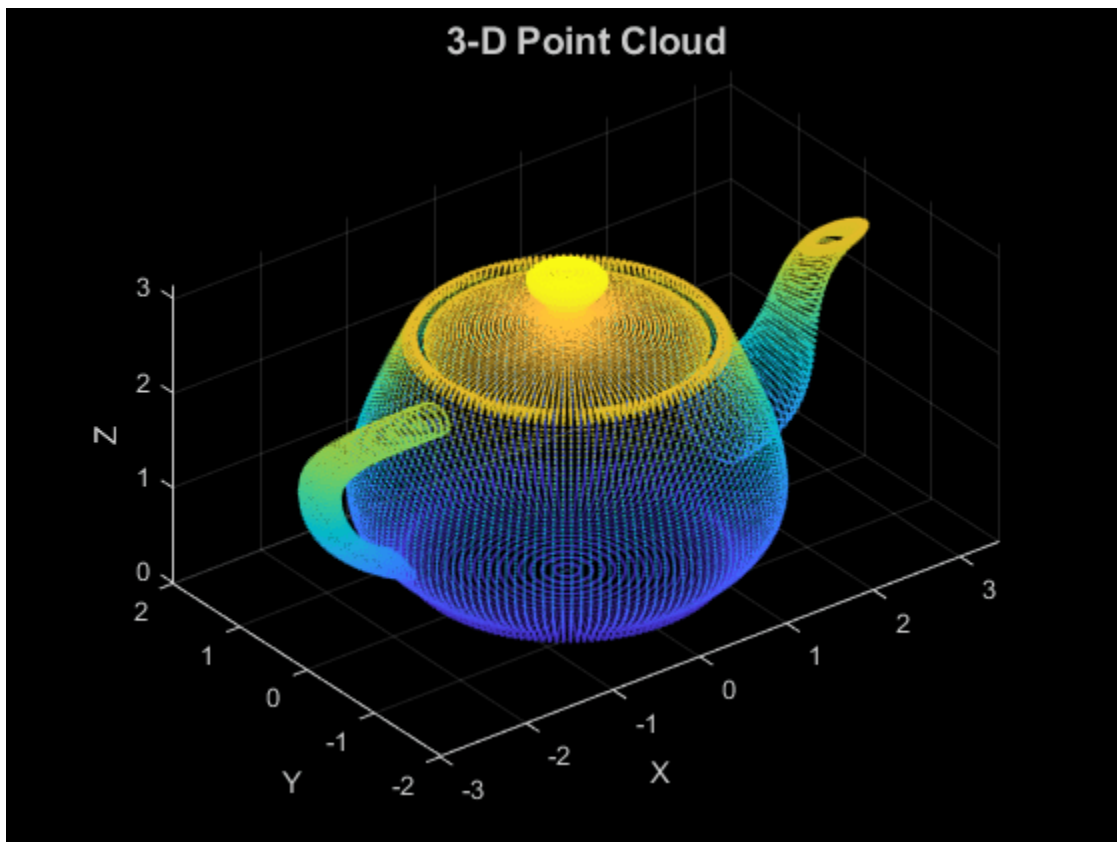

```
% Plot the rotation and shear affine transformed 3-D point clouds.
figure2 = figure('WindowState','normal');
```

```
axes2 = axes('Parent',figure2);
pcshow(ptCloudOut1,'Parent',axes2);
xlabel('X');
ylabel('Y');
zlabel('Z');
title({'Rotation of 3-D Point Cloud'},'FontSize',14)
```

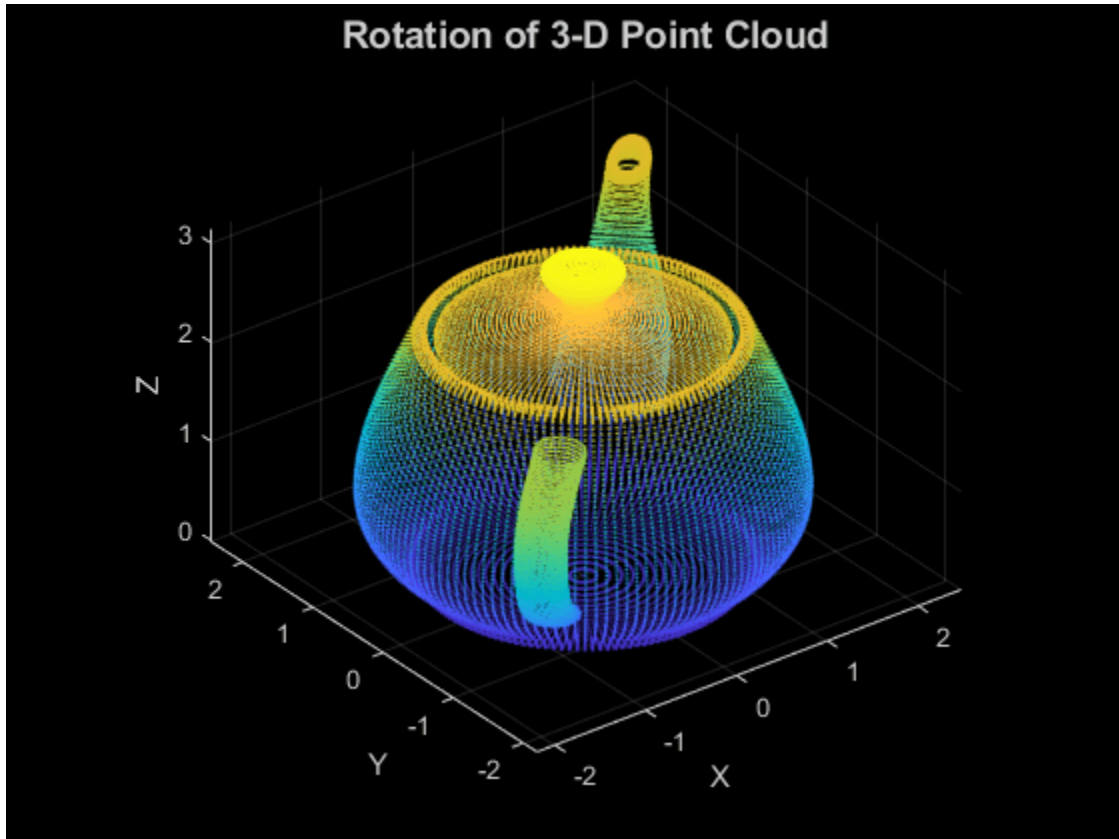

```
figure3 = figure('WindowState','normal');
axes3 = axes('Parent',figure3);
pcshow(ptCloudOut2,'Parent',axes3);
xlabel('X');
ylabel('Y');
zlabel('Z');
title({'Shearing of 3-D Point Cloud'},'FontSize',14)
```

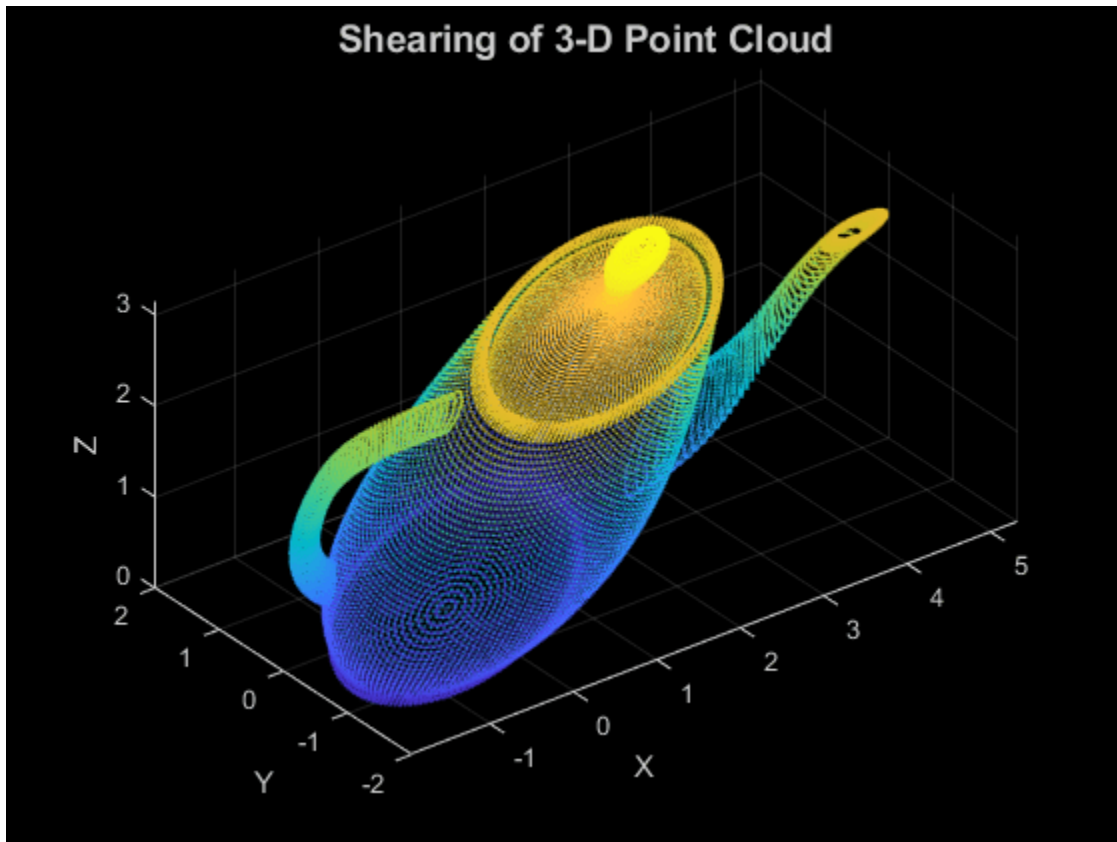

Point Cloud Transformation Using Displacement Field

Read a point cloud into the workspace.

```
ptCloud = pcread('teapot.ply');
```

Create a displacement field D of same size as the point cloud.

```
D = zeros(size(ptCloud.Location));
```

Set the displacement field value along x-axis for the first half of the points to 7.

```
pthalf = ptCloud.Count/2;
D(1:pthalf,1) = 7;
```

Extract the indices of points within a region-of-interest (ROI) using the `pointCloud` method `findNeighborsInRadius`. Set the displacement field value along the x-, y-, and z-axis for points within the ROI to 4, 4, and -2, respectively.

```
indices = findNeighborsInRadius(ptCloud,[0 0 3.1],1.5);
D(indices,1:2) = 4;
D(indices,3) = -2;
```

Transform the point cloud using the displacement field.

```
ptCloudOut = pctransform(ptCloud,D);
```

Display the original and transformed point cloud.

```
figure
pcshow(ptCloud)
xlabel('X');
ylabel('Y');
zlabel('Z');
title('Original 3-D Point Cloud')
```

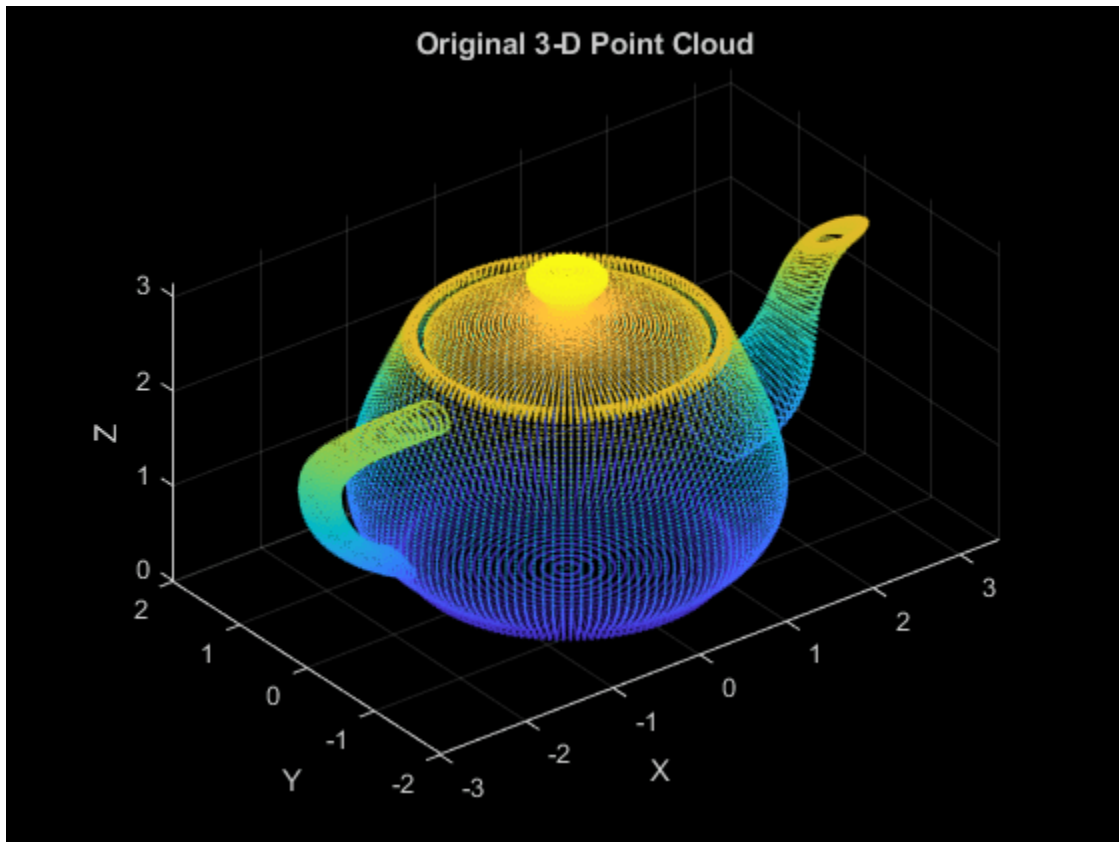

```
figure
pcshow(ptCloudOut)
xlabel('X');
ylabel('Y');
zlabel('Z');
title('Transformed 3-D Point Cloud Using Displacement Field')
```

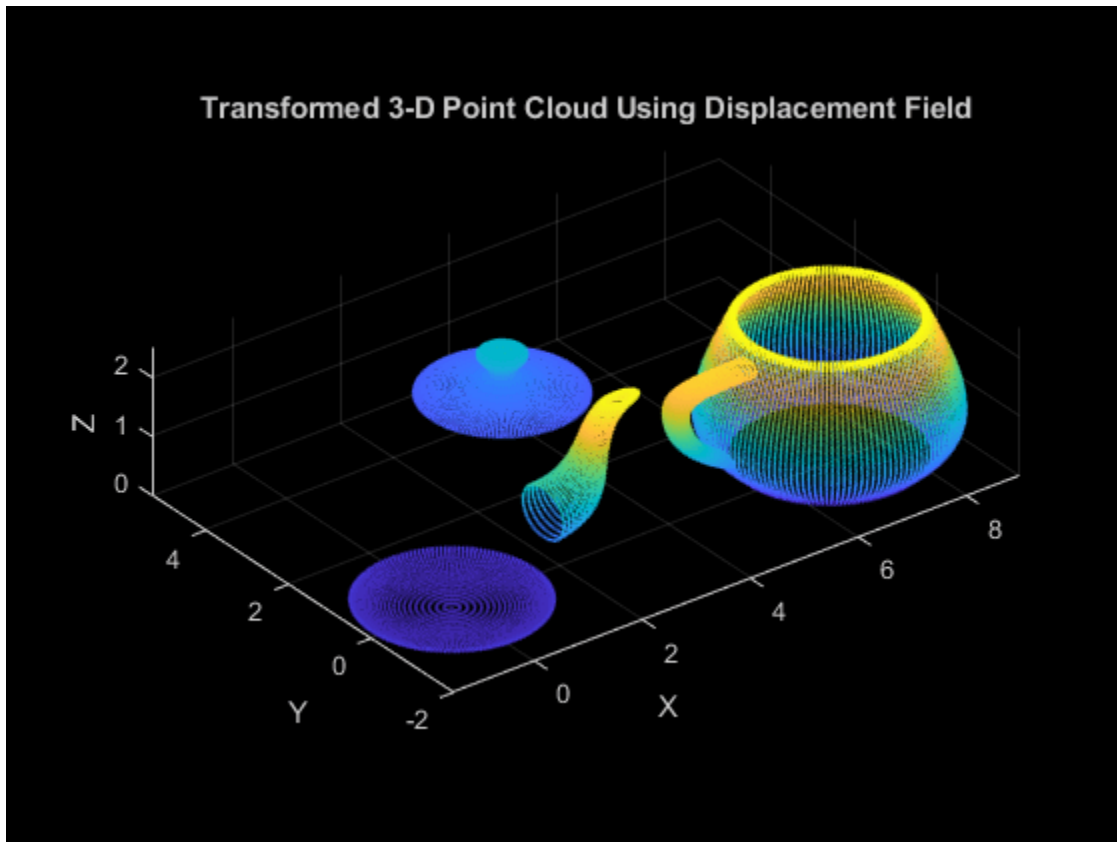

Input Arguments

ptCloudIn — Point cloud

`pointCloud` object

Point cloud, specified as a `pointCloud` object.

tform — 3-D geometric transformation

`rigid3d` object | `affine3d` object

3-D geometric transformation, specified as a `rigid3d` object or an `affine3d` object. See “Define Transformation Matrix” for details on how to set up an affine 3-D `tform` input.

D — Displacement field

M -by-3 matrix | M -by- N -by-3 array

Displacement field, specified as either M -by-3 or an M -by- N -by-3 array. The displacement field is a set of displacement vectors that specify the magnitude and direction of translation for each point in the point cloud. The size of the displacement field must be the same as the size of the `Location` property of the `pointCloud` object.

Data Types: `single` | `double`

Output Arguments

ptCloudOut — Transformed point cloud

`pointCloud` object

Transformed point cloud, returned as a `pointCloud` object. The transformation applies to the coordinates of points and their normal vectors.

Extended Capabilities

C/C++ Code Generation

Generate C and C++ code using MATLAB® Coder™.

GPU Code Generation

Generate CUDA® code for NVIDIA® GPUs using GPU Coder™.

See Also

Objects

`pointCloud` | `planeModel` | `affine3d` | `rigid3d`

Functions

`pcplayer` | `pcshow` | `pcwrite` | `pcread` | `pcmerge` | `pcdownsample` | `pcfitplane` | `pcdenoise` | `pcregistericp` | `pccat` | `pcalign`

Topics

“3-D Point Cloud Registration and Stitching”

Introduced in R2015a

pcnormals

Estimate normals for point cloud

Syntax

```
normals = pcnormals(ptCloud)
normals = pcnormals(ptCloud,k)
```

Description

`normals = pcnormals(ptCloud)` returns a matrix that stores a normal for each point in the input `ptCloud`. The function uses six neighboring points to fit a local plane to determine each normal vector.

`normals = pcnormals(ptCloud,k)` additionally specifies `k`, the number of points used for local plane fitting. The function uses this value rather than the six neighboring points as described in the first syntax.

Examples

Estimate Normals of Point Cloud

Load a point cloud.

```
load('object3d.mat');
```

Estimate the normal vectors.

```
normals = pcnormals(ptCloud);
```

```
figure
pcshow(ptCloud)
title('Estimated Normals of Point Cloud')
hold on
```

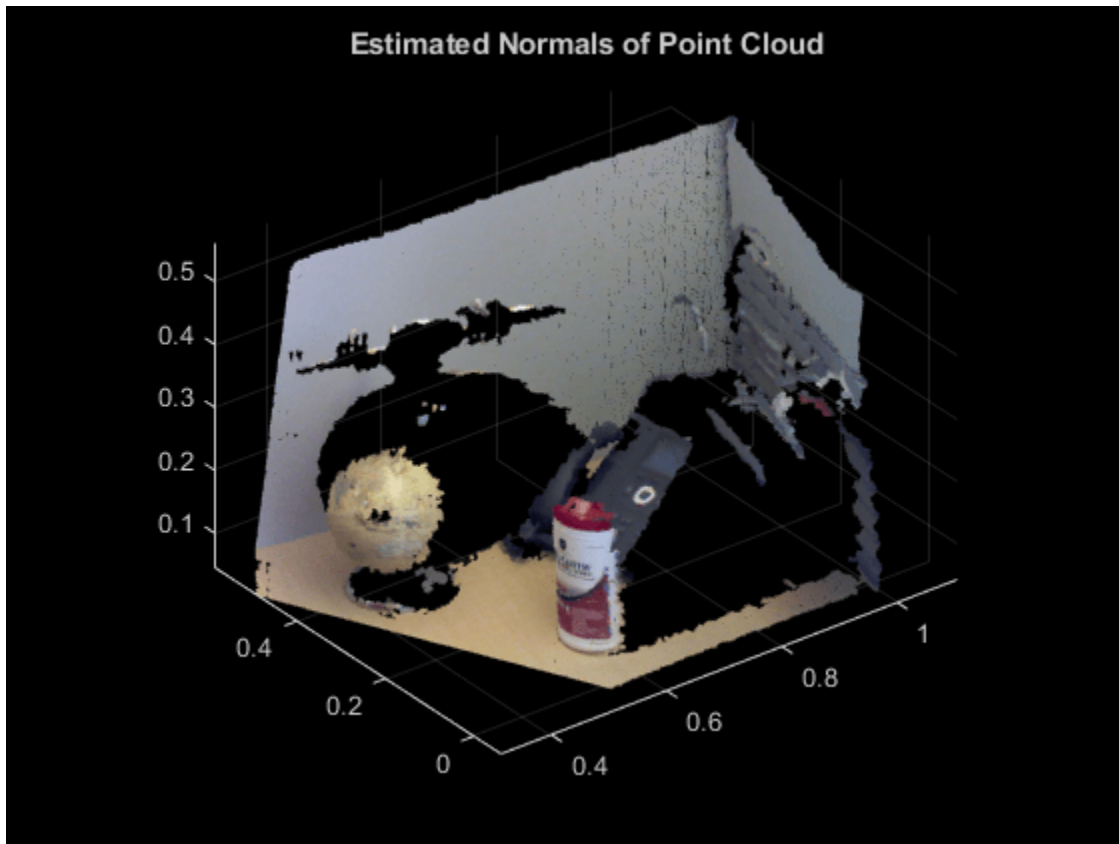

```
x = ptCloud.Location(1:10:end,1:10:end,1);  
y = ptCloud.Location(1:10:end,1:10:end,2);  
z = ptCloud.Location(1:10:end,1:10:end,3);  
u = normals(1:10:end,1:10:end,1);  
v = normals(1:10:end,1:10:end,2);  
w = normals(1:10:end,1:10:end,3);
```

Plot the normal vectors.

```
quiver3(x,y,z,u,v,w);  
hold off
```

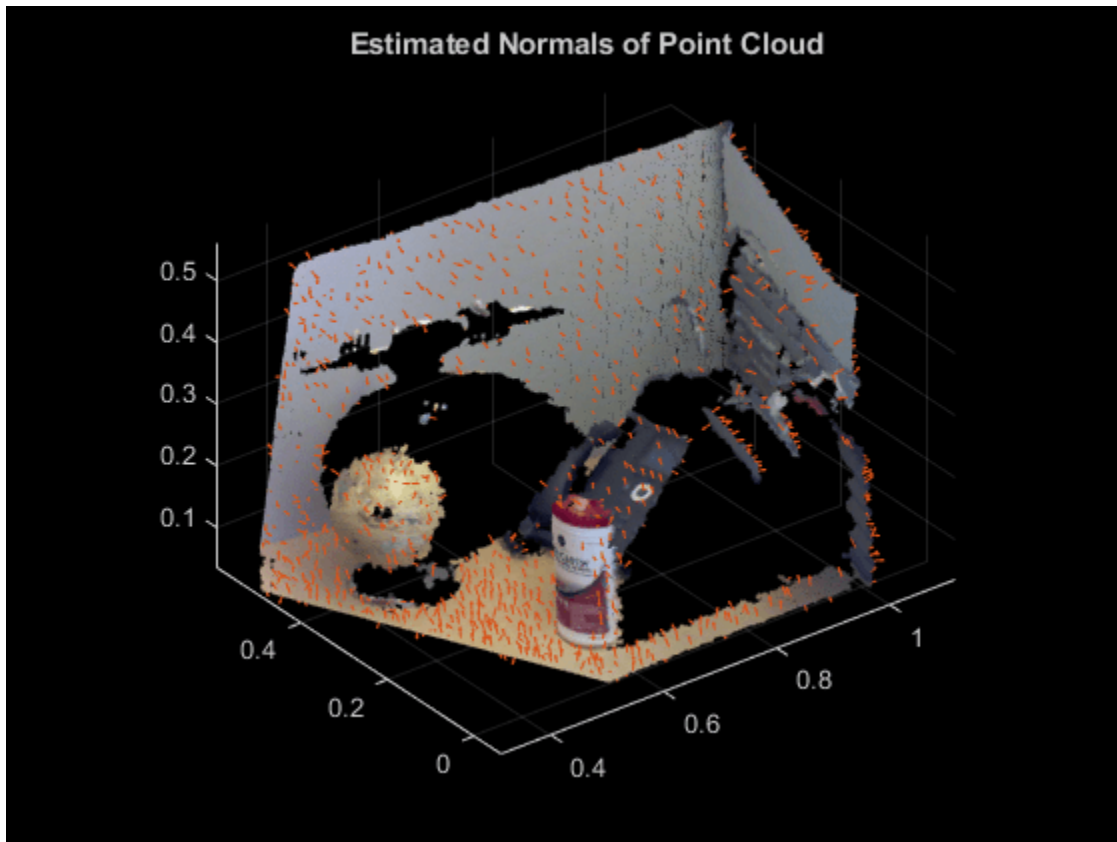

Flip the normals to point towards the sensor location. This step is necessary only for determining the inward or outward direction of the surface. The sensor center is set in x, y, z coordinates.

```

sensorCenter = [0, -0.3, 0.3];
for k = 1 : numel(x)
    p1 = sensorCenter - [x(k), y(k), z(k)];
    p2 = [u(k), v(k), w(k)];
    % Flip the normal vector if it is not pointing towards the sensor.
    angle = atan2(norm(cross(p1, p2)), p1*p2');
    if angle > pi/2 || angle < -pi/2
        u(k) = -u(k);
        v(k) = -v(k);
        w(k) = -w(k);
    end
end
end

```

Plot the adjusted normals.

```

figure
pcshow(ptCloud)
title('Adjusted Normals of Point Cloud')
hold on
quiver3(x, y, z, u, v, w);
hold off

```

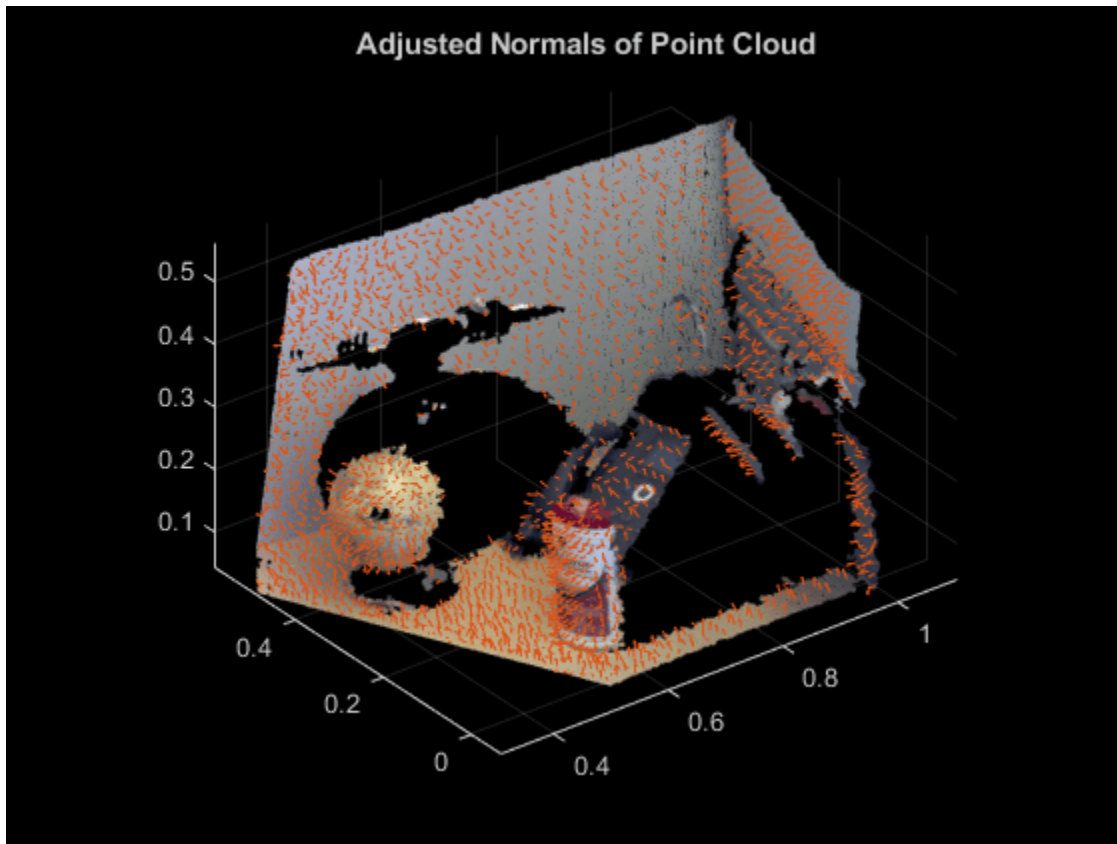

Input Arguments

ptCloud — Object for storing point cloud

`pointCloud` object

Object for storing point cloud, returned as a `pointCloud` object.

k — Number of points used for local plane fitting

integer greater than or equal to 3

Number of points used for local plane fitting, specified as an integer greater than or equal to 3. Increasing this value improves accuracy but slows down computation time. If you do not specify `k`, the function uses six neighboring points to fit a local plane to determine each normal vector.

Output Arguments

normals — Normals used to fit a local plane

M -by-3 | M -by- N -by-3

Normals used to fit a local plane, returned as an M -by-3 or an M -by- N -by-3 vector. The normal vectors are computed locally using six neighboring points. The direction of each normal vector can be set based on how you acquired the points. The “Estimate Normals of Point Cloud” on page 3-755 example, shows how to set the direction when the normal vectors are pointing towards the sensor.

References

[1] Hoppe, H., T. DeRose, T. Duchamp, J. McDonald, and W. Stuetzle. "Surface Reconstruction from Unorganized Points". *Computer Graphics (SIGGRAPH 1992 Proceedings)*. 1992, pp. 71-78.

Extended Capabilities

C/C++ Code Generation

Generate C and C++ code using MATLAB® Coder™.

GPU Code Generation

Generate CUDA® code for NVIDIA® GPUs using GPU Coder™.

Usage notes and limitations:

- For GPU code generation, the number of neighbors must be a compile-time constant.
- Because of architectural and implementation differences between the GPU and CPU, the choice of neighboring points may differ during computation of normal vectors. As a result, there may be numerical mismatch between MATLAB simulation and the output from code generation.

See Also

[pointCloud](#) | [pcplayer](#) | [pcshow](#) | [pcwrite](#) | [pcmerge](#) | [pcfitplane](#) | [planeModel](#) | [pctransform](#) | [pcdownsample](#) | [pcdenoise](#) | [pcregistericp](#)

Topics

["3-D Point Cloud Registration and Stitching"](#)

["The PLY Format"](#)

Introduced in R2015b

pcfitcylinder

Fit cylinder to 3-D point cloud

Syntax

```
model = pcfitcylinder(ptCloudIn,maxDistance)
model = pcfitcylinder(ptCloudIn,maxDistance,referenceVector)
model = pcfitcylinder(ptCloudIn,maxDistance,referenceVector,
maxAngularDistance)
```

```
[model,inlierIndices,outlierIndices] = pcfitcylinder(ptCloudIn,maxDistance)
[ ___,meanError] = pcfitcylinder(ptCloudIn,maxDistance)
[ ___ ] = pcfitcylinder( ___,Name,Value)
```

Description

`model = pcfitcylinder(ptCloudIn,maxDistance)` fits a cylinder to a point cloud with a maximum allowable distance from an inlier point to the cylinder. This function uses the M-estimator Sample Consensus (MSAC) algorithm to find the cylinder.

`model = pcfitcylinder(ptCloudIn,maxDistance,referenceVector)` fits a cylinder to the point cloud with additional orientation constraints specified by the 1-by-3 reference orientation input vector.

`model = pcfitcylinder(ptCloudIn,maxDistance,referenceVector,maxAngularDistance)` additionally specifies the maximum allowed absolute angular distance.

`[model,inlierIndices,outlierIndices] = pcfitcylinder(ptCloudIn,maxDistance)` additionally returns linear indices to the inlier and outlier points in the point cloud input.

`[___,meanError] = pcfitcylinder(ptCloudIn,maxDistance)` additionally returns the mean error of the distance of the inlier points to the model.

`[___] = pcfitcylinder(___,Name,Value)` uses additional options specified by one or more Name,Value pair arguments.

Examples

Extract Cylinder from Point Cloud

Load the point cloud.

```
load('object3d.mat');
```

Display the point cloud.

```
figure
pcshow(ptCloud)
xlabel('X(m)')
ylabel('Y(m)')
```

```
zlabel('Z(m)')
title('Original Point Cloud')
```

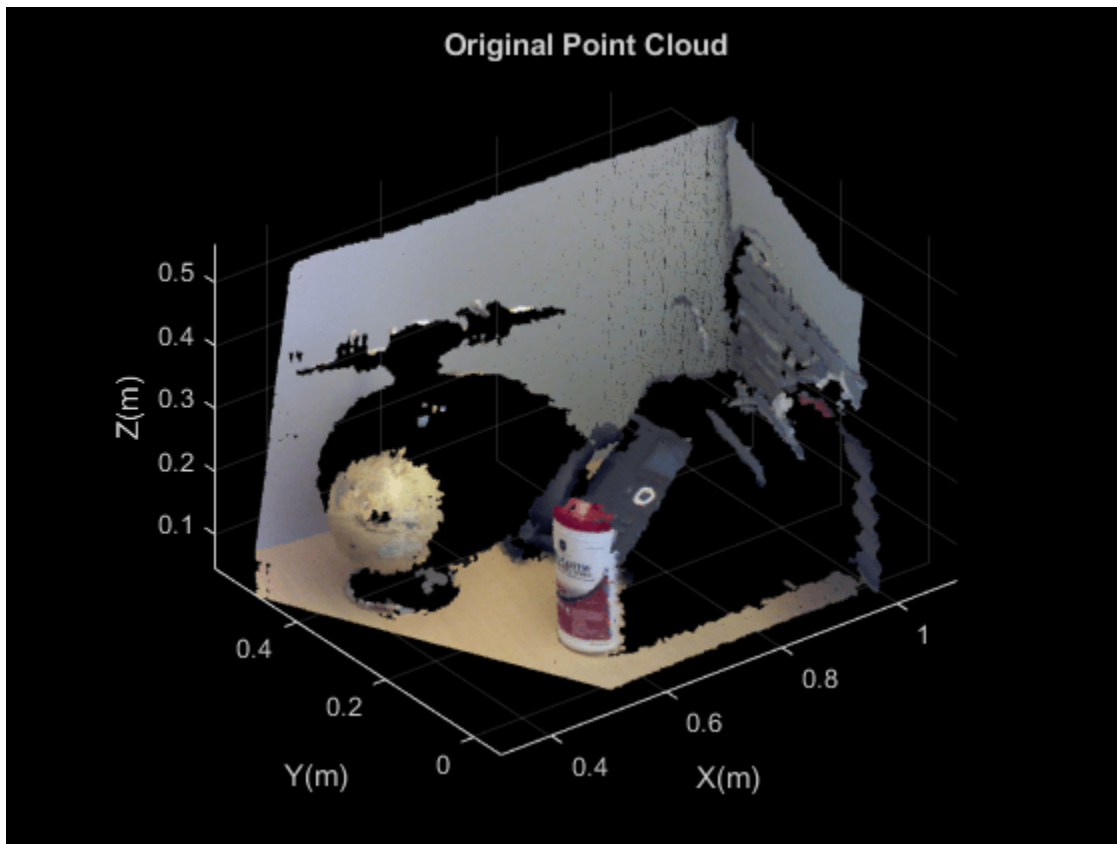

Set the maximum point-to-cylinder distance (5 mm) for cylinder fitting.

```
maxDistance = 0.005;
```

Set the region of interest to constrain the search.

```
roi = [0.4,0.6, -inf,0.2,0.1,inf];
sampleIndices = findPointsInROI(ptCloud,roi);
```

Set the orientation constraint.

```
referenceVector = [0,0,1];
```

Detect the cylinder and extract it from the point cloud by specifying the inlier points.

```
[model,inlierIndices] = pcfitcylinder(ptCloud,maxDistance,...
    referenceVector,'SampleIndices',sampleIndices);
pc = select(ptCloud,inlierIndices);
```

Plot the extracted cylinder.

```
figure
pcshow(pc)
title('Cylinder Point Cloud')
```

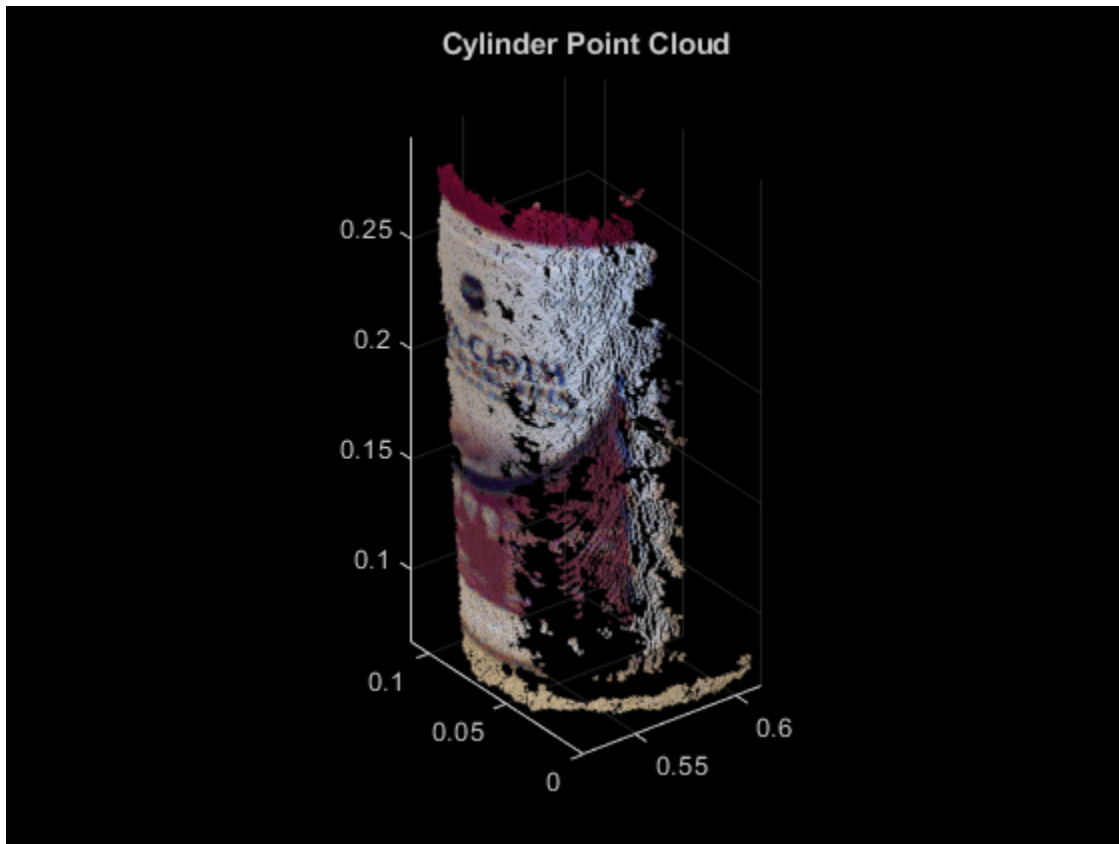

Detect Cylinder in Point Cloud

Load the point cloud.

```
load('object3d.mat');
```

Display point cloud.

```
figure  
pcshow(ptCloud)  
xlabel('X(m)')  
ylabel('Y(m)')  
zlabel('Z(m)')  
title('Detect a Cylinder in a Point Cloud')
```

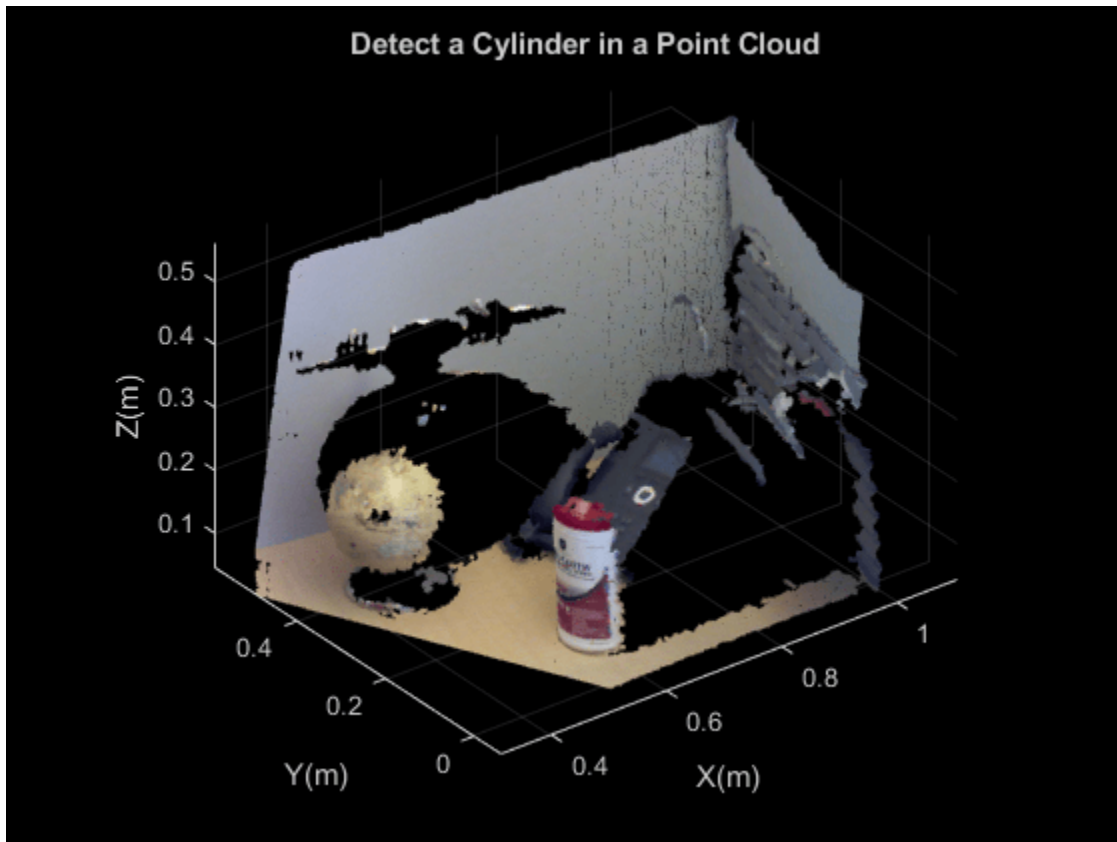
Set the maximum point-to-cylinder distance (5 mm) for the cylinder fitting.

```
maxDistance = 0.005;
```

Set the region of interest to constrain the search.

```
roi = [0.4,0.6;-inf,0.2;0.1,inf];
sampleIndices = findPointsInROI(ptCloud,roi);
```

Set the orientation constraint.

```
referenceVector = [0,0,1];
```

Detect the cylinder in the point cloud and extract it.

```
model = pcfitcylinder(ptCloud,maxDistance,referenceVector,...
    'SampleIndices',sampleIndices);
```

Plot the cylinder.

```
hold on
plot(model)
```

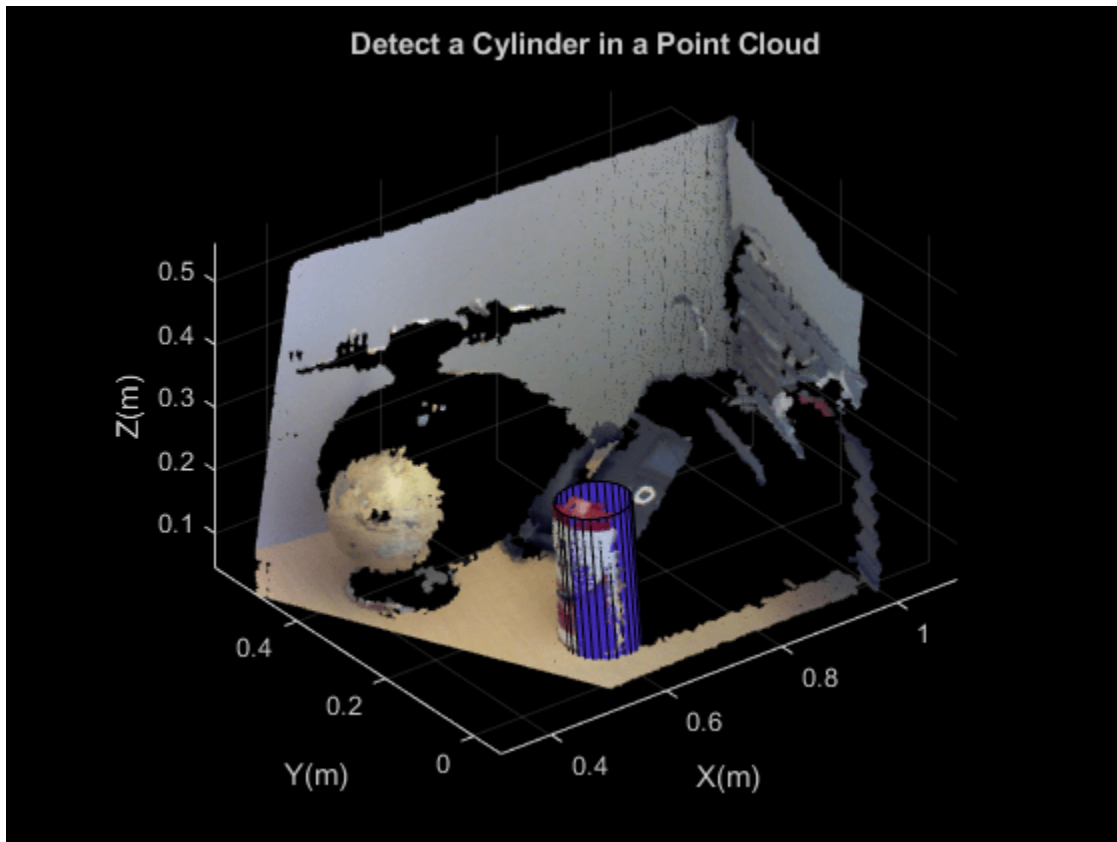

Input Arguments

ptCloudIn — Point cloud

pointCloud object

Point cloud, specified as a `pointCloud` object. If the `Normal` property of the input `ptCloud` is empty, the function populates it with values to meet the requirements of the fitting algorithm.

maxDistance — Maximum distance from an inlier point to the cylinder

scalar value

Maximum distance from an inlier point to the cylinder, specified as a scalar value. Specify the distance in units that are consistent with the units you are using for the point cloud.

Data Types: `single` | `double`

referenceVector — Reference orientation

1-by-3 vector

Reference orientation, specified as a 1-by-3 vector.

maxAngularDistance — Maximum absolute angular distance

5 (default) | scalar value

Maximum absolute angular distance, specified as a scalar value. The maximum angular distance is measured in degrees between the direction of the fitted cylinder and the reference orientation.

Name-Value Pair Arguments

Specify optional comma-separated pairs of `Name`, `Value` arguments. `Name` is the argument name and `Value` is the corresponding value. `Name` must appear inside quotes. You can specify several name and value pair arguments in any order as `Name1,Value1,...,NameN,ValueN`.

Example: `'SampleIndices',[]`.

SampleIndices — Linear indices of points to sample

`[]` (default) | column vector

Linear indices of points to sample in the input point cloud, specified as the comma-separated pair consisting of `'SampleIndices'` and a column vector. An empty vector means that all points are candidates to sample when fitting the cylinder during the RANSAC iteration. If you specify a subset of points, the function fits the model by sampling only those points in the subset. Providing a subset of points can significantly speed up the process by reducing the number of trials. You can generate the indices vector using the `findPointsInROI` method of the `pointCloud` object.

MaxNumTrials — Maximum number of random trials

1000 (default) | positive integer

Maximum number of random trials for finding inliers, specified as the comma-separated pair consisting of `'MaxNumTrials'` and a positive integer. To improve robustness of the output, increase this value. However, doing so adds additional computations.

Confidence — Percentage for finding maximum number of inliers

99 (default) | numeric scalar in the range (0,100)

Percentage for finding maximum number of inliers, specified as the comma-separated pair consisting of `'Confidence'` and a numeric scalar, in the range (0 100). To improve the robustness of the output, increase this value. However, doing so adds additional computations.

Output Arguments

model — Geometric model of cylinder

`cylinderModel` object.

Geometric model of cylinder, returned as a `cylinderModel` object.

The coefficients for the output model are set to zero when:

- The input point cloud does not contain enough valid points.
- The algorithm cannot find enough inlier points.

inlierIndices — Linear indices of inlier points

column vector

Linear indices of the inlier points in the input point cloud, returned as a column vector.

outlierIndices — Linear indices of outlier points

column vector

Linear indices of the outlier points in the input point cloud returned as a column vector.

meanError — Mean square error

scalar value

Mean error of the distance of inlier points to the model, returned as a scalar value.

Algorithms

The function returns a geometric model that describes the cylinder. This function uses the M-estimator Sample Consensus (MSAC) algorithm to find the cylinder. The MSAC algorithm is a variant of the RANdom SAMple Consensus (RANSAC) algorithm.

The fitting algorithm for the `pcfitcylinder` function requires point cloud normals. Therefore, if the `Normal` property for the input point cloud is empty, the function fills it. When the function fills the `Normal` property, it uses six points to fit the local cylinder. If six points do not work and the fitting fails, consider calling the `pcnormals` function which enables you to select the number of points to use.

References

- [1] Torr, P. H. S., and A. Zisserman. "MLE-SAC: A New Robust Estimator with Application to Estimating Image Geometry." *Computer Vision and Image Understanding*. Volume 78, Issue 1, April 2000, pp. 138-156.

Extended Capabilities**C/C++ Code Generation**

Generate C and C++ code using MATLAB® Coder™.

See Also

`pcfitplane` | `pcfitsphere` | `pointCloud` | `pcplayer` | `pcshow` | `pcwrite` | `pcread` | `cylinderModel` | `planeModel` | `pcmerge` | `pctransform` | `pcregistericp` | `pcdenoise` | `affine3d`

Topics

"3-D Point Cloud Registration and Stitching"

Introduced in R2015b

pcfitplane

Fit plane to 3-D point cloud

Syntax

```
model = pcfitplane(ptCloudIn,maxDistance)
model = pcfitplane(ptCloudIn,maxDistance,referenceVector)
model = pcfitplane(ptCloudIn,maxDistance,referenceVector,maxAngularDistance)

[model,inlierIndices,outlierIndices] = pcfitplane(ptCloudIn,maxDistance)
[ ___,meanError] = pcfitplane(ptCloudIn,maxDistance)
[ ___ ] = pcfitplane(ptCloudIn,maxDistance,Name,Value)
```

Description

`model = pcfitplane(ptCloudIn,maxDistance)` fits a plane to a point cloud that has a maximum allowable distance from an inlier point to the plane. The function returns a geometrical model that describes the plane.

This function uses the M-estimator SAMple Consensus (MSAC) algorithm to find the plane. The MSAC algorithm is a variant of the RANdom SAMple Consensus (RANSAC) algorithm.

`model = pcfitplane(ptCloudIn,maxDistance,referenceVector)` fits a plane to a point cloud that has additional orientation constraints specified by the 1-by-3 `referenceVector` input.

`model = pcfitplane(ptCloudIn,maxDistance,referenceVector,maxAngularDistance)` fits a plane to a point cloud that has a specified maximum angular distance.

`[model,inlierIndices,outlierIndices] = pcfitplane(ptCloudIn,maxDistance)` additionally returns the linear indices to the inlier and outlier points in the point cloud input.

`[___,meanError] = pcfitplane(ptCloudIn,maxDistance)` additionally returns the mean error of the distance of inlier points to the model, using any of the preceding syntaxes.

`[___] = pcfitplane(ptCloudIn,maxDistance,Name,Value)` uses additional options specified by one or more `Name,Value` pair arguments.

Examples

Detect Multiple Planes from Point Cloud

Load the point cloud.

```
load('object3d.mat')
```

Display and label the point cloud.

```
figure
pcshow(ptCloud)
xlabel('X(m)')
```

```

ylabel('Y(m)')
xlabel('X(m)')
title('Original Point Cloud')

```

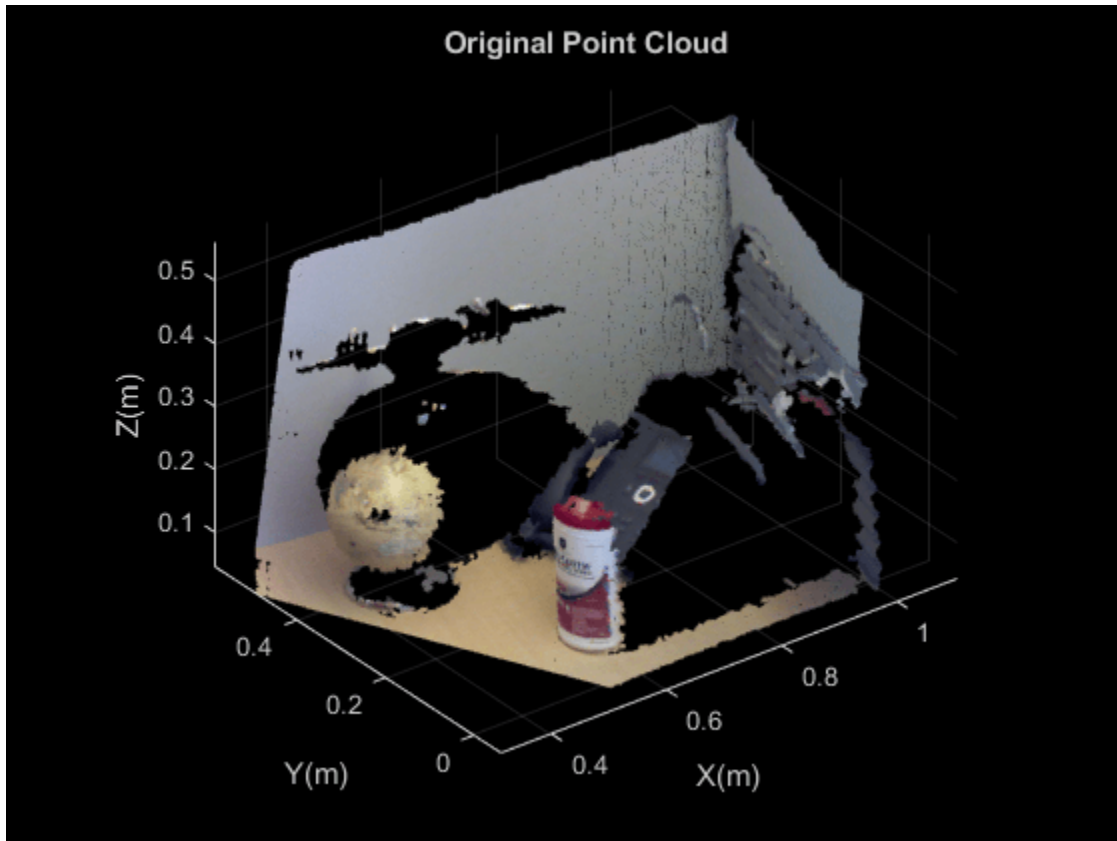

Set the maximum point-to-plane distance (2cm) for plane fitting.

```
maxDistance = 0.02;
```

Set the normal vector of the plane.

```
referenceVector = [0,0,1];
```

Set the maximum angular distance to 5 degrees.

```
maxAngularDistance = 5;
```

Detect the first plane, the table, and extract it from the point cloud.

```

[model1,inlierIndices,outlierIndices] = pcfplane(ptCloud,...
    maxDistance,referenceVector,maxAngularDistance);
plane1 = select(ptCloud,inlierIndices);
remainPtCloud = select(ptCloud,outlierIndices);

```

Set the region of interest to constrain the search for the second plane, left wall.

```

roi = [-inf,inf;0.4,inf;-inf,inf];
sampleIndices = findPointsInROI(remainPtCloud,roi);

```

Detect the left wall and extract it from the remaining point cloud.

```
[model2,inlierIndices,outlierIndices] = pcfitplane(remainPtCloud,...  
          maxDistance,'SampleIndices',sampleIndices);  
plane2 = select(remainPtCloud,inlierIndices);  
remainPtCloud = select(remainPtCloud,outlierIndices);
```

Plot the two planes and the remaining points.

```
figure  
pcshow(plane1)  
title('First Plane')
```

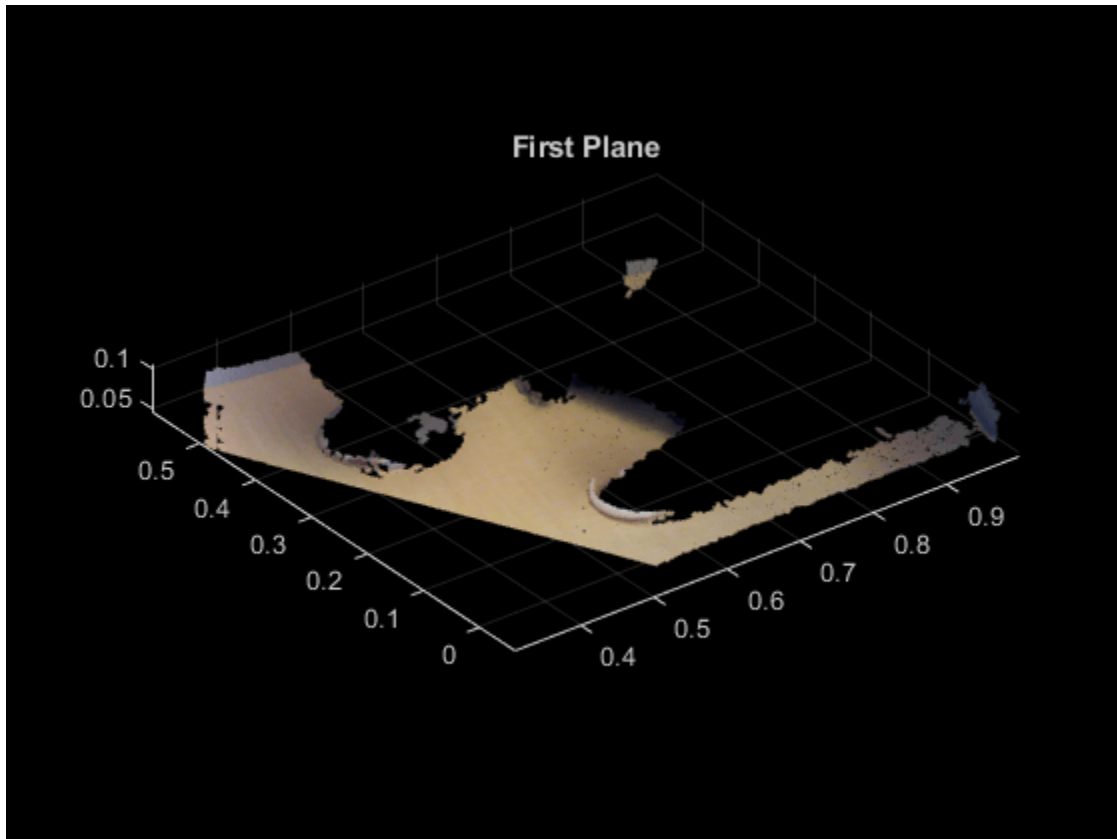

```
figure  
pcshow(plane2)  
title('Second Plane')
```

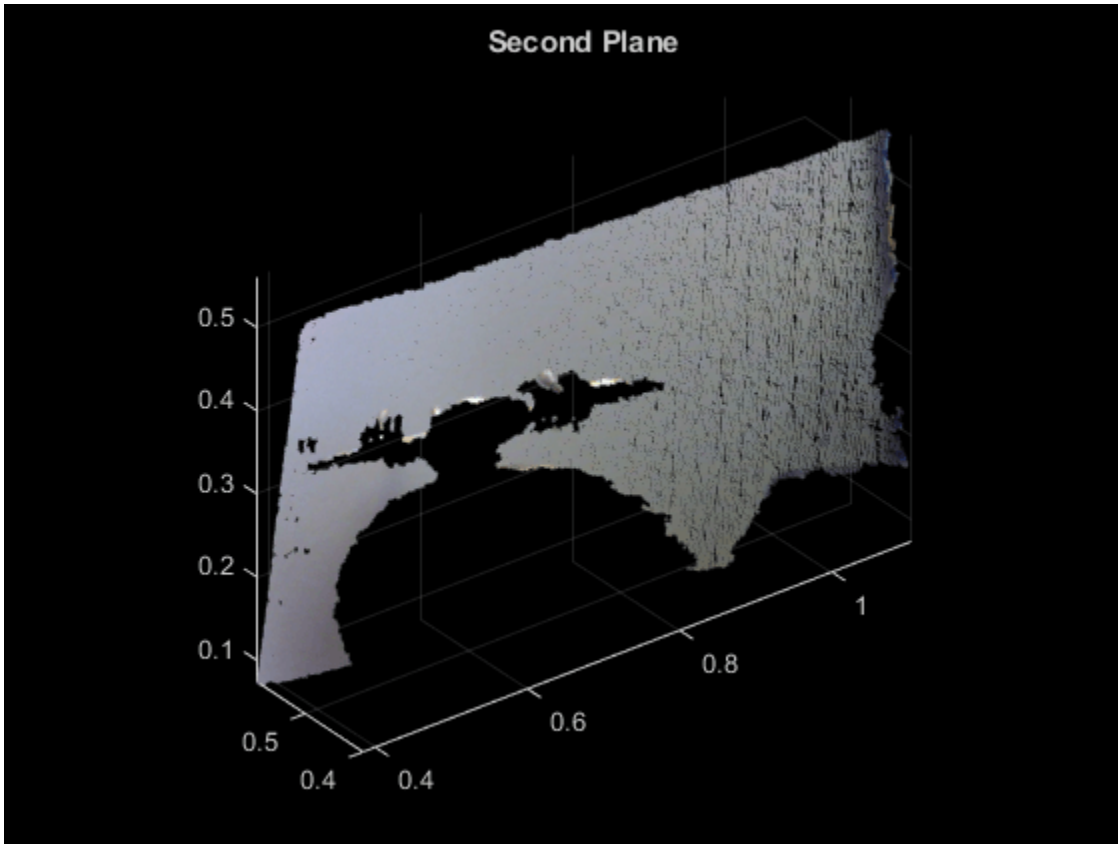

```
figure  
pcshow(remainPtCloud)  
title('Remaining Point Cloud')
```

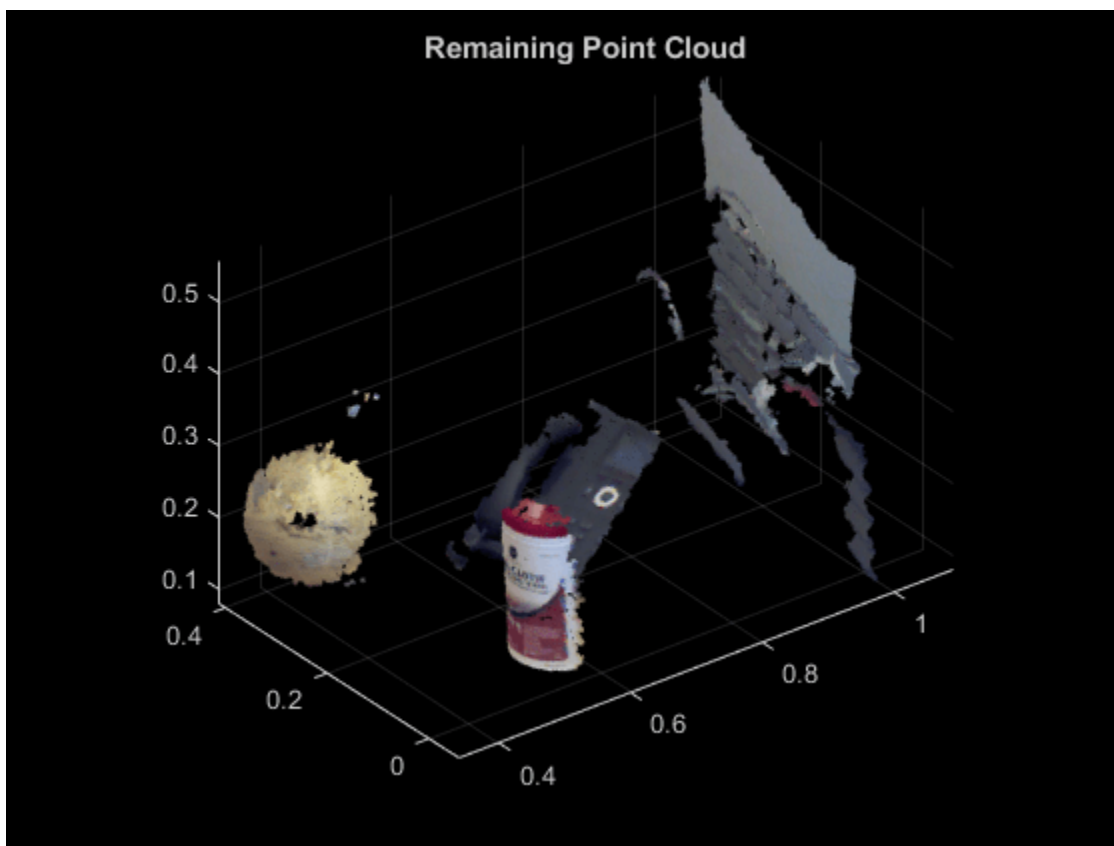
Input Arguments

ptCloudIn — Point cloud

pointCloud object

Point cloud, specified as a pointCloud object.

maxDistance — Maximum distance from an inlier point to the plane

scalar value

Maximum distance from an inlier point to the plane, specified as a scalar value. Specify the distance in units that are consistent with the units you are using for the point cloud.

Data Types: single | double

referenceVector — Reference orientation constraint

1-by-3 vector

Reference orientation constraint, specified as a 1-by-3 vector.

Data Types: single | double

maxAngularDistance — Maximum absolute angular distance

5 degrees (default) | scalar value

Maximum absolute angular distance between the normal vector of the fitted plane and the reference orientation, specified as a scalar value in degrees.

Data Types: `single` | `double`

Name-Value Pair Arguments

Specify optional comma-separated pairs of `Name`, `Value` arguments. `Name` is the argument name and `Value` is the corresponding value. `Name` must appear inside quotes. You can specify several name and value pair arguments in any order as `Name1, Value1, . . . , NameN, ValueN`.

Example: `'SampleIndices', []`.

SampleIndices — Linear indices of points to be sampled

`[]` (default) | column vector

Linear indices of points to sample in the input point cloud, specified as the comma-separated pair consisting of `'SampleIndices'` and a column vector. An empty vector means that all points are candidates to sample in the RANSAC iteration to fit the plane. When you specify a subset, only points in the subset are sampled to fit a model.

Providing a subset of points can significantly speed up the process and reduce the number of trials. You can generate the indices vector using the `findPointsInROI` method of the `pointCloud` object.

MaxNumTrials — Maximum number of random trials

`1000` (default) | positive integer

Maximum number of random trials for finding inliers, specified as the comma-separated pair consisting of `'MaxNumTrials'` and a positive integer. Increasing this value makes the output more robust but adds additional computations.

Confidence — Confidence percentage for finding maximum number of inliers

`99` (default) | numeric scalar

Confidence percentage for finding maximum number of inliers, specified as the comma-separated pair consisting of `'Confidence'` and a numeric scalar, in the range `[0 100]`. Increasing this value makes the output more robust but adds additional computations.

Output Arguments

model — Geometric model of plane

`planeModel` object

Geometric model of plane, returned as a `planeModel` object.

When the input point cloud does not contain enough valid points, or when the function cannot find enough inlier points, the coefficients for the output model are set to zero.

inlierIndices — Linear indices of inlier points

column vector

Linear indices of inlier points within the input point cloud, returned as a column vector.

outlierIndices — Linear indices of outlier points

column vector

Linear indices of outlier points within the input point cloud, returned as a column vector.

meanError — Mean square error

scalar value

Mean error of the distance of inlier points to the model, returned as a scalar value.

References

[1] Torr, P. H. S., and A. Zisserman. "MLESAC: A New Robust Estimator with Application to Estimating Image Geometry." *Computer Vision and Image Understanding*. 2000.

Extended Capabilities**C/C++ Code Generation**

Generate C and C++ code using MATLAB® Coder™.

GPU Code Generation

Generate CUDA® code for NVIDIA® GPUs using GPU Coder™.

Usage notes and limitations:

- For optimized CUDA code generation, the confidence percentage for finding maximum number of inliers is always set to 99.

See Also

`pointCloud` | `pcplayer` | `pcshow` | `pcwrite` | `pcread` | `pcfitsphere` | `pcfitcylinder` | `planeModel` | `pcmerge` | `pctransform` | `pcregistericp` | `pcdenoise` | `affine3d`

Topics

"3-D Point Cloud Registration and Stitching"

Introduced in R2015b

pcfitsphere

Fit sphere to 3-D point cloud

Syntax

```
model = pcfitsphere(ptCloudIn,maxDistance)
[model,inlierIndices,outlierIndices] = pcfitsphere(ptCloudIn,maxDistance)
[ ___,meanError] = pcfitsphere(ptCloudIn,maxDistance)
[ ___] = pcfitsphere( ___,Name,Value)
```

Description

`model = pcfitsphere(ptCloudIn,maxDistance)` fits a sphere to a point cloud that has a maximum allowable distance from an inlier point to the sphere. The function returns a geometrical model that describes the sphere.

This function uses the M-estimator SAMple Consensus (MSAC) algorithm to find the sphere. The MSAC algorithm is a variant of the RANdom SAMple Consensus (RANSAC) algorithm.

`[model,inlierIndices,outlierIndices] = pcfitsphere(ptCloudIn,maxDistance)` additionally returns linear indices to the inlier and outlier points in the point cloud input.

`[___,meanError] = pcfitsphere(ptCloudIn,maxDistance)` additionally returns the mean error of the distance of inlier points to the model, using any of the preceding syntaxes.

`[___] = pcfitsphere(___,Name,Value)` uses additional options specified by one or more `Name,Value` pair arguments.

Examples

Detect Sphere from Point Cloud

Load data file.

```
load('object3d.mat');
```

Display original point cloud.

```
figure
pcshow(ptCloud)
xlabel('X(m)')
ylabel('Y(m)')
zlabel('Z(m)')
title('Original Point Cloud')
```

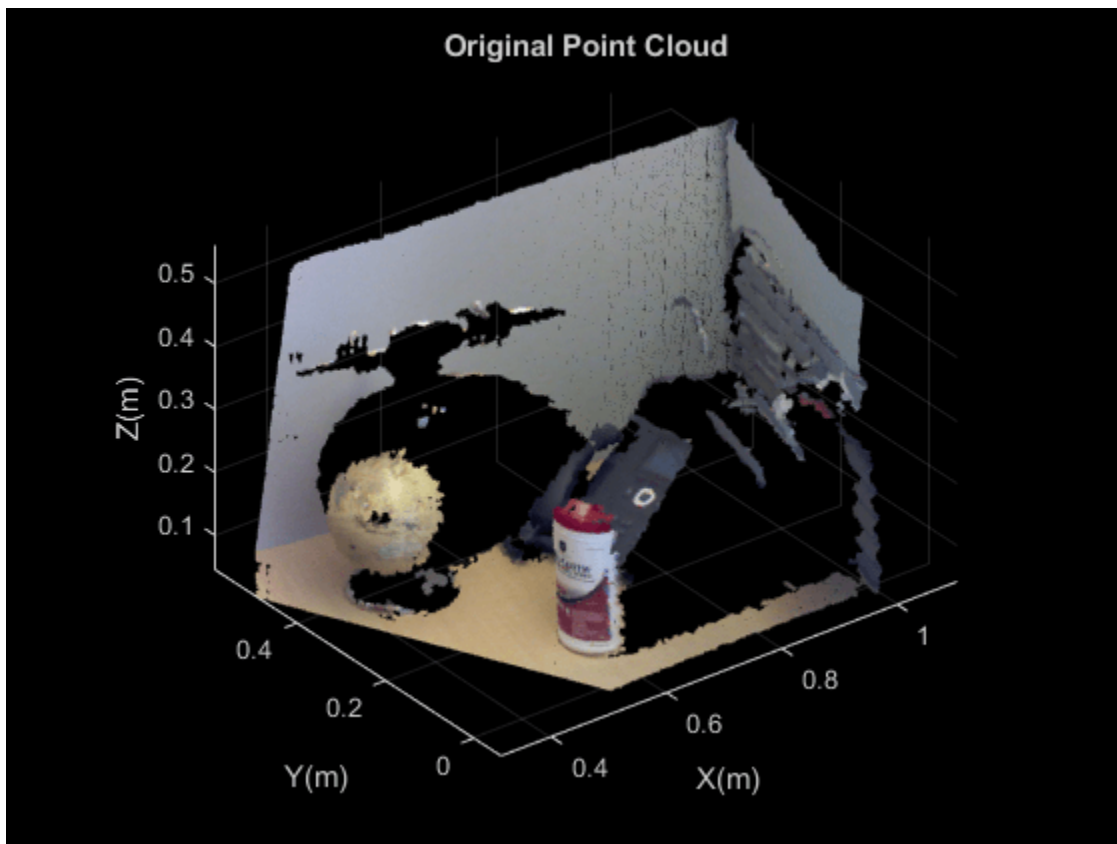

Set a maximum point-to-sphere distance of 1cm for sphere fitting.

```
maxDistance = 0.01;
```

Set the roi to constrain the search.

```
roi = [-inf,0.5,0.2,0.4,0.1,inf];
sampleIndices = findPointsInROI(ptCloud,roi);
```

Detect the sphere, a globe, and extract it from the point cloud.

```
[model,inlierIndices] = pcfitsphere(ptCloud,maxDistance,...
    'SampleIndices',sampleIndices);
globe = select(ptCloud,inlierIndices);
```

Plot the globe.

```
hold on
plot(model)
```

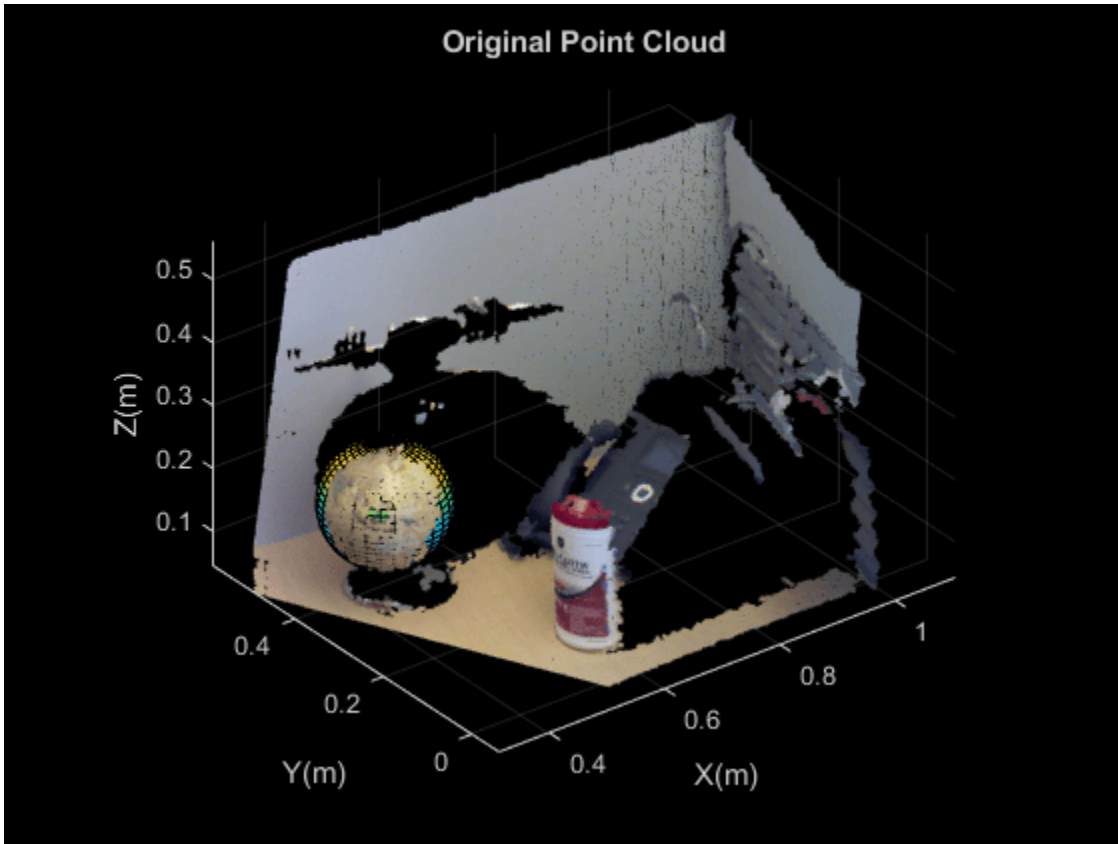

```
figure  
pcshow(globe)  
title('Globe Point Cloud')
```

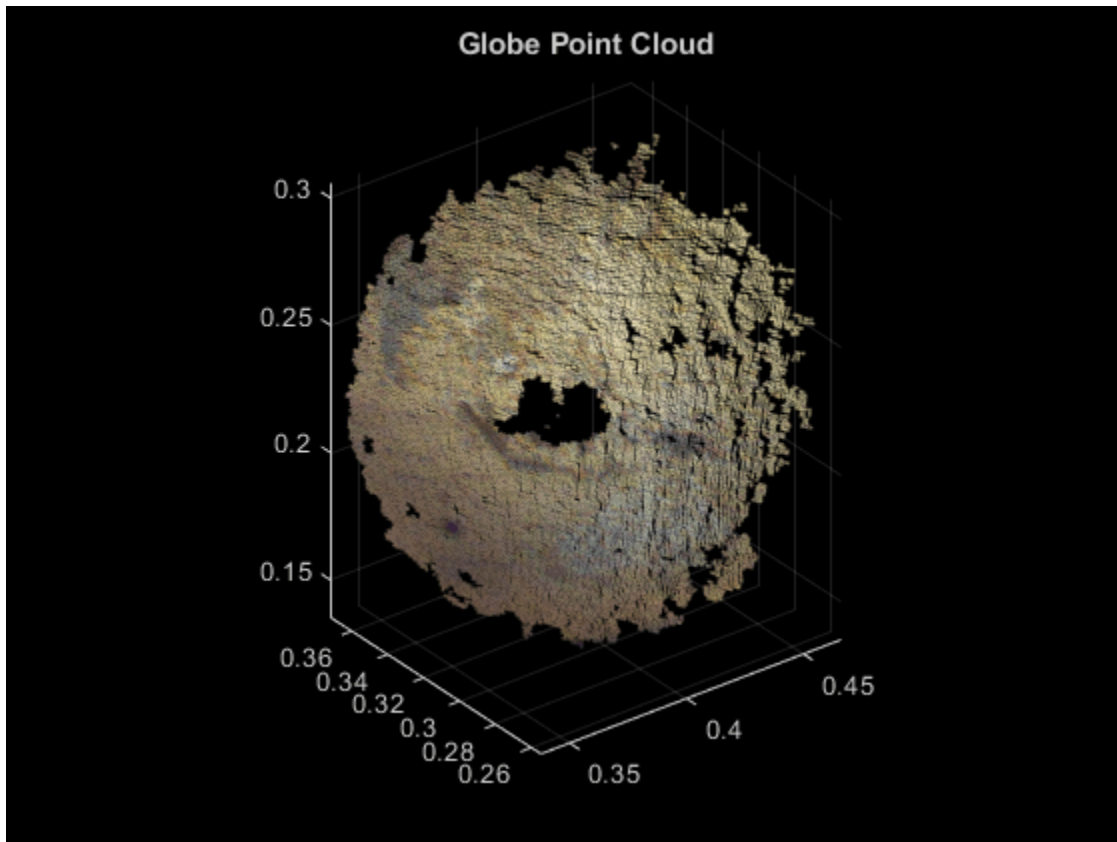

Input Arguments

ptCloudIn — Point cloud

pointCloud object

Point cloud, specified as a pointCloud object.

maxDistance — Maximum distance from an inlier point to the sphere

scalar value

Maximum distance from an inlier point to the sphere, specified as a scalar value. Specify the distance in units that are consistent with the units you are using for the point cloud.

Data Types: single | double

Name-Value Pair Arguments

Specify optional comma-separated pairs of Name, Value arguments. Name is the argument name and Value is the corresponding value. Name must appear inside quotes. You can specify several name and value pair arguments in any order as Name1, Value1, ..., NameN, ValueN.

Example: 'SampleIndices', [].

SampleIndices — Linear indices of points to be sampled

[] (default) | column vector

Linear indices of points to sample in the input point cloud, specified as the comma-separated pair consisting of 'SampleIndices' and a column vector. An empty vector means that all points are candidates to sample in the RANSAC iteration to fit the sphere. When you specify a subset, only points in the subset are sampled to fit a model. Providing a subset of points can significantly speed up the process and reduce the number of trials. You can generate the indices vector using the `findPointsInROI` method of the `pointCloud` object.

MaxNumTrials — Maximum number of random trials

1000 (default) | positive integer

Maximum number of random trials for finding inliers, specified as the comma-separated pair consisting of 'MaxNumTrials' and a positive integer. Increasing this value makes the output more robust but adds additional computations.

Confidence — Confidence percentage for finding maximum number of inliers

99 (default) | numeric scalar in the range [0,100]

Confidence percentage for finding maximum number of inliers, specified as the comma-separated pair consisting of 'Confidence' and a numeric scalar representing percentage, in the range [0,100]. Increasing this value makes the output more robust but adds additional computations.

Output Arguments

model — Geometric model of sphere

`sphereModel` object

Geometric model of sphere, returned as a `sphereModel` object.

When the input point cloud does not contain enough valid points, or when the function cannot find enough inlier points, the coefficients for the output model are set to zero.

inlierIndices — Linear indices of inlier points

column vector

Linear indices of inlier points within the input point cloud, returned as a column vector.

outlierIndices — Linear indices of outlier points

column vector

Linear indices of outlier points within the input point cloud, returned as a column vector.

meanError — Mean square error

scalar value

Mean error of the distance of inlier points to the model, returned as a scalar value.

References

- [1] Torr, P. H. S. and A. Zisserman. "MLE-SAC: A New Robust Estimator with Application to Estimating Image Geometry." *Computer Vision and Image Understanding*. 2000.

Extended Capabilities

C/C++ Code Generation

Generate C and C++ code using MATLAB® Coder™.

See Also

`pcfitplane` | `pcfitcylinder` | `pointCloud` | `pcplayer` | `pcshow` | `pcwrite` | `pcread` | `planeModel` | `pcmerge` | `pctransform` | `pcregistericp` | `pcdenoise` | `affine3d`

Topics

“3-D Point Cloud Registration and Stitching”

Introduced in R2015b

pixelLabelImageSource

(To be removed) Create datastore for semantic segmentation networks

Note `pixelLabelImageSource` will be removed in a future release. Create a pixel label image datastore using the `pixelLabelImageDatastore` function instead. For more information, see “Compatibility Considerations”.

Syntax

```
pximds = pixelLabelImageSource(gTruth)
pximds = pixelLabelImageSource(imds,pxds)
pximds = pixelLabelImageSource( ___,Name,Value)
```

Description

`pximds = pixelLabelImageSource(gTruth)` returns a pixel label image datastore for training a semantic segmentation network based on the input array of `groundTruth` objects. Use the output `pixelLabelImageDatastore` object with the Deep Learning Toolbox function `trainNetwork` to train convolutional neural networks for semantic segmentation.

`pximds = pixelLabelImageSource(imds,pxds)` returns a pixel label image datastore based on the input image datastore and the pixel label datastore objects. `imds` is an `ImageDatastore` object that represents the training input to the network. `pxds` is a `PixelLabelDatastore` object that represents the required network output.

`pximds = pixelLabelImageSource(___,Name,Value)` sets properties of the returned pixel label image datastore using name-value pairs. You can specify multiple name-value pairs. Enclose each argument name in quotes.

Examples

Augment Data While Training Using PixelLabelImageSource

Configure a pixel label image datastore to augment data while training. This example uses the `pixelLabelImageSource` function to create a pixel label image datastore object. For an example of the recommended workflow that uses the `pixelLabelImageDatastore` function to create a pixel label image datastore object, see “Augment Data While Training” on page 2-248.

Load training images and pixel labels.

```
dataSetDir = fullfile(toolboxdir('vision'),'visiondata','triangleImages');
imageDir = fullfile(dataSetDir,'trainingImages');
labelDir = fullfile(dataSetDir,'trainingLabels');
```

Create an `imageDatastore` object to hold the training images.

```
imds = imageDatastore(imageDir);
```

Define the class names and their associated label IDs.

```
classNames = ["triangle","background"];
labelIDs = [255 0];
```

Create a `pixelLabelDatastore` object to hold the ground truth pixel labels for the training images.

```
pxds = pixelLabelDatastore(labelDir, classNames, labelIDs);
```

Create an `imageDataAugmenter` object to randomly rotate and mirror image data.

```
augmenter = imageDataAugmenter('RandRotation',[-10 10],'RandXReflection',true)
```

```
augmenter =
    imageDataAugmenter with properties:
```

```
    FillValue: 0
    RandXReflection: 1
    RandYReflection: 0
    RandRotation: [-10 10]
    RandScale: [1 1]
    RandXScale: [1 1]
    RandYScale: [1 1]
    RandXShear: [0 0]
    RandYShear: [0 0]
    RandXTranslation: [0 0]
    RandYTranslation: [0 0]
```

Use the `pixelLabelImageSource` function to create a `pixelLabelImageDatastore` object that can be used to train the network with augmented data.

```
plimds = pixelLabelImageSource(imds,pxds,'DataAugmentation',augmenter)
```

```
plimds =
    pixelLabelImageDatastore with properties:
```

```
    Images: {200x1 cell}
    PixelLabelData: {200x1 cell}
    ClassNames: {2x1 cell}
    DataAugmentation: [1x1 imageDataAugmenter]
    ColorPreprocessing: 'none'
    OutputSize: []
    OutputSizeMode: 'resize'
    MiniBatchSize: 1
    NumObservations: 200
    DispatchInBackground: 0
```

Input Arguments

gTruth — Ground truth data

`groundTruth` object

Ground truth data, specified as a `groundTruth` object. You can use the **Image Labeler** to create a `groundTruth` object for training a semantic segmentation network.

imds — Collection of images

`ImageDatastore` object

Collection of images, specified as an `ImageDatastore` object.

pxds — Collection of pixel labeled images

`PixelLabelDatastore` object

Collection of pixel labeled images, specified as a `PixelLabelDatastore` object. The object contains the pixel labeled images for each image contained in the `imds` input object.

Name-Value Pair Arguments

Specify optional comma-separated pairs of `Name`, `Value` arguments. `Name` is the argument name and `Value` is the corresponding value. `Name` must appear inside quotes. You can specify several name and value pair arguments in any order as `Name1, Value1, ..., NameN, ValueN`.

Example: `'ColorProcessing', 'rgb2gray'`

DataAugmentation — Image data augmentation

`'none'` (default) | `imageDataAugmenter` object

Image data augmentation, specified as `'none'` or an `imageDataAugmenter` object. This argument sets the `DataAugmentation` on page 2-0 property of the returned pixel label image datastore, `pximds`.

ColorPreprocessing — Color channel preprocessing

`'none'` (default) | `'gray2rgb'` | `'rgb2gray'`

Color channel preprocessing, specified as `'none'`, `'gray2rgb'`, or `'rgb2gray'`. This argument sets the `ColorPreprocessing` on page 2-0 property of the returned pixel label image datastore, `pximds`. Use this property when you need the image data created by the data source must be only color or grayscale, but the training set includes both. Suppose you need to train a network that expects color images but some of your training images are grayscale. Set `ColorPreprocessing` to `'gray2rgb'` to replicate the color channels of the grayscale images in the input image set. Using the `'gray2rgb'` option creates M -by- N -by-3 output images.

OutputSize — Size of images produced by data source

`[]` (default) | 2-element vector

Size of images produced by data source, specified as a 2-element vector indicating the number of rows and columns. This argument sets the `OutputSize` on page 2-0 property of the returned pixel label image datastore, `pximds`. When you specify the `OutputSize`, image sizes are adjusted as necessary. By default, this property is empty, which means that the images are not adjusted.

OutputSizeMode — Technique used to adjust image sizes

`'false'` (default) | `'resize'` | `'centercrop'` | `'randcrop'`

Technique used to adjust image sizes, specified as `'false'`, `'resize'`, `'centercrop'`, or `'randcrop'`. This argument sets the `OutputSizeMode` on page 2-0 property of the returned pixel label image datastore, `pximds`. This property applies only when you set `OutputSize` to a value other than `[]`.

BackgroundExecution — Preprocess images in parallel

`false` (default) | `true`

Preprocess images in parallel, specified as `false` or `true`. This argument sets the `DispatchInBackground` on page 2-0 property of the returned pixel label image datastore

object, `pximds`. If `BackgroundExecution` is `true` and you have Parallel Computing Toolbox, then the pixel label image datastore asynchronously reads, augments, and queues pixel labeled images for use in training.

Output Arguments

pximds — Pixel label image datastore

`pixelLabelImageDatstore` object

Pixel label image datastore, returned as a `pixelLabelImageDatstore` object.

Compatibility Considerations

pixelLabelImageSource object is removed

In R2017b, you could create a `pixelLabelImageSource` object for training semantic segmentation networks. Starting in R2018a, the `pixelLabelImageSource` object has been removed. Use a `pixelLabelImageDatstore` object instead.

A `pixelLabelImageDatstore` has additional properties and methods to assist with data preprocessing. Unlike `pixelLabelImageSource`, which could be used for training only, you can use a `pixelLabelImageDatstore` for both training and prediction.

To create a `pixelLabelImageDatstore` object, you can use either the `pixelLabelImageDatstore` function (recommended) or the `pixelLabelImageSource` function.

pixelLabelImageSource function will be removed

Not recommended starting in R2018a

The `pixelLabelImageSource` function will be removed in a future release. Create a `pixelLabelImageDatstore` using the `pixelLabelImageDatstore` function instead.

To update your code, change instances of the function name `pixelLabelImageSource` to `pixelLabelImageDatstore`. You do not need to change the input arguments.

See Also

`pixelLabelImageDatstore`

Introduced in R2017b

pixelLabelTrainingData

Create training data for semantic segmentation from ground truth

Syntax

```
[imds,pxds] = pixelLabelTrainingData(gTruth)
[imds,pxds] = pixelLabelTrainingData(gTruth,Name,Value)
```

Description

`[imds,pxds] = pixelLabelTrainingData(gTruth)` creates image datastore `imds` and pixel label datastore `pxds` from the specified ground truth. You can combine the returned datastores into a `pixelLabelImageDatastore` and use the `trainNetwork` function to train deep learning segmentation networks. You can also use these datastores with the `evaluateSemanticSegmentation` function to evaluate the result from deep learning or classical segmentation methods.

This function supports parallel computing using multiple MATLAB workers. Enable parallel computing using the “Computer Vision Toolbox Preferences” dialog box.

`[imds,pxds] = pixelLabelTrainingData(gTruth,Name,Value)` returns image and pixel label datastores with additional options specified by one or more name-value pair arguments.

- If the `groundTruth` objects in `gTruth` were created using a video file, a custom data source, or an `imageDatastore` with different custom read functions, then you can specify any combination of name-value pair arguments.
- If the `groundTruth` objects were created from an image collection or image sequence data source, then you can specify only the `SamplingFactor` name-value pair argument

Examples

Prepare Data for Evaluating Semantic Segmentation Algorithm

Load a `groundTruth` object named `gTruth`. The ground truth contains pixel labels for triangles and background, annotated on a video with 100 frames.

```
visiondataPath = fullfile(matlabroot, 'toolbox', 'vision', 'visiondata');
addpath(fullfile(visiondataPath, 'triangleImages'));
addpath(fullfile(visiondataPath, 'triangleImages', 'testLabels'));
loadedData = load(fullfile(visiondataPath, 'triangleImages', 'triangleGroundTruth.mat'));
gTruth = loadedData.gTruth;
```

Create a folder in the current directory.

```
foldername = fullfile(tempdir, "videoFrames");
mkdir(foldername)
```

Create an `imageDatastore` and a `pixelLabelDatastore` from the video file and corresponding pixel labels. Write every fifth image to disk.

```
[imds,pxdsTruth] = pixelLabelTrainingData(gTruth,...
    'SamplingFactor',5,'WriteLocation',foldername);
```

Write images extracted for training to folder:
/tmp/videoFrames

Writing 20 images extracted from triangleVideo.avi...Completed.

Confirm that the temporary folder contains every fifth image.

imds.Files

```
ans = 20x1 cell
    {'/tmp/videoFrames/triangleVideo01.png'}
    {'/tmp/videoFrames/triangleVideo06.png'}
    {'/tmp/videoFrames/triangleVideo11.png'}
    {'/tmp/videoFrames/triangleVideo16.png'}
    {'/tmp/videoFrames/triangleVideo21.png'}
    {'/tmp/videoFrames/triangleVideo26.png'}
    {'/tmp/videoFrames/triangleVideo31.png'}
    {'/tmp/videoFrames/triangleVideo36.png'}
    {'/tmp/videoFrames/triangleVideo41.png'}
    {'/tmp/videoFrames/triangleVideo46.png'}
    {'/tmp/videoFrames/triangleVideo51.png'}
    {'/tmp/videoFrames/triangleVideo56.png'}
    {'/tmp/videoFrames/triangleVideo61.png'}
    {'/tmp/videoFrames/triangleVideo66.png'}
    {'/tmp/videoFrames/triangleVideo71.png'}
    {'/tmp/videoFrames/triangleVideo76.png'}
    {'/tmp/videoFrames/triangleVideo81.png'}
    {'/tmp/videoFrames/triangleVideo86.png'}
    {'/tmp/videoFrames/triangleVideo91.png'}
    {'/tmp/videoFrames/triangleVideo96.png'}
```

Remove the video and images from the path.

```
rmpath(fullfile(visiondataPath, 'triangleImages'));
rmpath(fullfile(visiondataPath, 'triangleImages', 'testLabels'));
```

Input Arguments

gTruth — Ground truth data

scalar groundTruth object | array of groundTruth objects

Ground truth data, specified as a scalar `groundTruth` object or an array of `groundTruth` objects. When `gTruth` is an array of `groundTruth` objects, the `LabelDefinitions` property of each object must contain the same pixel label names.

If you use custom data sources in `gTruth` with parallel computing enabled, then the reader function is expected to work with a pool of MATLAB workers to read images from the data source in parallel.

Name-Value Pair Arguments

Specify optional comma-separated pairs of `Name`, `Value` arguments. `Name` is the argument name and `Value` is the corresponding value. `Name` must appear inside quotes. You can specify several name and value pair arguments in any order as `Name1, Value1, ..., NameN, ValueN`.

Example: 'SamplingFactor',5

SamplingFactor — Factor for subsampling images

1 (default) | integer | vector of integers

Factor for subsampling images in the ground truth data source, specified an integer or a vector of integers. For a sampling factor of N , the returned training data includes every N th image in the ground truth data source. The function ignores ground truth images with empty label data

Use sampled data to reduce repeated data, such as a sequence of images with the same scene and labels. It can also help in reducing training time.

Value	Sampling Factor
Integer	Manually set the sampling factor to apply to all data.
Vector of integers	When you input a vector of ground truth objects, the function uses the sampling factor specified by the corresponding vector element.

ImageFormat — Image file format

PNG (default) | string scalar | character vector

Image file format, specified as the comma-separated pair consisting of 'ImageFormat' and a string scalar or character vector. File formats must be supported by `imwrite`. This argument applies only for `groundTruth` objects created using a video file or a custom data source.

WriteLocation — Name of folder

`pwd` (current working folder) (default) | string scalar | character vector

Folder name to write extracted images to, specified as a string scalar or character vector. The specified folder must exist and have write permissions.

This argument applies only for:

- `groundTruth` objects created using a video file or a custom data source.
- An array of `groundTruth` objects created using `imageDatastore` with different custom read functions.

The function ignores this argument when:

- The input `groundTruth` object was created from an image sequence data source.
- The array of input `groundTruth` objects all contain image datastores using the same custom read function.
- Any of the input `groundTruth` objects containing datastores, use the default read functions.

ImageFormat — Image file format

PNG (default) | string scalar | character vector

Image file format, specified as a string scalar or character vector. File formats must be supported by `imwrite`.

This argument applies only for:

- `groundTruth` objects created using a video file or a custom data source.
- An array of `groundTruth` objects created using `imageDatastore` with different custom `read` functions.

The function ignores this argument when:

- The input `groundTruth` object was created from an image sequence data source.
- The array of input `groundTruth` objects all contain image datastores using the same custom `read` function.
- Any of the input `groundTruth` objects containing datastores, use the default `read` functions.

NamePrefix — Prefix for output image file names

string scalar | character vector

Prefix for output image file names, specified as a string scalar or character vector. The image files are named as:

```
<name_prefix><source_number>_<image_number>.<image_format>
```

The default value uses the name of the data source that the images were extracted from, `strcat(sourceName, '_')` for video and custom data source, or `'datastore'` for image datastore.

This argument applies only for:

- `groundTruth` objects created using a video file or a custom data source.
- An array of `groundTruth` objects created using `imageDatastore` with custom `read` functions.

The function ignores this argument when:

- The input `groundTruth` object was created from an image sequence data source.
- The array of input `groundTruth` objects all contain image datastores using the same custom `read` function.
- Any of the input `groundTruth` objects containing datastores, use the default `read` functions.

Verbose — Display training progress

true (default) | false

Display training progress on the MATLAB command line, specified as the comma-separated pair consisting of `'Verbose'` and `true` or `false`. This argument applies only for `groundTruth` objects created using a video file or a custom data source.

Output Arguments

imds — Collection of images

`ImageDatastore` object

Collection of images extracted from the ground truth, `gTruth`, returned as an `ImageDatastore` object. Each image in `imds` has annotations with at least one class of pixel labels. `imds` ignores images that with no annotations.

pxds — Collection of pixel-labeled data

`PixelLabelDatastore` object

Collection of pixel-labeled data extracted from the ground truth, `gTruth`, returned as a `PixelLabelDatastore` object. The object contains a categorical matrix of pixel labels for each image contained in the image datastore, `imds`. Labels that do not correspond to pixel labels are ignored.

See Also

Apps

[Image Labeler](#) | [Video Labeler](#)

Functions

[objectDetectorTrainingData](#) | [semanticseg](#) | [evaluateSemanticSegmentation](#) | [trainNetwork](#)

Objects

[groundTruth](#) | [ImageDatastore](#) | [PixelLabelDatastore](#) | [pixelLabelImageDatastore](#)

Topics

[“Training Data for Object Detection and Semantic Segmentation”](#)

Introduced in R2018a

plotCamera

Plot a camera in 3-D coordinates

Syntax

```
cam = plotCamera
cam = plotCamera(cameraTable)
cam = plotCamera(Name,Value)
```

Description

`cam = plotCamera` plots a default camera in 3-D coordinates in the current axes. The function returns `cam`, a Camera object that contains the properties of the plotted camera.

`cam = plotCamera(cameraTable)` plots one or more cameras specified by `cameraTable`.

`cam = plotCamera(Name,Value)` specifies options using one or more name-value pair arguments. For example, `'Opacity',0.4` sets the opacity of the plotted camera to 0.4.

The name-value pair arguments set the associated properties of the plotted camera visualization object.

Examples

Plot Animated Camera Using Absolute Pose

Create a `rigid3d` object.

```
R = [1 0 0; 0 0 -1;0 1 0];
t = [10 0 20];
pose = rigid3d(R,t);
```

Plot a camera with an opacity of zero and an absolute pose based on the created `rigid3d` object.

```
cam = plotCamera('AbsolutePose',pose,'Opacity',0)
```

```
cam =
  Camera with properties:
    Parent: [1x1 Axes]
    Size: 1
  AbsolutePose: [1x1 rigid3d]
    Visible: 1
    AxesVisible: 0
  ButtonDownFcn: ''
    Color: [1 0 0]
    Opacity: 0
    Label: ''
```

Set viewing properties for the current axes.

```
grid on  
axis equal  
axis manual
```

Expand the viewable limits of each axis. These changes enable the entire animation to be visible in the next step.

```
xlim([-15 20]);  
ylim([-15 20]);  
zlim([15 25]);
```

Rotate the camera around the y-axis.

```
for theta = 0:pi/64:10*pi  
    T = [cos(theta) 0 sin(theta); 0 1 0; -sin(theta) 0 cos(theta)];  
    cam.AbsolutePose = rigid3d(T * R, [10 * cos(theta), 10 * sin(theta), 20]);  
    drawnow();  
end
```

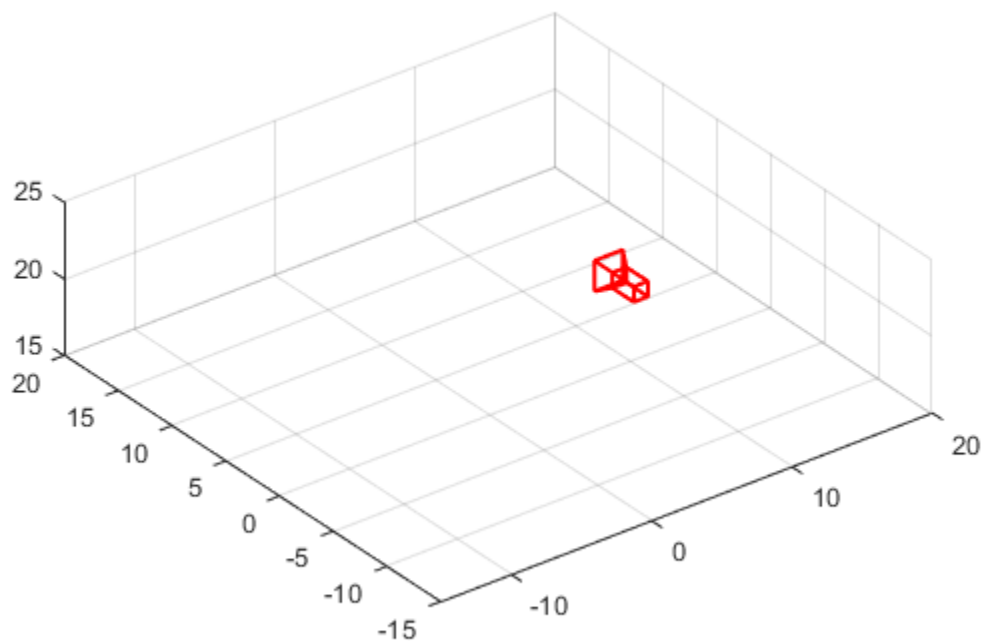

Visualize Camera Extrinsic

Create a set of calibration images.

```
images = imageSet(fullfile(toolboxdir('vision'),'visiondata','calibration','slr'));
```

Detect the checkerboard corners in the images.

```
[imagePoints,boardSize] = detectCheckerboardPoints(images.ImageLocation);
```

Generate the world coordinates of the checkerboard corners in the pattern-centric coordinate system, with the upper-left corner at (0,0). Set the square size to 29 mm.

```
squareSize = 29;
worldPoints = generateCheckerboardPoints(boardSize,squareSize);
```

Calibrate the camera.

```
cameraParams = estimateCameraParameters(imagePoints,worldPoints);
```

Load an image at its new location.

```
imOrig = imread(fullfile(toolboxdir('vision'),'visiondata','calibration','slr','image9.jpg'));
figure; imshow(imOrig,'InitialMagnification',50);
title('Input Image');
```

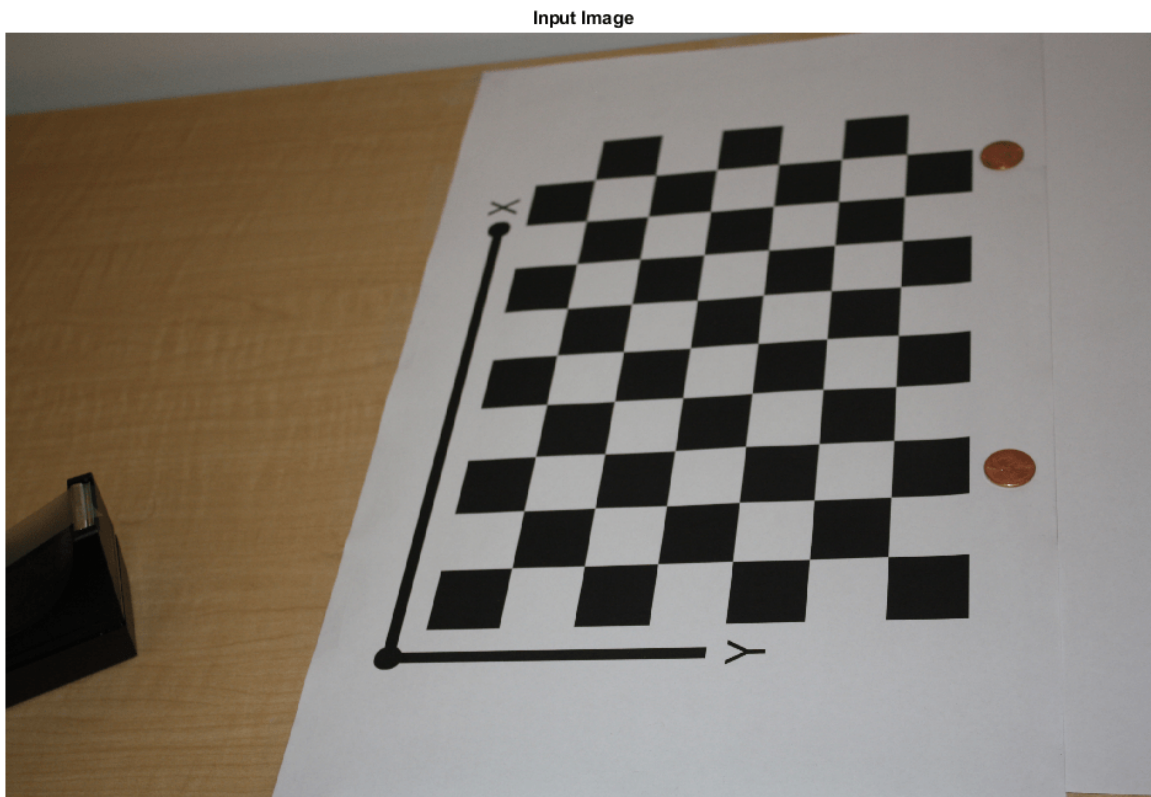

Undistort the image.

```
im = undistortImage(imOrig,cameraParams);
```

Find the reference object in the new image.

```
[imagePoints,boardSize] = detectCheckerboardPoints(im);
```

Compute the new extrinsics.

```
[rotationMatrix,translationVector] = extrinsics(imagePoints,worldPoints,cameraParams);
```

Plot the world points.

```
figure;  
plot3(worldPoints(:,1),worldPoints(:,2),zeros(size(worldPoints, 1),1),'*');  
hold on
```

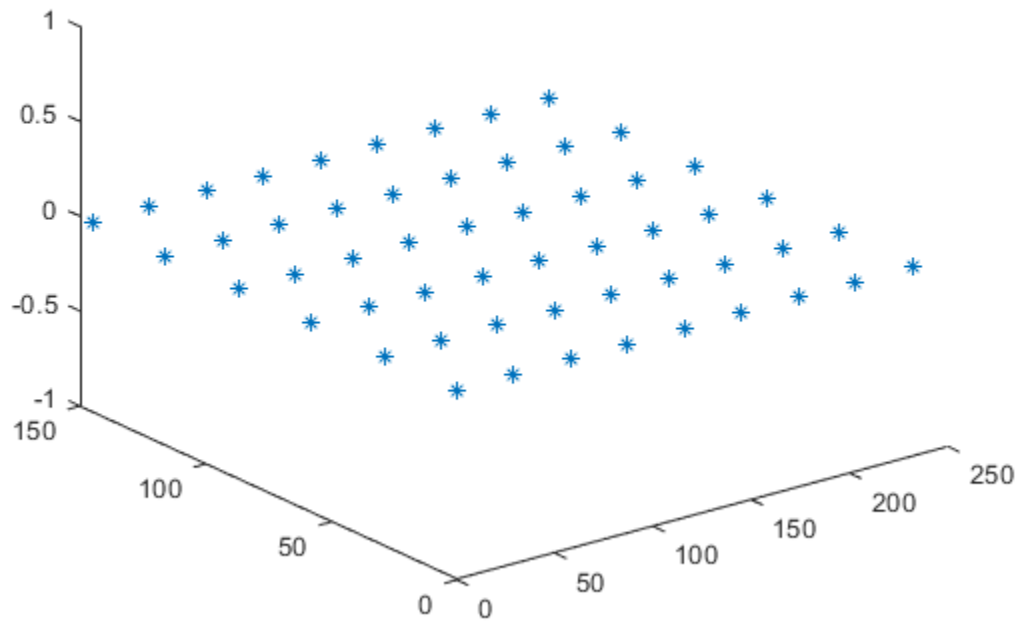

Mark the origin.

```
plot3(0,0,0,'g*');
```

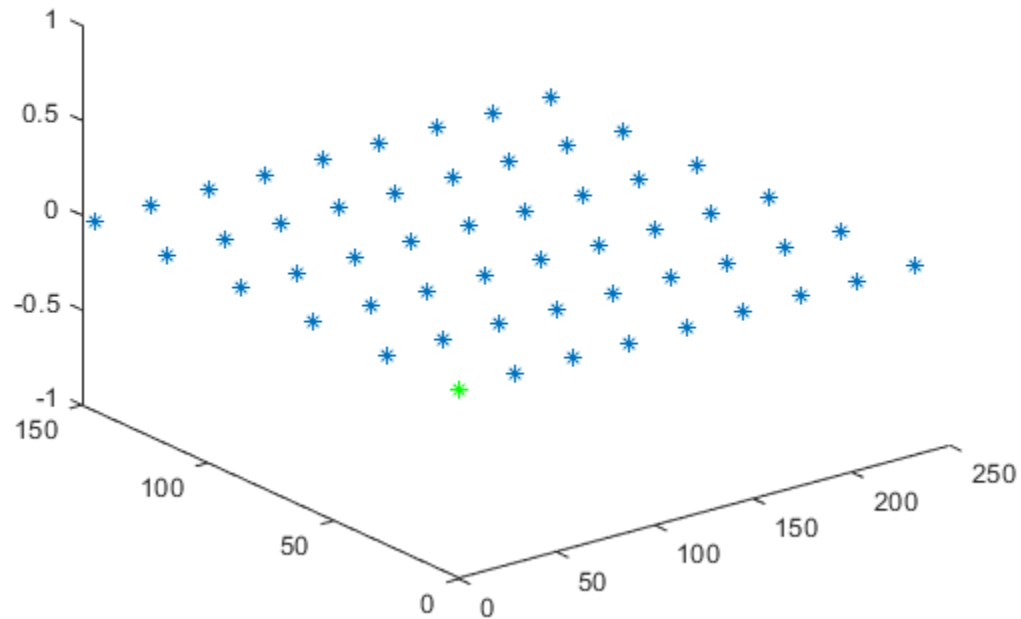

Compute the camera location and orientation.

```
orientation = rotationMatrix';  
location = -translationVector * orientation;
```

Plot the camera.

```
absPose = rigid3d(orientation,location);  
cam = plotCamera('AbsolutePose',absPose,'Size',20);
```

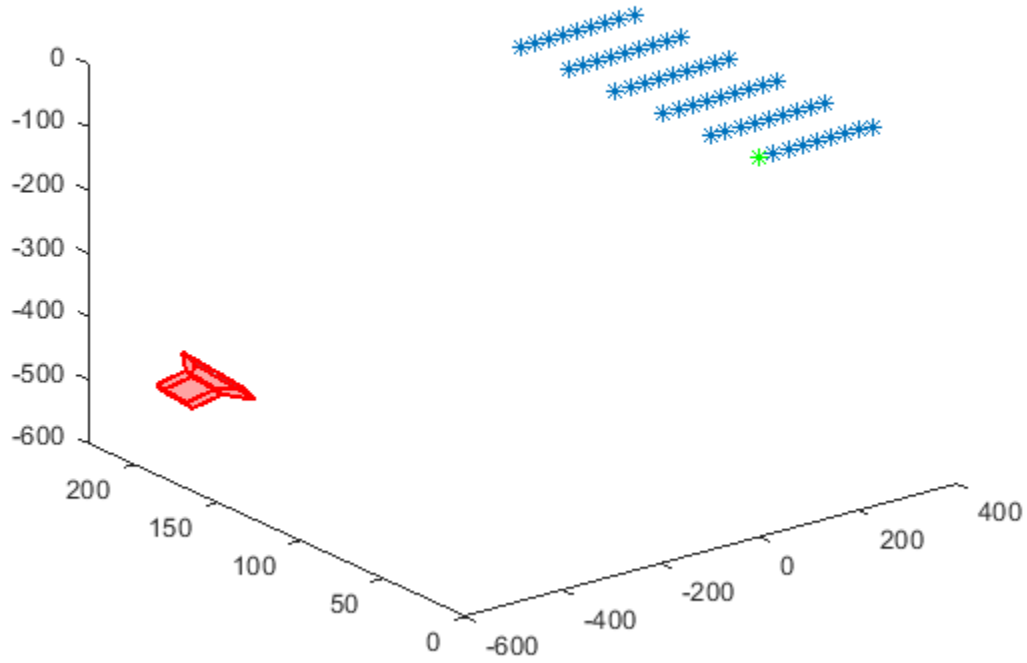

Make the z -axis point down.

```
set(gca, 'CameraUpVector', [0 0 -1]);
```

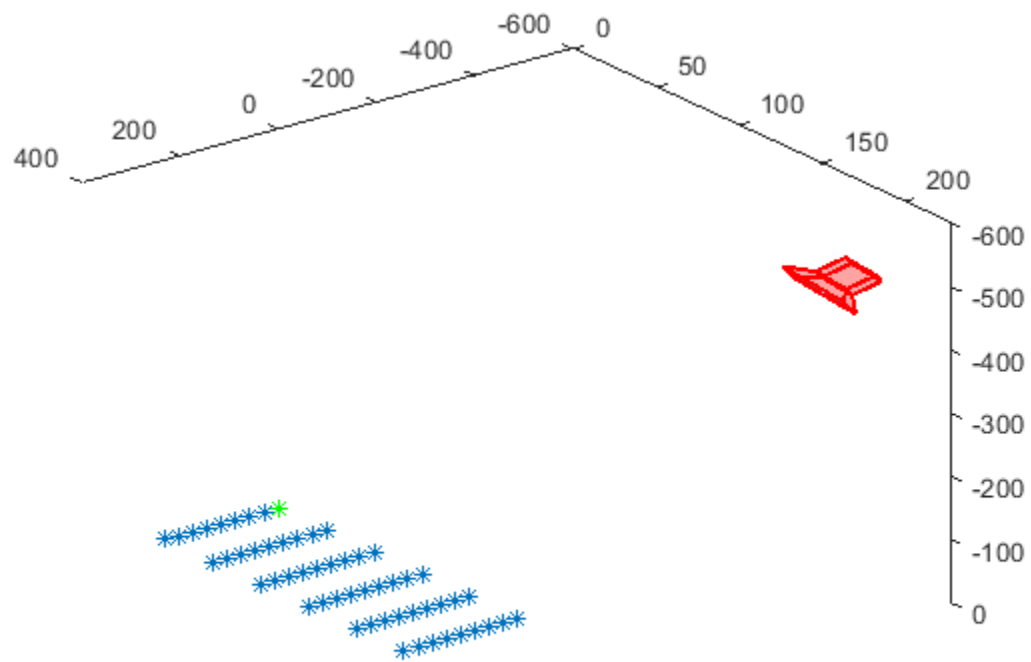
Set the view parameters.

```
camorbit(gca, -110, 60, 'data', [0 0 1]);  
axis equal  
grid on
```

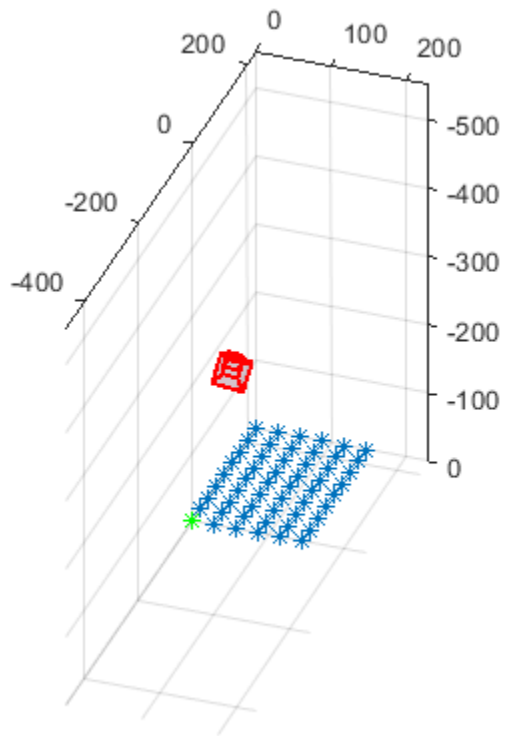

Turn on 3-D rotation.

```
cameratoolbar('SetMode','orbit');
```

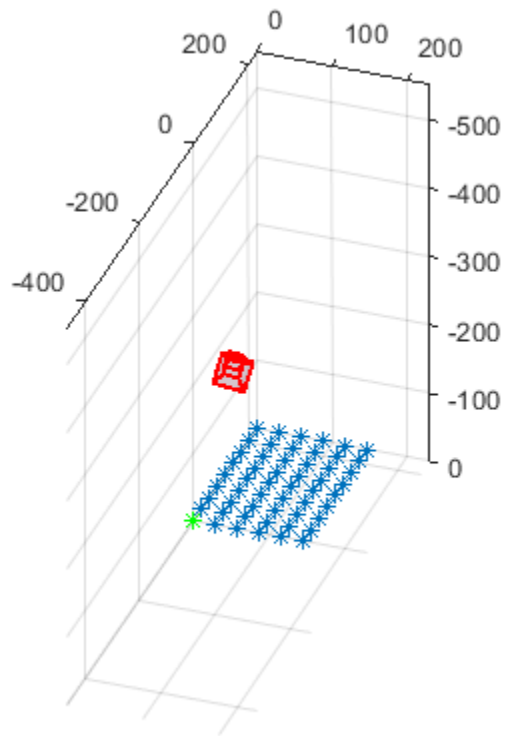

Label the axes.

```
xlabel('X (mm)');  
ylabel('Y (mm)');  
zlabel('Z (mm)');
```

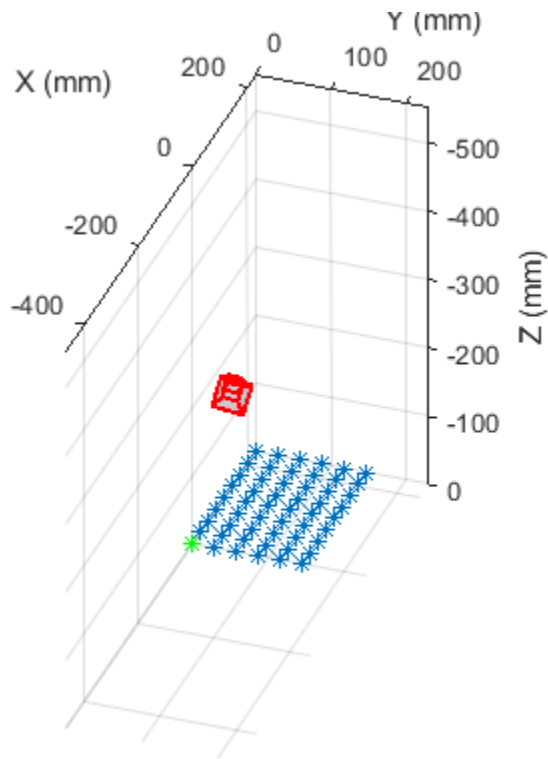

Input Arguments

cameraTable — Properties of cameras for visualization

table

Properties of cameras for visualization, specified as a table. Each row represents a single camera. Each column title must match the name-part of a name-value pair argument. The n th-row values set the properties for the n th element of `cam`. You cannot specify values for 'Parent'. If the table contains a 'ViewId' column, then the view IDs are used to set the 'Label' values of the cameras.

Name-Value Pair Arguments

Specify optional comma-separated pairs of `Name`, `Value` arguments. `Name` is the argument name and `Value` is the corresponding value. `Name` must appear inside quotes. You can specify several name and value pair arguments in any order as `Name1`, `Value1`, ..., `NameN`, `ValueN`.

Example: 'Size',0.3 specifies the camera-base width as 0.3.

AbsolutePose — Camera absolute pose

rigid3d object

Camera absolute pose in the world coordinate system, specified as the comma-separated pair consisting of 'AbsolutePose' a rigid3d object.

Size — Camera-base width

1 (default) | positive real number

Camera-base width, specified as the comma-separated pair consisting of 'Size' and a positive real number.

Label — Camera label

' ' (default) | character vector | string scalar

Camera label, specified as the comma-separated pair consisting of 'Label' and a character vector or a string scalar.

Color — Camera color

[1 0 0] (red) (default) | RGB triplet

Camera color, specified as the comma-separated pair consisting of 'Color' and an RGB triplet. An RGB triplet is a three-element row vector whose elements specify the intensities of the red, green, and blue components of the color. The intensities must be in the range [0, 1].

Opacity — Camera opacity

0.2 (default) | scalar in the range [0,1]

Camera opacity, specified as the comma-separated pair consisting of 'Opacity' and a scalar in the range [0,1].

Visible — Camera visibility

true or 1 (default) | false or 0

Camera visibility, specified as the comma-separated pair consisting of 'Visible' and a numeric or logical 1 (true) or 0 (false).

AxesVisible — Camera axes visibility

false or 0 (default) | true or 1

Camera axes visibility, specified as the comma-separated pair consisting of 'AxesVisible' and a numeric or logical 1 (true) or 0 (false).

ButtonDownFcn — Callback function

' ' (default) | function handle

Callback function, specified as the comma-separated pair consisting of 'ButtonDownFcn' and a function handle that executes when you click the camera.

Parent — Output axes

axes handle

Output axes, specified as the comma-separated pair consisting of 'Parent' and an axes handle. By default, plotCamera uses the current axes handle. To return the current axes, use the gca function.

Output Arguments**cam — Camera visualization object**

Camera object | row vector of Camera objects

Camera visualization object, returned as one of these options.

- Camera object — The function returns this option when plotting a single camera. Name-value pair arguments or `cameraTable` input elements set the corresponding `Camera` object properties.
- Row vector of Camera objects — The function returns this option when plotting multiple cameras. The *n*th -row values of the `cameraTable` input set the properties for the *n*th `Camera` object in this vector.

Camera objects are created using the `vision.graphics.Camera` class.

See Also

Functions

`extrinsics` | `showExtrinsics`

Objects

`rigid3d`

Topics

“Structure From Motion From Two Views”

“3-D Coordinate Systems”

“Using the Single Camera Calibrator App”

“Using the Stereo Camera Calibrator App”

Introduced in R2015a

ransac

Fit model to noisy data

Syntax

```
[model,inlierIdx] = ransac(data,fitFcn,distFcn,sampleSize,maxDistance)  
[ ___ ] = ransac( ___ ,Name,Value)
```

Description

[model,inlierIdx] = ransac(data,fitFcn,distFcn,sampleSize,maxDistance) fits a model to noisy data using the M-estimator sample consensus (MSAC) algorithm, a version of the random sample consensus (RANSAC) algorithm.

Specify your function for fitting a model, fitFcn, and your function for calculating distances from the model to your data, distFcn. The ransac function takes random samples from your data using sampleSize and uses the fit function to maximize the number of inliers within maxDistance.

[___] = ransac(___ ,Name,Value) additionally specifies one or more Name,Value pair arguments.

Examples

Fit Line to 2-D Points Using Least Squares and RANSAC Algorithms

Load and plot a set of noisy 2-D points.

```
load pointsForLineFitting.mat  
plot(points(:,1),points(:,2),'o');  
hold on
```

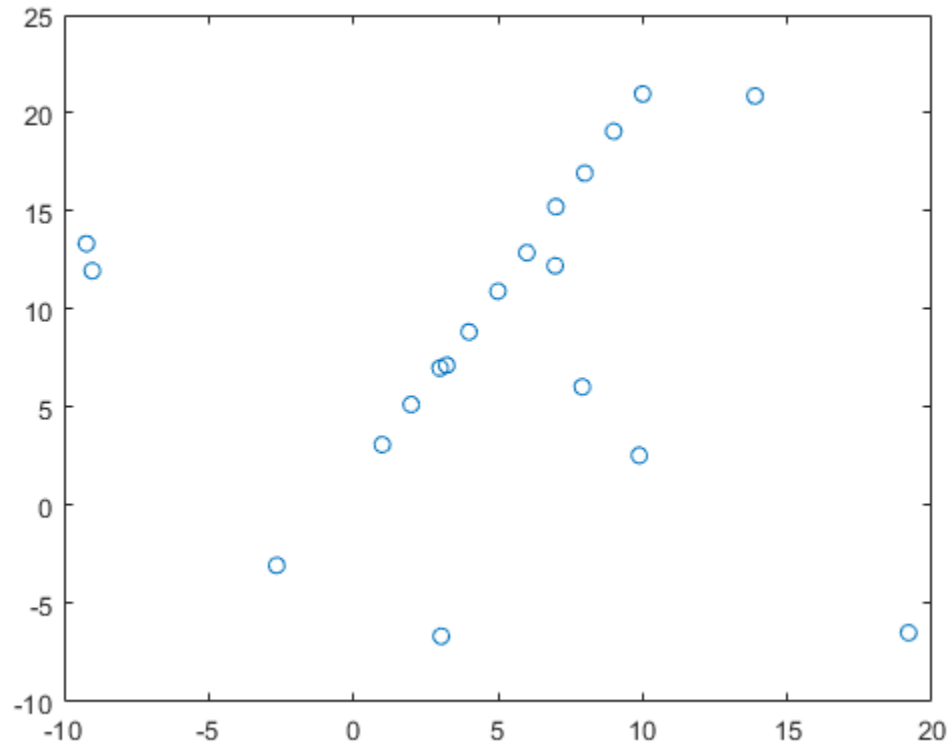

Fit a line using linear least squares. Due to outliers, the line is not a good fit.

```
modelLeastSquares = polyfit(points(:,1),points(:,2),1);  
x = [min(points(:,1)) max(points(:,1))];  
y = modelLeastSquares(1)*x + modelLeastSquares(2);  
plot(x,y, 'r-')
```

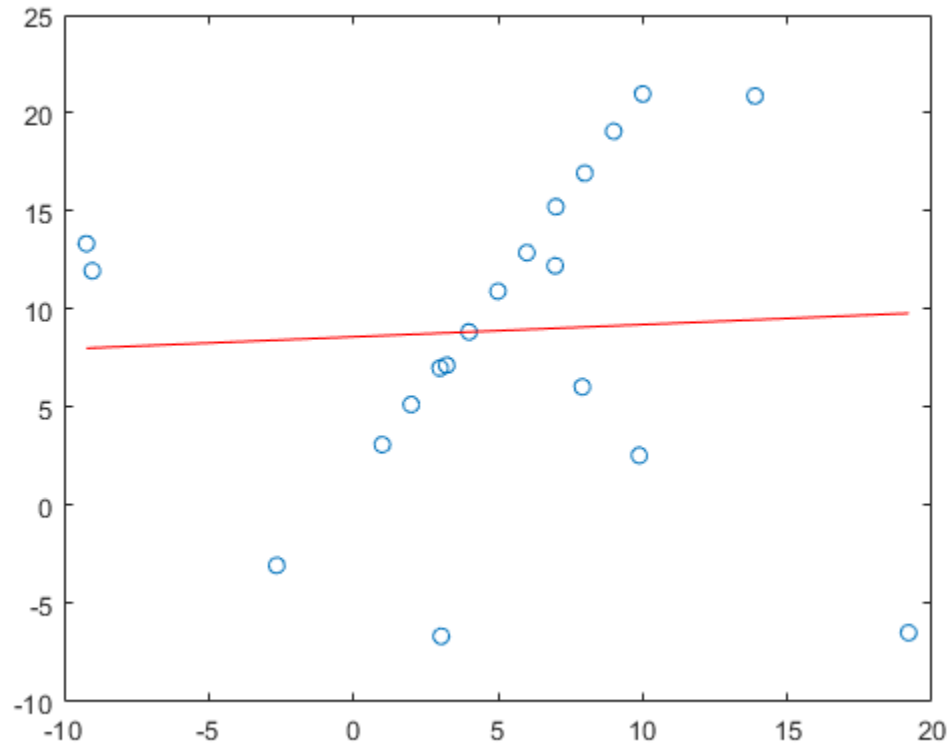
Fit a line to the points using the MSAC algorithm. Define the sample size, the maximum distance for inliers, the fit function, and the distance evaluation function. Call `ransac` to run the MSAC algorithm.

```
sampleSize = 2; % number of points to sample per trial
maxDistance = 2; % max allowable distance for inliers

fitLineFcn = @(points) polyfit(points(:,1),points(:,2),1); % fit function using polyfit
evalLineFcn = ... % distance evaluation function
    @(model, points) sum((points(:, 2) - polyval(model, points(:,1))).^2,2);

[modelRANSAC, inlierIdx] = ransac(points,fitLineFcn,evalLineFcn, ...
    sampleSize,maxDistance);

Refit a line to the inliers using polyfit.

modelInliers = polyfit(points(inlierIdx,1),points(inlierIdx,2),1);

Display the final fit line. This line is robust to the outliers that ransac identified and ignored.

inlierPts = points(inlierIdx,:);
x = [min(inlierPts(:,1)) max(inlierPts(:,1))];
y = modelInliers(1)*x + modelInliers(2);
plot(x, y, 'g-')
legend('Noisy points','Least squares fit','Robust fit');
hold off
```

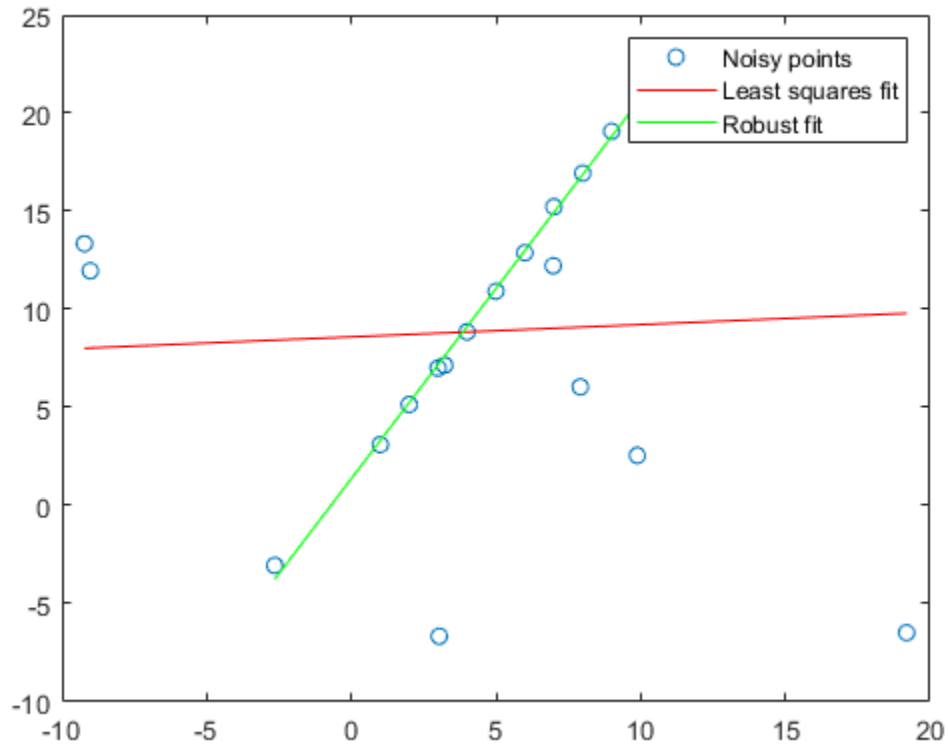

Input Arguments

data — Data to be modeled

m-by-*n* matrix

Data to be modeled, specified as an *m*-by-*n* matrix. Each row corresponds to a data point in the set to be modeled. For example, to model a set of 2-D points, specify the point data as an *m*-by-2 matrix.

Data Types: single | double

fitFcn — Function to fit a subset of data

function handle

Function to fit a subset of data, specified as a function handle. The function must be of the form:

```
model = fitFcn(data)
```

If it is possible to fit multiple models to the data, then `fitFcn` returns the model parameters as a cell array.

distFcn — Function to compute distances from model

function handle

Function to compute distances from the model to the data, specified as a function handle. The function must be of the form:

```
distances = distFcn(model,data)
```

If `model` is an n -element array, then `distances` must be an m -by- n matrix. Otherwise, `distances` must be an m -by-1 vector.

sampleSize — Minimum sample size

positive scalar integer

Minimum sample size from `data` that is required by `fitFcn`, specified as a positive scalar integer.

maxDistance — Maximum distance for inlier points

positive scalar

Maximum distance from the fit curve to an inlier point, specified as a positive scalar. Any points further away than this distance are considered outliers. The RANSAC algorithm creates a fit from a small sample of points, but tries to maximize the number of inlier points. Lowering the maximum distance improves the fit by putting a tighter tolerance on inlier points.

Name-Value Pair Arguments

Specify optional comma-separated pairs of `Name`, `Value` arguments. `Name` is the argument name and `Value` is the corresponding value. `Name` must appear inside quotes. You can specify several name and value pair arguments in any order as `Name1, Value1, ..., NameN, ValueN`.

Example: `'MaxNumTrials', 2000`

ValidateModelFcn — Function to validate model

function handle

Function to validate model, specified as the comma-separated pair consisting of `'ValidateModelFcn'` and a function handle. The function returns `true` if the model is accepted based on criteria defined in the function. Use this function to reject specific fits. The function must be of the form:

```
isValid = validateModelFcn(model,varargin)
```

If no function is specified, all models are assumed to be valid.

MaxSamplingAttempts — Maximum number of sampling attempts

100 (default) | integer

Maximum number of attempts to find a sample that yields a valid model, specified as the comma-separated pair consisting of `'MaxSamplingAttempts'` and an integer.

MaxNumTrials — Maximum number of random trials

1000 (default) | integer

Maximum number of random trials, specified as the comma-separated pair consisting of `'MaxNumTrials'` and an integer. A single trial uses a minimum number of random points from `data` to fit a model. Then, the trial checks the number of inliers within the `maxDistance` from the model. After all trials, the model with the highest number of inliers is selected. Increasing the number of trials improves the robustness of the output at the expense of additional computation.

Confidence — Confidence of final solution

99 (default) | scalar from 0 to 100

Confidence that the final solution finds the maximum number of inliers for the model fit, specified as the comma-separated pair consisting of 'Confidence' and a scalar from 0 to 100. Increasing this value improves the robustness of the output at the expense of additional computation.

Output Arguments

model — Best fit model

parameters defined in `fitFcn`

Best fit model, returned as the parameters defined in the `fitFcn` input. This model maximizes the number of inliers from all the sample attempts.

inlierIdx — Inlier points

logical vector

Inlier points, returned as a logical vector. The vector is the same length as `data`, and each element indicates if that point is an inlier for the model fit based on `maxDistance`.

References

- [1] Torr, P. H. S., and A. Zisserman. "MLE-SAC: A New Robust Estimator with Application to Estimating Image Geometry." *Computer Vision and Image Understanding*. Vol. 18, Issue 1, April 2000, pp. 138-156.

Extended Capabilities

C/C++ Code Generation

Generate C and C++ code using MATLAB® Coder™.

See Also

`fitPolynomialRANSAC` | `polyfit` | `polyval`

Introduced in R2017a

reconstructScene

Reconstruct 3-D scene from disparity map

Syntax

```
xyzPoints = reconstructScene(disparityMap, stereoParams)
```

Description

`xyzPoints = reconstructScene(disparityMap, stereoParams)` returns an array of 3-D world point coordinates that reconstruct a scene from a disparity map. The `stereoParams` input must be the same input that you use to rectify the stereo images corresponding to the disparity map.

Examples

Reconstruct 3-D Scene from Disparity Map

Load the stereo parameters.

```
load('webcamsSceneReconstruction.mat');
```

Read in the stereo pair of images.

```
I1 = imread('sceneReconstructionLeft.jpg');  
I2 = imread('sceneReconstructionRight.jpg');
```

Rectify the images.

```
[J1, J2] = rectifyStereoImages(I1, I2, stereoParams);
```

Display the images after rectification.

```
figure  
imshow(cat(3, J1(:, :, 1), J2(:, :, 2:3)), 'InitialMagnification', 50);
```



Compute the disparity.

```
disparityMap = disparitySGM(im2gray(J1),im2gray(J2));  
figure  
imshow(disparityMap,[0,64], 'InitialMagnification',50);
```



Reconstruct the 3-D world coordinates of points corresponding to each pixel from the disparity map.

```
xyzPoints = reconstructScene(disparityMap, stereoParams);
```

Segment out a person located between 3.2 and 3.7 meters away from the camera.

```
Z = xyzPoints(:,:,3);
mask = repmat(Z > 3200 & Z < 3700, [1,1,3]);
J1(~mask) = 0;
imshow(J1, 'InitialMagnification', 50);
```



Input Arguments

disparityMap — Disparity image

2-D array

Disparity image, specified as a 2-D array of disparity values for pixels in image 1 of a stereo pair. You can use either `disparityBM` or `disparitySGM` functions to generate the disparity image.

The disparity image can contain invalid values marked as `NaN`. These values correspond to pixels in image 1 that did not match with image 2. The function sets the world coordinates corresponding to invalid disparity value to `NaN`.

Pixels with zero disparity correspond to world points that are too far away to measure, given the resolution of the camera. The function sets the world coordinates corresponding to zero disparity to `Inf`.

When you specify the `disparityMap` input as a `double`, the function returns the coordinates as `double`. Otherwise, the function returns the coordinates as `single`.

Data Types: `single` | `double`

stereoParams — Stereo camera system parameters

`stereoParameters` object

Stereo camera system parameters, specified as a `stereoParameters` object.

Data Types: `uint8` | `uint16` | `int16` | `single` | `double`

Output Arguments

xyzPoints — Coordinates of world points

M -by- N -by-3 array

Coordinates of world points, returned as an M -by- N -by-3 array. The 3-D world coordinates are relative to the optical center of camera 1 in the stereo system represented by `stereoParams`.

The output array contains the $[x, y, z]$ coordinates of world points that correspond to the pixels in the `disparityMap` input. `xyzPoints(:, :, 1)` contains the x world coordinates of points corresponding to the pixels in the disparity map. `xyzPoints(:, :, 2)` contains the y world coordinates, and `xyzPoints(:, :, 3)` contains the z world coordinates. The 3-D world coordinates are relative to the optical center of camera 1 in the stereo system.

When you specify the `disparityMap` input as `double`, the function returns the `xyzPoints` output as `double`. Otherwise, the function returns it as `single`.

Data Types: `single` | `double`

References

[1] G. Bradski and A. Kaehler, *Learning OpenCV : Computer Vision with the OpenCV Library*, Sebastopol, CA: O'Reilly, 2008.

Extended Capabilities

C/C++ Code Generation

Generate C and C++ code using MATLAB® Coder™.

Usage notes and limitations:

- Use in a MATLAB Function block is not supported.

See Also

Functions

`disparitySGM` | `disparityBM` | `estimateCameraParameters` | `size` | `rectifyStereoImages` | `lineToBorderPoints`

Objects

`cameraParameters` | `stereoParameters`

Topics

“Structure From Motion From Two Views”

“Code Generation for Depth Estimation From Stereo Video”
“Coordinate Systems”

Introduced in R2014a

rectifyStereoImages

Rectify a pair of stereo images

Syntax

```
[J1,J2] = rectifyStereoImages(I1,I2, stereoParams)
[J1,J2] = rectifyStereoImages(I1,I2,tform1,tform2)

[J1,J2] = rectifyStereoImages( ____,interp)
[J1,J2] = rectifyStereoImages( ____,Name,Value)
```

Description

`[J1,J2] = rectifyStereoImages(I1,I2, stereoParams)` returns undistorted and rectified versions of `I1` and `I2` input images using the stereo parameters stored in the `stereoParams` object.

Stereo image rectification projects images onto a common image plane in such a way that the corresponding points have the same row coordinates. This image projection makes the image appear as though the two cameras are parallel. Use the `disparityBM` or `disparitySGM` functions to compute a disparity map from the rectified images for 3-D scene reconstruction.

`[J1,J2] = rectifyStereoImages(I1,I2,tform1,tform2)` returns rectified versions of `I1` and `I2` input images by applying projective transformations `tform1` and `tform2`. The projective transformations are returned by the `estimateUncalibratedRectification` function.

`[J1,J2] = rectifyStereoImages(____,interp)` additionally specifies the interpolation method to use for rectified images. You can specify the method as `'nearest'`, `'linear'`, or `'cubic'`.

`[J1,J2] = rectifyStereoImages(____,Name,Value)` uses additional options specified by one or more `Name,Value` pair arguments.

Examples

Rectify Stereo Images

Specify images containing a checkerboard for calibration.

```
imageDir = fullfile(toolboxdir('vision'),'visiondata', ...
    'calibration','stereo');
leftImages = imageDatastore(fullfile(imageDir,'left'));
rightImages = imageDatastore(fullfile(imageDir,'right'));
```

Detect the checkerboards.

```
[imagePoints,boardSize] = detectCheckerboardPoints(...
    leftImages.Files,rightImages.Files);
```

Specify world coordinates of checkerboard keypoints.

```
squareSizeInMillimeters = 108;
worldPoints = generateCheckerboardPoints(boardSize,squareSizeInMillimeters);
```

Read in the images.

```
I1 = readimage(leftImages,1);  
I2 = readimage(rightImages,1);  
imageSize = [size(I1,1),size(I1,2)];
```

Calibrate the stereo camera system.

```
stereoParams = estimateCameraParameters(imagePoints,worldPoints, ...  
                                       'ImageSize',imageSize);
```

Rectify the images using 'full' output view.

```
[J1_full,J2_full] = rectifyStereoImages(I1,I2,stereoParams, ...  
                                       'OutputView','full');
```

Display the result for 'full' output view.

```
figure;  
imshow(stereoAnaglyph(J1_full,J2_full));
```

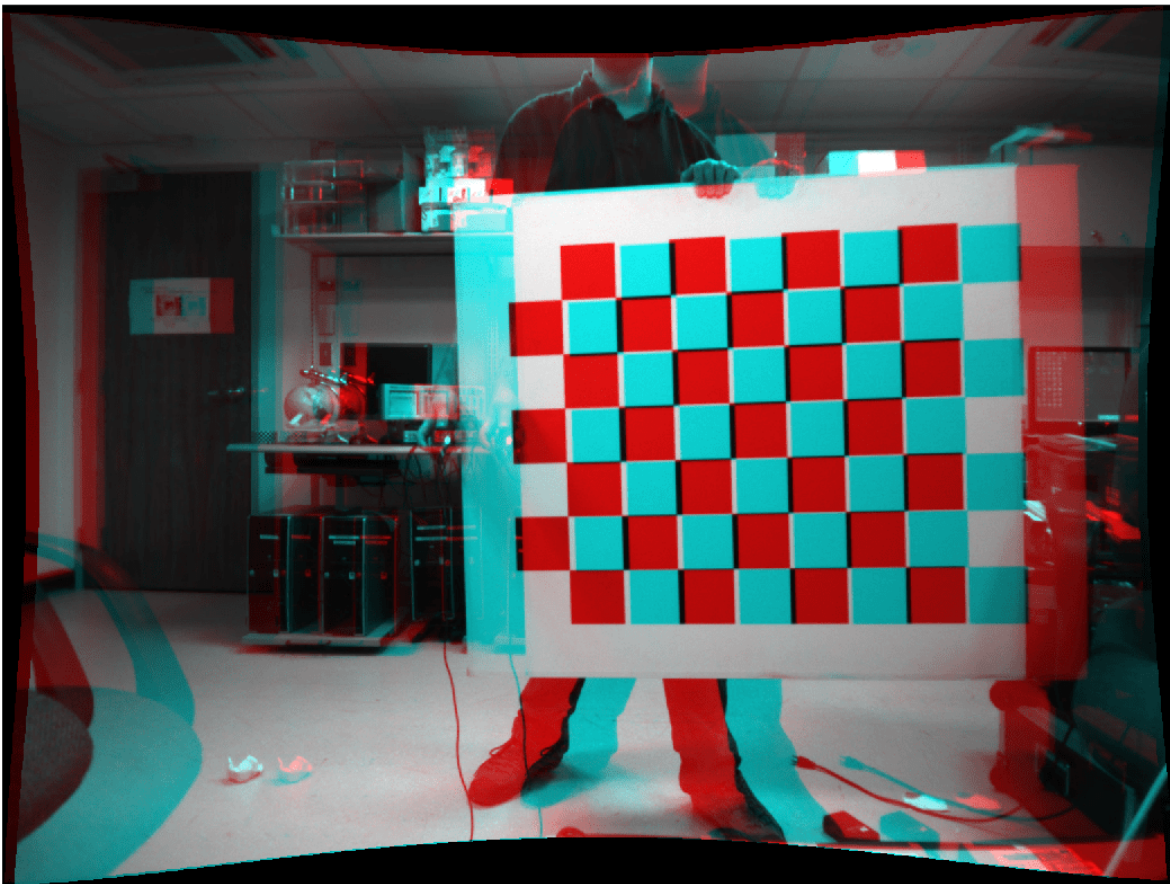

Rectify the images using 'valid' output view. This is most suitable for computing disparity.

```
[J1_valid,J2_valid] = rectifyStereoImages(I1,I2,stereoParams, ...  
    'OutputView','valid');
```

Display the result for 'valid' output view.

```
figure;  
imshow(stereoAnaglyph(J1_valid,J2_valid));
```

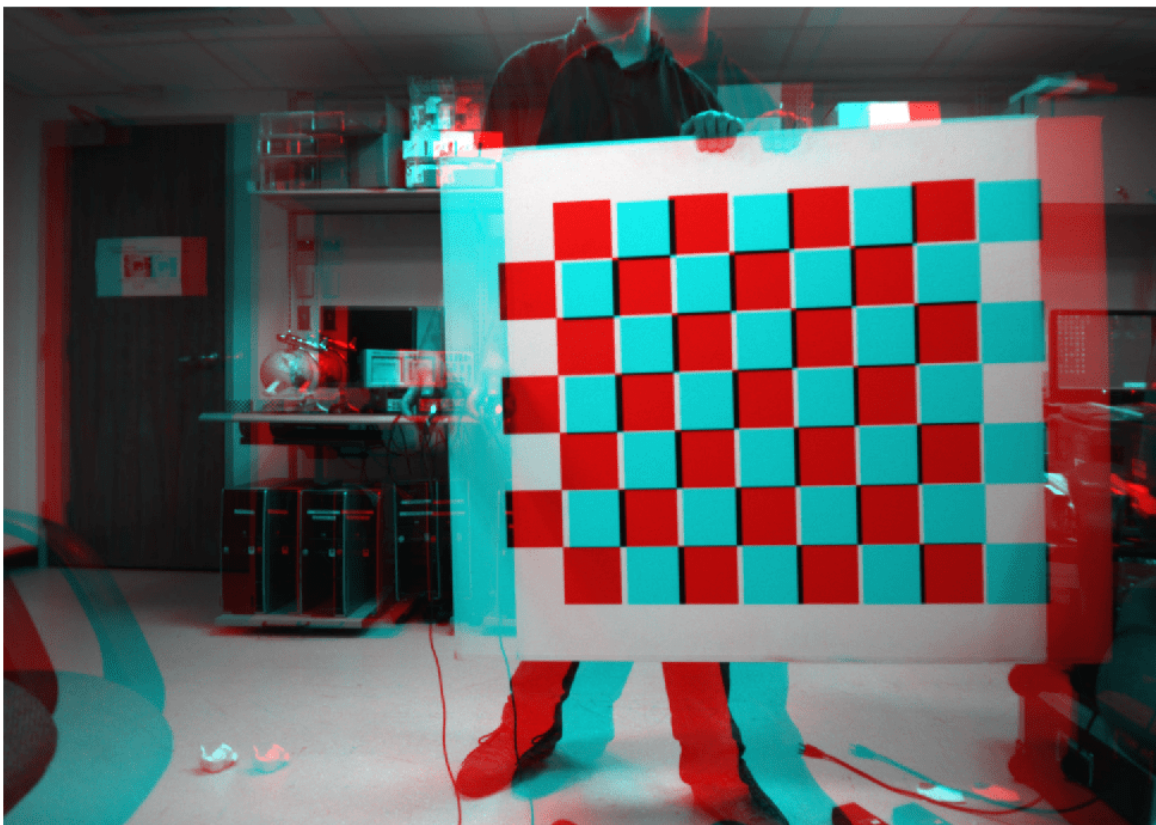

Input Arguments

I1 — Input image 1

M-by-*N*-by-3 truecolor image | *M*-by-*N* 2-D grayscale image

Input image corresponding to camera 1, specified as an *M*-by-*N*-by-3 truecolor image or an *M*-by-*N* 2-D grayscale array. Input images I1 and I2 must also be real, finite, and nonsparse. The input images must be the same class.

Data Types: uint8 | uint16 | int16 | single | double | logical

I2 — Input image 2

M-by-*N*-by-3 truecolor image | *M*-by-*N* 2-D truecolor image

Input image corresponding to camera 2, specified as an M -by- N -by-3 truecolor image or an M -by- N 2-D grayscale array. Input images I1 and I2 must be real, finite, and nonsparse. The input images must also be the same class.

Data Types: `uint8` | `uint16` | `int16` | `single` | `double` | `logical`

stereoParams — Stereo camera system parameters

`stereoParameters` object

Stereo camera system parameters, specified as a `stereoParameters` object.

Data Types: `uint8` | `uint16` | `int16` | `single` | `double`

tform1 — Projective transformation

3-by-3 matrix | `projective2d` object

Projective transformations for image 1, specified as a 3-by-3 matrix returned by the `estimateUncalibratedRectification` function or a `projective2d` object.

tform2 — Projective transformation

3-by-3 matrix | `projective2d` object

Projective transformations for image 2, specified as a 3-by-3 matrix returned by the `estimateUncalibratedRectification` function or a `projective2d` object.

interp — Interpolation method

'linear' (default) | 'nearest' | 'cubic'

Interpolation method, specified as either 'linear', 'nearest', or 'cubic'.

Name-Value Pair Arguments

Specify optional comma-separated pairs of `Name`, `Value` arguments. `Name` is the argument name and `Value` is the corresponding value. `Name` must appear inside quotes. You can specify several name and value pair arguments in any order as `Name1, Value1, ..., NameN, ValueN`.

Example: 'OutputView', 'valid' sets the 'OutputView' property to 'valid'.

OutputView — Size of rectified images

'valid' (default) | 'full'

Size of rectified images, specified as the comma-separated pair consisting of 'OutputView' and either 'full' or 'valid'. When you set this parameter to 'full', the rectified images include all pixels from the original images. When you set this value to 'valid', the output images are cropped to the size of the largest common rectangle containing valid pixels.

When there is no overlap between rectified images, set the `OutputView` to 'full'.

FillValues — Output pixel fill values

array of scalar values

Output pixel fill values, specified as the comma-separated pair consisting of 'FillValues' and an array of one or more scalar values. When the corresponding inverse-transformed location in the input image is completely outside the input image boundaries, use the fill values for output pixels. If I1 and I2 are 2-D grayscale images, then you must set 'FillValues' to a scalar. If I1 and I2 are truecolor images, then you can set 'FillValues' to a scalar or a 3-element vector of RGB values.

Output Arguments

J1 — Undistorted and rectified image 1

M-by-*N*-by-3 truecolor image | *M*-by-*N* 2-D grayscale image

Undistorted and rectified version of I1, returned as an *M*-by-*N*-by-3 truecolor image or as an *M*-by-*N* 2-D grayscale image.

Stereo image rectification projects images onto a common image plane in such a way that the corresponding points have the same row coordinates. This image projection makes the image appear as though the two cameras are parallel. Use the `disparityBM` or `disparitySGM` functions to compute a disparity map from the rectified images for 3-D scene reconstruction.

J2 — Undistorted and rectified image 2

M-by-*N*-by-3 truecolor image | *M*-by-*N* 2-D grayscale image

Undistorted and rectified version of I2, returned as an *M*-by-*N*-by-3 truecolor image or as an *M*-by-*N* 2-D grayscale image.

Stereo image rectification projects images onto a common image plane in such a way that the corresponding points have the same row coordinates. This image projection makes the image appear as though the two cameras are parallel. Use the `disparityBM` or `disparitySGM` functions to compute a disparity map from the rectified images for 3-D scene reconstruction.

Tips

- The Computer Vision Toolbox rectification algorithm requires that the epipole for each image lie outside of the image. If the epipole lies within the image, you can first transform the images into polar coordinates as described in the rectification method proposed by Marc Pollefeys, Reinhard Koch, and Luc Van Gool [2] on page 3-551.

References

- [1] G. Bradski and A. Kaehler, *Learning OpenCV : Computer Vision with the OpenCV Library*. Sebastopol, CA: O'Reilly, 2008.

Extended Capabilities

C/C++ Code Generation

Generate C and C++ code using MATLAB® Coder™.

Usage notes and limitations:

- 'interp' and 'OutputView' must be compile-time constants.
- To generate code, use the `toStruct` function to pass `stereoParameters` to the `rectifyStereoImages` function.

See Also

`reconstructScene` | `disparityBM` | `disparitySGM` | `estimateCameraParameters` | `estimateUncalibratedRectification` | `stereoParameters` | **Camera Calibrator** | **Stereo Camera Calibrator**

Topics

“Structure From Motion From Two Views”

“Structure From Motion From Multiple Views”

“Uncalibrated Stereo Image Rectification”

“Code Generation for Depth Estimation From Stereo Video”

“Coordinate Systems”

Introduced in R2014a

retrieveImages

Search image set for similar image

Syntax

```
imageIDs = retrieveImages(queryImage,imageIndex)
[imageIDs,scores] = retrieveImages(queryImage,imageIndex)
[imageIDs,scores,imageWords] = retrieveImages(queryImage,imageIndex)
[imageIDs, ___ ] = retrieveImages(queryImage,imageIndex,Name,Value)
```

Description

`imageIDs = retrieveImages(queryImage,imageIndex)` returns the image identifiers `imageIDs` that correspond to images within `imageIndex` that are visually similar to the query image. The `imageIDs` are returned in ranked order, from the most to least similar match.

`[imageIDs,scores] = retrieveImages(queryImage,imageIndex)` optionally returns the similarity scores used to rank the image retrieval results. The `scores` output contains the corresponding scores from 0 to 1.

`[imageIDs,scores,imageWords] = retrieveImages(queryImage,imageIndex)` optionally returns the visual words in `queryImage` that are used to search for similar images.

`[imageIDs, ___] = retrieveImages(queryImage,imageIndex,Name,Value)` uses additional options specified by one or more `Name, Value` pair arguments, using any of the preceding syntaxes.

Examples

Search Image Set Using Query Image

Create an image set of book covers.

```
dataDir = fullfile(toolboxdir('vision'),'visiondata','bookCovers');
bookCovers = imageDatastore(dataDir);
```

Display the data set.

```
thumbnailGallery = [];
for i = 1:length(bookCovers.Files)
    I = readimage(bookCovers,i);
    thumbnail = imresize(I,[300 300]);
    thumbnailGallery = cat(4,thumbnailGallery,thumbnail);
end

figure
montage(thumbnailGallery);
```

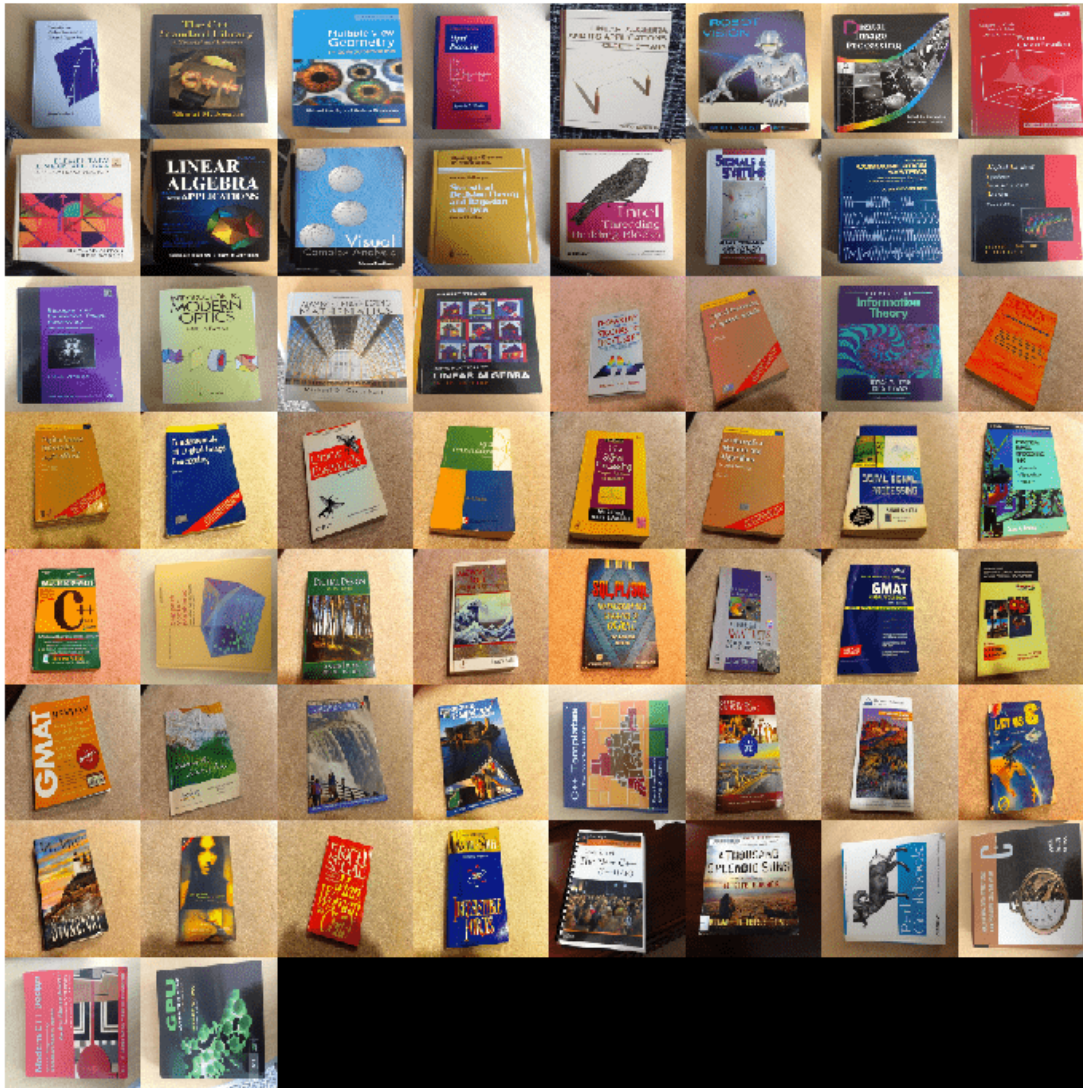
Index the image set. This step may take a few minutes.

```
imageIndex = indexImages(bookCovers);
```

Creating an inverted image index using Bag-Of-Features.

Creating Bag-Of-Features.

- * Selecting feature point locations using the Detector method.
- * Extracting SURF features from the selected feature point locations.
- ** detectSURFFeatures is used to detect key points for feature extraction.

```
* Extracting features from 58 images...done. Extracted 29216 features.
* Keeping 80 percent of the strongest features from each category.
* Balancing the number of features across all image categories to improve clustering.
** Image category 1 has the least number of strongest features: 23373.
** Using the strongest 23373 features from each of the other image categories.

* Creating a 20000 word visual vocabulary.
* Number of levels: 1
* Branching factor: 20000
* Number of clustering steps: 1

* [Step 1/1] Clustering vocabulary level 1.
* Number of features      : 23373
* Number of clusters     : 20000
* Initializing cluster centers...100.00%.
* Clustering...completed 11/100 iterations (~0.86 seconds/iteration)...converged in 11 iterations.

* Finished creating Bag-Of-Features
```

Encoding images using Bag-Of-Features.

```
* Encoding 58 images...done.
Finished creating the image index.
```

Select and display the query image.

```
queryDir = fullfile(dataDir, 'queries', filesep);
queryImage = imread([queryDir 'query3.jpg']);
```

```
imageIDs = retrieveImages(queryImage, imageIndex);
```

Show the query image and its best match, side-by-side.

```
bestMatch = imageIDs(1);
bestImage = imread(imageIndex.ImageLocation{bestMatch});
```

```
figure
imshowpair(queryImage, bestImage, 'montage')
```

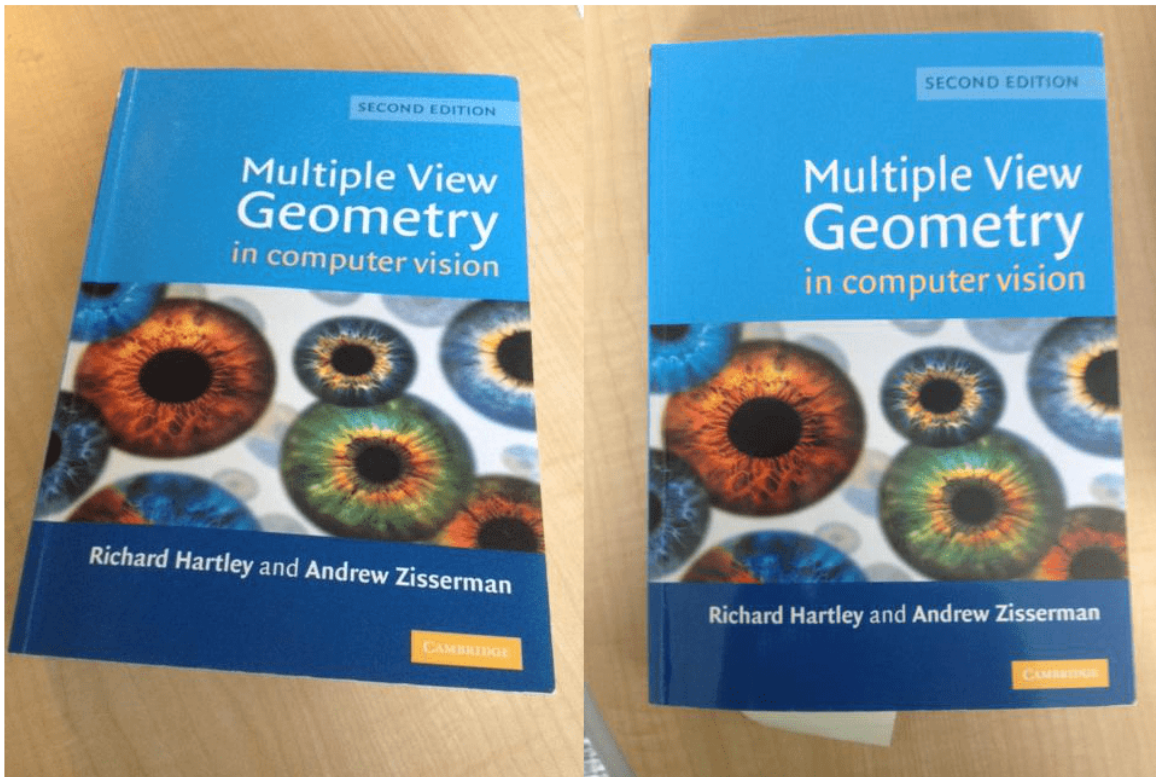

Search Image Set for Specific Object Using ROIs

Search an image set for an object using a region of interest (ROI) for the query image.

Define a set of images to search.

```
imageFiles = ...
    {'elephant.jpg', 'cameraman.tif', ...
     'peppers.png', 'saturn.png', ...
     'pears.png', 'stapleRemover.jpg', ...
     'football.jpg', 'mandi.tif', ...
     'kids.tif', 'liftingbody.png', ...
     'office_5.jpg', 'gantrycrane.png', ...
     'moon.tif', 'circuit.tif', ...
     'tape.png', 'coins.png'};
```

```
imds = imageDatastore(imageFiles);
```

Create a search index.

```
imageIndex = indexImages(imds);
```

Creating an inverted image index using Bag-Of-Features.

Creating Bag-Of-Features.

```
* Selecting feature point locations using the Detector method.
* Extracting SURF features from the selected feature point locations.
** detectSURFFeatures is used to detect key points for feature extraction.

* Extracting features from 16 images...done. Extracted 3680 features.

* Keeping 80 percent of the strongest features from each category.

* Balancing the number of features across all image categories to improve clustering.
** Image category 1 has the least number of strongest features: 2944.
** Using the strongest 2944 features from each of the other image categories.

* Creating a 2944 word visual vocabulary.
* Number of levels: 1
* Branching factor: 2944
* Number of clustering steps: 1

* [Step 1/1] Clustering vocabulary level 1.
* Number of features      : 2944
* Number of clusters     : 2944
* Initializing cluster centers...100.00%.
* Clustering...completed 1/100 iterations (~0.10 seconds/iteration)...converged in 1 iterations.

* Finished creating Bag-Of-Features
```

Encoding images using Bag-Of-Features.

```
* Encoding 16 images...done.
Finished creating the image index.
```

Specify a query image and an ROI. The ROI outlines the object, an elephant, for the search.

```
queryImage = imread('clutteredDesk.jpg');
queryROI = [130 175 330 365];

figure
imshow(queryImage)
rectangle('Position',queryROI,'EdgeColor','yellow')
```



You can also use the `imrect` function to select an ROI interactively. For example, `queryROI = getPosition(imrect)`

Find images that contain the object.

```
imageIDs = retrieveImages(queryImage,imageIndex,'ROI',queryROI)
```

```
imageIDs = 12x1 uint32 column vector
```

```
1
11
6
12
3
14
2
8
10
13
:
```

Display the best match.

```
bestMatch = imageIDs(1);  
  
figure  
imshow(imageIndex.ImageLocation{bestMatch})
```



Geometric Verification Using `estimateGeometricTransform2D` Function

Use the locations of visual words to verify the best search result. To rerank the search results based on geometric information, repeat this procedure for the top N search results.

Specify the location of the images.

```
dataDir = fullfile(toolboxdir('vision'),'visiondata','bookCovers');  
bookCovers = imageDatastore(dataDir);
```

Index the image set. This process can take a few minutes.

```
imageIndex = indexImages(bookCovers);
```

```
Creating an inverted image index using Bag-Of-Features.  
-----
```

```
Creating Bag-Of-Features.  
-----
```

```
* Selecting feature point locations using the Detector method.  
* Extracting SURF features from the selected feature point locations.  
** detectSURFFeatures is used to detect key points for feature extraction.  
  
* Extracting features from 58 images...done. Extracted 29216 features.  
  
* Keeping 80 percent of the strongest features from each category.  
  
* Balancing the number of features across all image categories to improve clustering.  
** Image category 1 has the least number of strongest features: 23373.  
** Using the strongest 23373 features from each of the other image categories.  
  
* Creating a 20000 word visual vocabulary.  
* Number of levels: 1  
* Branching factor: 20000  
* Number of clustering steps: 1  
  
* [Step 1/1] Clustering vocabulary level 1.  
* Number of features      : 23373  
* Number of clusters     : 20000  
* Initializing cluster centers...100.00%.  
* Clustering...completed 11/100 iterations (~1.14 seconds/iteration)...converged in 11 iterations  
  
* Finished creating Bag-Of-Features
```

```
Encoding images using Bag-Of-Features.  
-----
```

```
* Encoding 58 images...done.  
Finished creating the image index.
```

```
Select and display the query image.
```

```
queryDir = fullfile(dataDir,'queries',filesep);  
queryImage = imread([queryDir 'query3.jpg']);
```

```
figure  
imshow(queryImage)
```

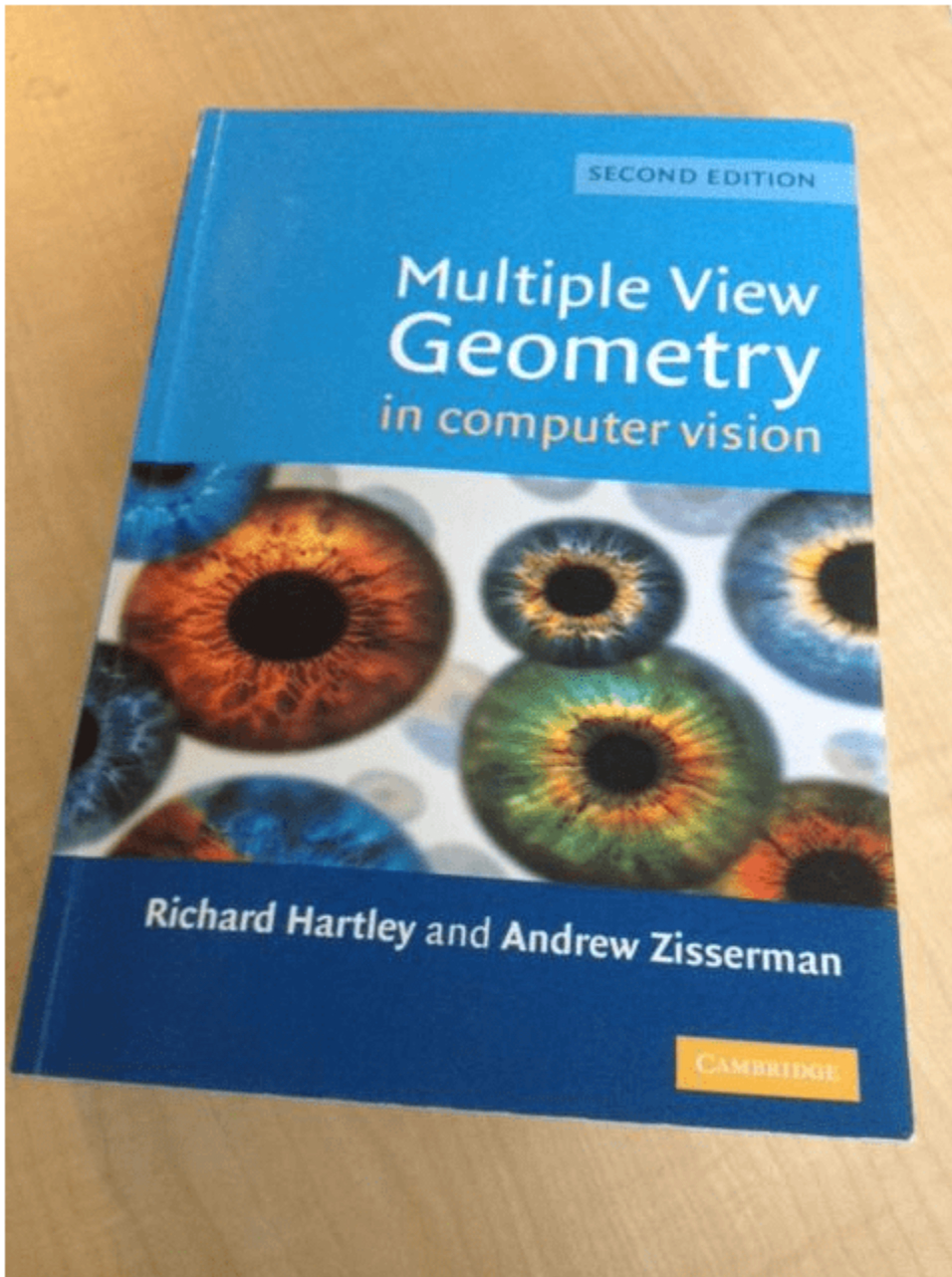

Retrieve the best matches. The `queryWords` output contains visual word locations information for the query image. Use this information to verify the search results.

```
[imageIDs, ~, queryWords] = retrieveImages(queryImage, imageIndex);
```

Find the best match for the query image by extracting the visual words from the image index. The image index contains the visual word information for all images in the index.

```
bestMatch = imageIDs(1);  
bestImage = imread(imageIndex.ImageLocation{bestMatch});  
bestMatchWords = imageIndex.ImageWords(bestMatch);
```

Generate a set of tentative matches based on visual word assignments. Each visual word in the query can have multiple matches due to the hard quantization used to assign visual words.

```
queryWordsIndex = queryWords.WordIndex;  
bestMatchWordIndex = bestMatchWords.WordIndex;  
  
tentativeMatches = [];  
for i = 1:numel(queryWords.WordIndex)  
    idx = find(queryWordsIndex(i) == bestMatchWordIndex);  
    matches = [repmat(i, numel(idx), 1) idx];  
    tentativeMatches = [tentativeMatches; matches];  
  
end
```

Show the point locations for the tentative matches. There are many poor matches.

```
points1 = queryWords.Location(tentativeMatches(:,1),:);  
points2 = bestMatchWords.Location(tentativeMatches(:,2),:);  
  
figure  
showMatchedFeatures(queryImage,bestImage,points1,points2,'montage')
```

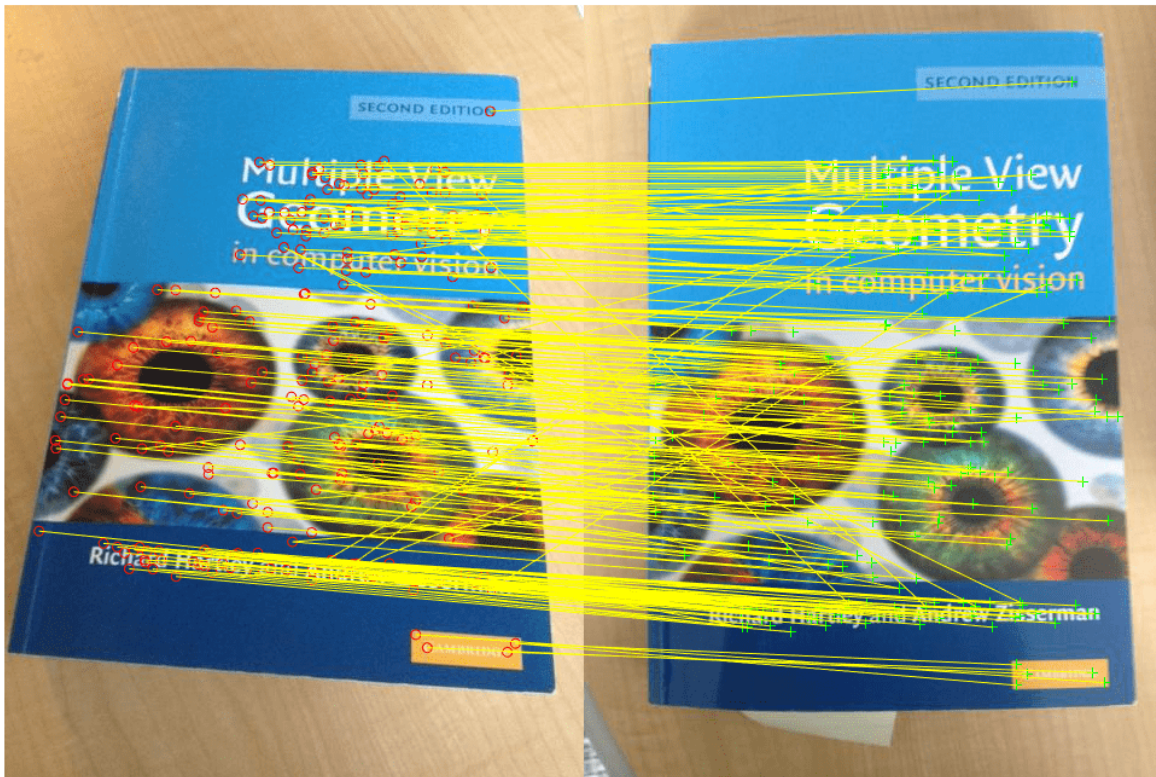

Remove poor visual word assignments using `estimateGeometricTransform2D` function. Keep the assignments that fit a valid geometric transform.

```
[tform,inlierIdx] = ...
    estimateGeometricTransform2D(points1,points2,'affine',...
        'MaxNumTrials',2000);
inlierPoints1 = points1(inlierIdx, :);
inlierPoints2 = points2(inlierIdx, :);
```

Rerank the search results by the percentage of inliers. Do this when the geometric verification procedure is applied to the top N search results. Those images with a higher percentage of inliers are more likely to be relevant.

```
percentageOfInliers = size(inlierPoints1,1)./size(points1,1);
```

```
figure
showMatchedFeatures(queryImage,bestImage,inlierPoints1,...
    inlierPoints2,'montage')
```

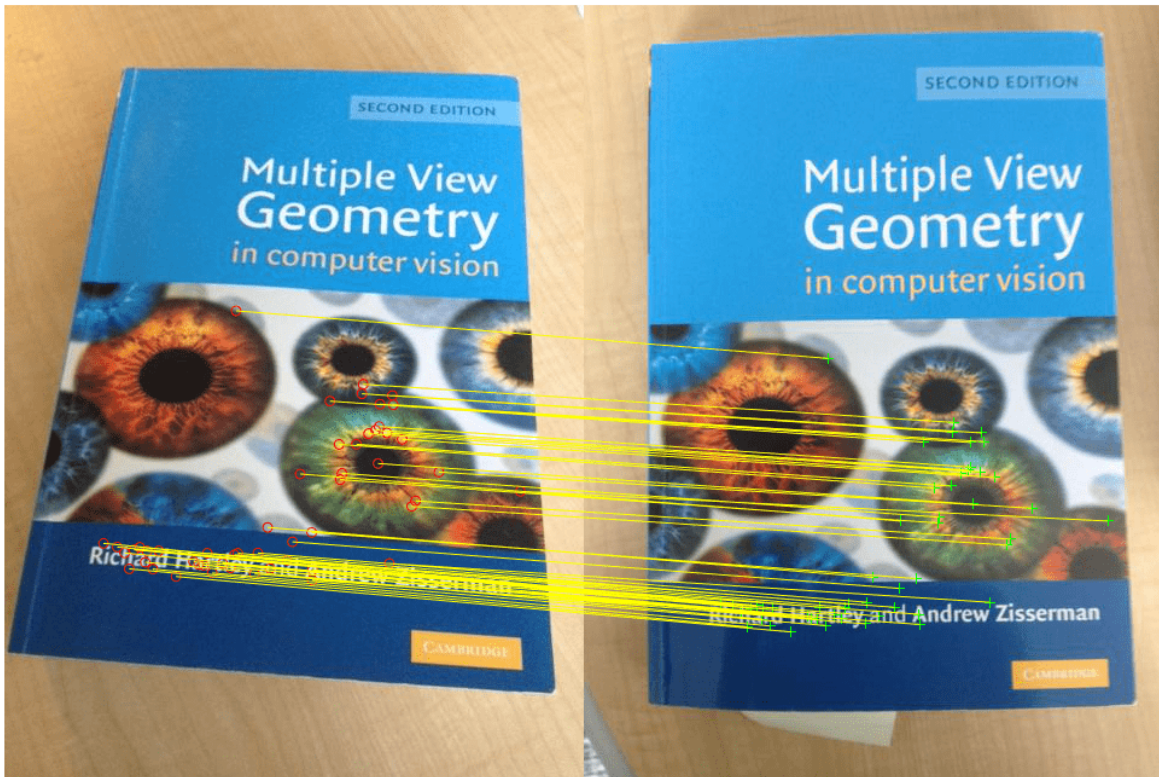

Apply the estimated transform.

```
outputView = imref2d(size(bestImage));  
Ir = imwarp(queryImage, tform, 'OutputView', outputView);  
  
figure  
imshowpair(Ir,bestImage,'montage')
```

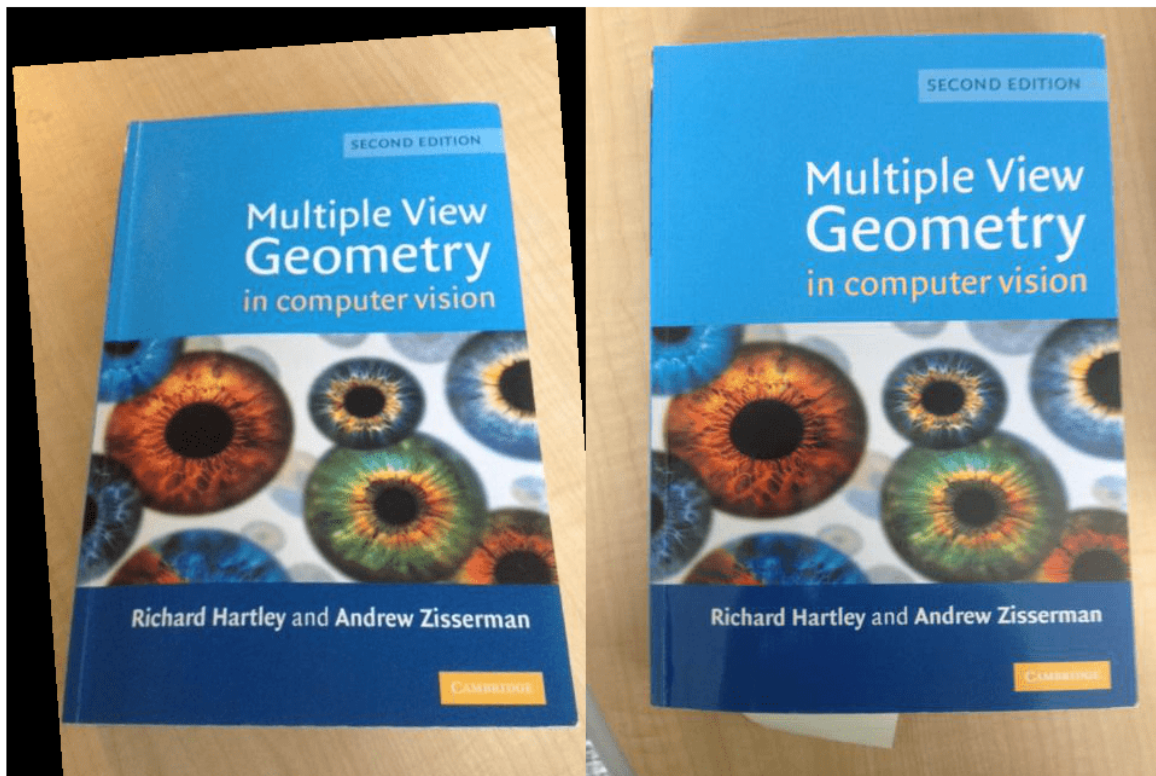
Modify Search Parameters For Image Search

Use the `evaluateImageRetrieval` function to help select proper search parameters.

Create an image set.

```
setDir = fullfile(toolboxdir('vision'),'visiondata','imageSets','cups');
imds = imageDatastore(setDir, 'IncludeSubfolders', true, 'LabelSource', 'foldernames');
```

Index the image set.

```
imageIndex = indexImages(imds, 'Verbose', false);
```

Tune image search parameters.

```
imageIndex.MatchThreshold = 0.2;
imageIndex.WordFrequencyRange = [0 1]
```

```
imageIndex =
    invertedImageIndex with properties:
```

```
    ImageLocation: {6x1 cell}
    ImageWords: [6x1 vision.internal.visualWords]
    WordFrequency: [1x1366 double]
```

```

    BagOfFeatures: [1x1 bagOfFeatures]
        ImageID: [1 2 3 4 5 6]
    MatchThreshold: 0.2000
    WordFrequencyRange: [0 1]

```

```

queryImage = readimage(imds, 1);
indices = retrieveImages(queryImage,imageIndex);

```

Input Arguments

queryImage — Input query image

M-by-*N*-by-3 truecolor image | *M*-by-*N* 2-D grayscale image

Input query image, specified as either an *M*-by-*N*-by-3 truecolor image or an *M*-by-*N* 2-D grayscale image.

Data Types: single | double | int16 | uint8 | uint16 | logical

imageIndex — Image search index

`invertedImageIndex` object

Image search index, specified as an `invertedImageIndex` object. The `indexImages` function creates the `invertedImageIndex` object, which stores the data used for the image search.

Name-Value Pair Arguments

Specify optional comma-separated pairs of `Name`, `Value` arguments. `Name` is the argument name and `Value` is the corresponding value. `Name` must appear inside quotes. You can specify several name and value pair arguments in any order as `Name1, Value1, ..., NameN, ValueN`.

Example: `'NumResults',25` sets the `'NumResults'` property to 25

NumResults — Maximum number of results

20 (default) | numeric value

Maximum number of results to return, specified as the comma-separated pair consisting of `'NumResults'` and a numeric value. Set this value to `Inf` to return as many matching images as possible.

ROI — Query image search region

`[1 1 size(queryImage,2) size(queryImage,1)]` (default) | `[x y width height]` vector

Query image search region, specified as the comma-separated pair consisting of `'ROI'` and an `[x y width height]` vector.

Metric — Similarity metric

`'cosine'` (default) | `'L1'`

Similarity metric used to rank the image retrieval results, specified as `'cosine'` or `'L1'` [3] on page 3-832.

Output Arguments

imageIDs — Ranked index of retrieved images

M-by-1 vector

Ranked index of retrieved images, returned as an *M*-by-1 vector. The image IDs are returned in ranked order, from the most to least similar matched image.

scores — Similarity metric

N-by-1 vector

Similarity metric, returned as an *N*-by-1 vector. This output contains the scores that correspond to the retrieved images in the `imageIDs` output. The scores are computed using the `Metric` property and a range from 0 to 1.

imageWords — Object for storing visual word assignments

`visualWords` object

Object for storing visual word assignments, returned as a `visualWords` object. The object stores the visual word assignments of `queryImage` and their locations within that image.

References

- [1] Sivic, J. and A. Zisserman. *Video Google: A text retrieval approach to object matching in videos*. ICCV (2003) pg 1470-1477.
- [2] Philbin, J., O. Chum, M. Isard, J. Sivic, and A. Zisserman. *Object retrieval with large vocabularies and fast spatial matching*. CVPR (2007).
- [3] Gálvez-López, Dorian, and Juan D. Tardos. *Bags of binary words for fast place recognition in image sequences*. IEEE Transactions on Robotics 28.5 (2012): 1188-1197.

See Also

`evaluateImageRetrieval` | `imageDatastore` | `imageSet` | `bagOfFeatures` | `invertedImageIndex`

Topics

“Image Retrieval Using Customized Bag of Features”
“Image Retrieval with Bag of Visual Words”

Introduced in R2015a

roialign

Non-quantized ROI pooling of `dLarray` data

Syntax

```
dLY = roialign(dLX,boxes,outputSize)
dLY = roialign(dLX,boxes,outputSize,Name=Value)
```

Description

The ROI align operation pools a rectangular ROI into fixed sized bins without quantizing the grid points to the nearest pixel. The function uses bilinear interpolation to infer the value at each grid point.

Given input data of size $[H W C N]$, where C is the number of channels and N is the number of observations, the pooled deep learning data has size $[h w C \text{sum}(M)]$, where h and w are the specified output size. M is a vector of length N and $M(i)$ is the number of ROIs associated with the i -th observation.

Note To perform ROI pooling within a `layerGraph` object or `Layer` array, use `roiAlignLayer`.

This function requires Deep Learning Toolbox.

`dLY = roialign(dLX,boxes,outputSize)` performs a pooling operation along the spatial dimensions of the input `X` for each bounding box in `boxes`. The outputs, `Y`, are of size `outputSize`.

`dLY = roialign(dLX,boxes,outputSize,Name=Value)` specifies additional name-value arguments.

Examples

Perform ROI Pooling

Create a 4-D formatted `dLarray` object that simulates a batch of two RGB images.

```
X = dLarray(rand(10,10,3,2), "SSCB");
```

Specify the position and batch index of one bounding box.

```
startXY = [2 2];
endXY = [4 4];
batchIdx = 1;
rois = [startXY endXY batchIdx]';
```

Perform ROI pooling with an output size of 3-by-3.

```
Y = roialign(X,rois,[3 3])
```

```
Y =  
  3(S) x 3(S) x 3(C) x 1(B) single darray
```

```
(:,:,1) =
```

```
  0.7464    0.3069    0.1780  
  0.9212    0.8491    0.4677  
  0.7303    0.9057    0.3840
```

```
(:,:,2) =
```

```
  0.3024    0.6428    0.6594  
  0.1542    0.0046    0.1228  
  0.6295    0.5182    0.3304
```

```
(:,:,3) =
```

```
  0.4915    0.7590    0.5035  
  0.4574    0.4302    0.5453  
  0.2960    0.2666    0.5389
```

Input Arguments

dLX — Deep learning data to pool

4-D formatted `darray` object

Deep learning data to pool, specified as a 4-D formatted `darray` object with a data format of "SSCB".

boxes — Bounding boxes

5-by-*N* numeric matrix

Bounding boxes, specified as a 5-by-*N* numeric matrix, where *N* is the number of bounding boxes. Each bounding box is formatted as a column vector of the form [*x_start*; *y_start*; *x_end*; *y_end*; *batchIdx*], where:

- *x_start* and *y_start* specify the (x,y) coordinates of the upper-left corner of the rectangle.
- *x_end* and *y_end* specify the (x,y) coordinates of the bottom-right corner of the rectangle.
- *batchIdx* specifies the index of the observation corresponding to the rectangle.

By default, `boxes` are in the same coordinate space and scale as the input deep learning data `dLX`.

outputSize — Pooled output size

vector of two positive integers

Pooled output size, specified as a vector of two positive integers [*h w*], where *h* is the height and *w* is the width.

Name-Value Pair Arguments

Specify optional pairs of arguments as `Name1=Value1, ..., NameN=ValueN`, where `Name` is the argument name and `Value` is the corresponding value. Name-value arguments must appear after other arguments, but the order of the pairs does not matter.

Example: `dLY = roialign(dLX,boxes,outputSize,ROIScale=2)` scales the input ROIs by a factor of 2

ROIScale — Ratio of scale of input feature map to ROI coordinates

1 (default) | numeric scalar

Ratio of the scale of the input feature map to that of the ROI coordinates. This ratio specifies the factor used to scale input ROIs to the input feature map size.

SamplingRatio — Number of samples in each pooled bin

"auto" (default) | row vector of two positive integers

Number of samples in each pooled bin, specified as "auto" or a row vector of two positive integers. The two elements are the number of vertical and horizontal samples, respectively.

If you do not specify the sampling ratio, then the number of vertical samples has the default value `ceil(roiHeight/outputHeight)`. Likewise, the number of horizontal samples has the default value `ceil(roiWidth/outputWidth)`.

Data Types: `double` | `char`

Output Arguments

dLY — Pooled deep learning data

4-D formatted `dLarray` object

Pooled deep learning data, returned as a 4-D formatted `dLarray` object with a data format of "SSCB".

More About

ROI Align

An ROI align operation returns fixed size feature maps for every rectangular ROI within an input `dLarray`. The function first partitions an ROI into fixed sized bins of size `OutputSize` without quantizing the grid points. Each bin is further sampled at `SamplingRatio` locations. The value at each sampled point is inferred using bilinear interpolation. The average of the sampled values is returned as the output value of each pooled bin.

Extended Capabilities

GPU Arrays

Accelerate code by running on a graphics processing unit (GPU) using Parallel Computing Toolbox™.

This function fully supports GPU arrays. For more information, see "Run MATLAB Functions on a GPU" (Parallel Computing Toolbox).

See Also

`dlarray` | `roiAlignLayer` | `trainFastRCNNObjectDetector` |
`trainFasterRCNNObjectDetector`

Topics

“Getting Started with Object Detection Using Deep Learning”

“Getting Started with R-CNN, Fast R-CNN, and Faster R-CNN”

“Deep Learning in MATLAB” (Deep Learning Toolbox)

“List of Functions with dlarray Support” (Deep Learning Toolbox)

Introduced in R2021b

rotationMatrixToVector

Convert 3-D rotation matrix to rotation vector

Syntax

```
rotationVector = rotationMatrixToVector(rotationMatrix)
```

Description

`rotationVector = rotationMatrixToVector(rotationMatrix)` returns an axis-angle rotation vector that corresponds to the input 3-D rotation matrix. The function uses the Rodrigues formula for the conversion.

Examples

Convert Rotation Matrix to Rotation Vector

Create a matrix representing a 90-degree rotation about the Z -axis.

```
rotationMatrix = [0, -1, 0; 1, 0, 0; 0, 0, 1];
```

Find the equivalent rotation vector.

```
rotationVector = rotationMatrixToVector(rotationMatrix)
```

```
rotationVector = 1×3  
    0         0   -1.5708
```

Input Arguments

rotationMatrix — Rotation of camera

3-by-3 matrix

Rotation of camera, specified as a 3-by-3 matrix. You can obtain this matrix by using the `extrinsics` function.

Output Arguments

rotationVector — Rotation vector

three-element vector

Rotation vector, returned as a three-element vector. The vector represents the axis of rotation in 3-D, where the magnitude corresponds to the rotation angle in radians.

Data Types: `single` | `double`

References

[1] Trucco, E., and A. Verri. *Introductory Techniques for 3-D Computer Vision.* Prentice Hall, 1998.

Extended Capabilities

C/C++ Code Generation

Generate C and C++ code using MATLAB® Coder™.

See Also

`relativeCameraPose` | `triangulate` | `rotationVectorToMatrix` | `extrinsics`

Topics

“Evaluating the Accuracy of Single Camera Calibration”

“Structure From Motion From Two Views”

“Structure From Motion From Multiple Views”

Introduced in R2016a

rotationVectorToMatrix

Convert 3-D rotation vector to rotation matrix

Syntax

```
rotationMatrix = rotationVectorToMatrix(rotationVector)
```

Description

`rotationMatrix = rotationVectorToMatrix(rotationVector)` returns a 3-D rotation matrix that corresponds to the input axis-angle rotation vector. The function uses the Rodrigues formula for the computation.

Examples

Convert Rotation Vector to Rotation Matrix

Create a vector representing a 90-degree rotation about the Z -axis.

```
rotationVector = pi/2 * [0, 0, 1];
```

Find the equivalent rotation matrix.

```
rotationMatrix = rotationVectorToMatrix(rotationVector)
```

```
rotationMatrix = 3×3
```

```
    0.0000    1.0000     0
   -1.0000    0.0000     0
         0         0    1.0000
```

Input Arguments

rotationVector — Rotation vector

three-element vector

Rotation vector, specified as a three-element vector. The vector represents the axis of rotation in 3-D, where the magnitude corresponds to the rotation angle in radians.

Data Types: `single` | `double`

Output Arguments

rotationMatrix — Rotation of camera

3-by-3 matrix

Rotation of camera, returned as a 3-by-3 matrix that corresponds to the input axis-angle rotation vector.

References

[1] Trucco, E., and A. Verri. *Introductory Techniques for 3-D Computer Vision.* Prentice Hall, 1998.

Extended Capabilities

C/C++ Code Generation

Generate C and C++ code using MATLAB® Coder™.

See Also

`relativeCameraPose` | `triangulate` | `rotationMatrixToVector` | `extrinsics`

Topics

“Evaluating the Accuracy of Single Camera Calibration”

“Structure From Motion From Two Views”

“Structure From Motion From Multiple Views”

Introduced in R2016a

segmentationConfusionMatrix

Confusion matrix of multi-class pixel-level image segmentation

Syntax

```
confusionMatrix = segmentationConfusionMatrix(LPred,LTruth)
```

Description

`confusionMatrix = segmentationConfusionMatrix(LPred,LTruth)` computes a confusion matrix from the predicted pixel labels `LPred` and ground truth pixel labels `LTruth`.

Examples

Calculate Confusion Matrix from Labeled Images

Load a pretrained network that performs binary segmentation of triangles against a background.

```
load('triangleSegmentationNetwork');
```

The `triangleImages` data set has 100 test images with ground truth labels. Define the location of the data set.

```
dataSetDir = fullfile(toolboxdir('vision'),'visiondata','triangleImages');
```

Get one test image.

```
testImage = imread(fullfile(dataSetDir,'testImages','image_001.jpg'));
```

Get the corresponding ground truth label. The label image is stored as a numeric image, so convert the ground truth label to a categorical image.

```
gtLabel = imread(fullfile(dataSetDir,'testLabels','labeled_image_001.png'));
classNames = ["triangle","background"];
labelIDs = [255 0];
gtLabel = categorical(gtLabel,labelIDs,classNames);
```

Display the ground truth labels over the test image.

```
imshow(labeloverlay(testImage,gtLabel))
```



Perform semantic image segmentation.

```
predLabel = semanticseg(testImage,net);
```

Get the confusion matrix of the predicted labels and ground truth labels. The confusion matrix shows the segmentation correctly classified 21 pixels as triangle and 939 pixels as background. The confusion matrix also shows that the segmentation misclassified 64 background pixels as triangle. No triangle pixels are misclassified as background.

```
confusionMatrix = segmentationConfusionMatrix(predLabel,gtLabel)
```

```
confusionMatrix = 2×2
```

```
    21    0
    64   939
```

To check the accuracy of the confusion matrix, display the predicted labels over the test image. The overlay agrees with the values in the confusion matrix.

```
imshow(labeloverlay(testImage,predLabel))
```



Input Arguments

LPred — Predicted pixel labels

2-D label image | 3-D label image

Predicted pixel labels after semantic segmentation, specified as a 2-D label image or 3-D label image.

Data Types: `double` | `logical` | `categorical`

LTruth — Ground truth pixel labels

2-D label image | 3-D label image

Ground truth pixel labels, specified as a 2-D label image or 3-D label image of the same size as the predicted pixel labels, LPred.

Data Types: `double` | `logical` | `categorical`

Output Arguments

confusionMatrix — Confusion matrix

C-by-*C* numeric matrix

Confusion matrix for the classes in the segmented images, returned as a *C*-by-*C* numeric matrix, where *C* is the number of classes in the semantic segmentation. Element (*i,j*) is the count of pixels known to belong to class *i* but predicted to belong to class *j*.

Tips

- You can calculate semantic segmentation metrics such as the Jaccard score and classification accuracy from the confusion matrix by using the `evaluateSemanticSegmentation` function.
- You can use this function in block-based image processing workflows such as `bigimage`. For example, you can perform semantic segmentation and calculate the confusion matrix for a block in the same call to the `apply` function.

See Also

`semanticseg` | `dice` | `jaccard` | `semanticSegmentationMetrics` | `evaluateSemanticSegmentation` | `plotconfusion`

Topics

“Calculate Segmentation Metrics in Block-Based Workflow”

“Getting Started with Semantic Segmentation Using Deep Learning”

Introduced in R2020b

segmentLidarData

Segment organized 3-D range data into clusters

Syntax

```
labels = segmentLidarData(ptCloud,distThreshold)
labels = segmentLidarData(ptCloud,distThreshold,angleThreshold)
[labels,numClusters] = segmentLidarData( ___ )
[ ___ ] = segmentLidarData( ___ ,NumClusterPoints=[1,Inf])
```

Description

`labels = segmentLidarData(ptCloud,distThreshold)` segments organized 3-D range data `ptCloud` into clusters. The function assigns an integer cluster label to each point in the point cloud and returns the cluster label of all points in `labels`.

The function groups two neighboring points into the same cluster if their Euclidean distance is less than `distThreshold` or if the angle between the sensor and two neighboring points is at least 5 degrees.

`labels = segmentLidarData(ptCloud,distThreshold,angleThreshold)` sets the angle constraint for grouping points into the same cluster to `angleThreshold`.

`[labels,numClusters] = segmentLidarData(___)` also returns the number of clusters.

`[___] = segmentLidarData(___ ,NumClusterPoints=[1,Inf])` also sets the minimum and maximum number of points in each cluster, specified as a 2-element vector or as a scalar value. When you specify `NumClusterPoints` as a scalar, the maximum number of points in the cluster is unrestricted. The function sets the `labels` to 0 when clusters are outside of the specified range.

Examples

Cluster Organized Synthetic Lidar Data

Create organized synthetic lidar data containing two objects.

```
ldr = zeros(5,100);
ldr(:,1:50) = 10;
ldr(:,51:end) = 20;
pitch = linspace(-18,18,5);
pitch = repmat(pitch',1,100);
yaw = linspace(-90,90,100);
yaw = repmat(yaw,5,1);
```

Convert to Cartesian coordinates.

```
X = ldr .* cosd(pitch) .* sind(yaw);
Y = ldr .* cosd(pitch) .* cosd(yaw);
Z = ldr .* sind(pitch);
pc = pointCloud(cat(3,X,Y,Z));
```

```
figure
pcshow(pc.Location,'r')
title('Unclustered Point Cloud')
```

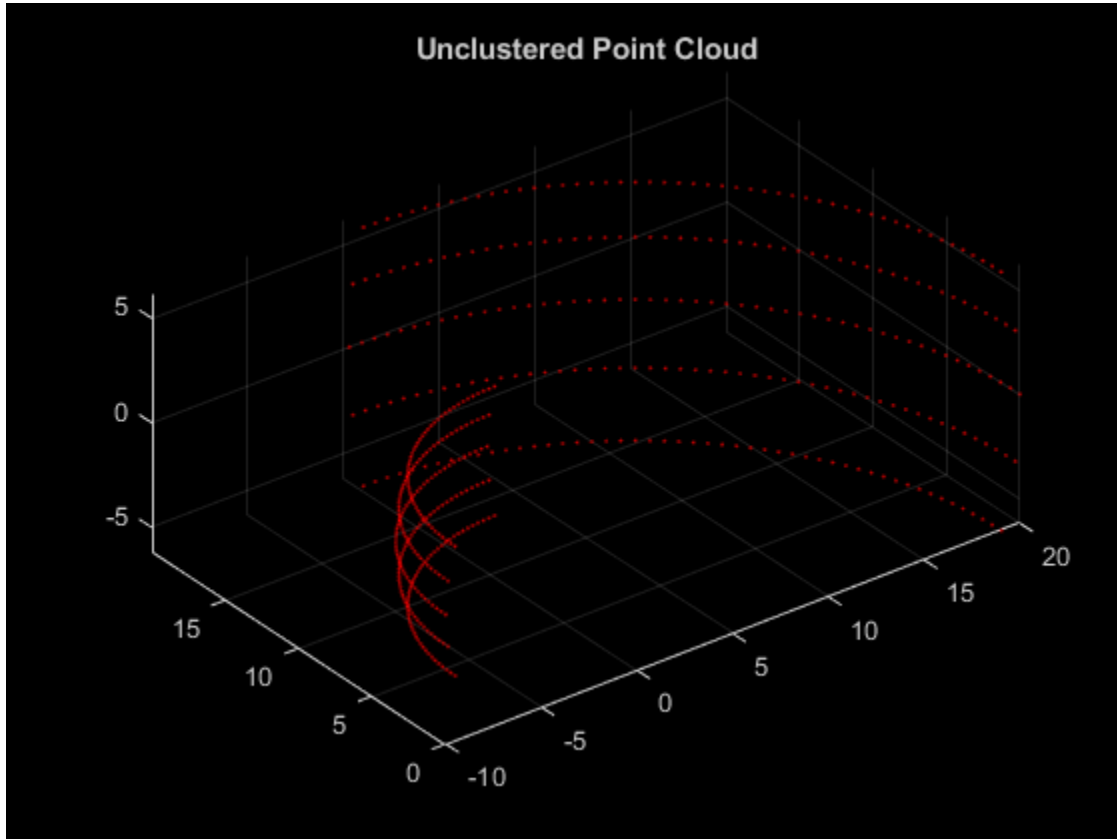

Set the threshold.

```
distThreshold = 5;
```

Segment the lidar data.

```
labels = segmentLidarData(pc,distThreshold);
```

Plot the results.

```
figure
hold on
title('Segmented Clusters')

pc1 = select(pc,find(labels == 1));
pcshow(pc1.Location,'g')

pc2 = select(pc,find(labels == 2));
pcshow(pc2.Location,'y')
```

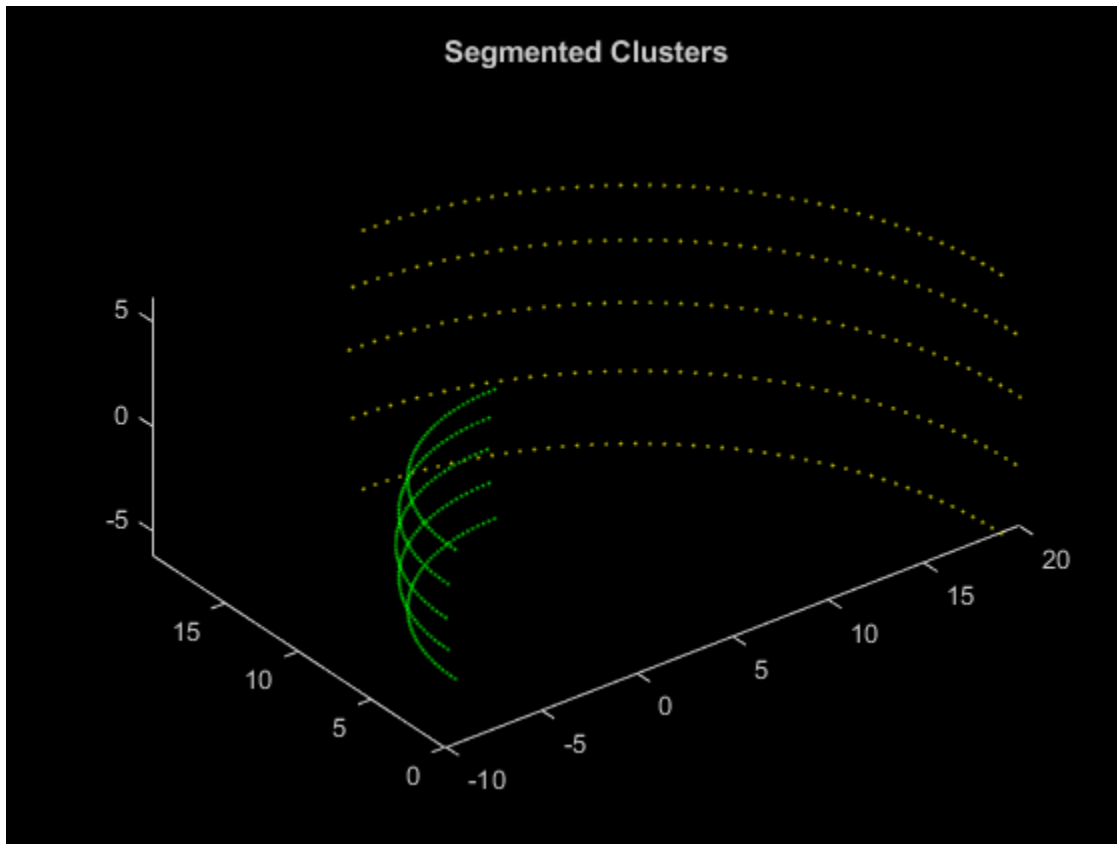

Cluster Organized Lidar Point Cloud

Set up the PCAP file reader.

```
veloReader = velodyneFileReader('lidarData_ConstructionRoad.pcap', 'HDL32E');
```

Wait for 0.3 seconds from the beginning of the file, then read the point cloud from the next frame.

```
veloReader.CurrentTime = veloReader.StartTime + seconds(0.3);
ptCloud = readFrame(veloReader);
```

Segment and remove the ground plane.

```
groundPtsIdx = segmentGroundFromLidarData(ptCloud);
ptCloudWithoutGround = select(ptCloud, ~groundPtsIdx, 'OutputSize', 'full');
```

Cluster the remaining points. Distance is in meters.

```
distThreshold = 0.5;
[labels, numClusters] = segmentLidarData(ptCloudWithoutGround, distThreshold);
```

Add an additional label for the ground plane.

```
numClusters = numClusters+1;
labels(groundPtsIdx) = numClusters;
```

Plot the labeled results. Display the ground plane in black.

```
labelColorIndex = labels+1;
pcshow(ptCloud.Location, labelColorIndex)
colormap([hsv(numClusters);[0 0 0]])
title('Point Cloud Clusters')
```

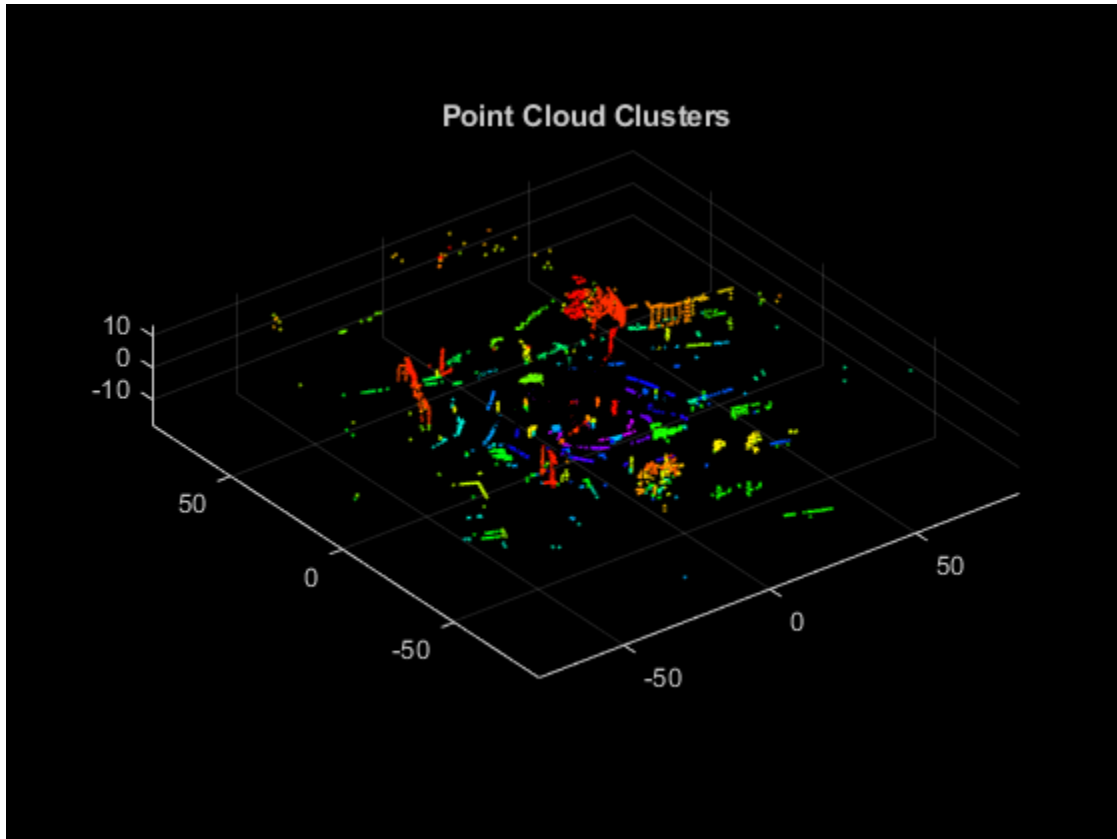

Input Arguments

ptCloud — Point cloud

pointCloud object

Point cloud, specified as a `pointCloud` object. `ptCloud` is an organized point cloud that stores point coordinates in an M -by- N -by-3 matrix. The points must be organized by pitch and yaw angles in a sequential scanning order, which is typically obtained from laser range finders and the `velodyneFileReader`.

distThreshold — Distance threshold

nonnegative scalar

Distance threshold in world units, specified as a nonnegative scalar. Adjacent points are grouped into the same cluster if the distance between them is less than the distance threshold. To reduce the number of output clusters, increase the value of `distThreshold`.

Data Types: `single` | `double`

angleThreshold – Angle threshold

scalar in the range [0, 180]

Angle threshold, in degrees, specified as a scalar in the range [0, 180]. To reduce the number of output clusters, decrease the value of `angleThreshold`. The function groups adjacent points into the same cluster if the angle formed by the sensor and the points is greater than the angle threshold. For example, in the figure, the function groups points A and B into the same cluster if the angle formed by the sensor, point A, and point B, is greater than `angleThreshold`. For more details, see “Algorithms” on page 3-849.

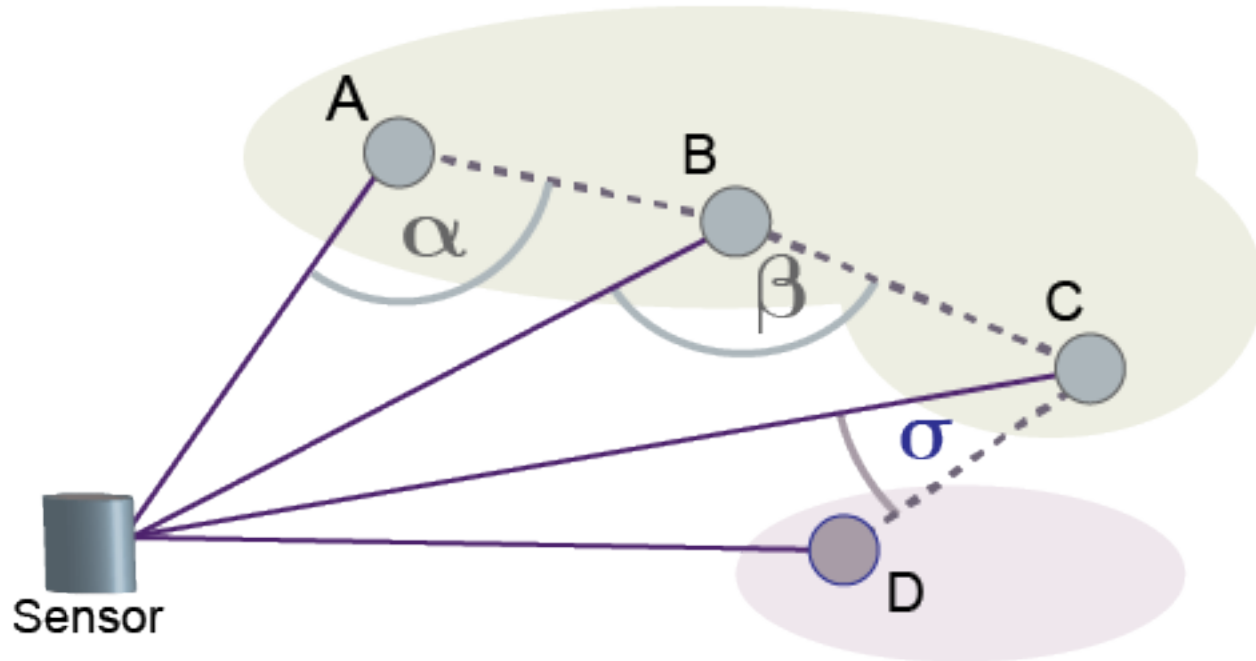

Data Types: single | double

Output Arguments**labels – Cluster labels**

M -by- N matrix

Cluster labels of all points in the point cloud `ptCloud`, returned as an M -by- N matrix of integers. Each valid point in `ptCloud` belongs to a cluster. All points in a cluster are assigned the same integer cluster label, ranging from 1 to `numClusters`. Invalid points, such as points with `Inf` or `NaN` coordinates, are assigned the label 0.

numClusters – Number of clusters

nonnegative integer

Number of clusters, returned as a positive integer. The number of clusters does not include the cluster corresponding to invalid points and excludes the label value, 0, which is reserved for invalid points.

Algorithms

The `segmentLidarData` function uses distance and angle thresholds to cluster neighboring points. The function groups two neighboring points into the same cluster if their Euclidean distance is less than the input `distThreshold` or if the angle between the sensor and neighboring points is greater than or equal to the input `angleThreshold`. If you do not specify `angleThreshold`, the function sets this angle to 5 degrees.

For example, suppose `angleThreshold` is set to 90. Because angles α and β in the figure are both greater than the specified threshold of 90 degrees, the function groups points A, B, and C into the same cluster. Because angle σ is less than the 90-degree threshold, the function groups point D into a separate cluster. Each angle the function uses for clustering is formed by the line from a point to the sensor and the line from that same point to the neighboring point.

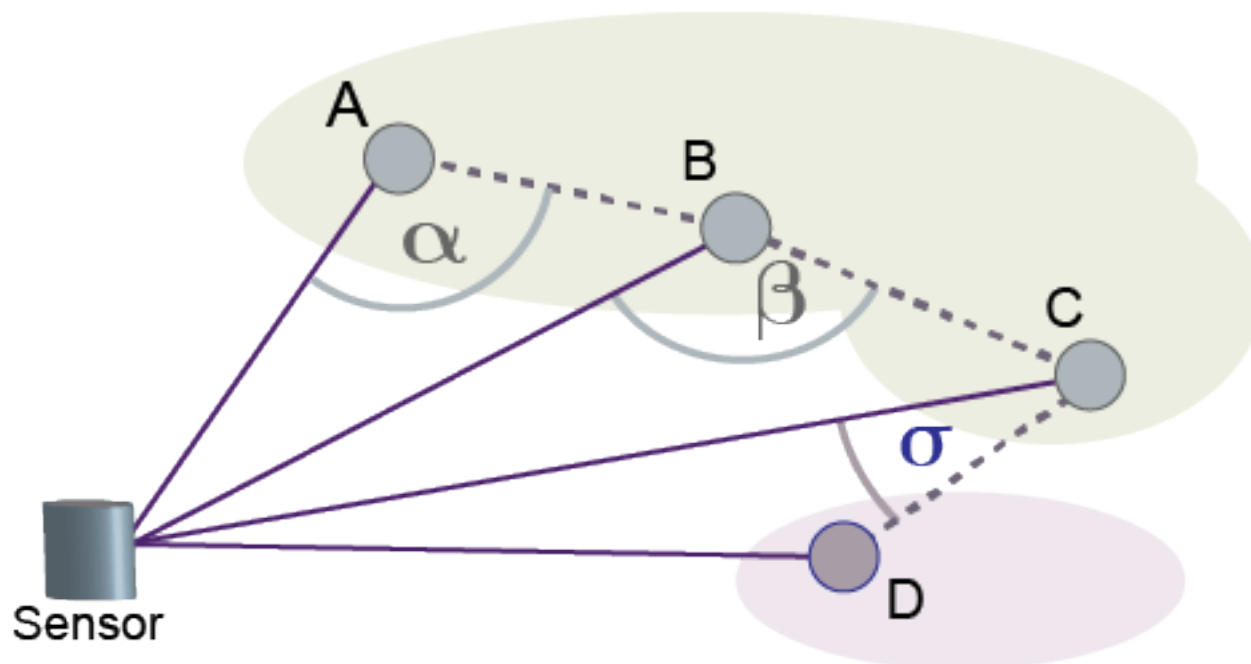

References

- [1] Bogoslavskyi, I. "Efficient Online Segmentation for Sparse 3D Laser Scans." *Journal of Photogrammetry, Remote Sensing and Geoinformation Science*. Vol. 85, Issue 1, 2017, pp. 41-52.

Extended Capabilities

C/C++ Code Generation

Generate C and C++ code using MATLAB® Coder™.

See Also

`pointCloud` | `pcsegdist` | `pcfitplane` | `velodyneFileReader` |
`segmentGroundFromLidarData`

Introduced in R2018a

selectStrongestBbox

Select strongest bounding boxes from overlapping clusters

Syntax

```
[selectedBbox,selectedScore] = selectStrongestBbox(bbox,score)
[selectedBbox,selectedScore,index] = selectStrongestBbox(bbox,score)
[ ___ ] = selectStrongestBbox( ___ ,Name,Value)
```

Description

[selectedBbox,selectedScore] = selectStrongestBbox(bbox,score) returns selected bounding boxes that have a high confidence score. The function uses nonmaximal suppression to eliminate overlapping bounding boxes from the bbox input.

[selectedBbox,selectedScore,index] = selectStrongestBbox(bbox,score) additionally returns the index vector associated with selectedBbox. This vector contains the indices of the selected boxes in the bbox input.

[___] = selectStrongestBbox(___ ,Name,Value) uses additional options specified by one or more Name, Value pair arguments.

Examples

Run Nonmaximal Suppression on Bounding Boxes Using People Detector

Load the pretrained aggregate channel features (ACF) people detector.

```
peopleDetector = peopleDetectorACF();
```

Detect people in an image. Disable the default nonmaximal suppression used by the detector.

```
I = imread('visionteam1.jpg');
[bbox,score] = detect(peopleDetector,I,'SelectStrongest',false);
```

Run nonmaximal suppression with custom threshold.

```
I = imread('visionteam1.jpg');
[selectedBbox,selectedScore] = selectStrongestBbox(bbox,score,'OverlapThreshold',0.3);
```

Display the results.

```
I1 = insertObjectAnnotation(I,'rectangle',bbox,score,'Color','r');
I2 = insertObjectAnnotation(I,'rectangle',selectedBbox,selectedScore,'Color','r');
```

```
figure, imshow(I1);
title('Detected people and detection scores before suppression');
```



```
figure, imshow(I2);
title('Detected people and detection scores after suppression');
```

Detected people and detection scores after suppression

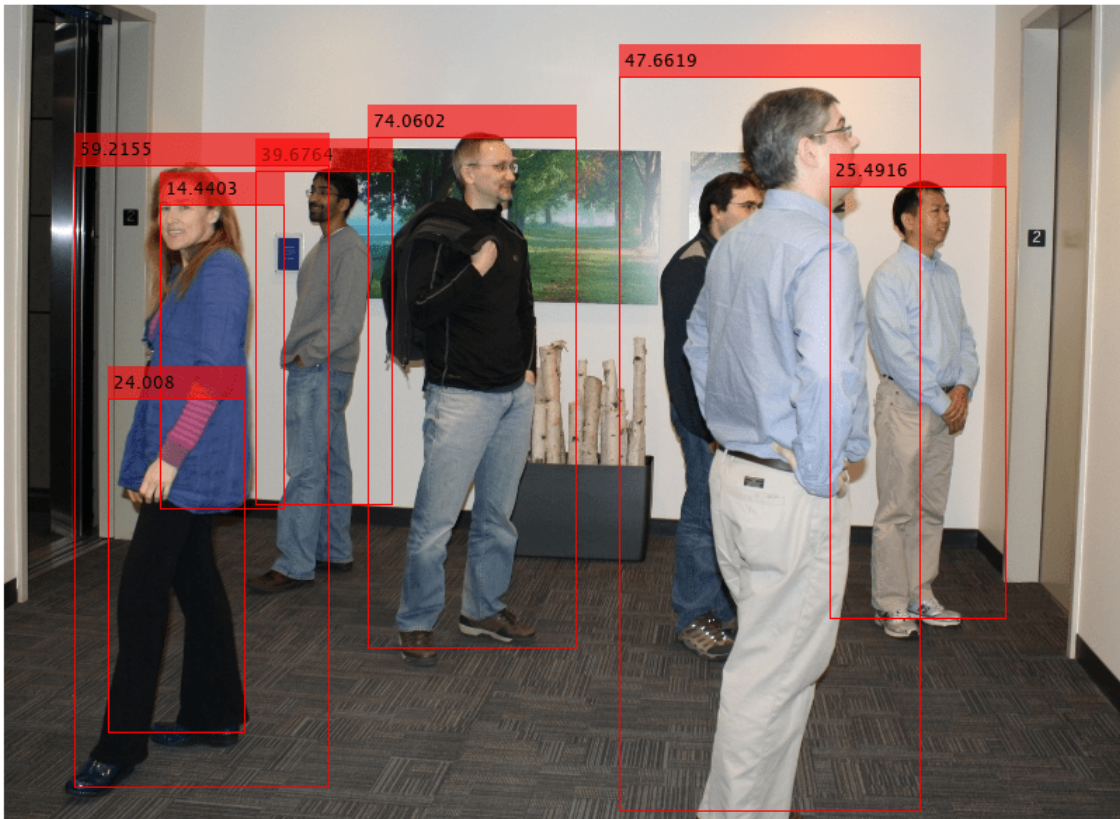

Input Arguments

bbox — Bounding boxes

M-by-4 matrix | *M*-by-5 matrix

Bounding boxes, specified as an *M*-by-4 or *M*-by-5 nonsparse numeric matrix. *M* is the number of bounding boxes. Each row of the matrix defines a bounding box as either an axis-aligned rectangle or a rotated rectangle. This table describes the format for each bounding box.

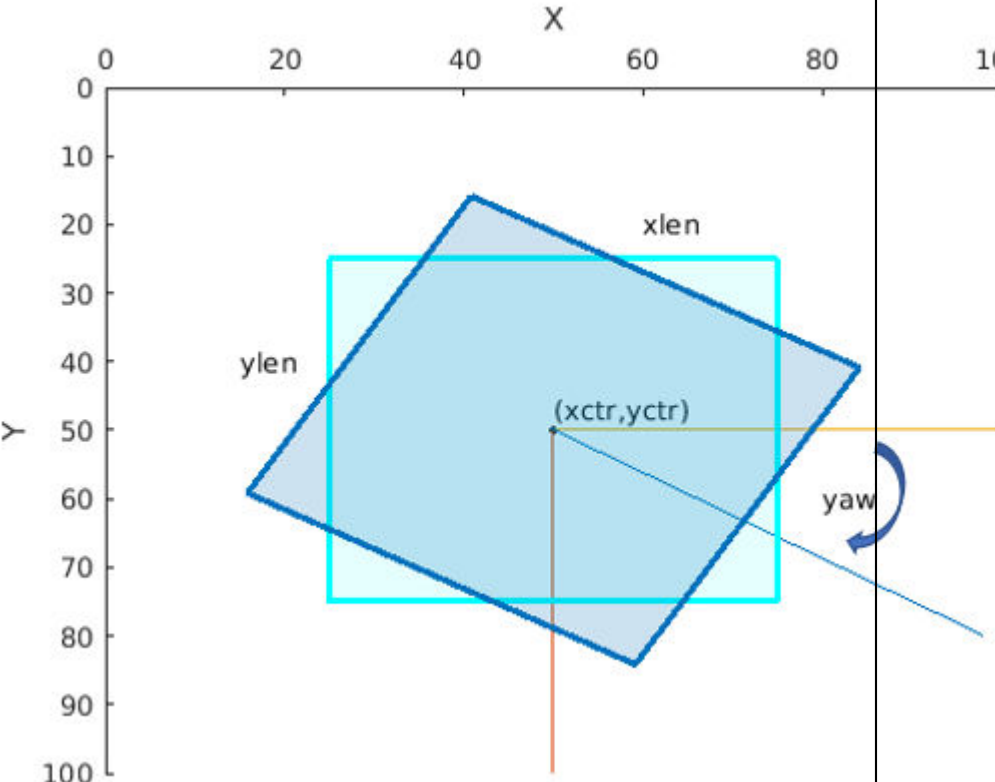
Bounding Box	Description
Axis-aligned rectangle	<p>Defined in pixel coordinates as an M-by-4 numeric matrix with rows of the form $[x\ y\ w\ h]$, where:</p> <ul style="list-style-type: none"> • M is the number of axis-aligned rectangles. • x and y specify the upper-left corner of the rectangle. • w specifies the width of the rectangle, which is its length along the x-axis. • h specifies the height of the rectangle, which is its length along the y-axis.
Rotated rectangle	<p>Defined in spatial coordinates as an M-by-5 numeric matrix with rows of the form $[xctr\ yctr\ xlen\ ylen\ yaw]$, where:</p> <ul style="list-style-type: none"> • M is the number of rotated rectangles. • $xctr$ and $yctr$ specify the center of the rectangle. • $xlen$ specifies the width of the rectangle, which is its length along the x-axis before rotation. • $ylen$ specifies the height of the rectangle, which is its length along the y-axis before rotation. • yaw specifies the rotation angle in degrees. The rotation is clockwise-positive around the center of the bounding box. 

Data Types: `single` | `double` | `int8` | `int16` | `int32` | `uint8` | `uint16` | `uint32`

score — Confidence score

M-by-1 vector

Confidence score, specified as an *M*-by-1 vector. The *M*th score corresponds to the *M*th bounding box in the `bbox` input. The `selectStrongestBbox` function uses nonmaximal suppression to eliminate overlapping bounding boxes and associate the confidence score with the boxes. A higher score represents a higher confidence in keeping the bounding box. The `score` input must be real, finite, and nonsparse.

Data Types: `single` | `double` | `int8` | `int16` | `int32` | `uint8` | `uint16` | `uint32`

Name-Value Pair Arguments

Specify optional comma-separated pairs of `Name`, `Value` arguments. `Name` is the argument name and `Value` is the corresponding value. `Name` must appear inside quotes. You can specify several name and value pair arguments in any order as `Name1, Value1, ..., NameN, ValueN`.

Example: `'RatioType', 'Union'` sets the `'RatioType'` property to `'Union'`.

RatioType — Bounding box overlap ratio denominator

`'Union'` (default) | `'Min'`

Ratio type, specified as the character vector `'Union'` or `'Min'`.

- Set the ratio type to `'Union'` to compute the ratio as the area of intersection between `bboxA` and `bboxB`, divided by the area of the union of the two.
- Set the ratio type to `'Min'` to compute the ratio as the area of intersection between `bboxA` and `bboxB`, divided by the minimum area of the two bounding boxes.

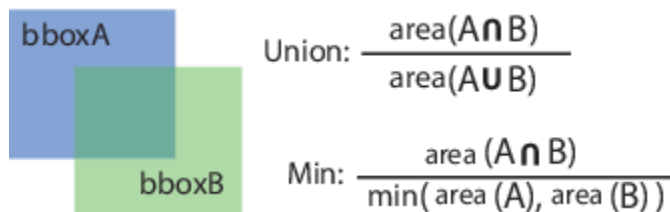

Data Types: `char`

OverlapThreshold — Overlap ratio threshold

0.5 (default) | scalar in the range [0 1]

Overlap ratio threshold, specified as the comma-separated pair consisting of `'OverlapThreshold'` and a scalar in the range [0 1]. When the overlap ratio is above the threshold you set, the function removes bounding boxes around the reference box. Decrease this value to reduce the number of selected bounding boxes. However, if you decrease the overlap ratio too much, you might eliminate boxes that represent objects close to each other in the image.

Data Types: `single` | `double`

NumStrongest — Maximum number of strongest boxes

`inf` (default) | positive scalar

Maximum number of strongest boxes, specified as the comma-separated pair consisting of `'NumStrongest'` and `inf` or a positive scalar. Use this argument to reduce processing time when

you have a priori knowledge about the maximum number of boxes. Set the value to `inf` to select all the strongest, non-overlapping, bounding boxes.

Output Arguments

selectedBbox — Selected bounding boxes

M-by-4 matrix | *M*-by-5 matrix

Selected bounding boxes, returned as an *M*-by-4 or an *M*-by-5 matrix. The 4-element vectors represent axis-aligned rectangles and the 5-element vectors represent rotated rectangles.

The `selectedBbox` output returns the selected bounding boxes from the `bbox` input that have the highest confidence score. The function uses nonmaximal suppression to eliminate overlapping bounding boxes.

Data Types: `single` | `double` | `int8` | `int16` | `int32` | `uint8` | `uint16` | `uint32`

selectedScore — Scores of selected bounding boxes

M-by-1 vector

Scores of selected bounding boxes, returned as an *M*-by-1 vector. The *M*th score in the `selectedScore` output corresponds to the *M*th bounding box in the `selectedBbox` output.

Data Types: `single` | `double` | `int8` | `int16` | `int32` | `uint8` | `uint16` | `uint32`

index — Index of selected bounding boxes

M-by-1 vector

Index of selected bounding boxes, returned as an *M*-by-1 vector. The `index` vector contains the indices to the selected boxes in the `bbox` input.

Data Types: `double`

Extended Capabilities

C/C++ Code Generation

Generate C and C++ code using MATLAB® Coder™.

Usage notes and limitations:

- Code generation is only supported for numeric `labels`.
- Code generation is not supported for rotated rectangle bounding box inputs.

GPU Code Generation

Generate CUDA® code for NVIDIA® GPUs using GPU Coder™.

Usage notes and limitations:

- CUDA code generation is only supported for numeric `labels`.
- CUDA code generation is not supported for rotated rectangle bounding box inputs.

GPU Arrays

Accelerate code by running on a graphics processing unit (GPU) using Parallel Computing Toolbox™.

Usage notes and limitations:

- GPU Arrays is not supported for rotated rectangle bounding box inputs.

See Also

`bboxOverlapRatio` | `selectStrongestBboxMulticlass`

Introduced in R2014b

selectStrongestBboxMulticlass

Select strongest multiclass bounding boxes from overlapping clusters

Syntax

```
selectedBboxes = selectStrongestBboxMulticlass(bboxes,scores,labels)
[selectedBboxes,selectedScores,selectedLabels,index] =
selectStrongestBboxMulticlass(bboxes,scores,labels)
[___] = selectStrongestBboxMulticlass( ___,Name,Value)
```

Description

`selectedBboxes = selectStrongestBboxMulticlass(bboxes,scores,labels)` returns selected bounding boxes that have high confidence scores. The function uses greedy nonmaximal suppression (NMS) to eliminate overlapping bounding boxes from the `bboxes` input, only if they have the same class label.

`[selectedBboxes,selectedScores,selectedLabels,index] = selectStrongestBboxMulticlass(bboxes,scores,labels)` additionally returns the scores, labels, and index associated with the selected bounding boxes.

`[___] = selectStrongestBboxMulticlass(___,Name,Value)` uses additional options specified by one or more `Name,Value` pair arguments.

Examples

Run Multiclass Nonmaximal Suppression on Bounding Boxes Using People Detector

Create detectors using two different models. These will be used to generate multiclass detection results.

```
detectorInria = peopleDetectorACF('inria-100x41');
detectorCaltech = peopleDetectorACF('caltech-50x21');
```

Apply the detectors.

```
I = imread('visionteam1.jpg');
[bboxesInria,scoresInria] = detect(detectorInria,I,'SelectStrongest',false);
[bboxesCaltech,scoresCaltech] = detect(detectorCaltech,I,'SelectStrongest',false);
```

Create categorical labels for each the result of each detector.

```
labelsInria = repelem("inria",numel(scoresInria),1);
labelsInria = categorical(labelsInria,{'inria','caltech'});
labelsCaltech = repelem("caltech",numel(scoresCaltech),1);
labelsCaltech = categorical(labelsCaltech,{'inria','caltech'});
```

Combine results from all detectors to for multiclass detection results.



```
allBBoxes = [bboxesInria;bboxesCaltech];
allScores = [scoresInria;scoresCaltech];
allLabels = [labelsInria;labelsCaltech];
```

Run multiclass non-maximal suppression.

```
[bboxes,scores,labels] = selectStrongestBboxMulticlass(allBBoxes,allScores,allLabels,...
    'RatioType','Min','OverlapThreshold',0.65);
```

Annotate detected people.

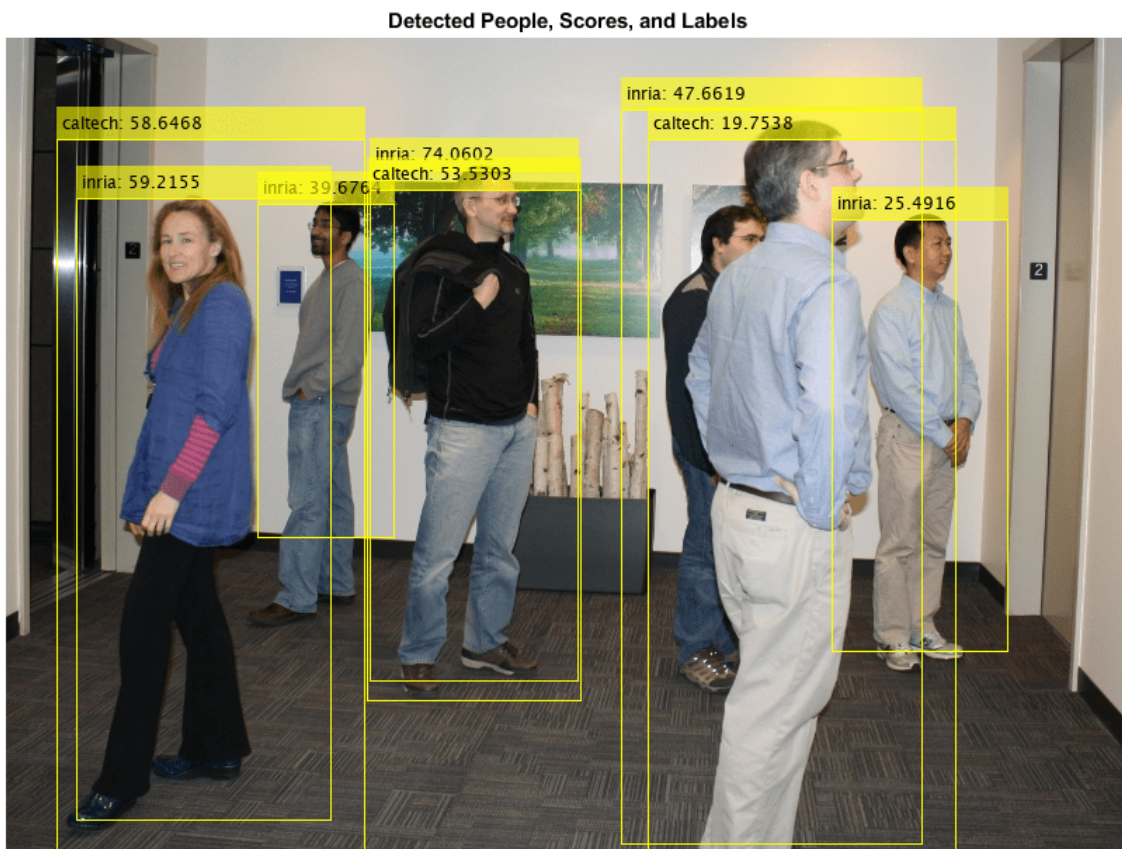
```
annotations = string(labels) + ": " + string(scores);
I = insertObjectAnnotation(I,'rectangle',bboxes,cellstr(annotations));
imshow(I)
title('Detected People, Scores, and Labels')
```



Input Arguments

bboxes — Bounding boxes

M-by-4 matrix | *M*-by-5 matrix

Bounding boxes, specified as an M -by-4 or M -by-5 nonsparse numeric matrix. M is the number of bounding boxes. Each row of the matrix defines a bounding box as either an axis-aligned rectangle or a rotated rectangle. This table describes the format for each bounding box.

Bounding Box	Description
Axis-aligned rectangle	Defined in pixel coordinates as an M -by-4 numeric matrix with rows of the form $[x \ y \ w \ h]$, where: <ul style="list-style-type: none">• M is the number of axis-aligned rectangles.• x and y specify the upper-left corner of the rectangle.• w specifies the width of the rectangle, which is its length along the x-axis.• h specifies the height of the rectangle, which is its length along the y-axis.

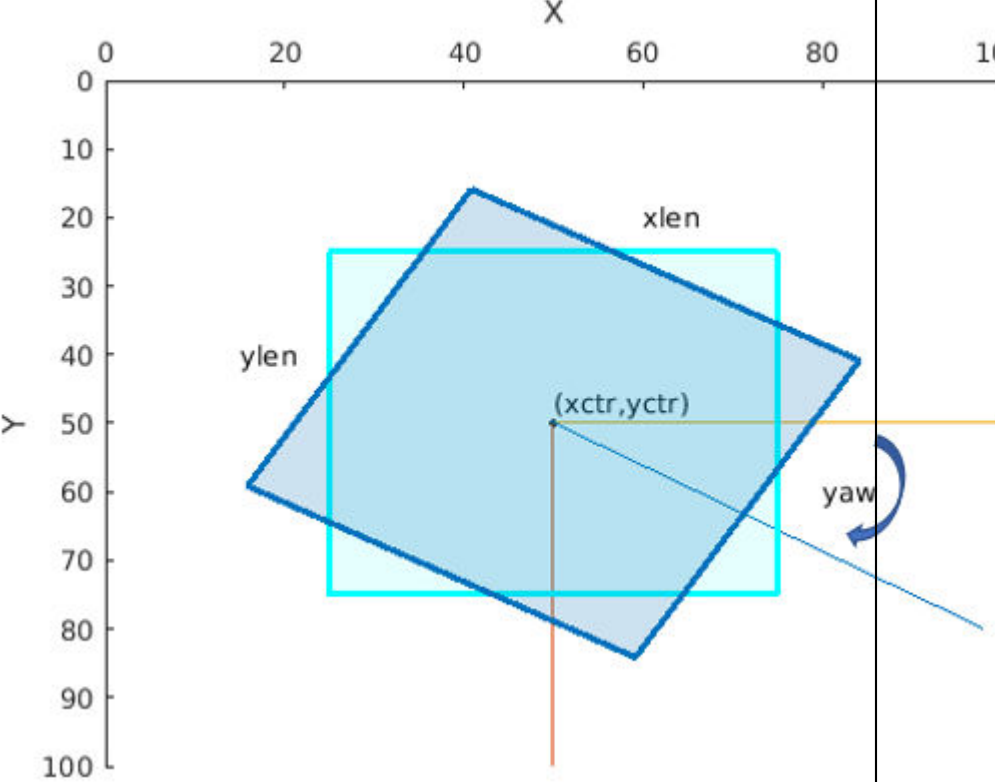
Bounding Box	Description
Rotated rectangle	<p>Defined in spatial coordinates as an M-by-5 numeric matrix with rows of the form $[xctr\ yctr\ xlen\ ylen\ yaw]$, where:</p> <ul style="list-style-type: none"> M is the number of rotated rectangles. $xctr$ and $yctr$ specify the center of the rectangle. $xlen$ specifies the width of the rectangle, which is its length along the x-axis before rotation. $ylen$ specifies the height of the rectangle, which is its length along the y-axis before rotation. yaw specifies the rotation angle in degrees. The rotation is clockwise-positive around the center of the bounding box. 

Data Types: single | double | int8 | int16 | int32 | uint8 | uint16 | uint32

scores — Confidence scores

M -by-1 vector

Confidence scores corresponding to the input bounding boxes, specified as an M -by-1 vector. The `selectStrongestBboxMulticlass` function uses greedy NMS to eliminate overlapping bounding boxes and associate the confidence score with the boxes. A higher score represents a higher confidence in keeping the bounding box. The scores input must be real, finite, and nonsparse.

Data Types: single | double | int8 | int16 | int32 | uint8 | uint16 | uint32

Labels — Labels*M*-by-1 categorical vector | *M*-by-1 numeric vector

Labels corresponding to the input bounding boxes, specified as an *M*-by-1 categorical or numeric vector.

Data Types: `single` | `double` | `int8` | `int16` | `int32` | `uint8` | `uint16` | `uint32` | `categorical`

Name-Value Pair Arguments

Specify optional comma-separated pairs of `Name`, `Value` arguments. `Name` is the argument name and `Value` is the corresponding value. `Name` must appear inside quotes. You can specify several name and value pair arguments in any order as `Name1, Value1, ..., NameN, ValueN`.

Example: `'RatioType', 'Union'` sets the `'RatioType'` property to `'Union'`.

RatioType — Bounding box overlap ratio denominator`'Union'` (default) | `'Min'`

Ratio type, specified as the character vector `'Union'` or `'Min'`.

- Set the ratio type to `'Union'` to compute the ratio as the area of intersection between `bboxA` and `bboxB`, divided by the area of the union of the two.
- Set the ratio type to `'Min'` to compute the ratio as the area of intersection between `bboxA` and `bboxB`, divided by the minimum area of the two bounding boxes.

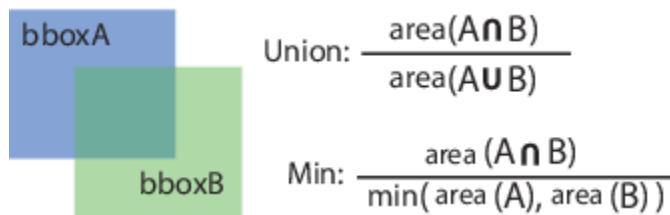

Data Types: `char`

OverlapThreshold — Overlap ratio threshold`0.5` (default) | scalar in the range [0 1]

Overlap ratio threshold, specified as the comma-separated pair consisting of `'OverlapThreshold'` and a scalar in the range [0 1]. When the overlap ratio is above the threshold, the function removes bounding boxes around the reference box. Decrease the threshold to reduce the number of selected bounding boxes. However, if you decrease the threshold too much, you might eliminate boxes that represent objects close to each other in the image.

Data Types: `single` | `double`

NumStrongest — Maximum number of strongest boxes`inf` (default) | positive scalar

Maximum number of strongest boxes, specified as the comma-separated pair consisting of `'NumStrongest'` and `inf` or a positive scalar. Use this argument to reduce processing time when you have a priori knowledge about the maximum number of boxes. Set the value to `inf` to select all the strongest, non-overlapping, bounding boxes.

When the `labels` input contains categorical labels, you can also specify a vector that contains the maximum number of strongest boxes for each category in the `labels` input. The length of the specified vector must equal the number of categories in the label.

Output Arguments

selectedBboxes — Selected bounding boxes

M-by-4 matrix | *M*-by-5 matrix

Selected bounding boxes, returned as an *M*-by-4 or an *M*-by-5 matrix. The 4-element vectors represent axis-aligned rectangles and the 5-element vectors represent rotated rectangles.

The `selectedBbox` output returns the selected bounding boxes from the `bbox` input that have the highest confidence score. The function uses nonmaximal suppression to eliminate overlapping bounding boxes.

Data Types: `single` | `double` | `int8` | `int16` | `int32` | `uint8` | `uint16` | `uint32`

selectedScores — Scores of selected bounding boxes

M-by-1 vector

Scores of selected bounding boxes, returned as an *M*-by-1 vector. The *M*th score in the `selectedScores` output corresponds to the *M*th bounding box in the `selectedBboxes` output. The data type of `selectedScores` matches the data type of `scores`.

selectedLabels — Labels of selected bounding boxes

M-by-1 categorical vector | *M*-by-1 numeric vector

Labels of selected bounding boxes, returned as an *M*-by-1 categorical or numeric vector. The *M*th label in the `selectedLabels` output corresponds to the *M*th bounding box in the `selectedBboxes` output. The data type of `selectedLabels` matches the data type of `labels`.

index — Index of selected bounding boxes

M-by-1 vector

Index of selected bounding boxes, returned as an *M*-by-1 vector. The `index` vector contains the indices to the selected boxes in the `bboxes` input.

Data Types: `double`

Extended Capabilities

C/C++ Code Generation

Generate C and C++ code using MATLAB® Coder™.

Usage notes and limitations:

- Code generation is not supported for rotated rectangle bounding box inputs.

GPU Code Generation

Generate CUDA® code for NVIDIA® GPUs using GPU Coder™.

Usage notes and limitations:

- GPU Code generation is not supported for rotated rectangle bounding box inputs.

GPU Arrays

Accelerate code by running on a graphics processing unit (GPU) using Parallel Computing Toolbox™.

Usage notes and limitations:

- GPU Arrays is not supported for rotated rectangle bounding box inputs.

See Also

`bboxOverlapRatio` | `selectStrongestBbox`

Introduced in R2018a

showExtrinsics

Visualize extrinsic camera parameters

Syntax

```
showExtrinsics(cameraParams)
showExtrinsics(cameraParams,view)
showExtrinsics( ____,Name,Value)
```

```
ax = showExtrinsics( ____ )
```

Description

`showExtrinsics(cameraParams)` renders a 3-D visualization of extrinsic parameters of a single calibrated camera or a calibrated stereo pair. The function plots a 3-D view of the calibration patterns with respect to the camera. The `cameraParams` input contains either a `cameraParameters`, `fisheyeParameters`, or a `stereoParameters` object, which the `estimateCameraParameters` or `estimateFisheyeParameters` function returns.

The `showExtrinsics` function shows the 3-D view of the calibration pattern as a convex polygon containing all the detected keypoints of the pattern in the original calibration image.

`showExtrinsics(cameraParams,view)` displays visualization of the camera extrinsic parameters using the style specified by the `view` input.

`showExtrinsics(____,Name,Value)` uses additional options specified by one or more `Name,Value` pair arguments, using any of the preceding syntaxes.

`ax = showExtrinsics(____)` returns the plot axis, using any of the preceding syntaxes.

Examples

Visualize Single Camera Extrinsic Parameters

Create a set of calibration images.

```
images = imageDatastore(fullfile(toolboxdir('vision'),'visiondata', ...
    'calibration','webcam'));
imageFileNames = images.Files(1:5);
```

Detect calibration pattern.

```
[imagePoints,boardSize] = detectCheckerboardPoints(imageFileNames);
```

Generate world coordinates of the corners of the squares. The square size is in millimeters.

```
squareSide = 25;
worldPoints = generateCheckerboardPoints(boardSize,squareSide);
```

Calibrate the camera.

```
I = readimage(images,1);  
imageSize = [size(I, 1), size(I, 2)];  
cameraParams = estimateCameraParameters(imagePoints,worldPoints, ...  
    'ImageSize',imageSize);
```

Visualize pattern locations.

```
figure  
showExtrinsics(cameraParams);
```

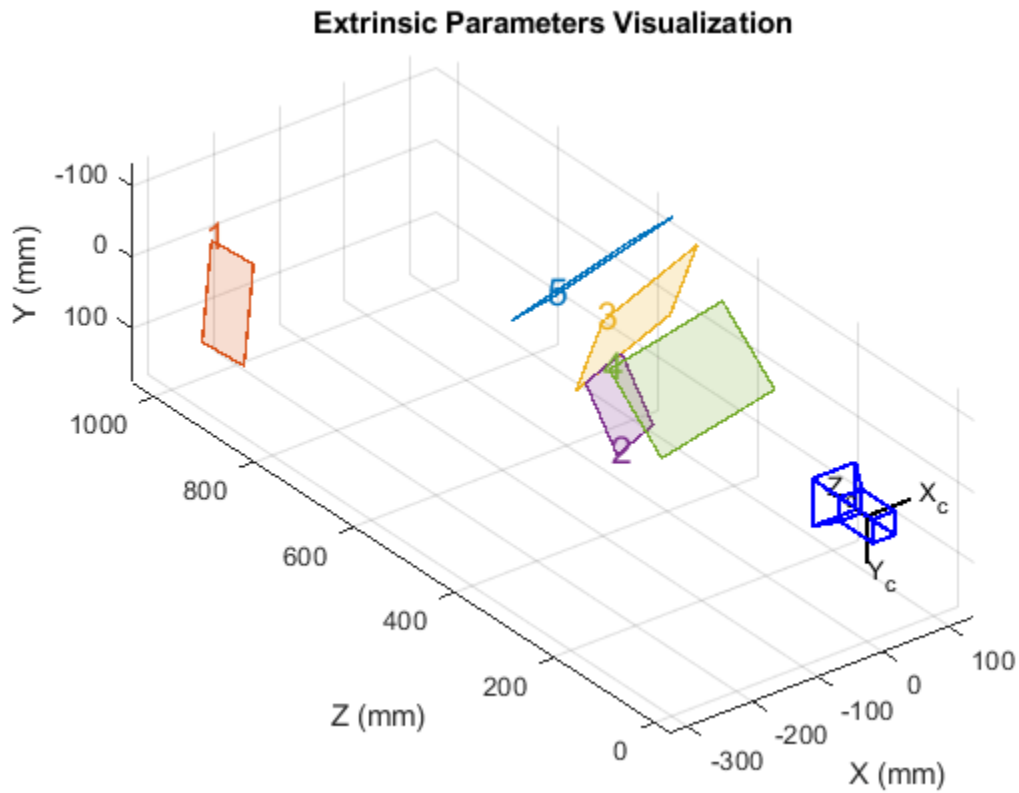

Visualize camera locations.

```
figure  
showExtrinsics(cameraParams, 'patternCentric');
```

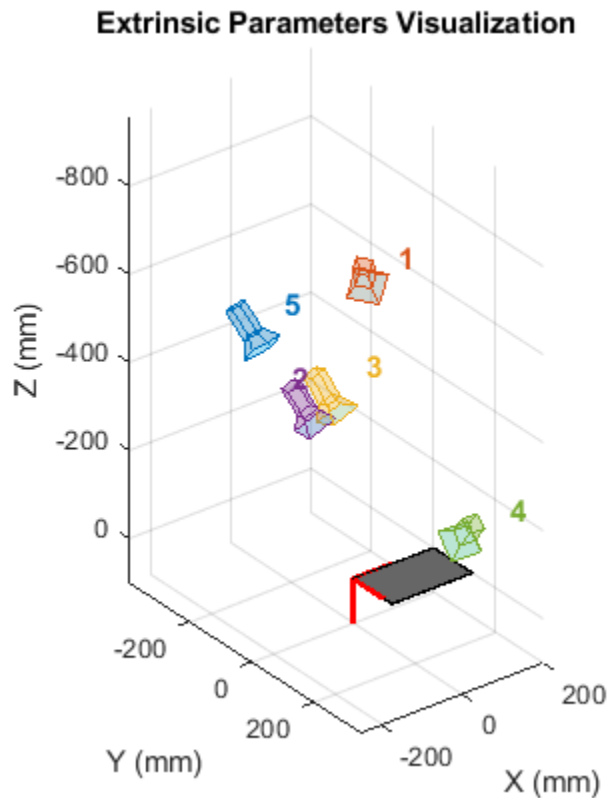
Visualize Stereo Pair of Camera Extrinsic Parameters

Specify calibration images.

```
imageDir = fullfile(toolboxdir('vision'),'visiondata',...
    'calibration','circleGrid','stereo');
leftImages = imageDatastore(fullfile(imageDir,'left'));
rightImages = imageDatastore(fullfile(imageDir,'right'));
leftImageFileNames = leftImages.Files(2:2:10);
rightImageFileNames = rightImages.Files(2:2:10);
```

Define the circle grid pattern dimensions, and detect the pattern in the images.

```
patternDims = [4 11];
imagePoints = detectCircleGridPoints(leftImageFileNames,...
    rightImageFileNames,patternDims);
```

Specify the world coordinates for the circle grid keypoints. Center distance is in millimeters.

```
centerDistance = 36.5;
worldPoints = generateCircleGridPoints(patternDims,centerDistance);
```

Calibrate the stereo camera system. Both cameras have the same resolution.

```
I = readimage(leftImages,1);
imageSize = [size(I,1),size(I,2)];
```

```
cameraParams = estimateCameraParameters(imagePoints,worldPoints,...  
    'ImageSize',imageSize);
```

Visualize pattern locations.

```
figure  
showExtrinsics(cameraParams)
```

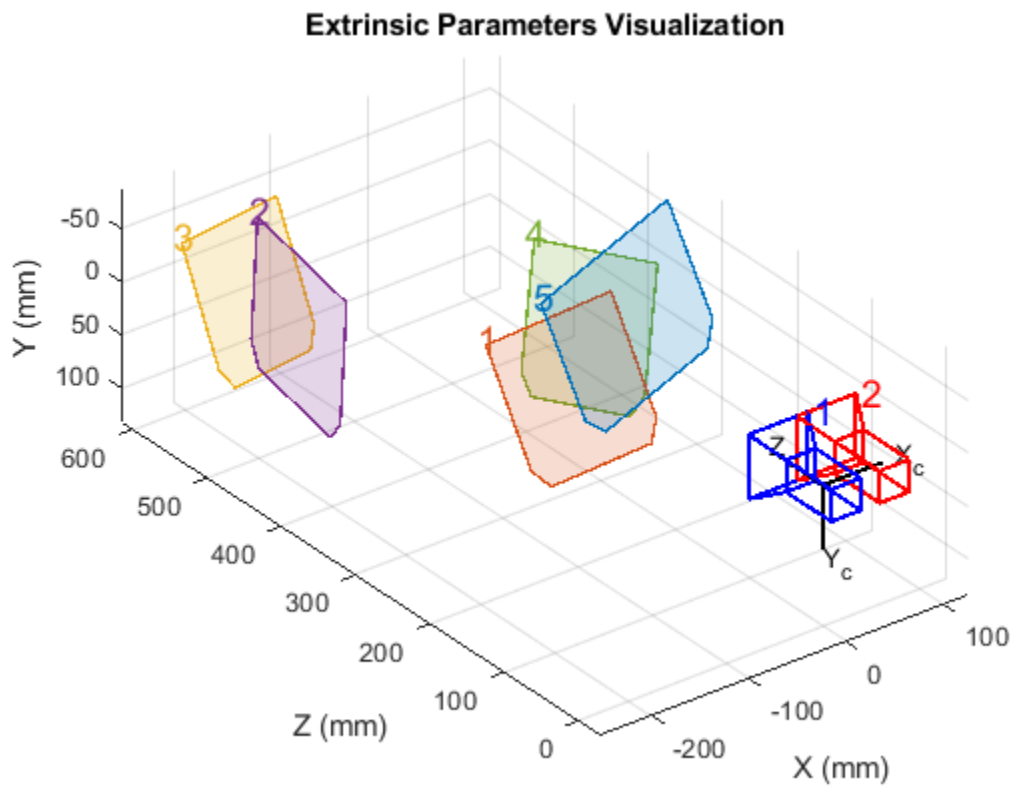

Visualize camera locations.

```
figure  
showExtrinsics(cameraParams,'patternCentric')
```

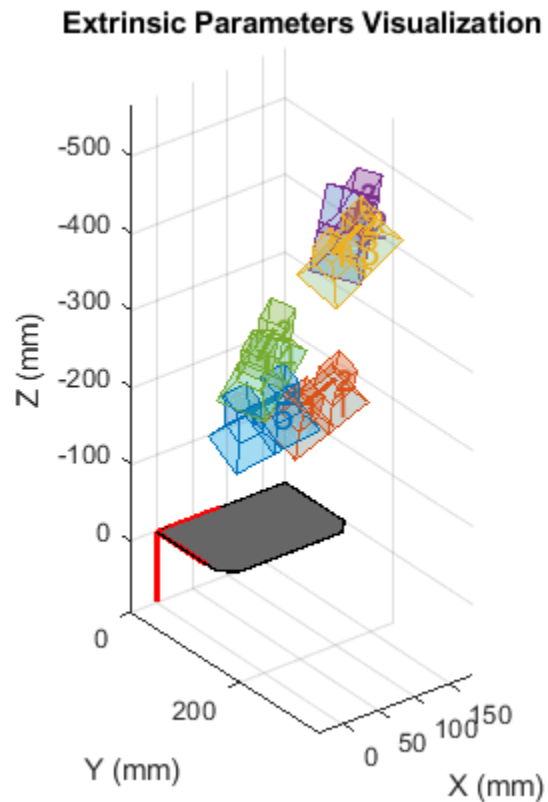

Input Arguments

cameraParams — Object containing parameters of single camera or stereo pair

cameraParameters object | fisheyeParameters object | stereoParameters object

Object containing parameters of single camera or stereo pair, specified as either a `cameraParameters`, `fisheyeParameters`, or `stereoParameters` object. You can create the single camera or stereo pair input object using the `estimateCameraParameters` function. The fisheye parameters input object is created using `estimateFisheyeParameters`.

You can also use the **Camera Calibrator** app to create the `cameraParameters` input object, or use **Stereo Camera Calibrator** app to create the `stereoParameters` input object. See “Using the Single Camera Calibrator App” and “Using the Stereo Camera Calibrator App”.

view — Camera- or pattern-centric view

'CameraCentric' | 'PatternCentric'

Camera or pattern-centric view, specified as 'CameraCentric' or 'PatternCentric'. The view input sets the visualization for the camera extrinsic parameters. If you keep your camera stationary while moving the calibration pattern, set view to 'CameraCentric'. If the pattern is stationary while you move your camera, set it to 'PatternCentric'.

Name-Value Pair Arguments

Specify optional comma-separated pairs of `Name`, `Value` arguments. `Name` is the argument name and `Value` is the corresponding value. `Name` must appear inside quotes. You can specify several name and value pair arguments in any order as `Name1, Value1, . . . , NameN, ValueN`.

Example: `'HighlightIndex', [1, 4]` sets the `'HighlightIndex'` to patterns 1 and 4.

HighlightIndex — Highlight selection index

`[]` (default) | vector | scalar

Highlight selection index, specified as a scalar or a vector of integers. For example, if you want to highlight patterns 1 and 4, use `[1, 4]`. Doing so increases the opacity of patterns 1 and 4 in contrast to the rest of the patterns.

Parent — Output axes

current axes (default)

Output axes, specified as the comma-separated pair consisting of `'Parent'` and an axes. You can obtain the current axes handle by returning the function to an output variable:

```
ax = showExtrinsics(cameraParams)
```

You can also use the `gca` function to get the current axes handle.

Example: `showExtrinsics(cameraParams, 'Parent', ax)`

Output Arguments

ax — Current axes handle

scalar value

Current axes handle, returned as a scalar value. The function returns the handle to the current axes for the current figure.

Example: `ax = showExtrinsics(cameraParams)`

See Also

[Camera Calibrator](#) | [Stereo Camera Calibrator](#) | [plotCamera](#) | [estimateCameraParameters](#) | [showReprojectionErrors](#) | [undistortImage](#) | [detectCheckerboardPoints](#) | [generateCheckerboardPoints](#) | [cameraParameters](#) | [stereoParameters](#) | [fisheyeParameters](#)

Topics

“Using the Single Camera Calibrator App”

Introduced in R2014a

showMatchedFeatures

Display corresponding feature points

Syntax

```
showMatchedFeatures(I1,I2,matchedPoints1,matchedPoints2)
showMatchedFeatures(I1,I2,matchedPoints1,matchedPoints2,method)

showMatchedFeatures(___,PlotOptions, {MarkerStyle1, MarkerStyle2, LineStyle})

H = showMatchedFeatures(___)
```

Description

`showMatchedFeatures(I1,I2,matchedPoints1,matchedPoints2)` displays a falsecolor overlay of images `I1` and `I2` with a color-coded plot of corresponding points connected by a line. `matchedPoints1` and `matchedPoints2` contain the coordinates of corresponding points in `I1` and `I2`. The input points can be M -by-2 matrices of M number of $[x\ y]$ coordinates, or `SURFPoints`, `MSERRegions`, `ORBPoints`, `BRISKPoints`, or `cornerPoints` object.

`showMatchedFeatures(I1,I2,matchedPoints1,matchedPoints2,method)` displays images `I1` and `I2` using the visualization style specified by the `method` parameter.

`showMatchedFeatures(___,PlotOptions, {MarkerStyle1, MarkerStyle2, LineStyle})` lets you specify custom plot options in a cell array containing three values. The `MarkerStyle1`, `MarkerStyle2`, and `LineStyle` values correspond to the marker symbol in `I1`, marker symbol in `I2`, and the line style and color. The `LineStyle` syntax of the `plot` function defines each of the specifiers.

`H = showMatchedFeatures(___)` returns the handle to the image object returned by `showMatchedFeatures`.

Examples

Find Corresponding Points Between Two Images Using Harris Features

Read Images.

```
I1 = rgb2gray(imread('parkinglot_left.png'));
I2 = rgb2gray(imread('parkinglot_right.png'));
```

Detect SURF features

```
points1 = detectHarrisFeatures(I1);
points2 = detectHarrisFeatures(I2);
```

Extract features

```
[f1, vpts1] = extractFeatures(I1, points1);
[f2, vpts2] = extractFeatures(I2, points2);
```

Match features.

```
indexPairs = matchFeatures(f1, f2) ;
matchedPoints1 = vpts1(indexPairs(1:20, 1));
matchedPoints2 = vpts2(indexPairs(1:20, 2));
```

Visualize candidate matches.

```
figure; ax = axes;
showMatchedFeatures(I1,I2,matchedPoints1,matchedPoints2,'montage','Parent',ax);
title(ax, 'Candidate point matches');
legend(ax, 'Matched points 1','Matched points 2');
```

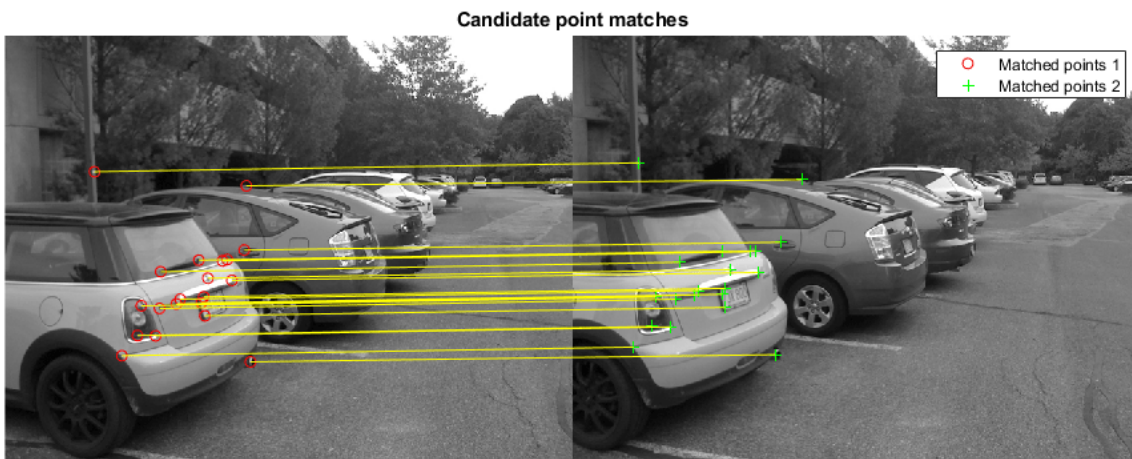
**Display Corresponding Points Between Two Rotated and Scaled Images**

Use SURF features to find corresponding points between two images rotated and scaled with respect to each other.

Read images.

```
I1 = imread('cameraman.tif');
I2 = imresize(imrotate(I1,-20), 1.2);
```

Detect SURF features.

```
points1 = detectSURFFeatures(I1);
points2 = detectSURFFeatures(I2);
```

Extract features.

```
[f1, vpts1] = extractFeatures(I1, points1);
[f2, vpts2] = extractFeatures(I2, points2);
```

Match features.

```
indexPairs = matchFeatures(f1, f2) ;
matchedPoints1 = vpts1(indexPairs(:, 1));
matchedPoints2 = vpts2(indexPairs(:, 2));
```

Visualize candidate matches.

```
figure; ax = axes;
showMatchedFeatures(I1,I2,matchedPoints1,matchedPoints2,'Parent',ax);
title(ax, 'Putative point matches');
legend(ax, 'Matched points 1', 'Matched points 2');
```

**Input Arguments****I1 – Input image**

numeric array

Input image one, specified as a numeric array.

I2 – Input image

numeric array

Input image two, specified as a numeric array.

matchedPoints1 — Coordinates of points

M-by-2 matrix | SURFPoints object | MSERRegions object | ORBPoints object | BRISKPoints object | cornerPoints object

Coordinates of points in image one, specified as an *M*-by-2 matrix of *M* number of [x y] coordinates, or as a SURFPoints, MSERRegions, ORBPoints, BRISKPoints, or cornerPoints object.

matchedPoints2 — Coordinates of points

M-by-2 matrix | SURFPoints object | MSERRegions object | ORBPoints object | BRISKPoints object | cornerPoints object

Coordinates of points in image two, specified as an *M*-by-2 matrix of *M* number of [x y] coordinates, or as a SURFPoints, MSERRegions, ORBPoints, BRISKPoints, or cornerPoints object.

method — Display method

falsecolor (default) | blend | montage

Display style method, specified as one of the following:

 falsecolor: Overlay the images by creating a composite red-cyan image showing I1 as red and I2 as cyan.

 blend: Overlay I1 and I2 using alpha blending.

 montage: Place I1 and I2 next to each other in the same image.

Name-Value Pair Arguments

Specify optional comma-separated pairs of Name, Value arguments. Name is the argument name and Value is the corresponding value. Name must appear inside quotes. You can specify several name and value pair arguments in any order as Name1, Value1, . . . , NameN, ValueN.

Example:

PlotOptions — Line style and color

{'ro', 'g+', 'y-'} (default) | cell array of character vectors | string array

Line style and color options, specified as a cell array of character vectors or a string array. The three values {MarkerStyle1, MarkerStyle2, LineStyle}, correspond to, a marker symbol in I1, marker symbol in I2, and the line style and color. The LineSpec syntax of the plot function defines each of the specifiers.

Parent — Output axes

axes graphics object

Output axes for displaying visualization, specified as an axes graphics object.

Output Arguments**H — Handle to image object**

handle

Handle to image object, returned as the handle to the image object returned by showMatchedFeatures.

See Also

[matchFeatures](#) | [SURFPoints](#) | [MSERRegions](#) | [ORBPoints](#) | [BRISKPoints](#) | [cornerPoints](#) | [estimateGeometricTransform](#) | [legend](#) | [imshowpair](#)

Introduced in R2012b

showPointCloud

Plot 3-D point cloud

Syntax

```
showPointCloud
```

Description

showPointCloud was renamed to pcshow. Please use pcshow in place of showPointCloud.

Introduced in R2014b

pcshow

Plot 3-D point cloud

Syntax

```
pcshow(ptCloud)

pcshow(xyzPoints)
pcshow(xyzPoints,color)
pcshow(xyzPoints,colorMap)
pcshow(filename)

pcshow( ____,Name,Value)

ax = pshow( ____)
```

Description

`pcshow(ptCloud)` displays points using the locations and colors stored in the point cloud object.

`pcshow(xyzPoints)` displays points specified by the `xyzPoints` matrix.

`pcshow(xyzPoints,color)` displays points contained in the `xyzPoints` matrix, with colors specified by `color`.

`pcshow(xyzPoints,colorMap)` displays points contained in the `xyzPoints` matrix, with colors specified by `colorMap`.

`pcshow(filename)` displays the point cloud stored in the file specified by `filename`.

`pcshow(____,Name,Value)` uses additional options specified by one or more `Name,Value` pair arguments, using any of the preceding syntaxes.

`ax = pshow(____)` returns the plot axes.

Examples

Plot Spherical Point Cloud with Texture Mapping

Generate a sphere consisting of 600-by-600 faces.

```
numFaces = 600;
[x,y,z] = sphere(numFaces);
```

Plot the sphere using the default color map.

```
figure;
pcshow([x(:),y(:),z(:)]);
title('Sphere with Default Color Map');
xlabel('X');
```

```
ylabel('Y');  
zlabel('Z');
```

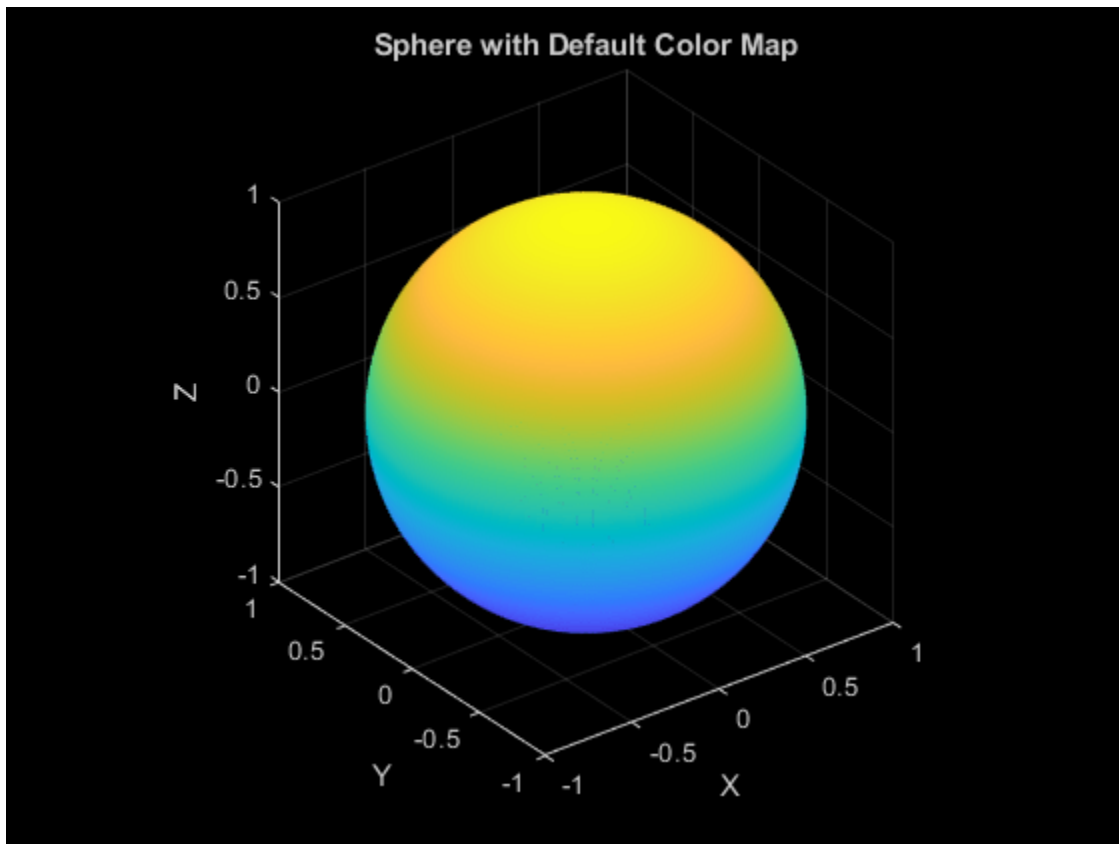

Load and display an image for texture mapping.

```
I = im2double(imread('visionteam1.jpg'));  
imshow(I);
```



Resize and flip the image for mapping the coordinates.

```
J = flipud(imresize(I,size(x)));
```

Plot the sphere with the color texture.

```
pcshow([x(:),y(:),z(:)],reshape(J,[],3));  
title('Sphere with Color Texture');  
xlabel('X');  
ylabel('Y');  
zlabel('Z');
```

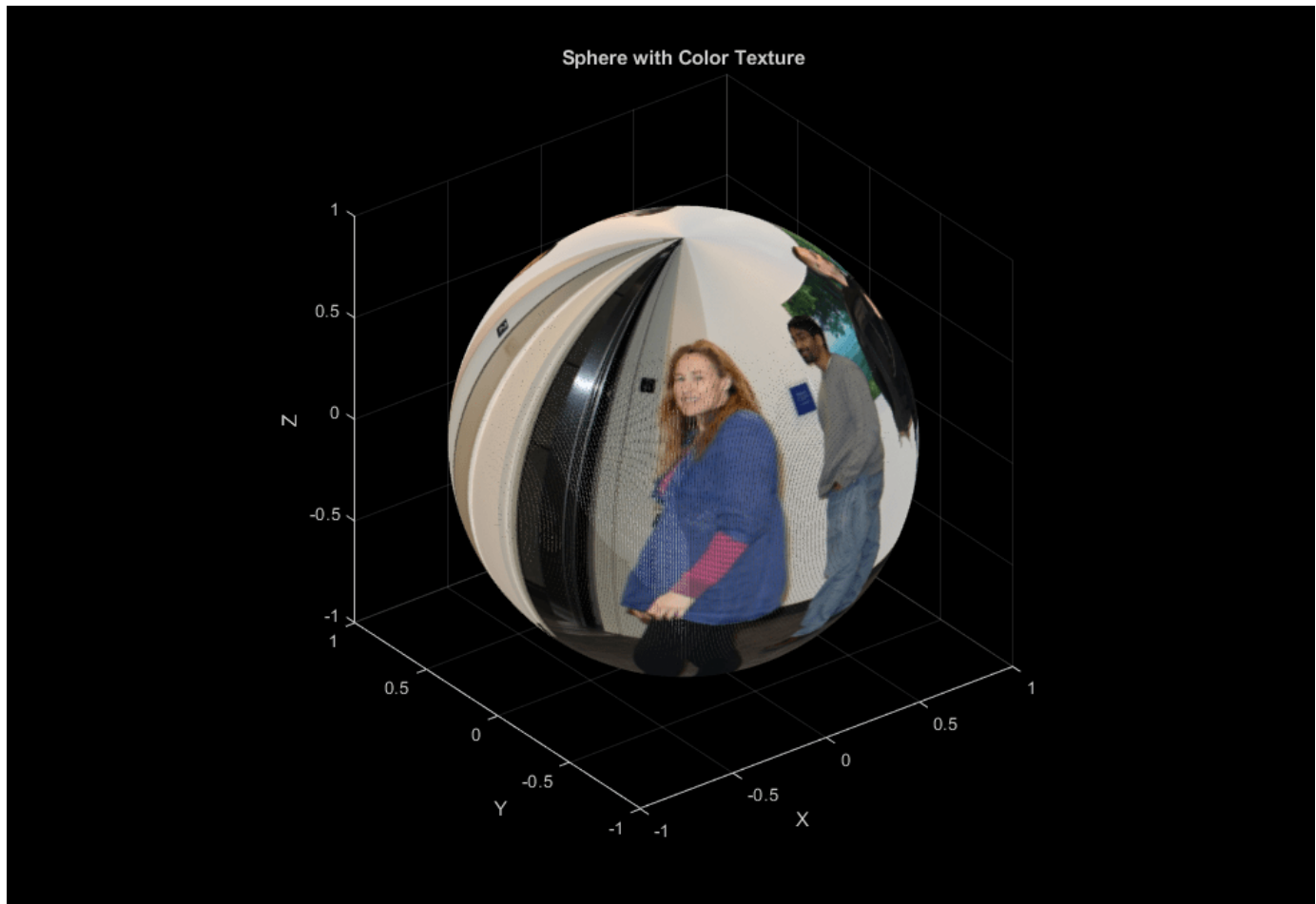

Input Arguments

ptCloud — Point cloud

pointCloud object

Point cloud, specified as a `pointCloud` object. The object contains the locations, intensities, and RGB colors to render the point cloud.

Point Cloud Property	Color Rendering Result
Location only	Maps the z-value to a color value in the current color map.
Location and Intensity	Maps the intensity to a color value in the current color map.
Location and Color	Use provided color.
Location, Intensity, and Color	Use provided color.

filename — Point cloud filename

character vector | string scalar

Point cloud filename, specified as a character vector or a scalar string. The file must be supported by `pcread`. `pcshow` calls `pcread` to read the point cloud from the file, but does not store the data in the MATLAB workspace.

xyzPoints — Point cloud x, y, and z locations

M-by-3 matrix | *M*-by-*N*-by-3 matrix

Point cloud *x*, *y*, and *z* locations, specified as either an *M*-by-3 or an *M*-by-*N*-by-3 numeric matrix. The `xyzPoints` numeric matrix contains *M* or *M*-by-*N* [*x*,*y*,*z*] points. The *z* values in the matrix, which generally corresponds to depth or elevation, determine the color of each point. When you do not specify the `C` input color, the function maps the *z* value to a color in the current colormap.

color — Color for points in the point cloud

1-by-3 RGB vector | short name of color | long name of color | *M*-by-3 matrix | *M*-by-*N*-by-3 matrix

Color for points in the point cloud, specified as a 1-by-3-*RGB* vector, an *M*-by-3 matrix, an *M*-by-*N*-by-3 matrix, a short color name, or a long color name. For details on color values, see the Color Value on page 3-883 table.

You can specify the same color for all points or a different color for each point. When you set `color` to `single` or `double`, the *RGB* values range between [0, 1]. When you set `color` to `uint8`, the values range between [0, 255].

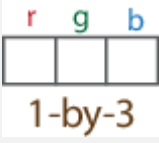
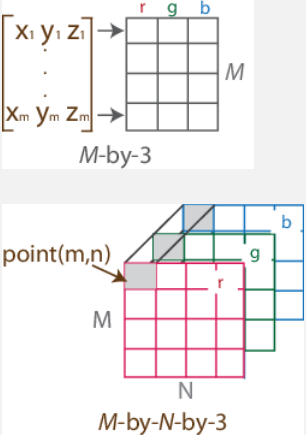
Points Input	Color Selection	Valid Values of C	
xyzPoints	Same color for all points	1-by-3 RGB vector, or a color name or short name, listed in the Color Value on page 3-883 table.	
	Different color for each point	<i>M</i> -by-3 matrix or <i>M</i> -by- <i>N</i> -by-3 matrix containing <i>RGB</i> values for each point.	

colorMap — Point cloud color map

M-by-1 vector | *M*-by-*N* matrix

Point cloud color of points, specified as one of:

- *M*-by-1 vector
- *M*-by-*N* matrix

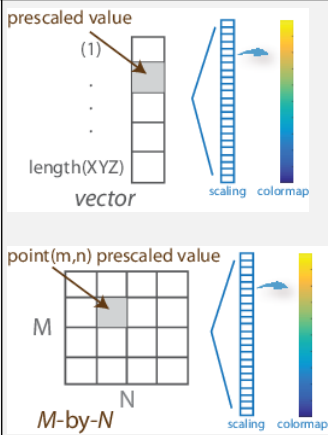
Points Input	Color Selection	Valid Values of C
xyzPoints	Different color for each point	<p>Vector or M-by-N matrix. The matrix must contain values that are linearly mapped to a color in the current colormap.</p> 

Name-Value Pair Arguments

Specify optional comma-separated pairs of Name, Value arguments. Name is the argument name and Value is the corresponding value. Name must appear inside quotes. You can specify several name and value pair arguments in any order as Name1, Value1, . . . , NameN, ValueN.

Example: 'VerticalAxisDir', 'Up' sets the vertical axis direction to up.

MarkerSize — Diameter of marker

6 (default) | positive scalar

Diameter of marker, specified as a positive scalar. The value specifies the approximate diameter of the point marker. MATLAB graphics define the unit as points. A marker size larger than six can reduce the rendering performance.

BackgroundColor — Background color

[0 0 0] (black) (default) | RGB triplet | hexadecimal color code | character vector

Background color, specified as an RGB triplet, hexadecimal color code, or a character vector that specifies a long or short color name.

VerticalAxis — Vertical axis

'Z' (default) | 'X' | 'Y'

Vertical axis, specified as 'X', 'Y', or 'Z'. When you reload a saved figure, any action on the figure resets the vertical axis to the z-axis.

VerticalAxisDir — Vertical axis direction

'Up' (default) | 'Down'

Vertical axis direction, specified as 'Up' or 'Down'. When you reload a saved figure, any action on the figure resets the direction to the up direction.

Parent — Axes on which to display the visualization

axes graphics object

Axes on which to display the visualization, specified as an Axes object. To create an Axes object, use the axes function. To display the visualization in a new figure, leave 'Parent' unspecified.

Output Arguments

ax — Plot axes









axes graphics object

Plot axes, returned as an axes graphics object.

You can set the default center of rotation for the point cloud viewer to rotate around the axes center or around a point. Set the default behavior from the “Computer Vision Toolbox Preferences”.

More About

Color Value

Color Name	Short Name	RGB Triplet	Appearance
'red'	'r'	[1 0 0]	
'green'	'g'	[0 1 0]	
'blue'	'b'	[0 0 1]	
'cyan'	'c'	[0 1 1]	
'magenta'	'm'	[1 0 1]	
'yellow'	'y'	[1 1 0]	
'black'	'k'	[0 0 0]	
'white'	'w'	[1 1 1]	

Tips

- To improve performance, `pcshow` automatically downsamples the rendered point cloud when you rotate, pan, or zoom in or out by clicking the mouse. Downsampling is not applied for zoom in or out by using the mouse scroll mechanism. When using data tips, no downsampling is applied. The downsampling occurs only for rendering the point cloud and does not affect the saved points.
- To view point data or modify color display values, hover over the axes toolbar and select one of the following options.

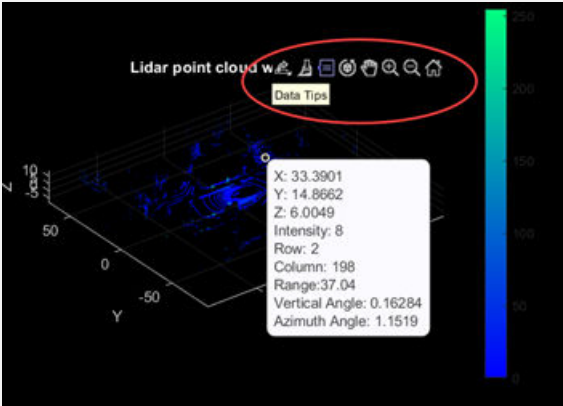
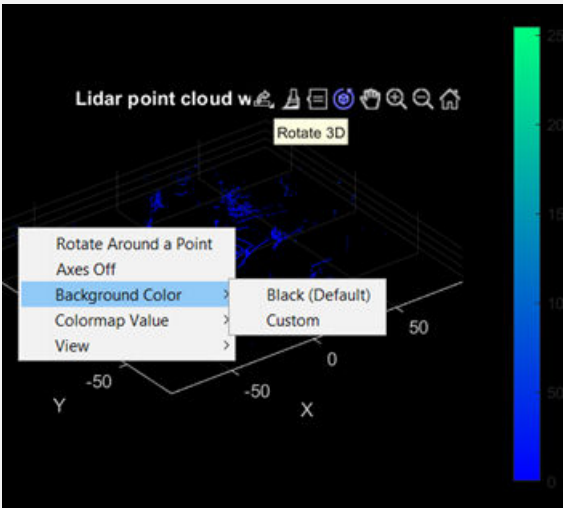
Feature	Description						
Datatip	<p>Click Data Tips to view the data point values for any point in the point cloud figure. For a normal point cloud, the Data Tips displays the x,y,z values. Additional data properties for the depth image and lidar are:</p> <table border="1" data-bbox="659 449 1466 611"> <thead> <tr> <th>Point Cloud Data</th> <th>Data Value Properties</th> </tr> </thead> <tbody> <tr> <td>Depth image (RGB-D sensor)</td> <td>Color, row, column</td> </tr> <tr> <td>Lidar</td> <td>Intensity, range, azimuth angle, elevation angle, row, column</td> </tr> </tbody> </table> 	Point Cloud Data	Data Value Properties	Depth image (RGB-D sensor)	Color, row, column	Lidar	Intensity, range, azimuth angle, elevation angle, row, column
Point Cloud Data	Data Value Properties						
Depth image (RGB-D sensor)	Color, row, column						
Lidar	Intensity, range, azimuth angle, elevation angle, row, column						
Background color	<p>Click Rotate and then right-click in the figure for background options.</p> 						

Feature	Description
Colormap value	<p>Click Rotate and then right-click in the figure for colormap options. You can modify colormap values for the coordinate and range values available, depending on the type of point cloud displayed.</p> 
View	<p>Click Rotate to change the viewing angle of the point cloud figure to the XZ, ZX, YZ, ZY, XY, or the YX plane. Click Restore View to reset the viewing angle.</p> 

- pcplayer supports the 'opengl' option for the Renderer figure property only.

See Also

showShape | pointCloud | pcplayer | pcshowpair | planeModel | plot3 | pcwrite | pcread | pcmerge | scatter3 | reconstructScene | triangulate | pcdsample | pcfitsphere | pcdnoise | pcregistericp

Topics

“Structure From Motion From Two Views”

“Depth Estimation From Stereo Video”

“Choose Function to Visualize Detected Objects”

“Coordinate Systems”

Introduced in R2015b

pcshowpair

Visualize difference between two point clouds

Syntax

```
pcshowpair(ptCloudA,ptCloudB)
pcshowpair(ptCloudA,ptCloudB,Name,Value)
ax = pcshowpair( ___ )
```

Description

`pcshowpair(ptCloudA,ptCloudB)` creates a visualization depicting the differences between the two input point clouds. The differences are displayed using a blending of magenta for point cloud A and green for point cloud B.

`pcshowpair(ptCloudA,ptCloudB,Name,Value)` visualizes the differences using additional options specified by one or more `Name, Value` pair arguments.

`ax = pcshowpair(___)` returns the plot axes to the visualization of the differences, using any of the preceding syntaxes.

Examples

Visualize the Difference Between Two Point Clouds

Load two point clouds that were captured using a Kinect device in a home setting.

```
load('livingRoom');
pc1 = livingRoomData{1};
pc2 = livingRoomData{2};
Plot and set the viewpoint of point clouds.
figure
pcshowpair(pc1,pc2,'VerticalAxis','Y','VerticalAxisDir','Down')
title('Difference Between Two Point Clouds')
xlabel('X(m)')
ylabel('Y(m)')
zlabel('Z(m)')
```

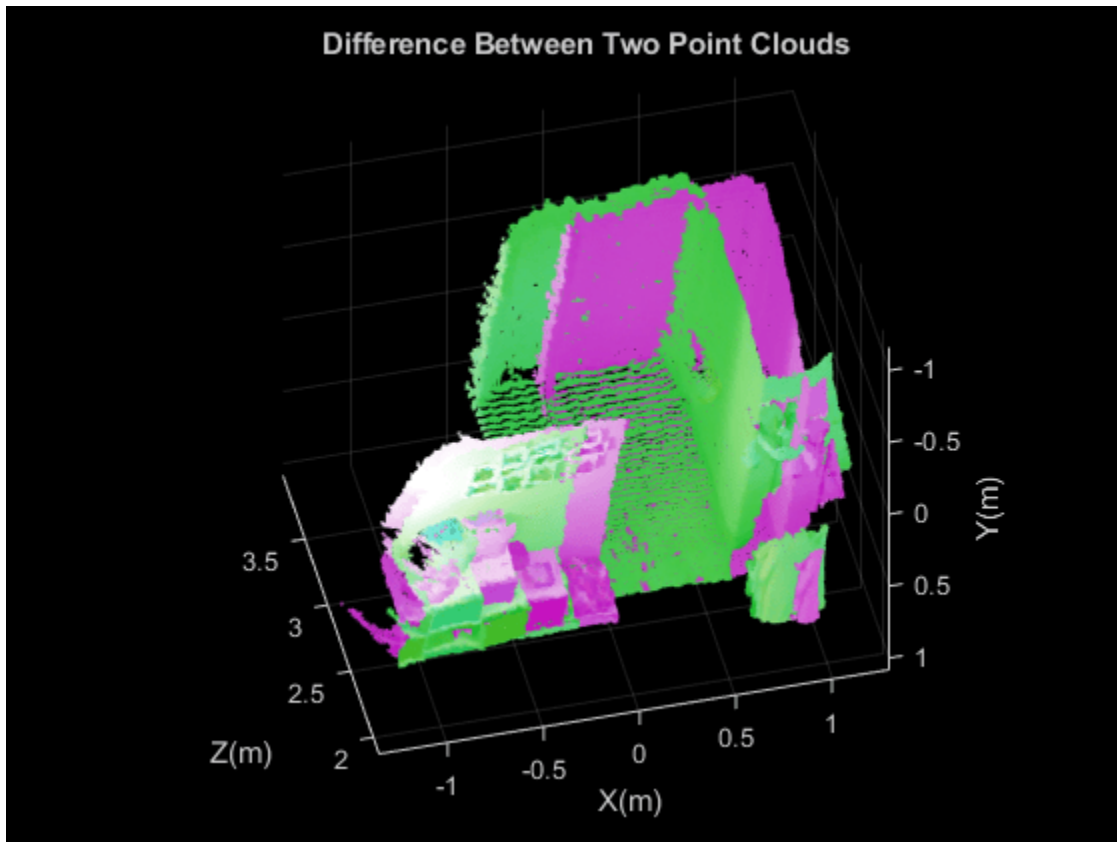

Input Arguments

ptCloudA — Point cloud

pointCloud object

Point cloud A, specified as a pointCloud object. The function uses levels of magenta to represent ptCloudA and a pure magenta when the point cloud contains no color information.

ptCloudB — Point cloud

pointCloud object

Point cloud B, specified as a pointCloud object. The function uses levels of green to represent ptCloudB and a pure green when the point cloud contains no color information.

Name-Value Pair Arguments

Specify optional comma-separated pairs of Name, Value arguments. Name is the argument name and Value is the corresponding value. Name must appear inside quotes. You can specify several name and value pair arguments in any order as Name1, Value1, ..., NameN, ValueN.

Example: 'VerticalAxisDir', 'Up' sets the vertical axis direction to up.

MarkerSize — Diameter of marker

6 (default) | positive scalar

Approximate diameter of the point marker, specified as a positive scalar. The units are in points. A marker size larger than six can reduce the rendering performance.

BackgroundColor — Background color

[0 0 0] (black) (default) | RGB triplet | hexadecimal color code | character vector

Background color, specified as an RGB triplet, hexadecimal color code, or a character vector that specifies a long or short color name.

VerticalAxis — Vertical axis

'Z' (default) | 'X' | 'Y'

Vertical axis, specified as 'X', 'Y', or 'Z'. When you reload a saved figure, any action on the figure resets the vertical axis to the z-axis.

VerticalAxisDir — Vertical axis direction

'Up' (default) | 'Down'

Vertical axis direction, specified as 'Up' or 'Down'. When you reload a saved figure, any action on the figure resets the direction to the up direction.

Parent — Axes on which to display the visualization

axes graphics object

Axes on which to display the visualization, specified as an Axes object. To create an Axes object, use the `axes` function. To display the visualization in a new figure, leave 'Parent' unspecified.

Output Arguments

ax — Plot axes

axes graphics object



Plot axes, returned as an axes graphics object. Points with NaN or Inf coordinates are not displayed.

You can set the default center of rotation for the point cloud viewer to rotate around the axes center or around a point. Set the default behavior from the “Computer Vision Toolbox Preferences”.

Tips

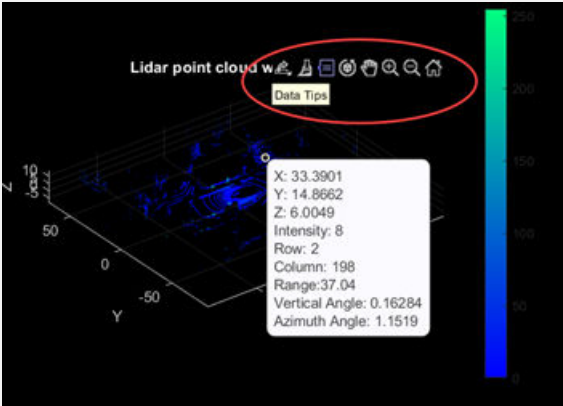
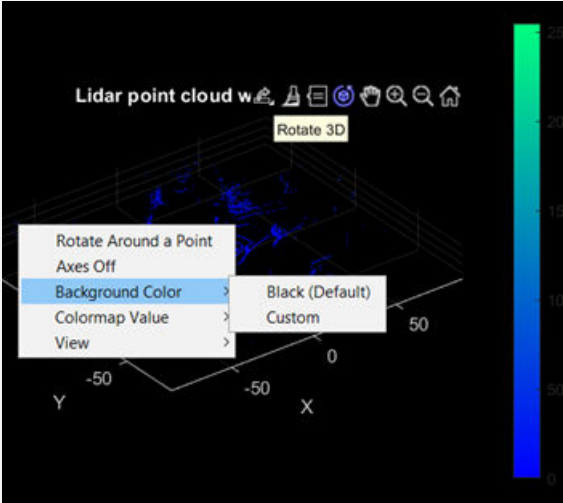
- To improve performance, `pcshowpair` automatically downsamples the rendered point cloud during interaction with the figure. The downsampling occurs only for rendering the point cloud and does not affect the saved points.
- To view point data or modify color display values, hover over the axes toolbar and select one of the following options.

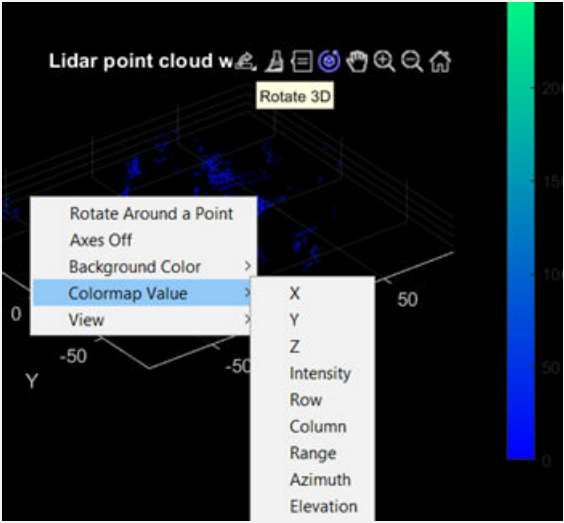
Feature	Description						
Datatip	<p>Click Data Tips to view the data point values for any point in the point cloud figure. For a normal point cloud, the Data Tips displays the x,y,z values. Additional data properties for the depth image and lidar are:</p> <table border="1" data-bbox="659 449 1464 611"> <thead> <tr> <th>Point Cloud Data</th> <th>Data Value Properties</th> </tr> </thead> <tbody> <tr> <td>Depth image (RGB-D sensor)</td> <td>Color, row, column</td> </tr> <tr> <td>Lidar</td> <td>Intensity, range, azimuth angle, elevation angle, row, column</td> </tr> </tbody> </table> 	Point Cloud Data	Data Value Properties	Depth image (RGB-D sensor)	Color, row, column	Lidar	Intensity, range, azimuth angle, elevation angle, row, column
Point Cloud Data	Data Value Properties						
Depth image (RGB-D sensor)	Color, row, column						
Lidar	Intensity, range, azimuth angle, elevation angle, row, column						
Background color	<p>Click Rotate and then right-click in the figure for background options.</p> 						

Feature	Description
<p>Colormap value</p>	<p>Click Rotate and then right-click in the figure for colormap options. You can modify colormap values for the coordinate and range values available, depending on the type of point cloud displayed.</p> 
<p>View</p>	<p>Click Rotate to change the viewing angle of the point cloud figure to the XZ, ZX,YZ, ZY, XY, or the YX plane. Click Restore View to reset the viewing angle.</p> 

- pcshowpair supports the 'opengl' option for the Renderer figure property only.

See Also

pointCloud | pcplayer | planeModel | plot3 | pcwrite | pcread | pcshow | pcmerge | scatter3 | reconstructScene | triangulate | pcdownsampling | pcfitplane | pcdenoise | pcregistericp

Topics

“Structure From Motion From Two Views”
 “Depth Estimation From Stereo Video”
 “Coordinate Systems”

Introduced in R2015b

showReprojectionErrors

Visualize calibration errors

Syntax

```
showReprojectionErrors(cameraParams)
showReprojectionErrors(cameraParams,view)
showReprojectionErrors( ____,Name,Value)
```

```
ax = showReprojectionErrors( ____)
```

Description

`showReprojectionErrors(cameraParams)` displays a bar graph that represents the calibration accuracy for a single camera or for a stereo pair. The bar graph displays the mean reprojection error per image. The `cameraParams` input contains either a `cameraParameters`, `fisheyeParameters`, or a `stereoParameters` object, which the `estimateCameraParameters` or `estimateFisheyeParameters` function returns.

`showReprojectionErrors(cameraParams,view)` displays the reprojection errors using the visualization style specified by the `view` input.

`showReprojectionErrors(____,Name,Value)` uses additional options specified by one or more `Name,Value` pair arguments, using any of the preceding syntaxes.

`ax = showReprojectionErrors(____)` returns the plot axis, using any of the preceding syntaxes.

Examples

Visualize Reprojection Errors for a Single Camera

Create a set of calibration images.

```
images = imageDatastore(fullfile(toolboxdir('vision'),'visiondata', ...
    'calibration','webcam'));
imageFileNames = images.Files(1:5);
```

Detect calibration pattern.

```
[imagePoints, boardSize] = detectCheckerboardPoints(imageFileNames);
```

Generate world coordinates of the corners of the squares. The square size is in millimeters.

```
squareSize = 25;
worldPoints = generateCheckerboardPoints(boardSize,squareSize);
```

Calibrate the camera.

```
I = readimage(images,1);
imageSize = [size(I, 1), size(I, 2)];
```

```
params = estimateCameraParameters(imagePoints,worldPoints, ...  
                                'ImageSize',imageSize);
```

Visualize the errors as a bar graph.

```
subplot(1,2,1);  
showReprojectionErrors(params);
```

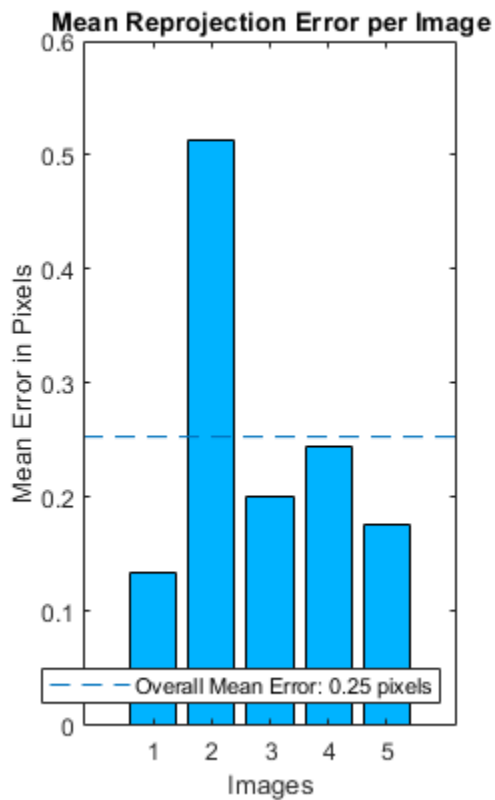

Visualize the errors as a scatter plot.

```
subplot(1,2,2);  
showReprojectionErrors(params, 'ScatterPlot');
```

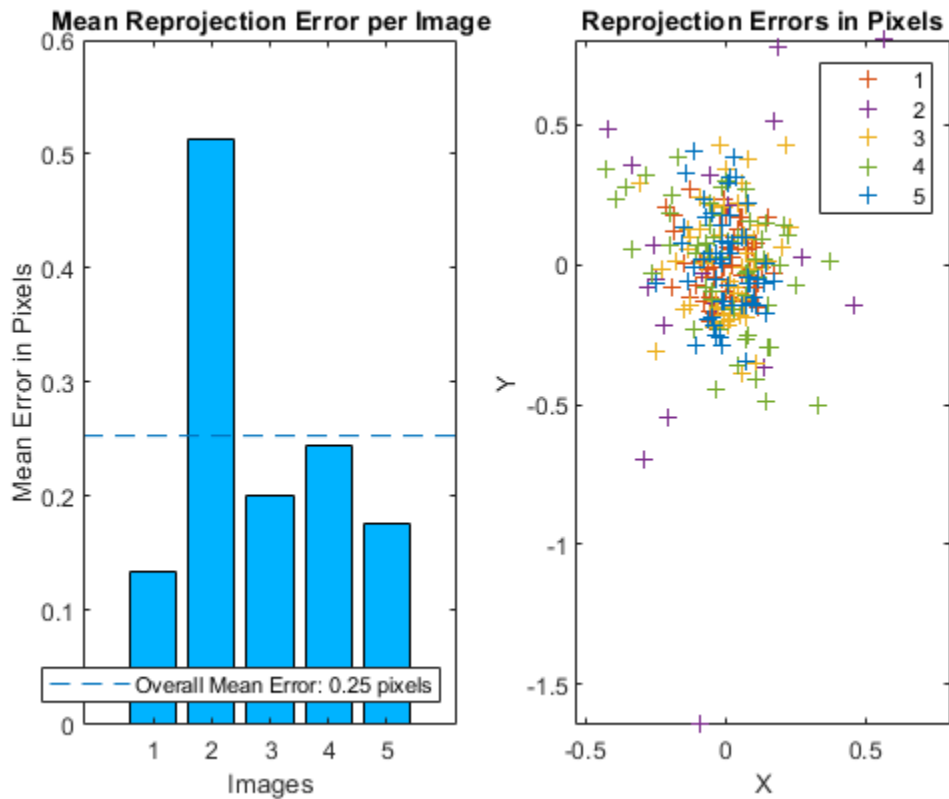

Visualize Reprojection Errors for a Stereo Pair of Cameras

Specify calibration images

```
imageDir = fullfile(toolboxdir('vision'),'visiondata', ...
    'calibration','stereo');
leftImages = imageDatastore(fullfile(imageDir,'left'));
rightImages = imageDatastore(fullfile(imageDir,'right'));
```

Detect the checkerboards.

```
[imagePoints, boardSize] = detectCheckerboardPoints(...
    leftImages.Files, rightImages.Files);
```

Specify world coordinates of checkerboard keypoints. The square size is in millimeters.

```
squareSize = 108;
worldPoints = generateCheckerboardPoints(boardSize, squareSize);
```

Calibrate the stereo camera system. Here both cameras have the same resolution.

```
I = readimage(leftImages,1);
imageSize = [size(I, 1), size(I, 2)];
params = estimateCameraParameters(imagePoints, worldPoints, ...
    'ImageSize', imageSize);
```

Visualize calibration accuracy.

```
showReprojectionErrors(params);
```

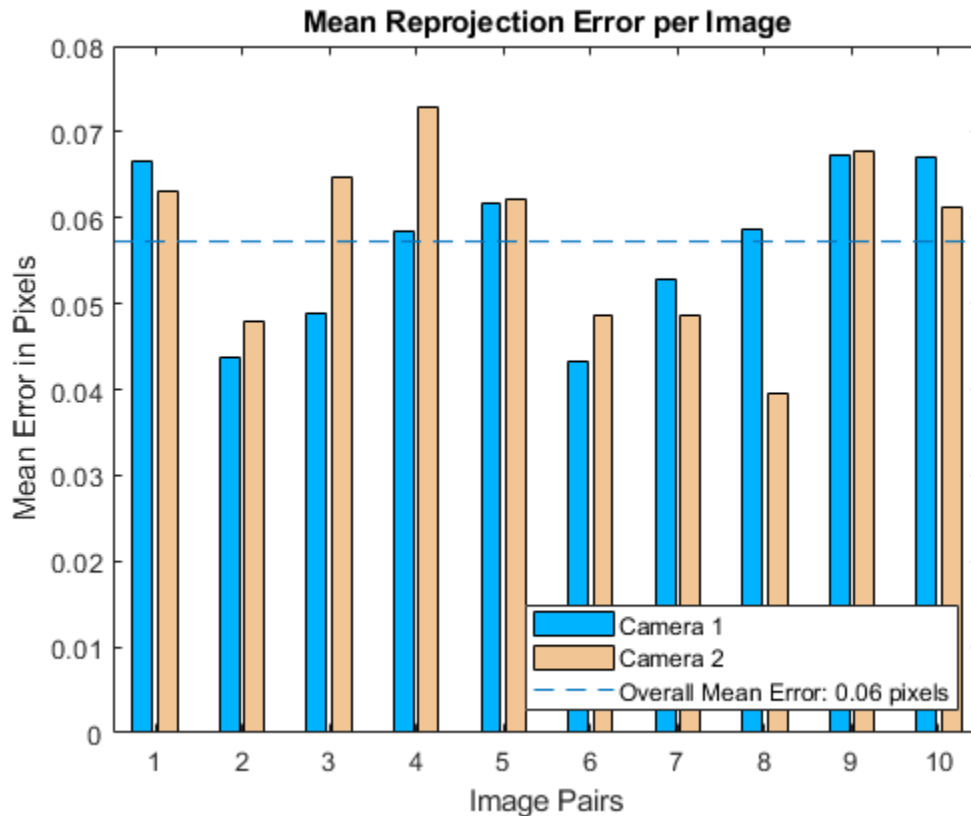

Input Arguments

cameraParams — Object containing parameters of single camera or stereo pair

cameraParameters object | fisheyeParameters object | stereoParameters object

Object containing parameters of single camera or stereo pair, specified as either a cameraParameters, fisheyeParameters, or stereoParameters object. You can create the single camera or stereo pair input object using the estimateCameraParameters function. The fisheye parameters input object is created using estimateFisheyeParameters.

You can also use the **Camera Calibrator** app to create the cameraParameters input object, or use **Stereo Camera Calibrator** app to create the stereoParameters input object. See “Using the Single Camera Calibrator App” and “Using the Stereo Camera Calibrator App”.

view — Bar graph or scatter plot view

'BarGraph' | 'ScatterPlot'

Bar graph or scatter plot view, specified as either 'BarGraph' or 'ScatterPlot'. The view input sets the visualization for the camera extrinsic parameters. Set view to 'BarGraph' to display the mean error per image as a bar graph. Set view to 'ScatterPlot' to display the error for each point as a scatter plot. The 'ScatterPlot' option applies only to the single camera case.

Name-Value Pair Arguments

Specify optional comma-separated pairs of `Name`, `Value` arguments. `Name` is the argument name and `Value` is the corresponding value. `Name` must appear inside quotes. You can specify several name and value pair arguments in any order as `Name1, Value1, ..., NameN, ValueN`.

Example: `'view', 'BarGraph'` displays the mean error per image as a bar graph.

HighlightIndex — Highlight selection index

`[]` (default) | vector of integers | scalar

Highlight selection index, specified as a scalar or a vector of integers. When you set the `view` to `'BarGraph'`, the function highlights the bars corresponding to the selected images. When you set the `view` to `'ScatterPlot'`, the function highlights the points corresponding to the selected images with circle markers.

Parent — Output axes

current axes (default) | scalar value

Output axes, specified as the comma-separated pair consisting of `'Parent'` and a scalar value. Specify output axes to display the visualization. You can obtain the current axes handle by returning the function to an output variable:

```
ax = showReprojectionErrors(cameraParams)
```

You can also use the `gca` function to get the current axes handle.

Example: `showReprojectionErrors(cameraParams, 'Parent', ax)`

Output Arguments

ax — Current axes handle

scalar value

Current axes handle, returned as a scalar value. The function returns the handle to the current axes for the current figure.

Example: `ax = showReprojectionErrors(cameraParams)`

See Also

[Camera Calibrator](#) | [Stereo Camera Calibrator](#) | [estimateCameraParameters](#) | [showExtrinsics](#) | [undistortImage](#) | [detectCheckerboardPoints](#) | [generateCheckerboardPoints](#) | [cameraParameters](#) | [stereoParameters](#) | [fisheyeParameters](#)

Topics

“Using the Single Camera Calibrator App”

Introduced in R2014a

stereoAnaglyph

Create red-cyan anaglyph from stereo pair of images

Syntax

```
J = stereoAnaglyph(I1,I2)
```

Description

`J = stereoAnaglyph(I1,I2)` combines images `I1` and `I2` into a red-cyan anaglyph. When the inputs are rectified stereo images, you can view the output image with red-blue stereo glasses to see the stereo effect.

Examples

Create 3-D Stereo Display

Load parameters for a calibrated stereo pair of cameras.

```
load('webcamsSceneReconstruction.mat')
```

Load a stereo pair of images.

```
I1 = imread('sceneReconstructionLeft.jpg');  
I2 = imread('sceneReconstructionRight.jpg');
```

Rectify the stereo images.

```
[J1, J2] = rectifyStereoImages(I1, I2, stereoParams);
```

Create the anaglyph.

```
A = stereoAnaglyph(J1, J2);
```

Display the anaglyph. Use red-blue stereo glasses to see the stereo effect.

```
figure; imshow(A);
```



Input Arguments

I1 — Input image

M-by-*N*-by-3 truecolor image | *M*-by-*N* 2-*D* grayscale image

Input image I1, specified as an *M*-by-*N*-by-3 truecolor image or an *M*-by-*N* 2-*D* grayscale image. I1 and I2 must be real, finite, and nonsparse, and the images must be the same size. If the images are not the same size, use `imfuse` to pad the smaller image dimension with zeros before creating the anaglyph.

Data Types: `single` | `double` | `int16` | `uint8` | `uint16` | `logical`

I2 — Input image

M-by-*N* 2-*D* grayscale image | *M*-by-*N*-by-3 truecolor image

Input image I2, specified as an *M*-by-*N*-by-3 truecolor image or an *M*-by-*N* 2-*D* grayscale image. I1 and I2 must be real, finite, and nonsparse, and the images must be the same size. If the images are not the same size, use `imfuse` to pad the smaller image dimension with zeros before creating the anaglyph.

Data Types: `single` | `double` | `int16` | `uint8` | `uint16` | `logical`

Output Arguments

J — Stereo anaglyph output image

M-by-*N*-by-3 truecolor image

Stereo anaglyph output image, returned as an *M*-by-*N*-by-3 truecolor image. Output image J is the same size as input images I1 and I2.

Data Types: `single` | `double` | `int16` | `uint8` | `uint16` | `logical`

Extended Capabilities

C/C++ Code Generation

Generate C and C++ code using MATLAB® Coder™.

See Also

`rectifyStereoImages` | `reconstructScene` | `estimateUncalibratedRectification` | `imfuse` | `imshowpair`

Topics

“Structure From Motion From Two Views”

“Structure From Motion From Multiple Views”

Introduced in R2014b

trainCascadeObjectDetector

Train cascade object detector model

Syntax

```
trainCascadeObjectDetector(outputXMLFilename,positiveInstances,  
negativeImages)
```

```
trainCascadeObjectDetector(outputXMLFilename,'resume')
```

```
trainCascadeObjectDetector( ___,Name,Value)
```

Description

`trainCascadeObjectDetector(outputXMLFilename,positiveInstances,negativeImages)` writes a trained cascade detector XML file named, `outputXMLFilename`. The file name must include an XML extension. For a more detailed explanation on how this function works, refer to “Get Started with Cascade Object Detector”.

`trainCascadeObjectDetector(outputXMLFilename,'resume')` resumes an interrupted training session. The `outputXMLFilename` input must match the output file name from the interrupted session. All arguments saved from the earlier session are reused automatically.

`trainCascadeObjectDetector(___,Name,Value)` uses additional options specified by one or more `Name,Value` pair arguments.

Examples

Train Stop Sign Detector

Load the positive samples data from a MAT file. The file contains a table specifying bounding boxes for several object categories. The table was exported from the Image Labeler app.

Load positive samples.

```
load('stopSignsAndCars.mat');
```

Select the bounding boxes for stop signs from the table.

```
positiveInstances = stopSignsAndCars(:,1:2);
```

Add the image folder to the MATLAB path.

```
imDir = fullfile(matlabroot,'toolbox','vision','visiondata',...  
    'stopSignImages');  
addpath(imDir);
```

Specify the folder for negative images.

```
negativeFolder = fullfile(matlabroot,'toolbox','vision','visiondata',...  
    'nonStopSigns');
```

Create an `imageDatastore` object containing negative images.

```
negativeImages = imageDatastore(negativeFolder);
```

Train a cascade object detector called 'stopSignDetector.xml' using HOG features. NOTE: The command can take several minutes to run.

```
trainCascadeObjectDetector('stopSignDetector.xml',positiveInstances, ...  
    negativeFolder,'FalseAlarmRate',0.1,'NumCascadeStages',5);
```

```
Automatically setting ObjectTrainingSize to [35, 32]
```

```
Using at most 42 of 42 positive samples per stage
```

```
Using at most 84 negative samples per stage
```

```
--cascadeParams--
```

```
Training stage 1 of 5
```

```
[.....]
```

```
Used 42 positive and 84 negative samples
```

```
Time to train stage 1: 0 seconds
```

```
Training stage 2 of 5
```

```
[.....]
```

```
Used 42 positive and 84 negative samples
```

```
Time to train stage 2: 0 seconds
```

```
Training stage 3 of 5
```

```
[.....]
```

```
Used 42 positive and 84 negative samples
```

```
Time to train stage 3: 2 seconds
```

```
Training stage 4 of 5
```

```
[.....]
```

```
Used 42 positive and 84 negative samples
```

```
Time to train stage 4: 6 seconds
```

```
Training stage 5 of 5
```

```
[.....]
```

```
Used 42 positive and 17 negative samples
```

```
Time to train stage 5: 9 seconds
```

```
Training complete
```

Use the newly trained classifier to detect a stop sign in an image.

```
detector = vision.CascadeObjectDetector('stopSignDetector.xml');
```

Read the test image.

```
img = imread('stopSignTest.jpg');
```

Detect a stop sign.

```
bbox = step(detector,img);
```

Insert bounding box rectangles and return the marked image.

```
detectedImg = insertObjectAnnotation(img,'rectangle',bbox,'stop sign');
```

Display the detected stop sign.

```
figure; imshow(detectedImg);
```



Remove the image directory from the path.

```
rmpath(imDir);
```

Input Arguments

positiveInstances — Positive samples

table | struct

Positive samples, specified as a two-column table or two-field structure.

The first table column or structure field contains image file names, specified as character vectors or string scalars. Each image can be true color, grayscale, or indexed, in any of the formats supported by `imread`.

The second table column or structure field contains an M -by-4 matrix of M bounding boxes. Each bounding box is in the format $[x\ y\ width\ height]$ and specifies an object location in the corresponding image.

You can use the **Image Labeler** or **Video Labeler** app to label objects of interest with bounding boxes. The app returns a `groundTruth` object. Use the `objectDetectorTrainingData` function to obtain a table from the object to use for `positiveInstances`. The function automatically determines the number of positive samples to use at each of the cascade stages. This value is based on the number of stages and the true positive rate. The true positive rate specifies how many positive samples can be misclassified.

Data Types: table | struct

negativeImages — Negative images

ImageDatastore object | cell array | character vector | string scalar

Negative images, specified as an `ImageDatastore` object, a path to a folder containing images, or as a cell array of image file names. Because the images are used to generate negative samples, they must not contain any objects of interest. Instead, they should contain backgrounds associated with the object.

outputXMLFilename — Trained cascade detector file name

character vector | string scalar

Trained cascade detector file name, specified as a character vector or a string scalar with an XML extension. For example, `'stopSignDetector.xml'`.

Data Types: char

Name-Value Pair Arguments

Specify optional comma-separated pairs of `Name`, `Value` arguments. `Name` is the argument name and `Value` is the corresponding value. `Name` must appear inside quotes. You can specify several name and value pair arguments in any order as `Name1, Value1, . . . , NameN, ValueN`.

Example: `'FeatureType', 'Haar'` specifies Haar for the type of features to use.

ObjectTrainingSize — Object size for training

'Auto' (default) | two-element vector

Training object size, specified as the comma-separated pair. This pair contains `'ObjectTrainingSize'` and either a two-element `[height, width]` vector, or as `'Auto'`. Before training, the function resizes the positive and negative samples to `ObjectTrainingSize` in pixels. If you select `'Auto'`, the function determines the size automatically based on the median width-to-height ratio of the positive instances. For optimal detection accuracy, specify an object training size close to the expected size of the object in the image. However, for faster training and detection, set the object training size to be smaller than the expected size of the object in the image.

Data Types: char | single | double | int8 | int16 | int32 | int64 | uint8 | uint16 | uint32 | uint64

NegativeSamplesFactor — Negative sample factor

2 (default) | real-valued scalar

Negative sample factor, specified as the comma-separated pair consisting of `'NegativeSamplesFactor'` and a real-valued scalar. The number of negative samples to use at each stage is equal to

`NegativeSamplesFactor` × *[the number of positive samples used at each stage]*.

Data Types: single | double | int8 | int16 | int32 | int64 | uint8 | uint16 | uint32 | uint64

NumCascadeStages — Number of cascade stages

20 (default) | positive integer

Number of cascade stages to train, specified as the comma-separated pair consisting of `'NumCascadeStages'` and a positive integer. Increasing the number of stages may result in a more accurate detector but also increases training time. More stages can require more training images, because at each stage, some number of positive and negative samples are eliminated. This value

depends on the values of `FalseAlarmRate` and `TruePositiveRate`. More stages can also enable you to increase the `FalseAlarmRate`. See the “Get Started with Cascade Object Detector” tutorial for more details.

Data Types: `single` | `double` | `int8` | `int16` | `int32` | `int64` | `uint8` | `uint16` | `uint32` | `uint64`

FalseAlarmRate — Acceptable false alarm rate

0.5 (default) | value in the range (0 1]

Acceptable false alarm rate at each stage, specified as the comma-separated pair consisting of 'FalseAlarmRate' and a value in the range (0 1]. The false alarm rate is the fraction of negative training samples incorrectly classified as positive samples.

The overall false alarm rate is calculated using the `FalseAlarmRate` per stage and the number of cascade stages, `NumCascadeStages`:

$$\text{FalseAlarmRate}^{\text{NumCascadeStages}}$$

Lower values for `FalseAlarmRate` increase complexity of each stage. Increased complexity can achieve fewer false detections but can result in longer training and detection times. Higher values for `FalseAlarmRate` can require a greater number of cascade stages to achieve reasonable detection accuracy.

Data Types: `single` | `double`

TruePositiveRate — Minimum true positive rate

0.995 (default) | value in the range (0,1]

Minimum true positive rate required at each stage, specified as the comma-separated pair consisting of 'TruePositiveRate' and a value in the range (0 1]. The true positive rate is the fraction of correctly classified positive training samples.

The overall resulting target positive rate is calculated using the `TruePositiveRate` per stage and the number of cascade stages, `NumCascadeStages`:

$$\text{TruePositiveRate}^{\text{NumCascadeStages}}$$

Higher values for `TruePositiveRate` increase complexity of each stage. Increased complexity can achieve a greater number of correct detections but can result in longer training and detection times.

Data Types: `single` | `double`

FeatureType — Feature type

'HOG' (default) | 'LBP' | 'Haar'

Feature type, specified as the comma-separated pair consisting of 'FeatureType' and one of the following:

- 'Haar'[1] — Haar-like features
- 'LBP'[2] — Local binary patterns
- 'HOG'[3] — Histogram of oriented gradients

The function allocates a large amount of memory, especially the Haar features. To avoid running out of memory, use this function on a 64-bit operating system with a sufficient amount of RAM.

Data Types: `char`

Tips

- Training a good detector requires thousands of training samples. Processing time for a large amount of data varies, but it is likely to take hours or even days. During training, the function displays the time it took to train each stage in the MATLAB command window.
- The OpenCV HOG parameters used in this function are:
 - Numbins: 9
 - CellSize = [8 8]
 - BlockSize = [4 4]
 - BlockOverlap = [2 2]
 - UseSignedOrientation = false

References

- [1] Viola, P., and M. J. Jones. "Rapid Object Detection using a Boosted Cascade of Simple Features." *Proceedings of the 2001 IEEE Computer Society Conference*. Volume 1, 15 April 2001, pp. I-511-I-518.
- [2] Ojala, T., M. Pietikainen, and T. Maenpaa. "Multiresolution Gray-scale and Rotation Invariant Texture Classification With Local Binary Patterns." *IEEE Transactions on Pattern Analysis and Machine Intelligence*. Volume 24, No. 7 July 2002, pp. 971-987.
- [3] Dalal, N., and B. Triggs. "Histograms of Oriented Gradients for Human Detection." *IEEE Computer Society Conference on Computer Vision and Pattern Recognition*. Volume 1, 2005, pp. 886-893.

See Also

Apps

[Image Labeler](#) | [Video Labeler](#)

Functions

[insertObjectAnnotation](#) | [imrect](#) | [vision.CascadeObjectDetector](#)

Topics

"Image Category Classification Using Bag of Features"

"Get Started with the Image Labeler"

"Get Started with Cascade Object Detector"

"Multiple Object Tracking"

External Websites

[Cascade Training GUI](#)

Introduced in R2013a

trainImageCategoryClassifier

Train an image category classifier

Syntax

```
classifier = trainImageCategoryClassifier(imds,bag)
classifier = trainImageCategoryClassifier(imds,bag,Name,Value)
```

Description

`classifier = trainImageCategoryClassifier(imds,bag)` returns an image category classifier. The classifier contains the number of categories and the category labels for the input `imds` images. The function trains a support vector machine (SVM) multiclass classifier using the input `bag`, a `bagOfFeatures` object.

You must have a Statistics and Machine Learning Toolbox license to use this function.

This function supports parallel computing using multiple MATLAB workers. Enable parallel computing using the “Computer Vision Toolbox Preferences” dialog. To open Computer Vision Toolbox preferences, on the **Home** tab, in the **Environment** section, click **Preferences**. Select Computer Vision Toolbox.

`classifier = trainImageCategoryClassifier(imds,bag,Name,Value)` returns a `classifier` object with optional input properties specified by one or more `Name,Value` pair arguments.

Examples

Train, Evaluate, and Apply Image Category Classifier

Load two image categories.

```
setDir = fullfile(toolboxdir('vision'),'visiondata','imageSets');
imds = imageDatastore(setDir,'IncludeSubfolders',true,'LabelSource',...
    'foldernames');
```

Split the data set into a training and test data. Pick 30% of images from each set for the training data and the remainder 70% for the test data.

```
[trainingSet,testSet] = splitEachLabel(imds,0.3,'randomize');
```

Create bag of visual words.

```
bag = bagOfFeatures(trainingSet);
```

Creating Bag-Of-Features.

```
-----
* Image category 1: books
* Image category 2: cups
* Selecting feature point locations using the Grid method.
```

```
* Extracting SURF features from the selected feature point locations.
** The GridStep is [8 8] and the BlockWidth is [32 64 96 128].

* Extracting features from 4 images...done. Extracted 76800 features.

* Keeping 80 percent of the strongest features from each category.

* Creating a 500 word visual vocabulary.
* Number of levels: 1
* Branching factor: 500
* Number of clustering steps: 1

* [Step 1/1] Clustering vocabulary level 1.
* Number of features      : 61440
* Number of clusters     : 500
* Initializing cluster centers...100.00%.
* Clustering...completed 20/100 iterations (~0.18 seconds/iteration)...converged in 20 iterations.

* Finished creating Bag-Of-Features
```

Train a classifier with the training sets.

```
categoryClassifier = trainImageCategoryClassifier(trainingSet,bag);
```

```
Training an image category classifier for 2 categories.
```

```
-----
* Category 1: books
* Category 2: cups

* Encoding features for 4 images...done.

* Finished training the category classifier. Use evaluate to test the classifier on a test set.
```

Evaluate the classifier using test images. Display the confusion matrix.

```
confMatrix = evaluate(categoryClassifier,testSet)
```

```
Evaluating image category classifier for 2 categories.
```

```
-----
* Category 1: books
* Category 2: cups

* Evaluating 8 images...done.

* Finished evaluating all the test sets.

* The confusion matrix for this test set is:
```

KNOWN	PREDICTED	
	books	cups
books	0.75	0.25
cups	0.25	0.75

```
* Average Accuracy is 0.75.
```



```
confMatrix = 2x2
    0.7500    0.2500
    0.2500    0.7500
```

Find the average accuracy of the classification.

```
mean(diag(confMatrix))
ans = 0.7500
```

Apply the newly trained classifier to categorize new images.

```
img = imread(fullfile(setDir, 'cups', 'bigMug.jpg'));
[labelIdx, score] = predict(categoryClassifier, img);
```

```
Encoding images using Bag-Of-Features.
-----
* Encoding an image...done.
```

Display the classification label.

```
categoryClassifier.Labels(labelIdx)
ans = 1x1 cell array
    {'cups'}
```

Input Arguments

imds — Images

imageDatastore object

Images specified as an imageDatastore object.

bag — Bag of features

bagOfFeatures object

Bag of features, specified as a bagOfFeatures object. The object contains a visual vocabulary of extracted feature descriptors from representative images of each image category.

Name-Value Pair Arguments

Specify optional comma-separated pairs of **Name**, **Value** arguments. **Name** is the argument name and **Value** is the corresponding value. **Name** must appear inside quotes. You can specify several name and value pair arguments in any order as **Name1**, **Value1**, ..., **NameN**, **ValueN**.

Example: 'Verbose', true sets 'Verbose' to the logical true.

Verbose — Enable progress display to screen

true (default) | false

Enable progress display to screen, specified as the comma-separated pair consisting of 'Verbose' and the logical true or false.

LearnerOptions – Classifier options

default values of `templateSVM` function

Classifier options, specified as the comma-separated pair consisting of 'LearnerOptions' and the learner options output returned by the `templateSVM` function.

Example 3.2. Example

To adjust the regularization parameter of `templateSVM` and to set a custom kernel function, use the following syntax:

```
opts = templateSVM('BoxConstraint',1.1,'KernelFunction','gaussian');  
classifier = trainImageCategoryClassifier(imds,bag,'LearnerOptions',opts);
```

Output Arguments

classifier – Image category classifier

`imageCategoryClassifier` object

Image category classifier, returned as an `imageCategoryClassifier` object. The function trains a support vector machine (SVM) multiclass classifier using the error correcting output codes (ECOC) framework.

References

- [1] Csurka, G., C. R. Dance, L. Fan, J. Willamowski, and C. Bray *Visual Categorization with Bag of Keypoints*, Workshop on Statistical Learning in Computer Vision, ECCV 1 (1-22), 1-2.

Extended Capabilities

Automatic Parallel Support

Accelerate code by automatically running computation in parallel using Parallel Computing Toolbox™.

To run in parallel, set 'UseParallel' to true or enable this by default using the Computer Vision Toolbox preferences.

For more information, see “Parallel Computing Toolbox Support”.

See Also

`imageSet` | `bagOfFeatures` | `imageCategoryClassifier` | `fitcecoc` | `templateSVM`

Topics

“Image Category Classification Using Bag of Features”

“Image Classification with Bag of Visual Words”

Introduced in R2014b

Image Labeler

Label images for computer vision applications

Description

The **Image Labeler** app enables you to label ground truth data in a collection of images. Using the app, you can:

- Define rectangular regions of interest (ROI) labels, polyline ROI labels, pixel ROI labels, polygon ROI labels, and scene labels. Use these labels to interactively label your ground truth data.
- Use built-in detection or tracking algorithms to label your ground truth data.
- Write, import, and use your own custom automation algorithm to automatically label ground truth. See “Create Automation Algorithm for Labeling”.
- Evaluate the performance of your label automation algorithms using a visual summary. See “View Summary of Ground Truth Labels”.
- Export the labeled ground truth as a `groundTruth` object. You can use this object for system verification or for training an object detector or semantic segmentation network. See “Training Data for Object Detection and Semantic Segmentation”.

The **Image Labeler** app supports all image file formats supported by the `imread` function and additionally supports the Digital Imaging and Communication in Medicine (DICOM) format. To read additional file formats, you can create an `imageDatastore` and use the `ReadFcn` property.

When loading images, if an image has a dimension larger than 8000 pixels or is a multiresolution image, the **Image Labeler** app offers you the option to convert the image into a blocked image. A *blocked image* consists of a large image that has been divided into smaller blocks that can fit in memory. Once the Image Labeler converts the large image into a blocked, you can process it in the app as you would any other image. While using blocked images enables you to process images in the app that you might not otherwise be able to, there are some limitations. For more information, see “Label Large Images in the Image Labeler”.

To learn more about this app, see “Get Started with the Image Labeler”.

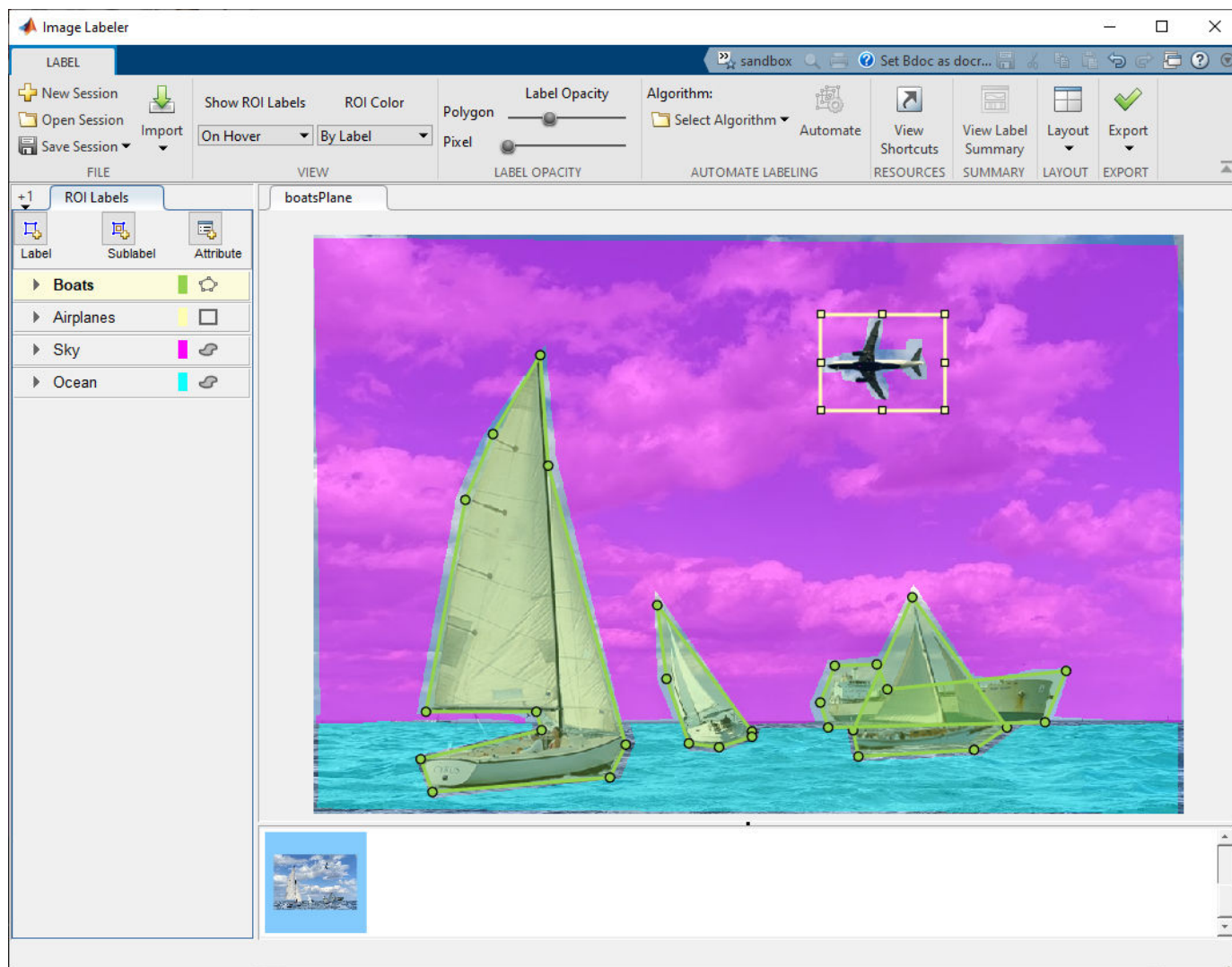

Open the Image Labeler App

- MATLAB Toolstrip: On the **Apps** tab, under **Image Processing and Computer Vision**, click the app icon.
- MATLAB command prompt: Enter `imageLabeler`.

Programmatic Use

`imageLabeler` opens a new session of the app, enabling you to label ground truth data in images.

`imageLabeler(imageFolder)` opens the app and loads all the images from the folder named `imageFolder`.

The images in the folder can be unordered and can vary in size. To label a video, or a set of ordered images that resemble a video, use the **Video Labeler** app instead.

`imageLabeler(imageDatastore)` opens the app and reads all of the images from an `imageDatastore` object. The `ReadFcn` property of the `imageDatastore` object specifies how to read the data.

For example, to open the app with a collection of stop sign images:

```
stopSignsFolder = fullfile(toolboxdir('vision'),'visiondata','stopSignImages');
imds = imageDatastore(stopSignsFolder)
imageLabeler(imds)
```

`imageLabeler(sessionFile)` opens the app and loads a saved **Image Labeler** session, `sessionFile`. The `sessionFile` input contains the path and file name. The MAT-file that `sessionFile` points to contains the saved session.

`imageLabeler(gTruth)` opens the app and loads a `groundTruth` object. The ground truth object data source must be an image collection or an `imageDatastore`.

More About

ROI Labels, Sublabels, and Attributes

On the left side of the app, the **ROI Labels** pane contains the region of interest (ROI) label definitions that you can mark on the frames. You can create label definitions directly from this pane. Alternatively, you can create label definitions programmatically by using a `labelDefinitionCreator` object and then import these label definitions into an app session.

Selecting ROI Label and Drawing Tool for Your Application

You can use labeled data to validate or train algorithms such as image classifiers, object detectors, and semantic and instance segmentation networks. Consider your application when choosing a labeling drawing tool to create ROI labels. The figure below shows labeling techniques for four different applications.

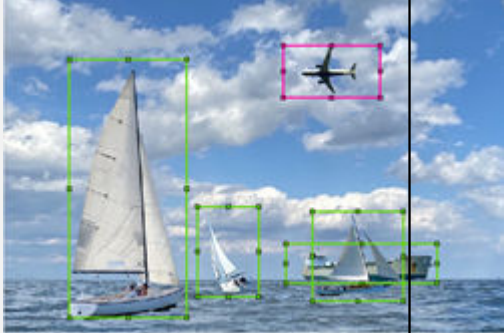
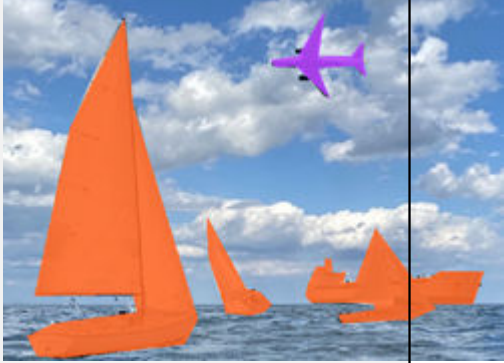
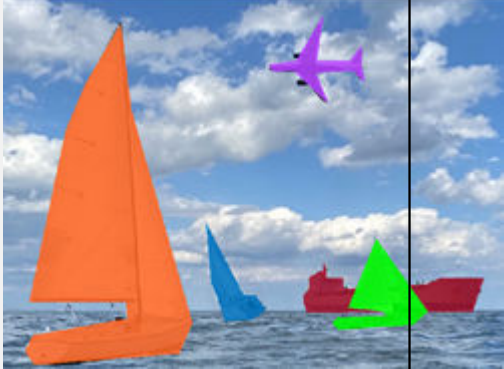

Application	Label Types	Example
Image Classification	N/A	 <p>Boat, Plane</p>

Application	Label Types	Example
Object Detection	Line Rectangle Projected Rectangle	
Semantic Segmentation	Pixel label Polygon	
Instance Segmentation	Polygon	

ROI Labels

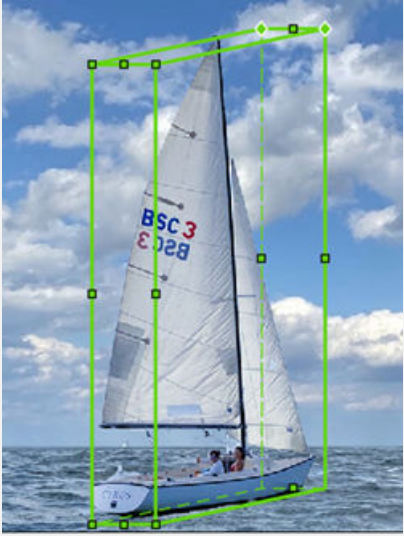
An ROI label is a label that corresponds to a region of interest (ROI) in a signal frame. The table describes the supported label types.

ROI Label	Description	Scene
Rectangle	Draw rectangular ROI labels (bounding boxes) around objects.	 A photograph of a white sailboat with a large white sail on a blue sea under a blue sky with white clouds. A green rectangular bounding box is drawn around the entire sailboat, including the mast and the sail.
Projected cuboid	Draw cuboidal ROI labels (3-D bounding boxes).	 A photograph of a white sailboat with a large white sail on a blue sea under a blue sky with white clouds. The sail has the text 'BSC3' written on it. A green 3-D bounding box is drawn around the sailboat, showing depth with lines extending from the corners of the 2D box.

ROI Label	Description	Scene
Line	<p>Draw linear ROI labels to represent lines. To draw a polyline ROI, use two or more points.</p>	
Pixel label	<p>Assign labels to pixels for semantic segmentation. You can label pixels manually using polygons, brushes, or flood fill. For more information about pixel labeling, see “Label Pixels for Semantic Segmentation”.</p>	

ROI Label	Description	Scene
Polygon	Draw a pixel-filled polygon for instance segmentation. You can label distinct instances of the same class. For more information about instance segmentation, see “Label Objects Using Polygons”	

ROI Sublabels

An ROI sublabel is an ROI label that belongs to a parent label. Use ROI sublabels to provide a greater level of detail about the ROIs in your labeled ground truth data. For example, a **vehicle** label might contain **headlight**, **licensePlate**, and **wheel** sublabels. You can create sublabels only for rectangular and polyline labels. For more details about sublabels, see “Use Sublabels and Attributes to Label Ground Truth Data”.

ROI Attributes

An ROI attribute specifies additional information about an ROI label or sublabel. For example, in an ocean scene, attributes might include the type or color of a boat. The table describes the supported attribute types.

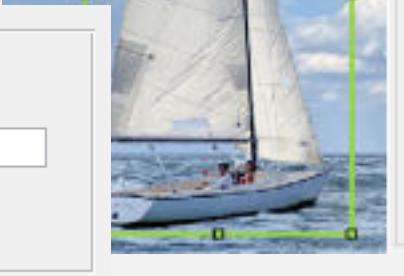
Attribute Type	Sample Attribute Definition	Sample Default Values
Numeric Value	Attributes numSails <input type="text" value="2"/>	
String	Attributes boatColor <input type="text" value="white"/>	

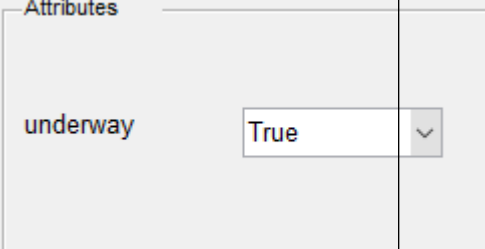
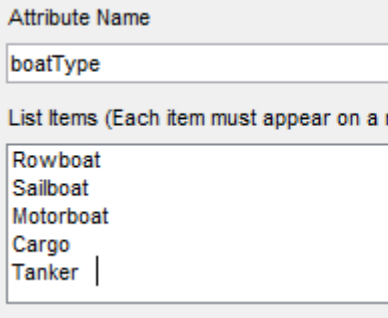
Attribute Type	Sample Attribute Definition	Sample Default Values
Logical		
List		

For more details about attributes, see “Use Sublabels and Attributes to Label Ground Truth Data”.

Algorithms

You can use label automation algorithms to speed up labeling within the app. To create your own label automation algorithm to use within the app, see “Create Automation Algorithm for Labeling”. You can also use one of the built-in algorithms by following these steps:

- 1 Import the data you want to label, and create at least one label definition.
- 2 On the app toolstrip, click **Select Algorithm** and select one of the built-in automation algorithms.
- 3 Click **Automate**, and then follow the automation instructions in the right pane of the automation window.

ACF People Detector

Detect and label people using aggregate channel features (ACF). This algorithm is based on the `peopleDetectorACF` function. To use this algorithm, you must define at least one rectangle ROI label. You do not need to draw any ROI labels.

To help improve the algorithm results, first click **Settings**. You can change any of these settings.

- The pretrained people detector model that the algorithm uses — The 'inria-100x41' model was trained using the INRIA person data set. The 'caltech-50x21' model was trained using the Caltech Pedestrian data set.
- The overlap ratio threshold, from 0 to 1, for detecting people — When rectangle ROIs overlap by more than this threshold, the algorithm discards one of the ROIs.
- The classification score threshold for detecting people — Increase the score to increase the prediction confidence of the algorithm. Rectangles with scores below this threshold are discarded.

ACF Vehicle Detector (requires Automated Driving Toolbox)

Detect and label vehicles using aggregate channel features (ACF). This algorithm is based on the `vehicleDetectorACF` function. To use this algorithm, you must define at least one rectangle ROI label. You do not need to draw any ROI labels.

To help improve the algorithm results, first click **Settings**. You can change any of these settings.

- The pretrained vehicle detector model that the algorithm uses — The 'full-view' model was trained using unoccluded images of the front, rear, left, and right sides of vehicles. The 'front-rear-view' model was trained using images of only the front and rear sides of the vehicle.
- The overlap ratio threshold, from 0 to 1, for detecting vehicles — When rectangle ROIs overlap by more than this threshold, the algorithm discards one of the ROIs.
- The classification score threshold for detecting vehicles — Increase the score to increase the prediction confidence of the algorithm. Rectangles with scores below this threshold are discarded.

You can also configure the detector with a calibrated monocular camera by importing a `monoCamera` object into the MATLAB workspace. Specify the length and width ranges of the vehicle in world units, such as meters.

See Also

Apps

[Video Labeler](#) | [Ground Truth Labeler](#) | [Lidar Labeler](#)

Functions

[pixelLabelTrainingData](#) | [objectDetectorTrainingData](#) | [polyToBlockedImage](#)

Objects

[groundTruth](#) | [groundTruthDataSource](#) | [labelDefinitionCreator](#)

Topics

[“Choose an App to Label Ground Truth Data”](#)

[“Get Started with the Image Labeler”](#)

[“Label Objects Using Polygons”](#)

[“Label Pixels for Semantic Segmentation”](#)

[“Share and Store Labeled Ground Truth Data”](#)

[“Create Automation Algorithm for Labeling”](#)

[“Keyboard Shortcuts and Mouse Actions for Image Labeler”](#)

[“Training Data for Object Detection and Semantic Segmentation”](#)

[“Convert Image Labeler Polygons to Labeled Blocked Image for Semantic Segmentation”](#)

Introduced in R2018a

Video Labeler

Label video for computer vision applications

Description

The **Video Labeler** app enables you to label ground truth data in a video, in an image sequence, or from a custom data source reader. Using the app, you can:

- Define rectangular regions of interest (ROI) labels, polyline ROI labels, pixel ROI labels, and scene labels. Use these labels to interactively label your ground truth data.
- Use built-in detection or tracking algorithms to label your ground truth data.
- Write, import, and use your own custom automation algorithm to automatically label ground truth. See “Create Automation Algorithm for Labeling”.
- Evaluate the performance of your label automation algorithms using a visual summary. See “View Summary of Ground Truth Labels”.
- Export the labeled ground truth as a `groundTruth` object. You can use this object for system verification or for training an object detector or semantic segmentation network. See “Training Data for Object Detection and Semantic Segmentation”.

To learn more about this app, see “Get Started with the Video Labeler”.

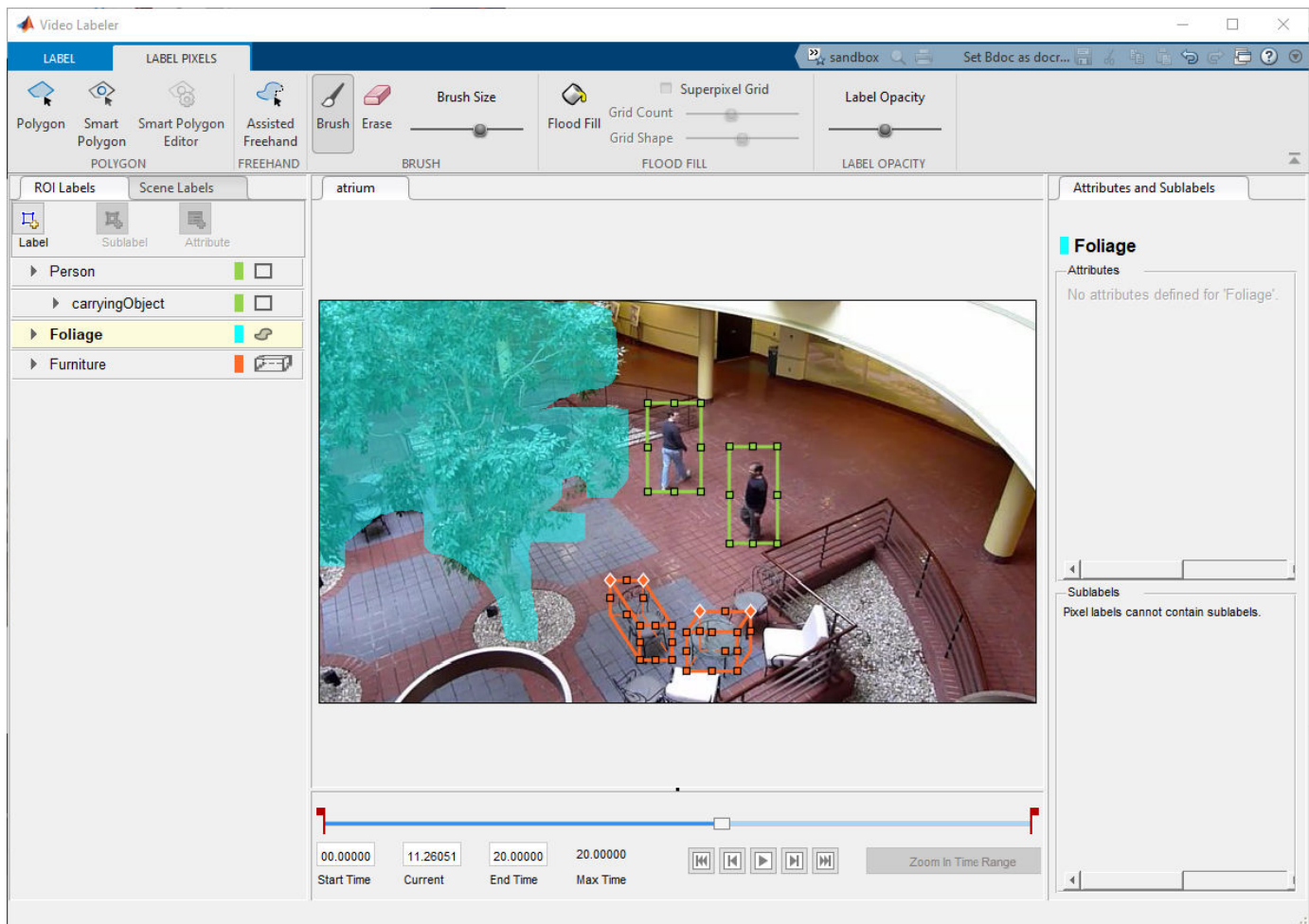

Open the Video Labeler App

- MATLAB Toolstrip: On the **Apps** tab, under **Image Processing and Computer Vision**, click the app icon.
- MATLAB command prompt: Enter `videoLabeler`.

Examples

- “Get Started with the Video Labeler”

Programmatic Use

`videoLabeler` opens a new session of the app, enabling you to label ground truth data in a video or image sequence.

`videoLabeler(videoFileName)` opens the app and loads the input video. The video file must have an extension supported by `VideoReader`.

Example: `videoLabeler('vipmen.avi')`

`videoLabeler(imageSeqFolder)` opens the app and loads the image sequence from the input folder. An image sequence is an ordered set of images that resemble a video.

`imageSeqFolder` must be a string scalar or character vector that specifies the folder containing the image files. The image files must have extensions supported by `imformats` and are loaded in the order returned by the `dir` function.

`videoLabeler(imageSeqFolder,timestamps)` opens the app and loads a sequence of images with their corresponding timestamps. `timestamps` must be a duration vector of the same length as the number of images in the sequence.

For example, load a sequence of images and their corresponding timestamps into the app.

```
imageDir = fullfile(toolboxdir('vision'),'visiondata','NewTsukuba');
timeStamps = seconds(1:150);
videoLabeler(imageDir,timeStamps)
```

`videoLabeler(gtSource)` opens the app and loads the data source and corresponding timestamps from a `groundTruthDataSource` object, `gtSource`. To generate this object for a custom data source, you can specify a custom reader function. For details, see “Use Custom Image Source Reader for Labeling”.

`videoLabeler(sessionFile)` opens the app and loads a saved app session, `sessionFile`. The `sessionFile` input contains the path and file name. The MAT-file that `sessionFile` points to contains the saved session.

`videoLabeler(gTruth)` opens the app and loads a `groundTruth` object. You do not need to add a video before loading the object. The ground truth object data source must be an image sequence, video, or a custom data source.

Limitations

- The built-in automation algorithms support the automation of rectangular ROI labels only. When you select a built-in algorithm and click **Automate**, scene labels, pixel ROI labels, polyline ROI labels, sublabels, and attributes are not imported into the automation session. To automate the labeling of these features, create a custom automation algorithm. See “Create Automation Algorithm for Labeling”.
- Pixel ROI labels do not support sublabels or attributes.
- The Label Summary window does not support sublabels or attributes

More About

ROI Labels, Sublabels, and Attributes

On the left side of the app, the **ROI Labels** pane contains the region of interest (ROI) label definitions that you can mark on the frames. You can create label definitions directly from this pane. Alternatively, you can create label definitions programmatically by using a `labelDefinitionCreator` object and then import these label definitions into an app session.

The app supports the definition of ROI labels, sublabels, and attributes.

Selecting ROI Label and Drawing Tool for Your Application

You can use labeled data to validate or train algorithms such as image classifiers, object detectors, and semantic and instance segmentation networks. Consider your application when choosing a labeling drawing tool to create ROI labels. The figure below shows labeling techniques for four different applications.

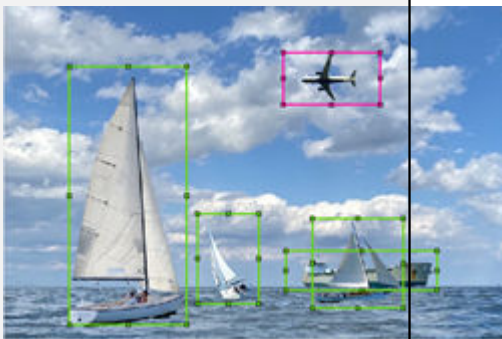
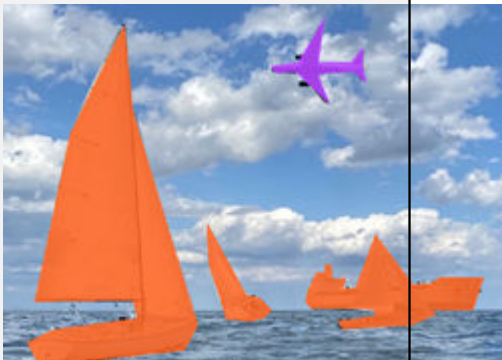

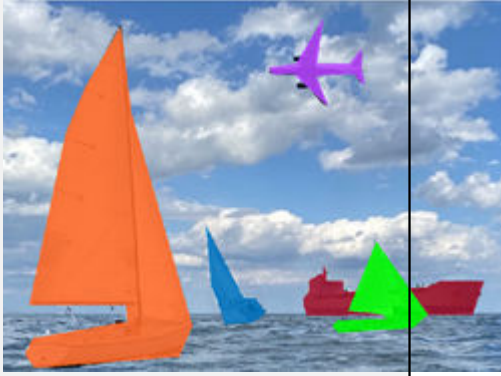
Application	Label Types	Example
Image Classification	N/A	 <p data-bbox="1062 873 1203 905">Boat, Plane</p>
Object Detection	Line Rectangle Projected Rectangle	
Semantic Segmentation	Pixel label Polygon	

Application	Label Types	Example
Instance Segmentation	Polygon	

ROI Labels

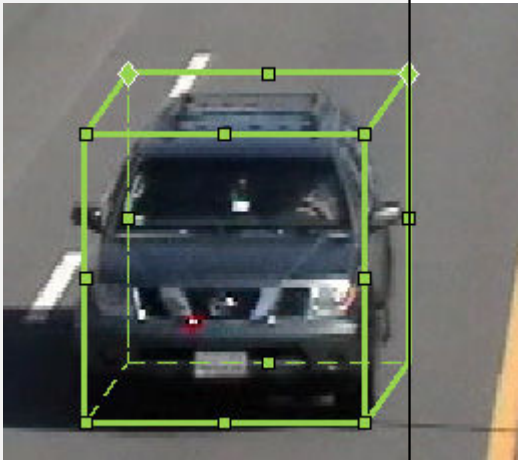
An ROI label is a label that corresponds to a region of interest (ROI) in a signal frame. The table describes the supported label types.

ROI Label	Description	Scene
Rectangle	Draw rectangular ROI labels (bounding boxes) around objects.	Vehicles, pedestrians, road signs 
Projected cuboid	Draw cuboidal ROI labels (3-D bounding boxes).	

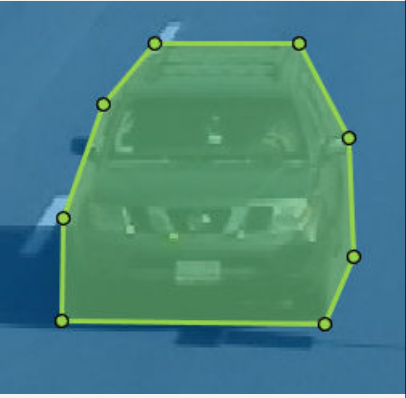
ROI Label	Description	Scene
Line	Draw linear ROI labels to represent lines. To draw a polyline ROI, use two or more points.	Lane boundaries, guard rails, road curbs 
Pixel label	Assign labels to pixels for semantic segmentation. You can label pixels manually using polygons, brushes, or flood fill. For more on pixel labeling, see “Label Pixels for Semantic Segmentation”.	Vehicles, road surface, trees, pavement 
Polygon	Draw polygon ROI labels. You can label distinct instances of the same class. For more information on drawing polygon ROI labels for instance and semantic segmentation networks, see “Label Objects Using Polygons”	Vehicles, road surface, trees, pavement 





ROI Sublabels

An ROI sublabel is an ROI label that belongs to a parent label. Use ROI sublabels to provide a greater level of detail about the ROIs in your labeled ground truth data. For example, a **vehicle** label might contain **headlight**, **licensePlate**, and **wheel** sublabels. You can create sublabels only for rectangular

and polyline labels. For more details about sublabels, see “Use Sublabels and Attributes to Label Ground Truth Data”.

ROI Attributes

An ROI attribute specifies additional information about an ROI label or sublabel. For example, in a driving scene, attributes might include the type or color of a vehicle. The table describes the supported attribute types.

Attribute Type	Sample Attribute Definition	Sample Default Values
Numeric Value	Attribute Name <input type="text" value="numDoors"/> Default Scalar Value (Optional) <input type="text" value="4"/>	
String	Attribute Name <input type="text" value="color"/> Default Value (Optional) <input type="text"/>	
Logical	Attribute Name <input type="text" value="inMotion"/> Default Value (Optional) <input type="text" value="True"/>	
List	Attribute Name <input type="text" value="carType"/> List Items (Each item must appear on a new line) <input type="text" value="Sedan"/> <input type="text" value="Hatchback"/> <input type="text" value="Wagon"/>	

For more details about attributes, see “Use Sublabels and Attributes to Label Ground Truth Data”.

Tips

- To avoid having to relabel ground truth with new labels, organize the labeling scheme you want to use before marking your ground truth.

Algorithms

You can use label automation algorithms to speed up labeling within the app. To create your own label automation algorithm to use within the app, see “Create Automation Algorithm for Labeling”. You can also use one of the built-in algorithms by following these steps:

- 1 Import the data you want to label, and create at least one label definition.
- 2 On the app toolstrip, click **Select Algorithm** and select one of the built-in automation algorithms.
- 3 Click **Automate**, and then follow the automation instructions in the right pane of the automation window.

ACF People Detector

Detect and label people using aggregate channel features (ACF). This algorithm is based on the `peopleDetectorACF` function. To use this algorithm, you must define at least one rectangle ROI label. You do not need to draw any ROI labels.

To help improve the algorithm results, first click **Settings**. You can change any of these settings.

- The pretrained people detector model that the algorithm uses — The 'inria-100x41' model was trained using the INRIA person data set. The 'caltech-50x21' model was trained using the Caltech Pedestrian data set.
- The overlap ratio threshold, from 0 to 1, for detecting people — When rectangle ROIs overlap by more than this threshold, the algorithm discards one of the ROIs.
- The classification score threshold for detecting people — Increase the score to increase the prediction confidence of the algorithm. Rectangles with scores below this threshold are discarded.

Point Tracker

Track and label one or more rectangle ROI labels over short intervals by using the Kanade-Lucas-Tomasi (KLT) algorithm. This algorithm is based on the `vision.PointTracker` System object. To use this algorithm, you must define at least one rectangle ROI label, but you do not need to draw any ROI labels.

To change the feature detector used to obtain the initial points for tracking, click **Settings**. This table shows the feature detector options.

Feature Detector	Description	Equivalent Function
Minimum Eigen Value	Detect corners by using the minimum eigenvalue algorithm.	<code>detectMinEigenFeatures</code>
Harris	Detect corners by using the Harris-Stephens algorithm.	<code>detectHarrisFeatures</code>

Feature Detector	Description	Equivalent Function
FAST	Detect corners by using the features from accelerated segment test (FAST) algorithm.	detectFASTFeatures
BRISK	Detect features by using the binary robust invariant scalable keypoints (BRISK) algorithm.	detectBRISKFeatures
KAZE	Detect features by using nonlinear diffusion to construct a scale space of an image, and then detecting multiscale corner features (KAZE features) from that scale space.	detectKAZEFeatures
SURF	Detect blob features by using the speeded-up robust features (SURF) algorithm.	detectSURFFeatures
MSER	Detect regions by using the maximally stable extremal regions (MSER) algorithm.	detectMSERFeatures

Temporal Interpolator

Estimate rectangle ROIs between frames by interpolating the ROI locations across the time range. To use this algorithm, you must draw a rectangle ROI on a minimum of two frames: one at the beginning of the interval and one at the end of the interval. The interpolation algorithm estimates and draws ROIs in the intermediate frames.

Consider a video with 10 frames. The first frame has a rectangle ROI centered at [5, 5]. The 10th frame has a rectangle ROI centered at [25, 25]. At each frame, the algorithm moves the ROI 2 pixels in the x-direction and 2 pixels in the y-direction. Therefore, the algorithm centers the ROI at [7, 7] in the second frame, [9, 9] in the third frame, and so on, up to [23, 23] in the second-to-last frame.

ACF Vehicle Detector (requires Automated Driving Toolbox)

Detect and label vehicles using aggregate channel features (ACF). This algorithm is based on the `vehicleDetectorACF` function. To use this algorithm, you must define at least one rectangle ROI label. You do not need to draw any ROI labels.

To help improve the algorithm results, first click **Settings**. You can change any of these settings.

- The pretrained vehicle detector model that the algorithm uses — The 'full-view' model was trained using unoccluded images of the front, rear, left, and right sides of vehicles. The 'front-rear-view' model was trained using images of only the front and rear sides of the vehicle.
- The overlap ratio threshold, from 0 to 1, for detecting vehicles — When rectangle ROIs overlap by more than this threshold, the algorithm discards one of the ROIs.
- The classification score threshold for detecting vehicles — Increase the score to increase the prediction confidence of the algorithm. Rectangles with scores below this threshold are discarded.

You can also configure the detector with a calibrated monocular camera by importing a `monoCamera` object into the MATLAB workspace. Specify the length and width ranges of the vehicle in world units, such as meters.

Lane Boundary Detector (requires Automated Driving Toolbox)

Detect and label lane boundaries using an estimated bird's-eye-view projected image. To use this algorithm, you must define at least one line ROI label. You do not need to draw any ROI labels. To detect lane boundaries, the algorithm follows these steps:

- 1 It makes an initial guess at the placement of the lane boundaries in the image.
- 2 It transforms the ROI around the lanes into a bird's-eye view image to make the lanes parallel and remove distortion.
- 3 It uses this image to segment the lane boundaries.

To help improve the algorithm results, first click **Settings**. You can change any of these settings.

- The placement of the lane lines for generating the bird's-eye view image
- The ROI around the lanes, which you can expand to include more than just the ego lane boundaries in the image
- The pixel width of detected lane boundaries in the image

You can also change the number of lane boundaries that you want to detect. The default number of lane boundaries is 2.

See Also

Apps

[Image Labeler](#) | [Ground Truth Labeler](#) | [Lidar Labeler](#)

Functions

[objectDetectorTrainingData](#) | [pixelLabelTrainingData](#)

Objects

[groundTruth](#) | [groundTruthDataSource](#) | [labelDefinitionCreator](#)

Topics

["Get Started with the Video Labeler"](#)

["Choose an App to Label Ground Truth Data"](#)

["Use Custom Image Source Reader for Labeling"](#)

["Use Sublabels and Attributes to Label Ground Truth Data"](#)

["Label Pixels for Semantic Segmentation"](#)

["Label Objects Using Polygons"](#)

["Create Automation Algorithm for Labeling"](#)

["Share and Store Labeled Ground Truth Data"](#)

["Keyboard Shortcuts and Mouse Actions for Video Labeler"](#)

["Training Data for Object Detection and Semantic Segmentation"](#)

Introduced in R2018b

Training Image Labeler

Label images for training a classifier

Description

The **Image Labeler** app replaces the **Training Image Labeler** app. Use the Image Labeler instead.

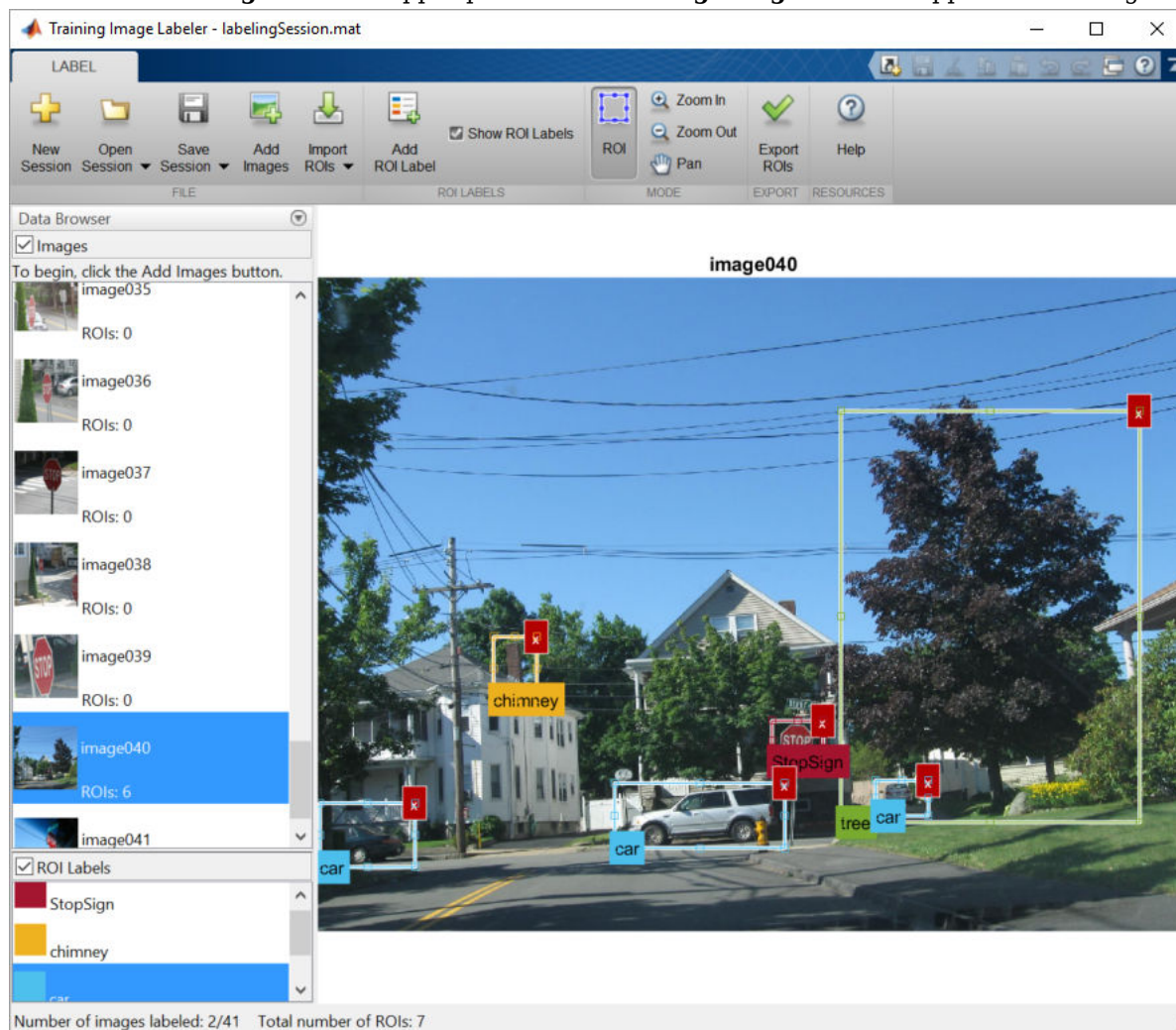

Open the Training Image Labeler App

- MATLAB command prompt: Enter `trainingImageLabeler`.

Note The `trainingImageLabeler` function opens the **Image Labeler** app.

Examples

Open Training Image Labeler App

Type `trainingImageLabeler` on the MATLAB command line or select it from the MATLAB desktop **Apps** tab.

Note The `trainingImageLabeler` function opens the **Image Labeler** app.

Programmatic Use

`trainingImageLabeler` invokes an app for labeling ground truth data in images. This app allows you to interactively specify rectangular Regions of Interest (ROIs). The ROIs define locations of objects, which are used to train a classifier. It outputs training data in a format supported by the `trainCascadeObjectDetector` function. The function trains a model to use with the `vision.CascadeObjectDetector` detector.

Note The `trainingImageLabeler` function opens the **Image Labeler** app.

See Also

Image Labeler | `insertObjectAnnotation` | `imrect` | `trainCascadeObjectDetector` | `vision.CascadeObjectDetector` | `imageDatastore`

Topics

“Get Started with the Image Labeler”
“Get Started with Cascade Object Detector”

Introduced in R2014a

triangulate

3-D locations of undistorted matching points in stereo images

Syntax

```
worldPoints = triangulate(matchedPoints1,matchedPoints2,stereoParams)
worldPoints = triangulate(matchedPoints1,matchedPoints2,cameraMatrix1,
cameraMatrix2)
[worldPoints,reprojectionErrors] = triangulate(___)
[worldPoints,reprojectionErrors,validIndex] = triangulate(___)
```

Description

`worldPoints = triangulate(matchedPoints1,matchedPoints2,stereoParams)` returns the 3-D locations of matching pairs of undistorted image points from two stereo images.

`worldPoints = triangulate(matchedPoints1,matchedPoints2,cameraMatrix1,cameraMatrix2)` returns the 3-D locations of the matching pairs in a world coordinate system. These locations are defined by camera projection matrices.

`[worldPoints,reprojectionErrors] = triangulate(___)` additionally returns reprojection errors for the world points using any of the input arguments from previous syntaxes.

`[worldPoints,reprojectionErrors,validIndex] = triangulate(___)` additionally returns the indices of valid and invalid world points. Valid points are located in front of the cameras.

Examples

Measure Distance from Stereo Camera to a Face

Load stereo parameters.

```
load('webcamsSceneReconstruction.mat');
```

Read in the stereo pair of images.

```
I1 = imread('sceneReconstructionLeft.jpg');
I2 = imread('sceneReconstructionRight.jpg');
```

Undistort the images.

```
I1 = undistortImage(I1,stereoParams.CameraParameters1);
I2 = undistortImage(I2,stereoParams.CameraParameters2);
```

Detect a face in both images.

```
faceDetector = vision.CascadeObjectDetector;
face1 = faceDetector(I1);
face2 = faceDetector(I2);
```

Find the center of the face.

```
center1 = face1(1:2) + face1(3:4)/2;
center2 = face2(1:2) + face2(3:4)/2;
```

Compute the distance from camera 1 to the face.

```
point3d = triangulate(center1, center2, stereoParams);
distanceInMeters = norm(point3d)/1000;
```

Display the detected face and distance.

```
distanceAsString = sprintf('%0.2f meters', distanceInMeters);
I1 = insertObjectAnnotation(I1, 'rectangle', face1, distanceAsString, 'FontSize', 18);
I2 = insertObjectAnnotation(I2, 'rectangle', face2, distanceAsString, 'FontSize', 18);
I1 = insertShape(I1, 'FilledRectangle', face1);
I2 = insertShape(I2, 'FilledRectangle', face2);

imshowpair(I1, I2, 'montage');
```



Input Arguments

matchedPoints1 — Coordinates of points in image 1

M-by-2 matrix | SURFPoints object | MSERRegions object | cornerPoints object | BRISKPoints object

Coordinates of points in image 1, specified as an *M*-by-2 matrix of *M* number of [x y] coordinates, or as a KAZEPoints, SURFPoints, MSERRegions, cornerPoints, or BRISKPoints object. The matchedPoints1 and matchedPoints2 inputs must contain points that are matched using a function such as matchFeatures.

matchedPoints2 — Coordinates of points in image 2

M-by-2 matrix | SURFPoints object | MSERRegions object | cornerPoints object | BRISKPoints object

Coordinates of points in image 2, specified as an *M*-by-2 matrix of *M* number of [x y] coordinates, or as a KAZEPoints, SURFPoints, MSERRegions, cornerPoints, or BRISKPoints object. The matchedPoints1 and matchedPoints2 inputs must contain points that are matched using a function such as matchFeatures.

stereoParams — Camera parameters for stereo system

stereoParameters object

Camera parameters for stereo system, specified as a `stereoParameters` object. The object contains the intrinsic, extrinsic, and lens distortion parameters of the stereo camera system. You can use the `estimateCameraParameters` function to estimate camera parameters and return a `stereoParameters` object.

When you pass a `stereoParameters` object to the function, the origin of the world coordinate system is located at the optical center of camera 1. The x-axis points to the right, the y-axis points down, and the z-axis points away from the camera.

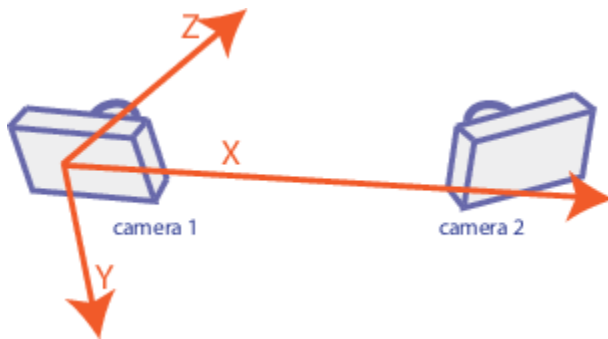
**cameraMatrix1 — Projection matrix for camera 1**

4-by-3 matrix

Projection matrix for camera 1, specified as a 4-by-3 matrix. The matrix maps a 3-D point in homogeneous coordinates onto the corresponding point in the image from the camera. This input describes the location and orientation of camera 1 in the world coordinate system. `cameraMatrix1` must be a real and nonsparse numeric matrix. You can obtain the camera matrix using the `cameraMatrix` function.

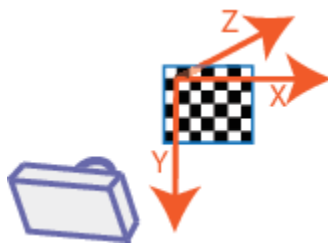

Camera matrices, passed to the function, define the world coordinate system.

cameraMatrix2 — Projection matrix for camera 2

4-by-3 projection matrix

Projection matrix for camera 2, specified as a 4-by-3 matrix. The matrix maps a 3-D point in homogeneous coordinates onto the corresponding point in the image from the camera. This input describes the location and orientation of camera 2 in the world coordinate system. `cameraMatrix2` must be a real and nonsparse numeric matrix. You can obtain the camera matrix using the `cameraMatrix` function.

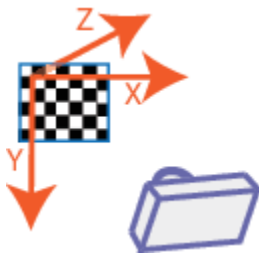

Camera matrices, passed to the function, define the world coordinate system.

Output Arguments

worldPoints — 3-D locations of matching pairs of undistorted image points

M-by-3 matrix

3-D locations of matching pairs of undistorted image points, returned as an *M*-by-3 matrix. The matrix contains *M* number of [x y z] locations of matching pairs of undistorted image points from two stereo images.

When you specify the camera geometry using `stereoParams`, the world point coordinates are relative to the optical center of camera 1.

When you specify the camera geometry using `cameraMatrix1` and `cameraMatrix2`, the world point coordinates are defined by the camera matrices.

The function returns `worldPoints` as data type `double` when `matchedPoints1` and `matchedPoints2` are of data type `double`. Otherwise, the function returns `worldPoints` as data type `single`.

Data Types: `single` | `double`

reprojectionErrors — Reprojection errors

M-by-1 vector

Reprojection errors, returned as an *M*-by-1 vector. The function projects each world point back into both images. Then, in each image, the function calculates the reprojection error as the distance between the detected and the reprojected point. The `reprojectionErrors` vector contains the average reprojection error for each world point.

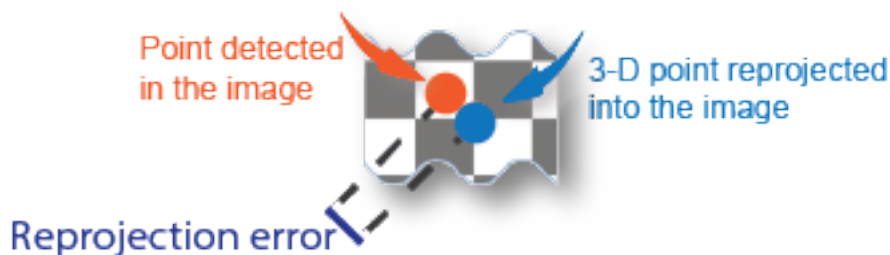

validIndex — Validity of world points

M-by-1 logical vector

Validity of world points, returned as an M -by-1 logical vector. Valid points, denoted as a logical 1 (`true`), are located in front of the cameras. Invalid points, denoted as a logical 0 (`false`), are located behind the cameras.

The validity of a world point with respect to the position of a camera is determined by projecting the world point onto the image using the camera matrix and homogeneous coordinates. The world point is valid if the resulting scale factor is positive.

Tips

The `triangulate` function does not account for lens distortion. You can undistort the images using the `undistortImage` function before detecting the points. Alternatively, you can undistort the points themselves using the `undistortPoints` function.

References

[1] Hartley, R. and A. Zisserman. "Multiple View Geometry in Computer Vision." *Cambridge University Press*, p. 312, 2003.

Extended Capabilities

C/C++ Code Generation

Generate C and C++ code using MATLAB® Coder™.

Usage notes and limitations:

- Use in a MATLAB Function block is not supported.

See Also

Apps

[Camera Calibrator](#) | [Stereo Camera Calibrator](#)

Functions

[triangulateMultiview](#) | [reconstructScene](#) | [estimateCameraParameters](#) | [cameraMatrix](#) | [undistortImage](#) | [undistortPoints](#) | [relativeCameraPose](#)

Objects

[stereoParameters](#) | [cameraParameters](#)

Topics

["Structure From Motion From Two Views"](#)

["Code Generation for Depth Estimation From Stereo Video"](#)

["Coordinate Systems"](#)

Introduced in R2014b

triangulateMultiview

3-D locations of world points matched across multiple images

Syntax

```
worldPoints = triangulateMultiview(pointTracks, cameraPoses, intrinsics)
[worldPoints, reprojectionErrors] = triangulateMultiview( ___ )
[worldPoints, reprojectionErrors, validIndex] = triangulateMultiview( ___ )
```

Description

`worldPoints = triangulateMultiview(pointTracks, cameraPoses, intrinsics)` returns the locations of 3-D world points that correspond to points matched across multiple images taken with calibrated cameras. `pointTracks` specifies an array of matched points. `cameraPoses` and `intrinsics` specify camera pose information and intrinsics, respectively. The function does not account for lens distortion.

`[worldPoints, reprojectionErrors] = triangulateMultiview(___)` additionally returns the mean reprojection error for each 3-D world point using all input arguments in the prior syntax.

`[worldPoints, reprojectionErrors, validIndex] = triangulateMultiview(___)` additionally returns the indices of valid and invalid world points. Valid points are located in front of the cameras.

Examples

Reconstruct Scene from Multiple Views

Load images in the workspace.

```
imageDir = fullfile(toolboxdir('vision'), 'visiondata', 'structureFromMotion');
images = imageSet(imageDir);
```

Load precomputed camera parameters.

```
data = load(fullfile(imageDir, 'cameraParams.mat'));
```

Get camera intrinsic parameters.

```
intrinsics = data.cameraParams.Intrinsics;
```

Compute features for the first image.

```
I = im2gray(read(images,1));
I = undistortImage(I, intrinsics);
pointsPrev = detectSURFFeatures(I);
[featuresPrev, pointsPrev] = extractFeatures(I, pointsPrev);
```

Load camera locations and orientations.

```
load(fullfile(imageDir, 'cameraPoses.mat'));
```

Create an imageviewset object.

```
vSet = imageviewset;  
vSet = addView(vSet,1,rigid3d(orientations(:,:,1),locations(1,:)),...  
    'Points',pointsPrev);
```

Compute features and matches for the rest of the images.

```
for i = 2:images.Count  
    I = im2gray(read(images,i));  
    I = undistortImage(I,intrinsics);  
    points = detectSURFFeatures(I);  
    [features,points] = extractFeatures(I,points);  
    vSet = addView(vSet,i,rigid3d(orientations(:,:,i), locations(i,:)),...  
        'Points',points);  
    pairsIdx = matchFeatures(featuresPrev,features,'MatchThreshold',5);  
    vSet = addConnection(vSet,i-1,i,'Matches',pairsIdx);  
    featuresPrev = features;  
end
```

Find point tracks.

```
tracks = findTracks(vSet);
```

Get camera poses.

```
cameraPoses = poses(vSet);
```

Find 3-D world points.

```
[xyzPoints,errors] = triangulateMultiview(tracks,cameraPoses,intrinsics);  
z = xyzPoints(:,3);  
idx = errors < 5 & z > 0 & z < 20;  
pcshow(xyzPoints(idx, :),'VerticalAxis','y','VerticalAxisDir','down','MarkerSize',30);  
hold on  
plotCamera(cameraPoses, 'Size', 0.2);  
hold off
```

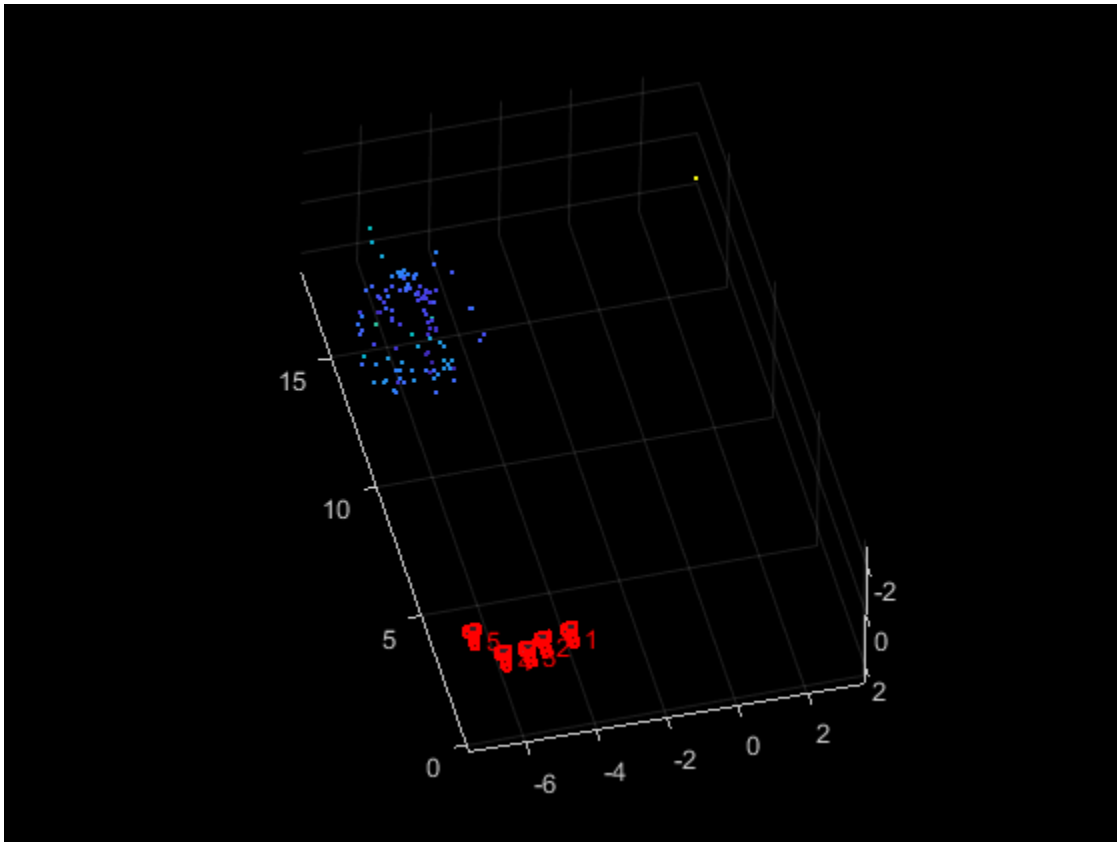

Input Arguments

pointTracks — Matched points across multiple images

N-element array of `pointTrack` objects

Matched points across multiple images, specified as an *N*-element array of `pointTrack` objects. Each element contains two or more points that match across multiple images.

cameraPoses — Camera pose information

two-column table | three-column table

Camera pose information, specified as a two-column or three-column table. You can obtain `cameraPoses` from an `imageviewset` object by using the `poses` object function.

Two-column Table

Column	Description
ViewID	View identifier in the <code>pointTrack</code> object, specified as an integer.
AbsolutePose	Absolute pose of the view, specified as a <code>rigid3d</code> object. You can obtain the <code>AbsolutePose</code> from the <code>imageviewset</code> object by using the <code>poses</code> object function.

Three-column Table

Column	Description
ViewID	View identifier in the pointTrack object, specified as an integer.
Orientation	Camera orientation, specified as a 3-by-3 rotation matrix.
Location	Camera location coordinates, specified as a three-element vector of the form $[x, y, z]$ and represented in the data units of the parent axes.

intrinsic — Camera intrinsic

cameraIntrinsic object | M -element vector of cameraIntrinsic objects

Camera intrinsic, specified as a cameraIntrinsic object or an M -element vector of cameraIntrinsic objects. M is the number of camera poses. When all images are captured by the same camera, specify one cameraIntrinsic object. When images are captured by different cameras, specify a vector.

Output Arguments**worldPoints** — 3-D world points

N -by-3 matrix

3-D world points, returned as an N -by-3 matrix. Each row represents one 3-D world point and is of the form $[x, y, z]$. N is the number of 3-D world points.

Data Types: single | double

reprojectionErrors — Reprojection errors

N -element vector

Reprojection errors, returned as an N -element vector. To calculate reprojection errors, first the function projects each world point back into each image. Then, in each image, the function calculates the distance between the detected and the reprojected point. Each element of the reprojectionErrors output is the average reprojection error for the corresponding world point in the worldPoints output.

**validIndex** — Validity of world points

M -by-1 logical vector

Validity of world points, returned as an M -by-1 logical vector. Valid points, denoted as a logical 1 (true), are located in front of the cameras. Invalid points, denoted as logical 0 (false), are located behind the cameras.

The validity of a world point with respect to the position of a camera is determined by projecting the world point onto the image using the camera matrix and homogeneous coordinates. The world point is valid if the resulting scale factor is positive.

Tips

Before detecting the points, correct the images for lens distortion by using by using the `undistortImage` function. Alternatively, you can directly undistort the points by using the `undistortPoints` function.

References

[1] Hartley, Richard, and Andrew Zisserman. *Multiple View Geometry in Computer Vision*. 2nd ed. Cambridge, UK; New York; Cambridge University Press, 2003.

See Also

Apps

Camera Calibrator

Functions

`undistortImage` | `estimateCameraParameters` | `bundleAdjustment` | `bundleAdjustmentMotion` | `bundleAdjustmentStructure` | `undistortPoints` | `relativeCameraPose`

Objects

`cameraParameters` | `pointTrack` | `imageviewset` | `rigid3d`

Topics

“Structure From Motion From Two Views”

“Code Generation for Depth Estimation From Stereo Video”

“Structure from Motion Overview”

“Coordinate Systems”

Introduced in R2016a

undistortImage

Correct image for lens distortion

Syntax

```
[J,newOrigin] = undistortImage(I, cameraParams)
[J,newOrigin] = undistortImage(I, cameraParams, interp)
[J,newOrigin] = undistortImage( ____, Name, Value)
```

Description

[J,newOrigin] = undistortImage(I, cameraParams) returns an image, J, containing the input image, I, with lens distortion removed. The function also returns the [x,y] location of the output image origin. The location is set in terms of the input intrinsic coordinates specified in cameraParams.

[J,newOrigin] = undistortImage(I, cameraParams, interp) specifies the interpolation method for the function to use on the input image.

[J,newOrigin] = undistortImage(____, Name, Value) specifies one or more Name, Value pair arguments, using any of the preceding syntaxes. Unspecified properties have their default values.

Examples

Correct Image for Lens Distortion

Create a set of calibration images.

```
images = imageDatastore(fullfile(toolboxdir('vision'),'visiondata', ...
    'calibration','mono'));
```

Detect calibration pattern.

```
[imagePoints, boardSize] = detectCheckerboardPoints(images.Files);
```

Generate world coordinates of the corners of the squares. The square size is in millimeters.

```
squareSize = 29;
worldPoints = generateCheckerboardPoints(boardSize, squareSize);
```

Calibrate the camera.

```
I = readimage(images,1);
imageSize = [size(I,1),size(I,2)];
cameraParams = estimateCameraParameters(imagePoints,worldPoints, ...
    'ImageSize',imageSize);
```

Remove lens distortion and display results.

```
I = images.readimage(1);
J1 = undistortImage(I, cameraParams);
```

```
figure; imshowpair(I,J1,'montage');  
title('Original Image (left) vs. Corrected Image (right)');
```

Original Image (left) vs. Corrected Image (right)



```
J2 = undistortImage(I,cameraParams,'OutputView','full');  
figure;  
imshow(J2);  
title('Full Output View');
```

Full Output View

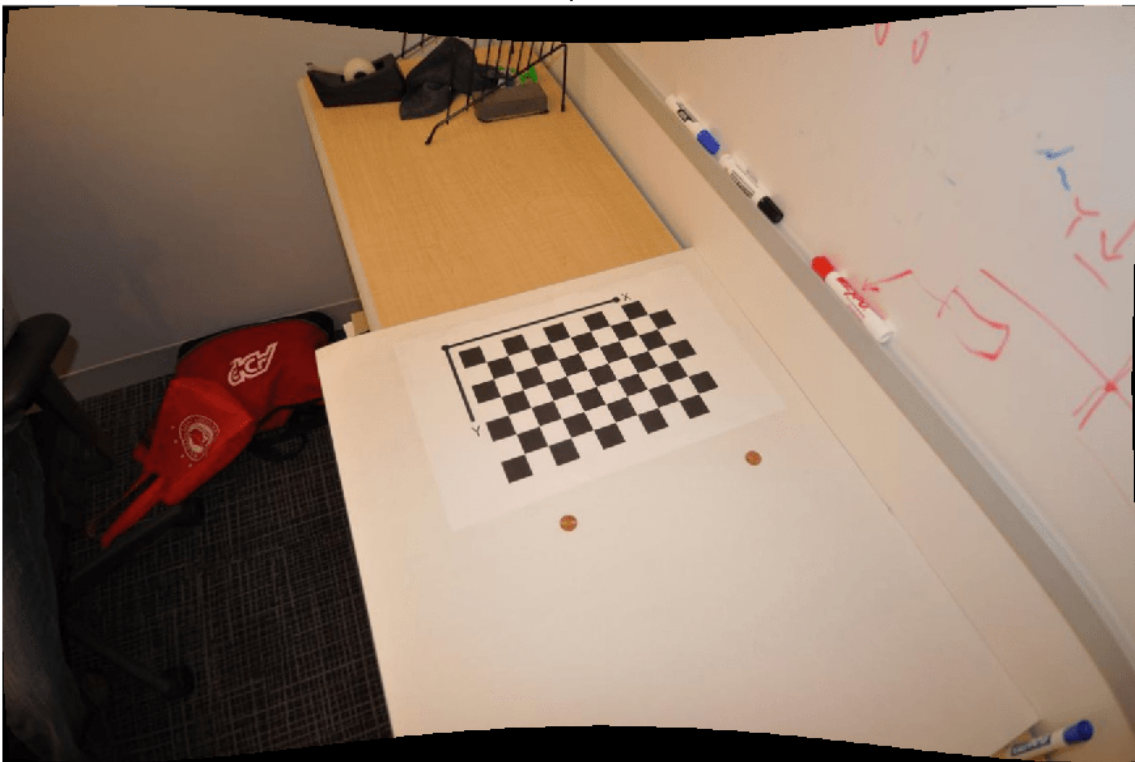

Input Arguments

I — Input image

M-by-*N*-by-3 truecolor image | *M*-by-*N* 2-D grayscale image

Input image, specified in either *M*-by-*N*-by-3 truecolor or *M*-by-*N* 2-D grayscale. The input image must be real and nonsparse.

Data Types: `single` | `double` | `int16` | `uint8` | `uint16` | `logical`

cameraParams — Object for storing camera parameters

`cameraParameters` object | `cameraIntrinsics` object

Camera parameters, specified as a `cameraParameters` or `cameraIntrinsics` object. You can return the `cameraParameters` object using the `estimateCameraParameters` function. The `cameraParameters` object contains the intrinsic, extrinsic, and lens distortion parameters of a camera.

interp — Interpolation method

'linear' (default) | 'nearest' | 'cubic'

Interpolation method to use on the input image, specified as 'linear', 'nearest', or 'cubic'.

Name-Value Pair Arguments

Specify optional comma-separated pairs of `Name`, `Value` arguments. `Name` is the argument name and `Value` is the corresponding value. `Name` must appear inside quotes. You can specify several name and value pair arguments in any order as `Name1`, `Value1`, ..., `NameN`, `ValueN`.

Example: 'FillValues',0 sets the sets the output pixel fill values to 0.

FillValues — Output pixel fill values

0 (default) | scalar | 3-element vector

Output pixel fill values, specified as the comma-separated pair consisting of 'FillValues' and an array containing one or more fill values. When the corresponding inverse transformed location in the input image lies completely outside the input image boundaries, you use the fill values for output pixels. When you use a 2-D grayscale input image, you must set the `FillValues` to scalar. When you use a truecolor, `FillValues` can be a scalar or a 3-element vector of RGB values.

OutputView — Size of output image



'same' (default) | 'full' | 'valid'

Size of output image, specified as the comma-separated pair consisting of 'OutputView' and 'same', 'full', or 'valid'. When you set the property to 'same', the function sets the output image to match the size of the input image. When you set the property to 'full', the output includes all pixels from the input image. When you set the property to 'valid', the function crops the output image to contain only valid pixels.

For the input image:

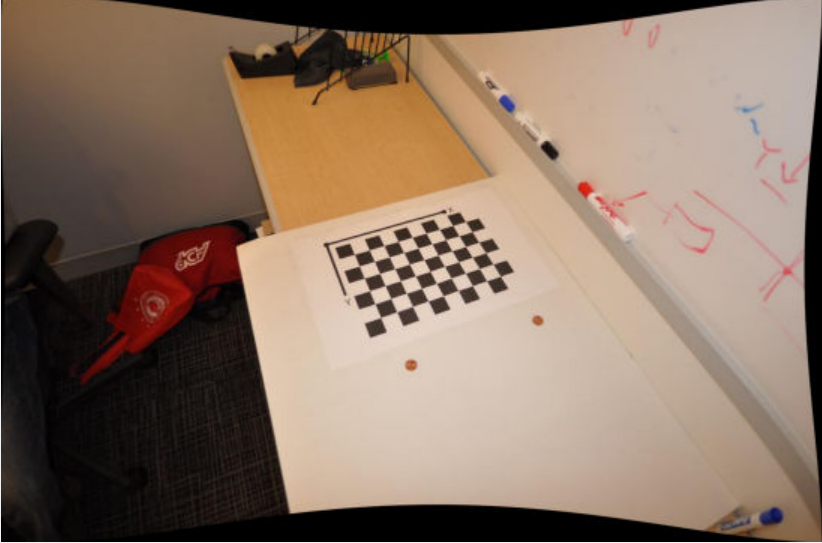

OutputView	Output Image
' same '	<p data-bbox="456 894 876 926">Match the size of the input image.</p> 

OutputView	Output Image
'full'	<p>All pixels from the input image.</p> 
'valid'	<p>Only valid pixels from the input image.</p> 

Output Arguments

J — Undistorted image

M-by-*N*-by-3 truecolor image | *M*-by-*N* 2-D grayscale image

Undistorted image, returned in either *M*-by-*N*-by-3 truecolor or *M*-by-*N* 2-D grayscale.

Data Types: `single` | `double` | `int16` | `uint8` | `uint16` | `logical`

newOrigin — Output image origin

2-element vector

Output image origin, returned as a 2-element [x,y] vector. The function sets the output origin location in terms of the input intrinsic coordinates. When you set `OutputView` to 'same', which means the output image is the same size as the input image, the function sets the `newOrigin` to [0,0].

The `newOrigin` output represents the translation from the intrinsic coordinates of the output image `J` into the intrinsic coordinates of the input image `I`.

Let P_I represent a point in the intrinsic coordinates of input image `I`.

Let P_J represent the same point in the intrinsic coordinates of the output image `J`.

$$P_I = P_J + \text{newOrigin}$$

Extended Capabilities

C/C++ Code Generation

Generate C and C++ code using MATLAB® Coder™.

Usage notes and limitations:

- Use in a MATLAB Function block is not supported.
- 'interp' and 'OutputView' must be compile-time constants.

See Also

[Camera Calibrator](#) | [Stereo Camera Calibrator](#) | [estimateCameraParameters](#) | [triangulate](#) | [undistortPoints](#) | [extrinsics](#) | [cameraParameters](#) | [cameraIntrinsics](#) | [stereoParameters](#)

Topics

“Code Generation for Depth Estimation From Stereo Video”

Introduced in R2014a

undistortPoints

Correct point coordinates for lens distortion

Syntax

```
undistortedPoints = undistortPoints(points, cameraParams)  
[undistortedPoints, reprojectionErrors] = undistortPoints(points, cameraParams)
```

Description

`undistortedPoints = undistortPoints(points, cameraParams)` returns point coordinates corrected for lens distortion. This function uses numeric nonlinear least-squares optimization.

`[undistortedPoints, reprojectionErrors] = undistortPoints(points, cameraParams)` additionally returns the errors used to evaluate the accuracy of undistorted points.

Examples

Undistort Checkerboard Points

Create an `imageDatastore` object containing calibration images.

```
images = imageDatastore(fullfile(toolboxdir('vision'),'visiondata', ...  
    'calibration','mono'));  
imageFileNames = images.Files;
```

Detect the calibration pattern.

```
[imagePoints, boardSize] = detectCheckerboardPoints(imageFileNames);
```

Generate world coordinates of the corners of the squares. The square size is in millimeters.

```
squareSize = 29;  
worldPoints = generateCheckerboardPoints(boardSize, squareSize);
```

Calibrate the camera.

```
I = readimage(images, 10);  
imageSize = [size(I, 1), size(I, 2)];  
params = estimateCameraParameters(imagePoints, worldPoints, ...  
    'ImageSize', imageSize);
```

Load an image and detect the checkerboard points.

```
points = detectCheckerboardPoints(I);
```

Undistort the points

```
undistortedPoints = undistortPoints(points, params);
```

Undistort the image.

```
[J, newOrigin] = undistortImage(I,params, 'OutputView','full');
```

Translate undistorted points

```
undistortedPoints = [undistortedPoints(:,1) - newOrigin(1), ...
                    undistortedPoints(:,2) - newOrigin(2)];
```

Display the results

```
figure;
imshow(I);
hold on;
plot(points(:,1),points(:,2),'r*-');
title('Detected Points');
hold off;
```

Detected Points

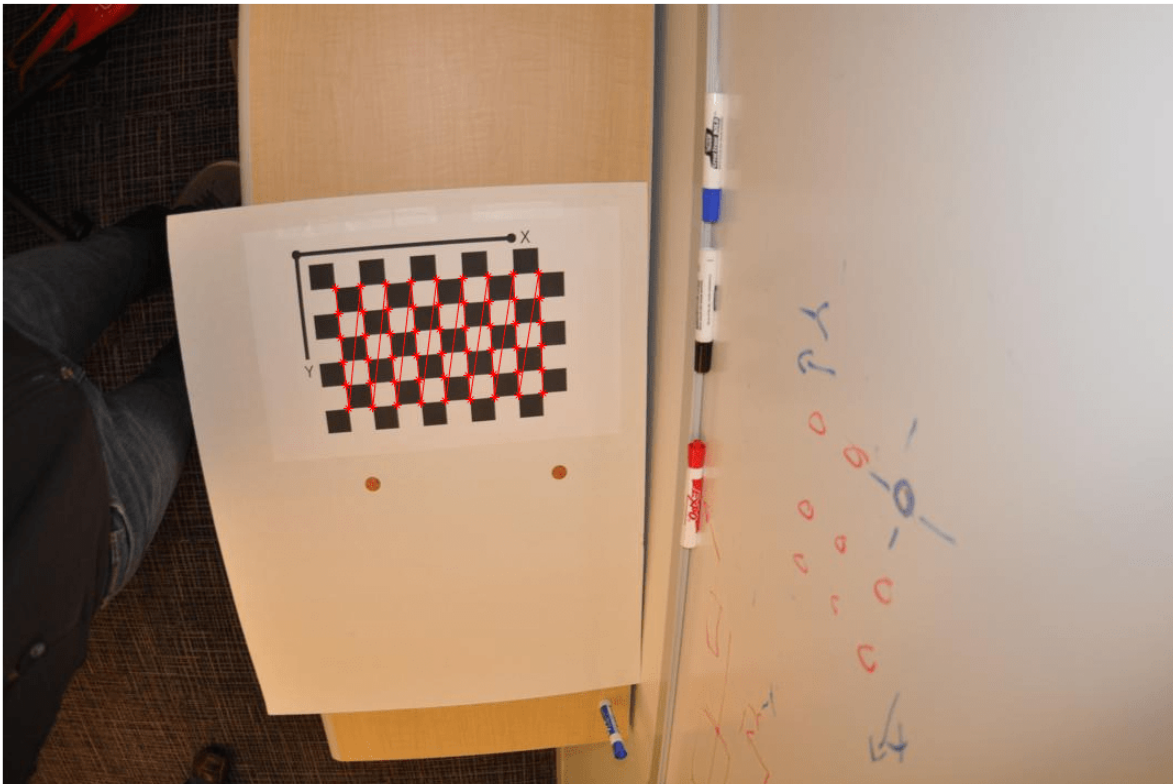

```
figure;
imshow(J);
hold on;
plot(undistortedPoints(:,1),undistortedPoints(:,2),'g*-');
title('Undistorted Points');
hold off;
```

Undistorted Points

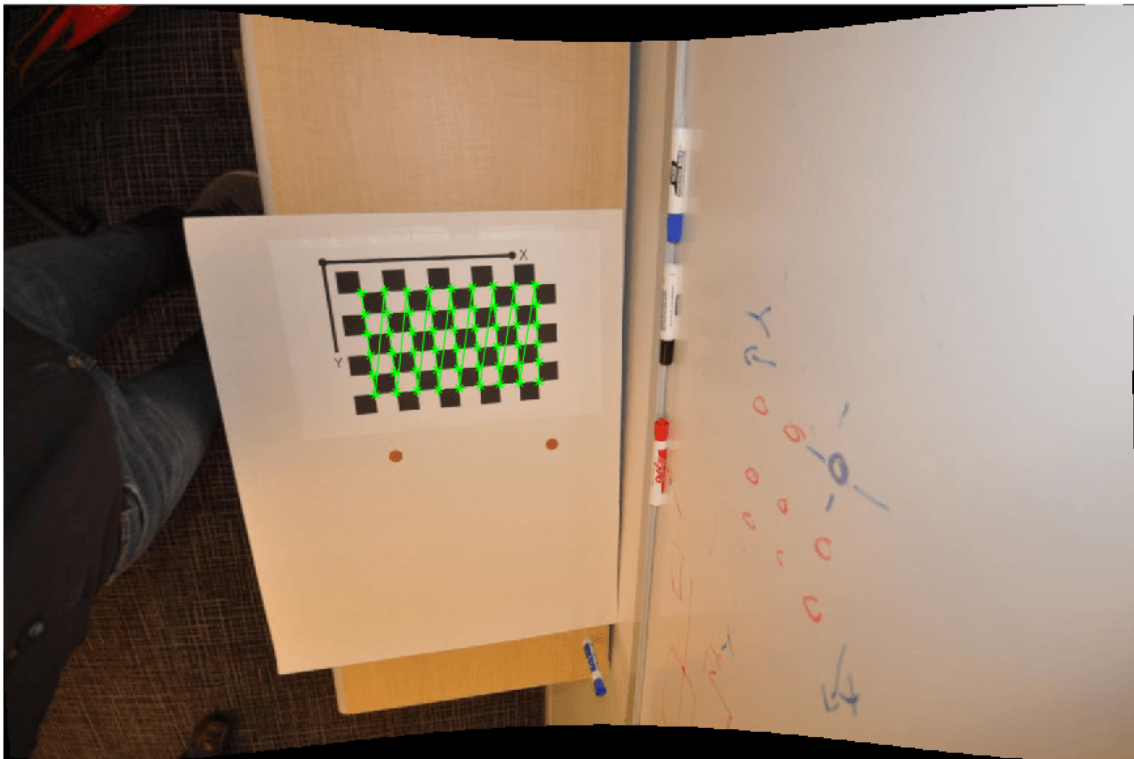

Input Arguments

points — Input points

M-by-2 matrix

Input points, specified as an *M*-by-2 matrix of *M* number of [x y] coordinates.

cameraParams — Object for storing camera parameters

cameraParameters object | cameraIntrinsics object

Camera parameters, specified as a cameraParameters or cameraIntrinsics object. You can return the cameraParameters object using the estimateCameraParameters function. The cameraParameters object contains the intrinsic, extrinsic, and lens distortion parameters of a camera.

Output Arguments

undistortedPoints — Undistorted points

M-by-2 matrix

Undistorted points, returned as an *M*-by-2 matrix. The undistortedPoints output contains *M* [x,y] point coordinates corrected for lens distortion. When you input points as double, the function outputs undistortedPoints as double. Otherwise, it outputs undistortedPoints as single.

Data Types: `single` | `double`

reprojectionErrors — Reprojection errors

M-by-1 vector

Reprojection errors, returned as an *M*-by-1 vector. You can use the errors to evaluate the accuracy of undistorted points. The function computes the errors by applying distortion to the undistorted points, and then taking the distances between the result and the corresponding input points. The `reprojectionErrors` output is in pixels.

See Also

Camera Calibrator | **Stereo Camera Calibrator** | `estimateCameraParameters` | `triangulate` | `extrinsics` | `cameraParameters` | `cameraIntrinsics` | `stereoParameters`

Introduced in R2014b

visionlib

Open top-level Computer Vision Toolbox Simulink library

Syntax

```
visionlib
```

Description

`visionlib` opens the top-level Computer Vision Toolbox block library.

Examples

Open Computer Vision Toolbox Block Library

View and gain access to the Computer Vision Toolbox blocks.

```
visionlib
```

Alternatives

To view and gain access to the Computer Vision Toolbox blocks using the Simulink library browser:

- Type `simulink` at the MATLAB command line, and then expand the Computer Vision Toolbox node in the library browser.
- Click the Simulink icon  from the MATLAB desktop or from a model.

See Also

Introduced in R2011a

visionSupportPackages

Start installer to download, install, or uninstall Computer Vision Toolbox data

Syntax

visionSupportPackages

Description

visionSupportPackages launches the Support Package Installer, which you can use to download, install, or uninstall support packages for Computer Vision Toolbox.

Computer Vision Toolbox Support Packages

“Install OCR Language Data Files”

“Install and Use Computer Vision Toolbox Interface for OpenCV in MATLAB”

Examples

Start Computer Vision Toolbox installer

visionSupportPackages

See Also

Topics

“Install Computer Vision Toolbox Add-on Support Files”

Introduced in R2014b

ocvStructToKeyPoints

Convert MATLAB feature points struct to OpenCV KeyPoint vector

C++ Syntax

```
#include "opencvmex.hpp"  
void ocvStructToKeyPoints(const mxArray * in,cv::vector<cv::KeyPoint>  
&keypoints);
```

Arguments

in

Pointer to a MATLAB structure, mxArray, that represents a point feature. Format:

Field Name	Field Requirement	Field Data Type
Location	Required	Single
Scale	Required	Single
Metric	Required	Single
Orientation	Optional	Single
Octave	Optional	int32
Misc	Optional	int32

Description

The `ocvStructToKeyPoints` function converts a point feature data structure from a MATLAB struct to an OpenCV's `KeyPoint` vector.

See Also

`mxArray`, `ocvKeyPointsToStruct`, "C Matrix API", "C MEX File Applications"

Introduced in R2015a

ocvMxGpuArrayToGpuMat_{DataType}

Create `cv::gpu::GpuMat` from `mxArray` containing GPU data.

C++ Syntax

Note This function will be removed in a future release.

```
#include "opencvgpumex.hpp"
cv::Ptr<cv::gpu::GpuMat> ocvMxGpuArrayToGpuMat_double(const mxArray * in);
cv::Ptr<cv::gpu::GpuMat> ocvMxGpuArrayToGpuMat_single(const mxArray * in);
cv::Ptr<cv::gpu::GpuMat> ocvMxGpuArrayToGpuMat_uint8(const mxArray * in);
cv::Ptr<cv::gpu::GpuMat> ocvMxGpuArrayToGpuMat_uint16(const mxArray * in);
cv::Ptr<cv::gpu::GpuMat> ocvMxGpuArrayToGpuMat_uint32(const mxArray * in);
cv::Ptr<cv::gpu::GpuMat> ocvMxGpuArrayToGpuMat_int8(const mxArray * in);
cv::Ptr<cv::gpu::GpuMat> ocvMxGpuArrayToGpuMat_int16(const mxArray * in);
cv::Ptr<cv::gpu::GpuMat> ocvMxGpuArrayToGpuMat_int32(const mxArray * in);
cv::Ptr<cv::gpu::GpuMat> ocvMxGpuArrayToGpuMat_bool(const mxArray * in);
```

Arguments

`in`

Pointer to a MATLAB struct, `mxArray`, containing GPU data. Supported data types:

<code>real_T</code> (double)	<code>real32_T</code> (single)	<code>uint8_T</code> (uint8)
<code>uint16_T</code> (uint16)	<code>uint32_T</code> (uint32)	<code>int8_T</code> (int8)
<code>int16_T</code> (int16)	<code>int32_T</code> (int32)	<code>boolean_T</code> (bool)

Returns

OpenCV smart pointer (`cv::Ptr`) to a `cv::gpu::GpuMat` object.

Description

The `ocvMxGpuArrayToGpuMat_{DataType}` function creates a `cv::gpu::GpuMat` object from an `mxArray` containing GPU data. This function requires the Parallel Computing Toolbox software.

See Also

`mxArray`, `ocvMxGpuArrayFromGpuMat_{DataType}`, “C Matrix API”, “C MEX File Applications”

Introduced in R2015a

ocvMxGpuArrayFromGpuMat_{DataType}

Create an mxArray from cv::gpu::GpuMat object

C++ Syntax

Note This function will be removed in a future release.

```
#include "opencvgpumex.hpp"
mxArray * ocvMxGpuArrayFromGpuMat_double(const cv::gpu::GpuMat & in);
mxArray * ocvMxGpuArrayFromGpuMat_single(const cv::gpu::GpuMat & in);
mxArray * ocvMxGpuArrayFromGpuMat_uint8(const cv::gpu::GpuMat & in);
mxArray * ocvMxGpuArrayFromGpuMat_uint16(const cv::gpu::GpuMat & in);
mxArray * ocvMxGpuArrayFromGpuMat_uint32(const cv::gpu::GpuMat & in);
mxArray * ocvMxGpuArrayFromGpuMat_int8(const cv::gpu::GpuMat & in);
mxArray * ocvMxGpuArrayFromGpuMat_int16(const cv::gpu::GpuMat & in);
mxArray * ocvMxGpuArrayFromGpuMat_int32(const cv::gpu::GpuMat & in);
mxArray * ocvMxGpuArrayFromGpuMat_bool(const cv::gpu::GpuMat & in)
```

Arguments

in

Reference to OpenCV cv::gpu::GpuMat object.

Returns

Pointer to a MATLAB struct, mxArray, containing GPU data. Supported data types:

real_T (double)	real32_T (single)	uint8_T (uint8)
uint16_T (uint16)	uint32_T (uint32)	int8_T (int8)
int16_T (int16)	int32_T (int32)	boolean_T (bool)

Description

The ocvMxGpuArrayFromGpuMat function creates an mxArray from a cv::gpu::GpuMat object. GpuMat supports 2-D arrays only. This function requires the Parallel Computing Toolbox software.

See Also

mxArray, ocvMxGpuArrayToGpuMat_{DataType}, “C Matrix API”, “C MEX File Applications”

Introduced in R2015a

ocvMxArrayToSize_{DataType}

Convert 2-element mxArray to cv::Size.

C++ Syntax

```
#include "opencvmex.hpp"
cv::Size ocvMxArrayToSize_single(const mxArray * in, bool rcInput = true);
cv::Size ocvMxArrayToSize_int32(const mxArray * in, bool rcInput = true);
```

Arguments

in

Pointer to a MATLAB mxArray having 2 elements. Supported data types:

single
int32

rcInput

Boolean flag that indicates if input mxArray is of the format [r c] or [x y].

rcInput	in
true (default)	[r c] (<i>height, width</i>)
false	[x y] (<i>width, height</i>)

Returns

OpenCV cv::Size

Description

The ocvMxArrayToSize_{DataType} function converts a 2-element mxArray to cv::Size. Empty input ([]) returns cv::Size(0,0);

See Also

mxArray, “C Matrix API”, “C MEX File Applications”

Introduced in R2015a

ocvMxArrayToMat_{DataType}

Convert column major mxArray to row major cv::Mat for generic matrix

C++ Syntax

```
#include "opencvmex.hpp"
void ocvMxArrayToMat_double(const mxArray *in, cv::Mat &out);
void ocvMxArrayToMat_single(const mxArray *in, cv::Mat &out);
void ocvMxArrayToMat_uint8(const mxArray *in, cv::Mat &out);
void ocvMxArrayToMat_uint16(const mxArray *in, cv::Mat &out);
void ocvMxArrayToMat_uint32(const mxArray *in, cv::Mat &out);
void ocvMxArrayToMat_int8(const mxArray *in, cv::Mat &out);
void ocvMxArrayToMat_int16(const mxArray *in, cv::Mat &out);
void ocvMxArrayToMat_int32(const mxArray *in, cv::Mat &out);
void ocvMxArrayToMat_bool(const mxArray *in, cv::Mat &out);
cv::Ptr<cv::Mat> ocvMxArrayToMat_double(const mxArray *in, const bool
copyData = true);
cv::Ptr<cv::Mat> ocvMxArrayToMat_single(const mxArray *in, const bool
copyData = true);
cv::Ptr<cv::Mat> ocvMxArrayToMat_uint8(const mxArray *in, const bool copyData
= true);
cv::Ptr<cv::Mat> ocvMxArrayToMat_uint16(const mxArray *in, const bool
copyData = true);
cv::Ptr<cv::Mat> ocvMxArrayToMat_uint32(const mxArray *in, const bool
copyData = true);
cv::Ptr<cv::Mat> ocvMxArrayToMat_int8(const mxArray *in, const bool copyData
= true);
cv::Ptr<cv::Mat> ocvMxArrayToMat_int16(const mxArray *in, const bool copyData
= true);
cv::Ptr<cv::Mat> ocvMxArrayToMat_int32(const mxArray *in, const bool copyData
= true);
cv::Ptr<cv::Mat> ocvMxArrayToMat_uint8(const mxArray *in, const bool copyData
= true);
```

Arguments

in

Pointer to a MATLAB struct, mxArray, having column major data. The data can be *n*-channel matrices. Supported data types:

real_T (double)	uint8_T (uint8)	uint32_T (uint32)	int16_T (int16)
real32_T (single)	uint16_T (uint16)	int8_T (int8)	int32_T (int32)

copyData

Boolean flag to copy data from mxArray to the Mat object.

- `true` (default) — The function transposes and interleaves (for RGB images) column major mxArray data into a row major cv::Mat object.

- `false` — No data copies from the `mxArray` to the `Mat` object. The function creates a new `Mat` wrapper and uses it to point to the `mxArray` data. Because OpenCV is row-based and MATLAB is column-based, the columns of the `mxArray` become the rows of the `Mat` object. If the image is 2-D, then `copyData` is `false`.

`out`

Reference to OpenCV `cv::Mat` with row major data.

Returns

The functions that set `copyData` return an OpenCV smart pointer (`cv::Ptr`) to a `cv::Mat` object.

Description

The `ocvMxArrayToMat_{DataType}` function applies to two C++ implementations. One set returns `void` and the other set returns an OpenCV smart pointer. The functions that return `void` reallocate memory for the `cv::Mat` if needed.

The `ocvMxArrayToMat_{DataType}` transposes and interleaves column major `mxArray` data into row major `cv::Mat`. This matrix conversion is a generic routine for any number of channels.

See Also

`mxArray`, `ocvMxArrayToImage_{DataType}`, `ocvMxArrayFromMat_{DataType}`, “C Matrix API”, “C MEX File Applications”

Introduced in R2015a

ocvMxArrayToImage_{DataType}

Convert column major mxArray to row major cv::Mat for image

C++ Syntax

```
#include "opencvmex.hpp"
void ocvMxArrayToImage_double(const mxArray *in, cv::Mat &out);
void ocvMxArrayToImage_single(const mxArray *in, cv::Mat &out);
void ocvMxArrayToImage_uint8(const mxArray *in, cv::Mat &out);
void ocvMxArrayToImage_uint16(const mxArray *in, cv::Mat &out);
void ocvMxArrayToImage_uint32(const mxArray *in, cv::Mat &out);
void ocvMxArrayToImage_int8(const mxArray *in, cv::Mat &out);
void ocvMxArrayToImage_int16(const mxArray *in, cv::Mat &out);
void ocvMxArrayToImage_int32(const mxArray *in, cv::Mat &out);
void ocvMxArrayToImage_bool(const mxArray *in, cv::Mat &out);
cv::Ptr<cv::Mat> ocvMxArrayToImage_double(const mxArray *in, const bool
copyData = true);
cv::Ptr<cv::Mat> ocvMxArrayToImage_single(const mxArray *in, const bool
copyData = true);
cv::Ptr<cv::Mat> ocvMxArrayToImage_uint8(const mxArray *in, const bool
copyData = true);
cv::Ptr<cv::Mat> ocvMxArrayToImage_uint16(const mxArray *in, const bool
copyData = true);
cv::Ptr<cv::Mat> ocvMxArrayToImage_uint32(const mxArray *in, const bool
copyData = true);
cv::Ptr<cv::Mat> ocvMxArrayToImage_int8(const mxArray *in, const bool
copyData = true);
cv::Ptr<cv::Mat> ocvMxArrayToImage_int16(const mxArray *in, const bool
copyData = true);
cv::Ptr<cv::Mat> ocvMxArrayToImage_int32(const mxArray *in, const bool
copyData = true);
cv::Ptr<cv::Mat> ocvMxArrayToImage_bool(const mxArray *in, const bool
copyData = true);
```

Arguments

in

Pointer to a MATLAB struct, mxArray, having column major data that represents a 2-D or 3-D image. Supported data types:

real_T (double)	uint8_T (uint8)	uint32_T (uint32)	int16_T (int16)
real32_T (single)	uint16_T (uint16)	int8_T (int8)	int32_T (int32)

copyData

Boolean flag to copy data from mxArray to the Mat object.

- `true` (default) — The function transposes and interleaves (for RGB images) column major mxArray data into a row major cv::Mat object.

- `false` — No data copies from the `mxArray` to the `Mat` object. The function creates a new `Mat` wrapper and uses it to point to the `mxArray` data. Because OpenCV is row-based and MATLAB is column-based, the columns of the `mxArray` become the rows of the `Mat` object. If the image is 2-D, then `copyData` is `false`.

out

Reference to OpenCV `cv::Mat` with row major data.

Returns

The functions that set `copyData` return an OpenCV smart pointer (`cv::Ptr`) to a `cv::Mat` object.

Description

The `ocvMxArrayToImage_{DataType}` function applies to two C++ implementations. One set returns `void` and the other set returns an OpenCV smart pointer. The functions that return `void` reallocate memory for the `cv::Mat` if needed.

The `ocvMxArrayToImage_{DataType}` transposes and interleaves column major `mxArray` data into row major `cv::Mat`. The `ocvMxArrayToImage_{DataType}` function supports 2-D and 3-D images.

These functions are not a generic matrix conversion routine. For 3-D images, they take into account that the OpenCV format uses BGR ordering and manipulate the data to comply with that formatting.

See Also

`mxArray`, `ocvMxArrayToMat_{DataType}`, `ocvMxArrayFromImage_{DataType}`, "C Matrix API", "C MEX File Applications"

Introduced in R2015a

ocvMxArrayToCvRect

Convert a MATLAB struct representing a rectangle to an OpenCV CvRect

C++ Syntax

```
#include "opencvmex.hpp"  
CvRect ocvMxArrayToCvRect(const mxArray *in);
```

Arguments

in

Pointer to a MATLAB structure, `mxArray`, that represents a rectangle. The structure must have four scalar-valued fields: `x`, `y`, `width`, and `height`. The (`x`, `y`) fields represent the upper-left corner of the rectangle.

Returns

OpenCV CvRect.

Description

The `ocvMxArrayToCvRect` function converts a rectangle data structure from a MATLAB struct to an OpenCV KeyPoint vector.

See Also

`mxArray`, `ocvCvRectToMxArray`, “C Matrix API”, “C MEX File Applications”

Introduced in R2015a

ocvMxArrayFromVector_{DataType}

Convert numeric vectorT to mxArray

C++ Syntax

```
#include "opencvmex.hpp"
mxArray *ocvMxArrayFromVector_double(const std::vector<real_T> &v);
mxArray *ocvMxArrayFromVector_single(const std::vector<real32_T> &v);
mxArray *ocvMxArrayFromVector_uint8(const std::vector<uint8_T> &v);
mxArray *ocvMxArrayFromVector_uint16(const std::vector<uint16_T> &v);
mxArray *ocvMxArrayFromVector_uint32(const std::vector<uint32_T> &v);
mxArray *ocvMxArrayFromVector_int8(const std::vector<int8_T> &v);
mxArray *ocvMxArrayFromVector_int16(const std::vector<int16_T> &v);
mxArray *ocvMxArrayFromVector_int32(const std::vector<int32_T> &v);
mxArray *ocvMxArrayFromVector_bool(const std::vector<boolean_T> &v);
```

Arguments

v

Reference to vector<DataType>. Supported data types:

real_T	real32_T	uint8_T
uint16_T	uint32_T	int8_T
int16_T	int32_T	boolean_T

Returns

Pointer to a MATLAB struct mxArray.

Description

The ocvMxArrayFromVector_{DataType} function converts numeric std::vector<DataType> to an mxArray.

See Also

mxArray, “C Matrix API”, “C MEX File Applications”

Introduced in R2015a

ocvMxArrayFromPoints2f

Converts `vector<cv::Point2f>` to `mxArray`

C++ Syntax

```
#include "opencvmex.hpp"  
mxArray *ocvMxArrayFromPoints2f(const std::vector<cv::Point2f> &points);
```

Arguments

`points`

Reference to OpenCV `vector<cv::Point2f>`.

Returns

Pointer to a MATLAB `mxArray`.

Description

The `ocvMxArrayFromPoints2f` function converts `std::vector<cv::Point2f>` to an `mxArray`.

See Also

“C Matrix API”, “C MEX File Applications”

Introduced in R2015a

ocvMxArrayFromMat_{DataType}

Convert row major cv::Mat to column major mxArray for generic matrix

C++ Syntax

```
#include "opencvmex.hpp"
mxArray *ocvMxArrayFromMat_double(const cv::Mat &in);
mxArray *ocvMxArrayFromMat_single(const cv::Mat &in);
mxArray *ocvMxArrayFromMat_uint8(const cv::Mat &in);
mxArray *ocvMxArrayFromMat_uint16(const cv::Mat &in);
mxArray *ocvMxArrayFromMat_uint32(const cv::Mat &in);
mxArray *ocvMxArrayFromMat_int8(const cv::Mat &in);
mxArray *ocvMxArrayFromMat_int16(const cv::Mat &in);
mxArray *ocvMxArrayFromMat_int32(const cv::Mat &in);
mxArray *ocvMxArrayFromMat_bool(const cv::Mat &in);
```

Arguments

in

Reference to OpenCV cv::Mat with row major data.

Returns

Pointer to a MATLAB struct, mxArray, having column major data. Supported data types:

real_T (double)	uint8_T (uint8)	uint32_T (uint32)	int16_T (int16)
real32_T (single)	uint16_T (uint16)	int8_T (int8)	int32_T (int32)

Description

The `ocvMxArrayFromMat_{DataType}` function creates an mxArray from a cv::Mat object. The mxArray contains column major data and cv::Mat contains row major data. This matrix conversion is a generic routine for any number of channels.

See Also

mxArray, `ocvMxArrayToImage_{DataType}`, `ocvMxArrayFromImage_{DataType}`, `ocvMxArrayToMat_{DataType}`, “C Matrix API”, “C MEX File Applications”

Introduced in R2015a

ocvMxArrayFromImage_{DataType}

Convert row major cv::Mat to column major mxArray for image

C++ Syntax

```
#include "opencvmex.hpp"
mxArray *ocvMxArrayFromImage_double(const cv::Mat &in);
mxArray *ocvMxArrayFromImage_single(const cv::Mat &in);
mxArray *ocvMxArrayFromImage_uint8(const cv::Mat &in);
mxArray *ocvMxArrayFromImage_uint16(const cv::Mat &in);
mxArray *ocvMxArrayFromImage_uint32(const cv::Mat &in);
mxArray *ocvMxArrayFromImage_int8(const cv::Mat &in);
mxArray *ocvMxArrayFromImage_int16(const cv::Mat &in);
mxArray *ocvMxArrayFromImage_int32(const cv::Mat &in);
mxArray *ocvMxArrayFromImage_bool(const cv::Mat &in);
```

Arguments

in

Reference to OpenCV cv::Mat with row major data.

Returns

Pointer to a MATLAB struct, mxArray, with column major data. Supported data types:

real_T (double)	uint8_T (uint8)	uint32_T (uint32)	int16_T (int16)
real32_T (single)	uint16_T (uint16)	int8_T (int8)	int32_T (int32)

Description

The `ocvMxArrayFromImage_{DataType}` function creates an mxArray from a cv::Mat object. The mxArray contains column major data and the cv::Mat contains row major data.

This function is not a generic matrix conversion routine. For 3-D images, it takes into account that the OpenCV format uses BGR ordering and manipulates the data to comply with that formatting.

See Also

mxArray, `ocvMxArrayToImage_{DataType}`, `ocvMxArrayFromMat_{DataType}`, “C Matrix API”, “C MEX File Applications”

Introduced in R2015a

ocvKeyPointsToStruct

Convert OpenCV KeyPoint vector to MATLAB struct

C++ Syntax

```
#include "opencvmex.hpp"
mxArray *ocvKeyPointsToStruct(cv::vector<cv::KeyPoint> &in);
```

Arguments

in

Reference to an OpenCV's KeyPoint vector.

Returns

Pointer to a MATLAB structure mxArray that represents a point feature.

Format:

Field Name	Field Requirement	Field Data Type
Location	Required	Single
Scale	Required	Single
Metric	Required	Single
Orientation	Optional	Single
Octave	Optional	int32
Misc	Optional	int32

Description

The `ocvKeyPointsToStruct` function converts a point feature data structure from an OpenCV KeyPoint vector to a MATLAB struct.

See Also

`mxArray`, `ocvStructToKeyPoints`, “C Matrix API”, “C MEX File Applications”

Introduced in R2015a

ocvCvRectToMxArray

Convert OpenCV CvRect to a MATLAB struct

C++ Syntax

```
#include "opencvmex.hpp"  
mxArray *ocvCvRectToMxArray(const CvRect *in);
```

Arguments

in

Pointer to OpenCV CvRect.

Returns

Pointer to a MATLAB structure, *mxArray*, that represents a rectangle. The structure must have four scalar-valued fields, *x*, *y*, *width*, and *height*. The (*x*, *y*) fields represent the upper-left corner of the rectangle.

Description

The *ocvCvRectToMxArray* function converts a rectangle data structure from an OpenCV KeyPoint vector to a MATLAB struct.

See Also

mxArray, *ocvMxArrayToCvRect*, “C Matrix API”, “C MEX File Applications”

Introduced in R2015a

ocvCvRectToBoundingBox_{DataType}

Convert `vector<cv::Rect>` to *M*-by-4 mxArray of bounding boxes

C++ Syntax

```
#include "opencvmex.hpp"
mxArray * ocvCvRectToBoundingBox_double(const std::vector<cv::Rect> & rects);
mxArray * ocvCvRectToBoundingBox_single(const std::vector<cv::Rect> & rects);
mxArray * ocvCvRectToBoundingBox_uint8(const std::vector<cv::Rect> & rects);
mxArray * ocvCvRectToBoundingBox_uint16(const std::vector<cv::Rect> & rects);
mxArray * ocvCvRectToBoundingBox_uint32(const std::vector<cv::Rect> & rects);
mxArray * ocvCvRectToBoundingBox_int8(const std::vector<cv::Rect> & rects);
mxArray * ocvCvRectToBoundingBox_int16(const std::vector<cv::Rect> & rects);
mxArray * ocvCvRectToBoundingBox_int32(const std::vector<cv::Rect> & rects);
```

Arguments

`rects`

Reference to OpenCV `vector<cv::Rect>`.

Returns

Pointer to a MATLAB mxArray having *M*-by-4 elements. Supported data types:

<code>real_T</code> (double)	<code>uint8_T</code> (uint8)	<code>uint32_T</code> (uint32)	<code>int16_T</code> (int16)
<code>real32_T</code> (single)	<code>uint16_T</code> (uint16)	<code>int8_T</code> (int8)	<code>int32_T</code> (int32)

Description

The `ocvCvRectToBoundingBox_{DataType}` function converts `vector<cv::Rect>` to an *M*-by-4 mxArray of bounding boxes.

See Also

`mxArray`, `ocvCvBox2DToMxArray`, “C Matrix API”, “C MEX File Applications”

Introduced in R2015a

ocvCvBox2DToMxArray

Convert OpenCV CvBox2D to a MATLAB struct

C++ Syntax

```
#include "opencvmex.hpp"  
mxArray *ocvCvBox2DToMxArray(const CvBox2D *in);
```

Arguments

in

Pointer to OpenCV CvBox2D.

Returns

Pointer to a MATLAB structure, `mxArray`, that represents a rectangle. The structure must have five scalar-valued fields: `x_center`, `y_center`, `width`, `height`, and `angle`. The (`x_center`, `y_center`) fields represent the center of the rectangle.

Description

The `ocvCvBox2DToMxArray` function converts a rectangle data structure from an OpenCV CvBox2D to a MATLAB struct.

See Also

`mxArray`, `ocvCvRectToBoundingBox_{DataType}`, “C Matrix API”, “C MEX File Applications”

Introduced in R2015a

ocvCheckFeaturePointsStruct

Check that MATLAB struct represents feature points

C++ Syntax

```
#include "opencvmex.hpp"
void ocvCheckFeaturePointsStruct(const mxArray *in);
```

Arguments

in

Pointer to a MATLAB structure, mxArray, that represents point feature. Format:

Field Name	Field Requirement	Field Data Type
Location	Required	Single
Scale	Required	Single
Metric	Required	Single
Orientation	Optional	Single
Octave	Optional	int32
Misc	Optional	int32

Description

The ocvCheckFeaturePointsStruct function performs the key point struct checker.

See Also

mxArrayocvStructToKeyPoints, ocvKeyPointsToStruct, "C Matrix API", "C MEX File Applications"

Introduced in R2015a

createMat

Create MATLAB interface object for OpenCV Mat class

Syntax

```
[ocvMat,ocvInputArray] = createMat(img)
[ocvMat,ocvArray] = createMat(img,arrayType)
[ocvMat,ocvOutputArray] = createMat
[ocvMat,ocvArray] = createMat(arrayType)
```

Description

`[ocvMat,ocvInputArray] = createMat(img)` creates the MATLAB interface objects for the OpenCV Mat class and the associated InputArray class. Use these interface objects to pass an image as input to the OpenCV functions.

`[ocvMat,ocvArray] = createMat(img,arrayType)` creates the MATLAB interface objects for the OpenCV Mat class and the associated InputArray, OutputArray, or InputOutputArray class specified by arrayType.

`[ocvMat,ocvOutputArray] = createMat` creates an empty interface object for the OpenCV Mat class and the associated OutputArray class. Use this interface to write the output returned by an OpenCV function.

`[ocvMat,ocvArray] = createMat(arrayType)` creates an empty interface object for the OpenCV Mat class and the associated InputArray, OutputArray, or InputOutputArray class specified by arrayType.

Examples

Create MATLAB Interface Object for OpenCV Mat and Associated Array Classes

Add the prebuilt MATLAB interface to OpenCV package name to the import list.

```
import vision.opencv.util.*
```

Create MATLAB Interface Object for OpenCV Mat and InputArray Class

Read an image into the MATLAB workspace.

```
img = imread("cameraman.tif");
```

Create a MATLAB interface object for the OpenCV Mat class and store the image data. The function also creates an interface object for the OpenCV InputArray class that is constructed from the Mat class.

```
[ocvMat,ocvArray] = createMat(img);
```

Display and inspect the properties of the MATLAB interface object for the OpenCV Mat class.

```
ocvMat
```

```
ocvMat =  
  MatND with properties:  
  
  flags: 1124024320  
  dims: 2  
  rows: 256  
  cols: 256  
  size: [1x1 clib.opencv.cv.MatSize]  
  step: [1x1 clib.opencv.cv.MatStep]
```

Inspect the type of array class returned by the function.

```
ocvArray
```

```
ocvArray =  
  x_InputArray with no properties.
```

Use the `getImage` utility function to read the image stored in the `InputArray` class. Display the image.

```
outImg = getImage(ocvArray);  
figure  
imshow(outImg)
```



Create MATLAB Interface Object for OpenCV Mat and OutputArray Classes

Add the prebuilt MATLAB interface to OpenCV package name to the import list.

```
import vision.opencv.util.*
```

Create a MATLAB interface object for the OpenCV `Mat` class. The function also creates an interface object for the OpenCV `OutputArray` class that is constructed from the `Mat` class.

```
[ocvMat,ocvArray] = createMat;
```

Display and inspect the properties of the MATLAB interface object for the OpenCV `Mat` class.

`ocvMat`

```
ocvMat =  
  MatND with properties:  
  
  flags: 1124007936  
  dims: 0  
  rows: 0  
  cols: 0  
  size: [1x1 clib.opencv.cv.MatSize]  
  step: [1x1 clib.opencv.cv.MatStep]
```

Inspect the type of array class returned by the function.

`ocvArray`

```
ocvArray =  
  x_OutputArray with no properties.
```

Specify Array Class to Construct from OpenCV Mat Class

Add the prebuilt MATLAB interface to OpenCV package name to the import list.

```
import vision.opencv.util.*
```

Read an image into the MATLAB workspace.

```
img = imread("cameraman.tif");
```

Create a MATLAB interface object for the OpenCV `Mat` class. Specify the array type as "InputOutput" for the function to construct the OpenCV `InputOutputArray` class from the `Mat` class.

```
arrayType = "InputOutput";  
[ocvMat,ocvArray] = createMat(img,arrayType);
```

Display and inspect the properties of the MATLAB interface object for the OpenCV `Mat` class.

`ocvMat`

```
ocvMat =  
  MatND with properties:  
  
  flags: 1124024320  
  dims: 2  
  rows: 256  
  cols: 256  
  size: [1x1 clib.opencv.cv.MatSize]  
  step: [1x1 clib.opencv.cv.MatStep]
```

Inspect the type of array class returned by the function.

```
ocvArray
```

```
ocvArray =  
    x_InputOutputArray with no properties.
```

Input Arguments

img — Input image

M-by-*N* matrix | *M*-by-*N*-by-3 array

Input image, specified as an *M*-by-*N* matrix representing an intensity image or *M*-by-*N*-by-3 array representing a color image.

Data Types: `single` | `double` | `int8` | `int16` | `int32` | `uint8` | `uint16`

arrayType — Type of array

"Input" | "Output" | "InputOutput"

Type of array to associate with the MATLAB interface object for the OpenCV `Mat` class, specified as "Input", "Output", or "InputOutput".

Data Types: `char` | `string`

Output Arguments

ocvMat — *n*-dimensional dense array class

`MatND` interface object

n-dimensional dense array class, returned as a `MatND` interface object. This interface object is a representation of the OpenCV class `cv::Mat`.

ocvInputArray — Proxy class for passing inputs

`InputArray` interface object

Proxy class for passing inputs to OpenCV functions, returned as an `InputArray` interface object. This interface object is a representation of the OpenCV class `cv::_InputArray`.

ocvArray — Proxy class for inputs or outputs

`InputArray` interface object | `InputOutputArray` interface object | `OutputArray` interface object

Proxy class for inputs or outputs, returned as one of these values:

- `InputArray` interface object — This MATLAB interface object is a representation of the OpenCV class `cv::_InputArray`. This value is returned if `arrayType` is specified as "Input".
- `InputOutputArray` interface object — This MATLAB interface object is a representation of the OpenCV class `cv::_InputOutputArray`. This value is returned if `arrayType` is specified as "InputOutput".
- `OutputArray` interface object — This MATLAB interface object is a representation of the OpenCV class `cv::_OutputArray`. This value is returned if `arrayType` is specified as "Output".

ocvOutputArray — Proxy class for writing output

`OutputArray` interface object

Proxy class for writing outputs from OpenCV functions, returned as an `OutputArray` interface object. This MATLAB interface object is a representation of the OpenCV class `cv::_OutputArray`.

See Also

`createUMat` | `getImage` | `getBasePtr` | `keyPointsToStruct` | `rectToBbox`

Topics

“Use Prebuilt MATLAB Interface to OpenCV”

Introduced in R2021b

createUMat

Create MATLAB interface object for OpenCV UMat class

Syntax

```
[ocvUMat,ocvInputArray] = createUMat(img)
[ocvUMat,ocvArray] = createUMat(img,arrayType)
[ocvUMat,ocvOutputArray] = createUMat
[ocvUMat,ocvArray] = createUMat(arrayType)
```

Description

`[ocvUMat,ocvInputArray] = createUMat(img)` creates the MATLAB interface objects for the OpenCV UMat class and the associated InputArray class. Use these interface objects to pass an image as input to the OpenCV functions.

`[ocvUMat,ocvArray] = createUMat(img,arrayType)` creates the MATLAB interface objects for the OpenCV UMat class and the associated InputArray, OutputArray, or InputOutputArray class specified by arrayType.

`[ocvUMat,ocvOutputArray] = createUMat` creates an empty interface object for the OpenCV UMat class and the associated OutputArray class. Use this interface to write the output returned by an OpenCV function.

`[ocvUMat,ocvArray] = createUMat(arrayType)` creates an empty interface object for the OpenCV UMat class and the associated InputArray, OutputArray, or InputOutputArray class specified by arrayType.

Examples

Create MATLAB Interface Object for OpenCV UMat and Associated Array Classes

Add the prebuilt MATLAB interface to OpenCV package name to the import list.

```
import vision.opencv.util.*
```

Create MATLAB Interface Object for OpenCV UMat and InputArray Class

Read an image into the MATLAB workspace.

```
img = imread("cameraman.tif");
```

Create a MATLAB interface object for the OpenCV UMat class and store the image data. The function also creates an interface object for the OpenCV InputArray class that is constructed from the UMat class.

```
[ocvMat,ocvArray] = createUMat(img);
```

Display and inspect the properties of the MATLAB interface object for the OpenCV UMat class.

`ocvMat`

```
ocvMat =  
  UMat with properties:  
  
    flags: 1124024320  
    dims: 2  
    rows: 256  
    cols: 256  
  usageFlags: USAGE_DEFAULT  
  offset: 0  
  size: [1x1 clib.opencv.cv.MatSize]  
  step: [1x1 clib.opencv.cv.MatStep]
```

Inspect the type of array class returned by the function.

`ocvArray`

```
ocvArray =  
  x_InputArray with no properties.
```

Use the `getImage` utility function to read the image stored in the `InputArray` class. Display the image.

```
outImg = getImage(ocvArray);  
figure  
imshow(outImg)
```



Create MATLAB Interface Object for OpenCV `UMat` and `OutputArray` Classes

Add the prebuilt MATLAB interface to OpenCV package name to the import list.

```
import vision.opencv.util.*
```

Create a MATLAB interface object for the OpenCV `UMat` class. The function also creates an interface object for the OpenCV `OutputArray` class that is constructed from the `UMat` class.

```
[ocvMat,ocvArray] = createUMat;
```

Display and inspect the properties of the MATLAB interface object for the OpenCV `UMat` class.

```
ocvMat
```

```
ocvMat =
    UMat with properties:

        flags: 1124007936
         dims: 0
         rows: 0
         cols: 0
    usageFlags: USAGE_DEFAULT
         offset: 0
         size: [1x1 clib.opencv.cv.MatSize]
         step: [1x1 clib.opencv.cv.MatStep]
```

Inspect the type of array class returned by the function.

```
ocvArray
```

```
ocvArray =
    x_OutputArray with no properties.
```

Specify Array Class to Construct from OpenCV `UMat` Class

Add the prebuilt MATLAB interface to OpenCV package name to the import list.

```
import vision.opencv.util.*
```

Read an image into the MATLAB workspace.

```
img = imread("cameraman.tif");
```

Create a MATLAB interface object for the OpenCV `UMat` class. Specify the array type as "InputOutput" for the function to construct the OpenCV `InputOutputArray` class from the `UMat` class.

```
arrayType = "InputOutput";
[ocvMat,ocvArray] = createUMat(img,arrayType);
```

Display and inspect the properties of the MATLAB interface object for the OpenCV `UMat` class.

```
ocvMat
```

```
ocvMat =
    UMat with properties:

        flags: 1124024320
         dims: 2
         rows: 256
```

```

        cols: 256
    usageFlags: USAGE_DEFAULT
    offset: 0
    size: [1x1 clib.opencv.cv.MatSize]
    step: [1x1 clib.opencv.cv.MatStep]

```

Inspect the type of array class returned by the function.

```
ocvArray
```

```
ocvArray =
    x_InputOutputArray with no properties.
```

Input Arguments

img — Input image

M-by-*N* matrix | *M*-by-*N*-by-3 array

Input image, specified as an *M*-by-*N* matrix representing an intensity image or *M*-by-*N*-by-3 array representing a color image.

Data Types: `single` | `double` | `int8` | `int16` | `int32` | `uint8` | `uint16`

arrayType — Type of array

"Input" | "Output" | "InputOutput"

Type of array to associate with the MATLAB interface object for OpenCV `UMat` class, specified as : "Input", "Output", or "InputOutput".

Data Types: `char` | `string`

Output Arguments

ocvUMat — Unified *n*-dimensional dense array class

`UMat` interface object

Unified *n*-dimensional dense array class, returned as a `UMat` interface object. This MATLAB interface object is a representation of the OpenCV class `cv::UMat`.

ocvInputArray — Proxy class for passing inputs

`InputArray` interface object

Proxy class for passing inputs to OpenCV functions, returned as an `InputArray` interface object. This MATLAB interface object is a representation of the OpenCV class `cv::_InputArray`.

ocvArray — Proxy class for inputs or outputs

`InputArray` interface object | `InputOutputArray` interface object | `OutputArray` interface object

Proxy class for inputs or outputs, returned as one of these values:

- `InputArray` interface object — This MATLAB interface object is a representation of the OpenCV class `cv::_InputArray`. This value is returned if `arrayType` is specified as "Input".

- `InputOutputArray` interface object — This MATLAB interface object is a representation of the OpenCV class, `cv::_InputOutputArray`. This value is returned if `arrayType` is specified as "InputOutput".
- `OutputArray` interface object — This MATLAB interface object is a representation of the OpenCV class `cv::_OutputArray`. This value is returned if `arrayType` is specified as "Output".

ocvOutputArray — Proxy class for writing output

`OutputArray` interface object

Proxy class for writing outputs from OpenCV functions, returned as an `OutputArray` interface object. This MATLAB interface object is a representation of the OpenCV class `cv::_OutputArray`.

See Also

`rectToBbox` | `getImage` | `getBasePtr` | `createMat` | `keyPointsToStruct`

Topics

"Use Prebuilt MATLAB Interface to OpenCV"

Introduced in R2021b

getBasePtr

Package: vision.opencv.util

Create MATLAB interface object for OpenCV base class

Syntax

```
output = getBasePtr(ptr)
```

Description

`output = getBasePtr(ptr)` creates a MATLAB interface object for an OpenCV base class pointed by a smart pointer `ptr`. You can use the interface object to access the public member functions and public attributes of an OpenCV base class directly from MATLAB.

Examples

Perform Histogram Equalization by Using OpenCV in MATLAB

Perform histogram equalization of an image by using the prebuilt MATLAB interface to the OpenCV function `cv::CLAHE`. The `cv::CLAHE` function is a base class, and you must create a MATLAB interface object by using the `getBasePtr` utility function to access the public methods and attributes of the base class.

Add the MATLAB interface to OpenCV package names to the import list.

```
import clib.opencv.*;
import vision.opencv.util.*;
```

Read an image into the MATLAB workspace.

```
img = imread("cameraman.tif");
```

Create the MATLAB interface objects for the OpenCV `MatND` and `InputArray` classes to store the input image.

```
[inputMat,inputArray] = createMat(img);
```

Create the MATLAB interface objects for the OpenCV `MatND` and `OutputArray` classes to write the output image returned by the OpenCV function.

```
[outputMat,outputArray] = createMat;
```

Create a MATLAB interface object to represent the smart pointer of the OpenCV `CLAHE` class `cv::CLAHE`.

```
ocvPtr = cv.createCLAHE;
```

Create a MATLAB interface object for the base class `cv::CLAHE`.

```
basePtr = getBasePtr(ocvPtr);
```

Set the value of clip limit to 4.

```
basePtr.setClipLimit(4);
```

Perform contrast-limited adaptive histogram equalization by using the `apply` method of the `cv::CLAHE` base class.

```
basePtr.apply(inputArray,outputArray);
```

Read the enhanced output image.

```
enhanced = getImage(outputArray);
```

Display the original input and the enhanced output image.

```
figure  
imshow(img)  
title("Input Image")
```

Input Image



```
figure  
imshow(enhanced)  
title("Enhanced Image")
```

Enhanced Image

Input Arguments

ptr — OpenCV smart pointer

`Ptr_cv_<_T>` interface object

OpenCV smart pointer, specified as a `Ptr_cv_<_T>` interface object. This MATLAB interface object is a representation of an OpenCV smart pointer `cv::Ptr<_T>`.

Output Arguments

output — Representation of OpenCV base class

MATLAB interface object

Representation of OpenCV base class, returned as a MATLAB interface object. You can use the object to directly access the public member functions and public attributes of an OpenCV base class.

See Also

`rectToBbox` | `getImage` | `createMat` | `keyPointsToStruct` | `createUMat`

Topics

“Use Prebuilt MATLAB Interface to OpenCV”

Introduced in R2021b

getImage

Package: vision.opencv.util

Read images stored in MATLAB interface object for OpenCV class

Syntax

```
outputImg = getImage(ocvInput)
```

Description

`outputImg = getImage(ocvInput)` reads the image stored in a MATLAB interface object for an OpenCV class and writes it to the specified output variable `outputImg` in the MATLAB workspace.

Examples

Read Image Stored in OpenCV Mat Class

Add the MATLAB interface to OpenCV package names to the import list.

```
import clib.opencv.*  
import vision.opencv.util.*
```

Read an image into the MATLAB workspace.

```
img = imread("cameraman.tif");
```

Create a MATLAB interface object for the OpenCV InputOutput array class.

```
[ocvMat,ocvArray] = createMat(img);
```

Read the image stored in the InputOutput interface object.

```
output = getImage(ocvArray);
```

Display the output image.

```
figure  
imshow(output)
```



Input Arguments

ocvInput — MATLAB interface object for OpenCV class

MatND interface object | UMat interface object | InputArray interface object | InputOutputArray interface object | OutputArray interface object

MATLAB interface object for an OpenCV class, specified as one of these values:

- **MatND** interface object — Created by using the `createMat` function and represents the OpenCV `cv::Mat` class.
- **UMat** interface object — Created by using the `createUMat` function and represents the OpenCV `cv::UMat` class.
- **InputArray** interface object — Created by using the `createMat` or `createUMat` function and represents the OpenCV `cv::_InputArray` class. The **InputArray** interface object passes array inputs to the OpenCV functions.
- **InputOutputArray** interface object — Created by using the `createMat` or `createUMat` function and represents the OpenCV `cv::_InputOutputArray` class. The **InputOutputArray** interface object passes array inputs to the OpenCV functions and writes the array outputs returned by the OpenCV functions.
- **OutputArray** interface object — Created by using the `createMat` or `createUMat` function and represents the OpenCV `cv::_OutputArray` class. The **OutputArray** interface object contains the array outputs returned by the OpenCV functions.

Output Arguments

outputImg — Output image

M -by- N matrix | M -by- N -by-3 array

Output image read from a MATLAB interface object, returned as an M -by- N matrix for intensity images and M -by- N -by-3 array for color images.

See Also

`createMat` | `createUMat`

Topics

“Use Prebuilt MATLAB Interface to OpenCV”

Introduced in R2021b

keyPointsToStruct

Package: vision.opencv.util

Convert OpenCV KeyPoints object to MATLAB structure

Syntax

```
mlstruct = keyPointsToStruct(keypoints)
```

Description

`mlstruct = keyPointsToStruct(keypoints)` converts an OpenCV KeyPoints object to a MATLAB structure.

Examples

Detect Keypoints in Image Using OpenCV in MATLAB

This example shows how to use the prebuilt MATLAB interface for the OpenCV function `cv::Fast` in MATLAB to detect keypoints in an image. Additionally, use the `keyPointsToStruct` utility function to write the keypoints returned by the OpenCV `cv::Fast` function to a MATLAB structure.

Add the MATLAB interface to OpenCV package names to the import list.

```
import clib.opencv.*;  
import vision.opencv.util.*;
```

Read an image into the MATLAB workspace.

```
img = imread("elephant.jpg");
```

Create MATLAB interface objects for the OpenCV `MatND` and `InputArray` classes to store the input image.

```
[inputMat,inputArray] = createMat(img);
```

Create a MATLAB interface object for the OpenCV `KeyPoint` vector by using the `clibArray` function.

```
keyPointsVec = clibArray("clib.opencv.cv.KeyPoint",0);
```

Specify the parameters for computing keypoints using the FAST detector.

```
threshold = 100;  
nonmaxSuppression = true;
```

Compute keypoints in the image by calling the OpenCV function `cv::FAST` in MATLAB.

```
cv.FAST(inputArray,keyPointsVec,threshold,nonmaxSuppression);
```

Convert the `KeyPoints` object returned by the OpenCV function into a MATLAB structure.

```
mlstruct = keyPointsToStruct(keyPointsVec);
```

Inspect the fields in the output MATLAB structure.

```
mlstruct
```

```
mlstruct = struct with fields:  
  Location: [48x2 double]  
  Scale: [48x1 double]  
  Metric: [48x1 double]  
  Misc: [48x1 double]  
  Orientation: [48x1 double]
```

Display the input image and plot the detected keypoints.

```
figure  
imshow(img)  
hold on  
plot(mlstruct.Location(:,1),mlstruct.Location(:,2),"*r")  
hold off
```



Input Arguments

keypoints — OpenCV KeyPoints class

MATLAB interface object

OpenCV KeyPoints class, specified as a MATLAB interface object. This interface object is a representation of the KeyPoints class returned by any of the OpenCV functions for keypoint detection.

Output Arguments

mlstruct — Keypoints detected using OpenCV function

structure

Keypoints detected using the OpenCV function, returned as a MATLAB structure with fields Location, Scale, Metric, Misc, and Orientation.

Fields	Description
Location	x and y-coordinates of the keypoints.
Scale	Diameter of the neighborhood region around the keypoints.
Metric	Strength of the keypoints.
Orientation	Orientation of the keypoints.

See Also

[rectToBbox](#) | [getImage](#) | [getBasePtr](#) | [createUMat](#) | [createMat](#) | [clibArray](#)

Topics

“Use Prebuilt MATLAB Interface to OpenCV”

Introduced in R2021b

rectToBbox

Package: vision.opencv.util

Compute bounding boxes from outputs returned by MATLAB interface object for OpenCV Rect class

Syntax

```
bbox = rectToBbox(input)
```

Description

`bbox = rectToBbox(input)` computes bounding box values from the outputs returned by a MATLAB interface object for OpenCV Rect class. The OpenCV Rect class creates rectangles on an input image. This function maps the zero-based indexing in OpenCV to one-based indexing in MATLAB.

Examples

Draw Rectangle on Image Using OpenCV in MATLAB

Draw a rectangle on an image by using the prebuilt MATLAB interface for the OpenCV function `cv::rectangle`. Compute the corresponding bounding box values in MATLAB to use to crop the image region.

Add the MATLAB interface to OpenCV package names to the import list.

```
import clib.opencv.*;  
import vision.opencv.util.*;
```

Read an image into the MATLAB workspace.

```
img = imread("highway.png");
```

Create interface objects for the OpenCV Mat and InputOutputArray classes to store the input image.

```
[inputMat,ocvArray] = createMat(img,"InputOutput");
```

Define Rectangular Region

Call the OpenCV function `cv::Rect2i` using MATLAB, and specify the coordinates and dimensions for the rectangle. Display the values.

```
rec = cv.Rect2i(140,60,100,100)
```

```
rec =  
  Rect2i with properties:
```

```
    x: 140  
    y: 60  
  width: 100
```

```
height: 100
```

Draw Rectangle and Display Results

Specify the properties of the line to use for drawing the rectangle. Set these values:

- Color of the line to red. To set this value, use the OpenCV function `cv::Scalar`.
- Thickness of the line to 2.
- Line type to 4.
- Shift to 0.

```
color = cv.Scalar(255,0,0);  
thickness = 2;  
lineType = 4;  
shift = 0;
```

Draw the defined rectangle on the image by using the OpenCV function `cv::rectangle`.

```
cv.rectangle(ocvArray,rec,color,thickness,lineType,shift);
```

Read and display the output image.

```
outputImg = getImage(ocvArray);  
figure  
imshow(outputImg)
```

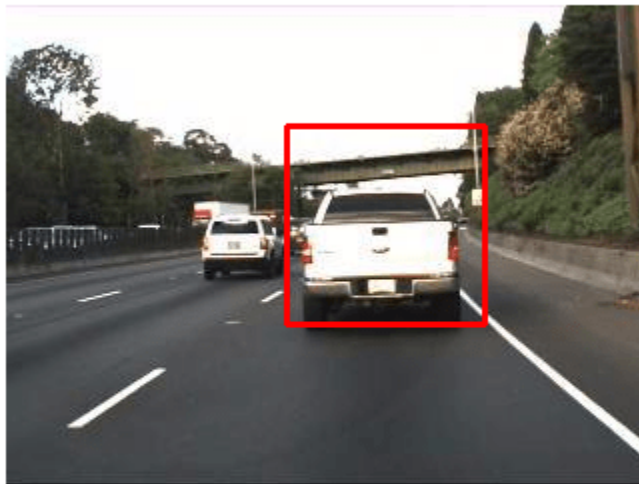

Compute Bounding Box

Use the utility function `rectToBbox` to compute the bounding box value from the values returned by OpenCV function `cv::Rect2i`.

```
bbox = rectToBbox(rec);
```

Display the bounding box values. Notice that the bounding box values in the MATLAB workspace have one-based indexing.

```
bbox
```

```
bbox = 1x4 int32 row vector
    141    61   100   100
```

Crop the region within the bounding box by using the `imcrop` function and display the cropped image.

```
croppedImg = imcrop(img,bbox);
figure
imshow(croppedImg)
```



Input Arguments

input — OpenCV class for rectangles

Rect_unsignedChar_ interface object | Rect2d interface object | Rect2f interface object | Rect2i interface object

OpenCV class for rectangles, specified as one of these values:

- Rect_unsignedChar_ interface object — This MATLAB interface object is a representation of the OpenCV class `cv::Rect_<unsigned char>`.
- Rect2d interface object — This MATLAB interface object is a representation of the OpenCV class `cv::Rect_<double>`.
- Rect2f interface object — This MATLAB interface object is a representation of the OpenCV class `cv::Rect_<float>`.
- Rect2i interface object — This MATLAB interface object is a representation of the OpenCV class `cv::Rect_<int>`.
- Rect2i interface object — This MATLAB interface object is a representation of the OpenCV class `cv::Rect_<int>`.

Output Arguments

bbox — Bounding box values

four-element row vector

Bounding box values, returned as a four-element row vector of the form [x y width height].

See Also

[createMat](#) | [getImage](#) | [createUMat](#) | [getBasePtr](#)

Topics

“Use Prebuilt MATLAB Interface to OpenCV”

Introduced in R2021b

trainSSDObjectDetector

Train an SSD deep learning object detector

Syntax

```
trainedDetector = trainSSDObjectDetector(trainingData,lgraph,options)
[trainedDetector,info] = trainSSDObjectDetector( ___ )

trainedDetector = trainSSDObjectDetector(trainingData,checkpoint,options)

trainedDetector = trainSSDObjectDetector(trainingData,detector,options)

trainedDetector = trainSSDObjectDetector( ___,Name,Value)
```

Description

Train a Detector

`trainedDetector = trainSSDObjectDetector(trainingData,lgraph,options)` trains a single shot multibox detector (SSD) using deep learning. You can train an SSD detector to detect multiple object classes.

This function requires that you have Deep Learning Toolbox. It is recommended that you also have Parallel Computing Toolbox to use with a CUDA-enabled NVIDIA GPU. For information about the supported compute capabilities, see “GPU Support by Release” (Parallel Computing Toolbox).

`[trainedDetector,info] = trainSSDObjectDetector(___)` also returns information on the training progress, such as training loss and accuracy, for each iteration.

Resume Training a Detector

`trainedDetector = trainSSDObjectDetector(trainingData,checkpoint,options)` resumes training from a detector checkpoint.

Fine-Tune a Detector

`trainedDetector = trainSSDObjectDetector(trainingData,detector,options)` continues training an SSD multibox object detector with additional fine-tuning options. Use this syntax with additional training data or to perform more training iterations to improve detector accuracy.

Additional Properties

`trainedDetector = trainSSDObjectDetector(___,Name,Value)` uses additional options specified by one or more `Name,Value` pair arguments and any of the previous inputs.

Examples

Train SSD Object Detector

Load the training data for vehicle detection into the workspace.

```
data = load('vehicleTrainingData.mat');
trainingData = data.vehicleTrainingData;
```

Specify the directory in which training samples are stored. Add full path to the file names in training data.

```
dataDir = fullfile(toolboxdir('vision'),'visiondata');
trainingData.imageFilename = fullfile(dataDir,trainingData.imageFilename);
```

Create an image datastore using the files from the table.

```
imds = imageDatastore(trainingData.imageFilename);
```

Create a box label datastore using the label columns from the table.

```
blds = boxLabelDatastore(trainingData(:,2:end));
```

Combine the datastores.

```
ds = combine(imds,blds);
```

Load a preinitialized SSD object detection network.

```
net = load('ssdVehicleDetector.mat');
lgraph = net.lgraph
```

```
lgraph =
  LayerGraph with properties:
    Layers: [132x1 nnet.cnn.layer.Layer]
  Connections: [141x2 table]
  InputNames: {'input_1'}
  OutputNames: {'focal_loss' 'rcnnboxRegression'}
```

Inspect the layers in the SSD network and their properties. You can also create the SSD network by following the steps given in “Create SSD Object Detection Network”.

`lgraph.Layers`

```
ans =
  132x1 Layer array with layers:

   1  'input_1'           Image Input           224x224x3 images with 'zscore'
   2  'Conv1'            Convolution           32 3x3x3 convolutions with 'zscore'
   3  'bn_Conv1'         Batch Normalization   Batch normalization with 32
   4  'Conv1_relu'       Clipped ReLU          Clipped ReLU with ceiling 6
   5  'expanded_conv_depthwise' Grouped Convolution   32 groups of 1 3x3x1 convolutions
   6  'expanded_conv_depthwise_BN' Batch Normalization   Batch normalization with 32
   7  'expanded_conv_depthwise_relu' Clipped ReLU          Clipped ReLU with ceiling 6
   8  'expanded_conv_project' Convolution           16 1x1x32 convolutions with 'zscore'
   9  'expanded_conv_project_BN' Batch Normalization   Batch normalization with 16
  10  'block_1_expand'   Convolution           96 1x1x16 convolutions with 'zscore'
  11  'block_1_expand_BN' Batch Normalization   Batch normalization with 96
  12  'block_1_expand_relu' Clipped ReLU          Clipped ReLU with ceiling 6
  13  'block_1_depthwise' Grouped Convolution   96 groups of 1 3x3x1 convolutions
  14  'block_1_depthwise_BN' Batch Normalization   Batch normalization with 96
  15  'block_1_depthwise_relu' Clipped ReLU          Clipped ReLU with ceiling 6
  16  'block_1_project'  Convolution           24 1x1x96 convolutions with 'zscore'
```

17	'block_1_project_BN'	Batch Normalization	Batch normalization with 24
18	'block_2_expand'	Convolution	144 1x1x24 convolutions with
19	'block_2_expand_BN'	Batch Normalization	Batch normalization with 144
20	'block_2_expand_relu'	Clipped ReLU	Clipped ReLU with ceiling 6
21	'block_2_depthwise'	Grouped Convolution	144 groups of 1 3x3x1 convo
22	'block_2_depthwise_BN'	Batch Normalization	Batch normalization with 144
23	'block_2_depthwise_relu'	Clipped ReLU	Clipped ReLU with ceiling 6
24	'block_2_project'	Convolution	24 1x1x144 convolutions with
25	'block_2_project_BN'	Batch Normalization	Batch normalization with 24
26	'block_2_add'	Addition	Element-wise addition of 2
27	'block_3_expand'	Convolution	144 1x1x24 convolutions with
28	'block_3_expand_BN'	Batch Normalization	Batch normalization with 144
29	'block_3_expand_relu'	Clipped ReLU	Clipped ReLU with ceiling 6
30	'block_3_depthwise'	Grouped Convolution	144 groups of 1 3x3x1 convo
31	'block_3_depthwise_BN'	Batch Normalization	Batch normalization with 144
32	'block_3_depthwise_relu'	Clipped ReLU	Clipped ReLU with ceiling 6
33	'block_3_project'	Convolution	32 1x1x144 convolutions with
34	'block_3_project_BN'	Batch Normalization	Batch normalization with 32
35	'block_4_expand'	Convolution	192 1x1x32 convolutions with
36	'block_4_expand_BN'	Batch Normalization	Batch normalization with 192
37	'block_4_expand_relu'	Clipped ReLU	Clipped ReLU with ceiling 6
38	'block_4_depthwise'	Grouped Convolution	192 groups of 1 3x3x1 convo
39	'block_4_depthwise_BN'	Batch Normalization	Batch normalization with 192
40	'block_4_depthwise_relu'	Clipped ReLU	Clipped ReLU with ceiling 6
41	'block_4_project'	Convolution	32 1x1x192 convolutions with
42	'block_4_project_BN'	Batch Normalization	Batch normalization with 32
43	'block_4_add'	Addition	Element-wise addition of 2
44	'block_5_expand'	Convolution	192 1x1x32 convolutions with
45	'block_5_expand_BN'	Batch Normalization	Batch normalization with 192
46	'block_5_expand_relu'	Clipped ReLU	Clipped ReLU with ceiling 6
47	'block_5_depthwise'	Grouped Convolution	192 groups of 1 3x3x1 convo
48	'block_5_depthwise_BN'	Batch Normalization	Batch normalization with 192
49	'block_5_depthwise_relu'	Clipped ReLU	Clipped ReLU with ceiling 6
50	'block_5_project'	Convolution	32 1x1x192 convolutions with
51	'block_5_project_BN'	Batch Normalization	Batch normalization with 32
52	'block_5_add'	Addition	Element-wise addition of 2
53	'block_6_expand'	Convolution	192 1x1x32 convolutions with
54	'block_6_expand_BN'	Batch Normalization	Batch normalization with 192
55	'block_6_expand_relu'	Clipped ReLU	Clipped ReLU with ceiling 6
56	'block_6_depthwise'	Grouped Convolution	192 groups of 1 3x3x1 convo
57	'block_6_depthwise_BN'	Batch Normalization	Batch normalization with 192
58	'block_6_depthwise_relu'	Clipped ReLU	Clipped ReLU with ceiling 6
59	'block_6_project'	Convolution	64 1x1x192 convolutions with
60	'block_6_project_BN'	Batch Normalization	Batch normalization with 64
61	'block_7_expand'	Convolution	384 1x1x64 convolutions with
62	'block_7_expand_BN'	Batch Normalization	Batch normalization with 384
63	'block_7_expand_relu'	Clipped ReLU	Clipped ReLU with ceiling 6
64	'block_7_depthwise'	Grouped Convolution	384 groups of 1 3x3x1 convo
65	'block_7_depthwise_BN'	Batch Normalization	Batch normalization with 384
66	'block_7_depthwise_relu'	Clipped ReLU	Clipped ReLU with ceiling 6
67	'block_7_project'	Convolution	64 1x1x384 convolutions with
68	'block_7_project_BN'	Batch Normalization	Batch normalization with 64
69	'block_7_add'	Addition	Element-wise addition of 2
70	'block_8_expand'	Convolution	384 1x1x64 convolutions with
71	'block_8_expand_BN'	Batch Normalization	Batch normalization with 384
72	'block_8_expand_relu'	Clipped ReLU	Clipped ReLU with ceiling 6
73	'block_8_depthwise'	Grouped Convolution	384 groups of 1 3x3x1 convo
74	'block_8_depthwise_BN'	Batch Normalization	Batch normalization with 384

75	'block_8_depthwise_relu'	Clipped ReLU	Clipped ReLU with ceiling 6
76	'block_8_project'	Convolution	64 1x1x384 convolutions with
77	'block_8_project_BN'	Batch Normalization	Batch normalization with 64
78	'block_8_add'	Addition	Element-wise addition of 2
79	'block_9_expand'	Convolution	384 1x1x64 convolutions with
80	'block_9_expand_BN'	Batch Normalization	Batch normalization with 384
81	'block_9_expand_relu'	Clipped ReLU	Clipped ReLU with ceiling 6
82	'block_9_depthwise'	Grouped Convolution	384 groups of 1 3x3x1 convo
83	'block_9_depthwise_BN'	Batch Normalization	Batch normalization with 384
84	'block_9_depthwise_relu'	Clipped ReLU	Clipped ReLU with ceiling 6
85	'block_9_project'	Convolution	64 1x1x384 convolutions with
86	'block_9_project_BN'	Batch Normalization	Batch normalization with 64
87	'block_9_add'	Addition	Element-wise addition of 2
88	'block_10_expand'	Convolution	384 1x1x64 convolutions with
89	'block_10_expand_BN'	Batch Normalization	Batch normalization with 384
90	'block_10_expand_relu'	Clipped ReLU	Clipped ReLU with ceiling 6
91	'block_10_depthwise'	Grouped Convolution	384 groups of 1 3x3x1 convo
92	'block_10_depthwise_BN'	Batch Normalization	Batch normalization with 384
93	'block_10_depthwise_relu'	Clipped ReLU	Clipped ReLU with ceiling 6
94	'block_10_project'	Convolution	96 1x1x384 convolutions with
95	'block_10_project_BN'	Batch Normalization	Batch normalization with 96
96	'block_11_expand'	Convolution	576 1x1x96 convolutions with
97	'block_11_expand_BN'	Batch Normalization	Batch normalization with 576
98	'block_11_expand_relu'	Clipped ReLU	Clipped ReLU with ceiling 6
99	'block_11_depthwise'	Grouped Convolution	576 groups of 1 3x3x1 convo
100	'block_11_depthwise_BN'	Batch Normalization	Batch normalization with 576
101	'block_11_depthwise_relu'	Clipped ReLU	Clipped ReLU with ceiling 6
102	'block_11_project'	Convolution	96 1x1x576 convolutions with
103	'block_11_project_BN'	Batch Normalization	Batch normalization with 96
104	'block_11_add'	Addition	Element-wise addition of 2
105	'block_12_expand'	Convolution	576 1x1x96 convolutions with
106	'block_12_expand_BN'	Batch Normalization	Batch normalization with 576
107	'block_12_expand_relu'	Clipped ReLU	Clipped ReLU with ceiling 6
108	'block_12_depthwise'	Grouped Convolution	576 groups of 1 3x3x1 convo
109	'block_12_depthwise_BN'	Batch Normalization	Batch normalization with 576
110	'block_12_depthwise_relu'	Clipped ReLU	Clipped ReLU with ceiling 6
111	'block_12_project'	Convolution	96 1x1x576 convolutions with
112	'block_12_project_BN'	Batch Normalization	Batch normalization with 96
113	'block_12_add'	Addition	Element-wise addition of 2
114	'block_13_expand'	Convolution	576 1x1x96 convolutions with
115	'block_13_expand_BN'	Batch Normalization	Batch normalization with 576
116	'block_13_expand_relu'	Clipped ReLU	Clipped ReLU with ceiling 6
117	'block_13_depthwise'	Grouped Convolution	576 groups of 1 3x3x1 convo
118	'block_13_depthwise_BN'	Batch Normalization	Batch normalization with 576
119	'block_13_depthwise_relu'	Clipped ReLU	Clipped ReLU with ceiling 6
120	'block_13_project'	Convolution	160 1x1x576 convolutions with
121	'block_13_project_BN'	Batch Normalization	Batch normalization with 160
122	'block_13_project_BN_anchorbox1'	Anchor Box Layer.	Anchor Box Layer.
123	'block_13_project_BN_mbox_conf_1'	Convolution	10 3x3 convolutions with s
124	'block_13_project_BN_mbox_loc_1'	Convolution	20 3x3 convolutions with s
125	'block_10_project_BN_anchorbox2'	Anchor Box Layer.	Anchor Box Layer.
126	'block_10_project_BN_mbox_conf_1'	Convolution	10 3x3 convolutions with s
127	'block_10_project_BN_mbox_loc_1'	Convolution	20 3x3 convolutions with s
128	'confmerge'	SSD Merge Layer.	SSD Merge Layer.
129	'locmerge'	SSD Merge Layer.	SSD Merge Layer.
130	'anchorBoxSoft'	Softmax	softmax
131	'focal_loss'	Focal Loss Layer.	Focal Loss Layer.
132	'rcnnboxRegression'	Box Regression Output	smooth-l1 loss

Configure the network training options.

```
options = trainingOptions('sgdm',...
    'InitialLearnRate',5e-5,...
    'MiniBatchSize',16,...
    'Verbose',true,...
    'MaxEpochs',50,...
    'Shuffle','every-epoch',...
    'VerboseFrequency',10,...
    'CheckpointPath',tempdir);
```

Train the SSD network.

```
[detector,info] = trainSSDObjectDetector(ds,lgraph,options);
```

```
*****
```

Training an SSD Object Detector for the following object classes:

```
* vehicle
```

Training on single CPU.

Initializing input data normalization.

Epoch	Iteration	Time Elapsed (hh:mm:ss)	Mini-batch Loss	Mini-batch Accuracy	Mini-batch RMSE	Base Lea Rate
1	1	00:00:18	0.8757	48.51%	1.47	5.00
1	10	00:01:43	0.8386	48.35%	1.43	5.00
2	20	00:03:15	0.7860	48.87%	1.37	5.00
2	30	00:04:42	0.6771	48.65%	1.23	5.00
3	40	00:06:46	0.7129	48.43%	1.28	5.00
3	50	00:08:37	0.5723	49.04%	1.09	5.00
4	60	00:10:12	0.5632	48.72%	1.08	5.00
4	70	00:11:25	0.5438	49.11%	1.06	5.00
5	80	00:12:35	0.5277	48.48%	1.03	5.00
5	90	00:13:39	0.4711	48.95%	0.96	5.00
6	100	00:14:50	0.5063	48.72%	1.00	5.00
7	110	00:16:11	0.4812	48.99%	0.97	5.00
7	120	00:17:27	0.5248	48.53%	1.04	5.00
8	130	00:18:33	0.4245	49.32%	0.90	5.00
8	140	00:19:37	0.4889	48.87%	0.98	5.00
9	150	00:20:47	0.4213	49.18%	0.89	5.00
9	160	00:22:02	0.4753	49.45%	0.97	5.00
10	170	00:23:13	0.4454	49.31%	0.92	5.00
10	180	00:24:22	0.4378	49.26%	0.92	5.00
11	190	00:25:29	0.4278	49.13%	0.90	5.00
12	200	00:26:39	0.4494	49.77%	0.93	5.00
12	210	00:27:45	0.4298	49.03%	0.90	5.00
13	220	00:28:47	0.4296	49.86%	0.90	5.00
13	230	00:30:05	0.3987	49.65%	0.86	5.00
14	240	00:31:13	0.4042	49.46%	0.87	5.00
14	250	00:32:20	0.4244	50.16%	0.90	5.00
15	260	00:33:31	0.4374	49.72%	0.93	5.00
15	270	00:34:38	0.4016	48.95%	0.86	5.00
16	280	00:35:47	0.4289	49.44%	0.91	5.00
17	290	00:36:58	0.3866	49.10%	0.84	5.00
17	300	00:38:10	0.4077	49.59%	0.87	5.00
18	310	00:39:24	0.3943	49.74%	0.86	5.00

18	320	00:40:48	0.4206	49.99%	0.89	5.00
19	330	00:41:53	0.4504	49.72%	0.94	5.00
19	340	00:42:55	0.3449	50.38%	0.78	5.00
20	350	00:44:01	0.3450	49.57%	0.77	5.00
20	360	00:44:59	0.3769	50.24%	0.83	5.00
21	370	00:46:05	0.3336	50.40%	0.76	5.00
22	380	00:47:01	0.3453	49.27%	0.78	5.00
22	390	00:48:04	0.4011	49.72%	0.87	5.00
23	400	00:49:06	0.3307	50.32%	0.75	5.00
23	410	00:50:03	0.3186	50.01%	0.73	5.00
24	420	00:51:10	0.3491	50.43%	0.78	5.00
24	430	00:52:17	0.3299	50.31%	0.76	5.00
25	440	00:53:35	0.3326	50.78%	0.76	5.00
25	450	00:54:42	0.3219	50.61%	0.75	5.00
26	460	00:55:55	0.3090	50.59%	0.71	5.00
27	470	00:57:08	0.3036	51.48%	0.71	5.00
27	480	00:58:16	0.3359	50.43%	0.76	5.00
28	490	00:59:24	0.3182	50.35%	0.73	5.00
28	500	01:00:36	0.3265	50.71%	0.76	5.00
29	510	01:01:44	0.3415	50.53%	0.78	5.00
29	520	01:02:51	0.3126	51.15%	0.73	5.00
30	530	01:03:59	0.3179	50.74%	0.75	5.00
30	540	01:05:15	0.3032	50.83%	0.72	5.00
31	550	01:06:25	0.2868	50.69%	0.68	5.00
32	560	01:07:42	0.2716	50.85%	0.66	5.00
32	570	01:08:53	0.3016	51.32%	0.71	5.00
33	580	01:10:05	0.2624	51.35%	0.63	5.00
33	590	01:11:12	0.3145	51.38%	0.73	5.00
34	600	01:12:31	0.2949	51.28%	0.70	5.00
34	610	01:13:46	0.3070	51.22%	0.73	5.00
35	620	01:15:01	0.3119	51.49%	0.73	5.00
35	630	01:16:14	0.2869	51.81%	0.70	5.00
36	640	01:17:28	0.3401	51.28%	0.78	5.00
37	650	01:18:40	0.3123	51.43%	0.73	5.00
37	660	01:19:58	0.2954	51.27%	0.71	5.00
38	670	01:21:12	0.2792	52.17%	0.68	5.00
38	680	01:22:29	0.3225	51.36%	0.76	5.00
39	690	01:23:41	0.2867	52.63%	0.69	5.00
39	700	01:24:56	0.3067	51.52%	0.73	5.00
40	710	01:26:13	0.2718	51.84%	0.66	5.00
40	720	01:27:25	0.2888	52.03%	0.70	5.00
41	730	01:28:42	0.2854	51.96%	0.69	5.00
42	740	01:29:57	0.2744	51.18%	0.67	5.00
42	750	01:31:10	0.2582	51.90%	0.64	5.00
43	760	01:32:25	0.2586	52.48%	0.64	5.00
43	770	01:33:35	0.2632	51.47%	0.65	5.00
44	780	01:34:46	0.2532	51.58%	0.63	5.00
44	790	01:36:07	0.2889	52.19%	0.69	5.00
45	800	01:37:20	0.2551	52.35%	0.63	5.00
45	810	01:38:27	0.2863	51.29%	0.69	5.00
46	820	01:39:43	0.2700	52.58%	0.67	5.00
47	830	01:40:54	0.3234	51.96%	0.76	5.00
47	840	01:42:08	0.2819	52.88%	0.69	5.00
48	850	01:43:23	0.2743	52.80%	0.67	5.00
48	860	01:44:38	0.2365	52.21%	0.60	5.00
49	870	01:45:58	0.2271	52.23%	0.58	5.00
49	880	01:47:21	0.3006	52.23%	0.72	5.00
50	890	01:48:35	0.2494	52.32%	0.63	5.00

```
| 50 | 900 | 01:49:55 | 0.2383 | 53.51% | 0.61 | 5.0
```

```
Detector training complete.
```

```
*****
```

Inspect the properties of the detector.

```
detector
```

```
detector =
  ssdObjectDetector with properties:

    ModelName: 'vehicle'
    Network: [1x1 DAGNetwork]
    ClassNames: {'vehicle' 'Background'}
    AnchorBoxes: {[5x2 double] [5x2 double]}
```

You can verify the training accuracy by inspecting the training loss for each iteration.

```
figure
plot(info.TrainingLoss)
grid on
xlabel('Number of Iterations')
ylabel('Training Loss for Each Iteration')
```

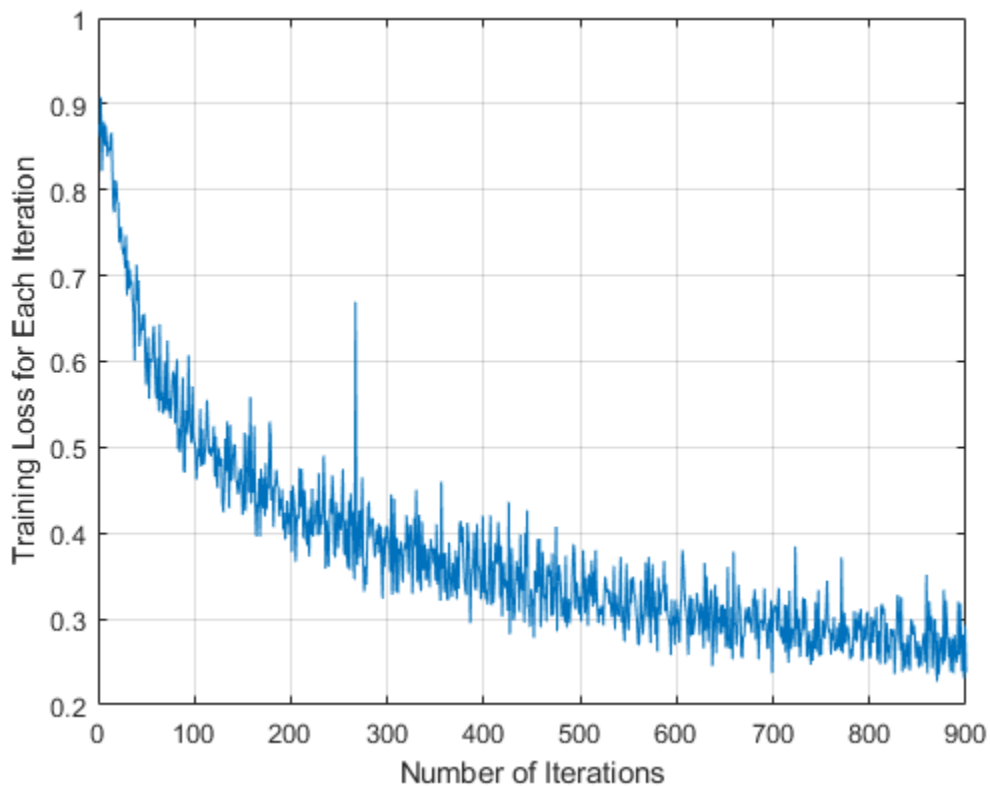

Test the SSD detector on a test image.

```
img = imread('ssdTestDetect.png');
```

Run the SSD object detector on the image for vehicle detection.

```
[bboxes,scores] = detect(detector,img);
```

Display the detection results.

```
if(~isempty(bboxes))  
    img = insertObjectAnnotation(img,'rectangle',bboxes,scores);  
end  
figure  
imshow(img)
```

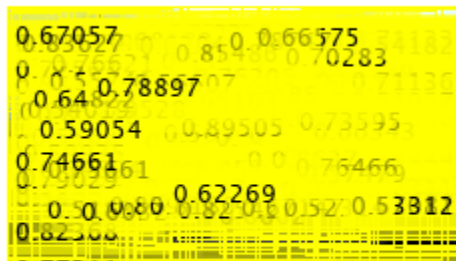

Input Arguments

trainingData — Labeled ground truth images

datastore

Labeled ground truth images, specified as a datastore or a table.

- If you use a datastore, your data must be set up so that calling the datastore with the `read` and `readall` functions returns a cell array or table with two or three columns. When the output contains two columns, the first column must contain bounding boxes, and the second column must contain labels, `{boxes,labels}`. When the output contains three columns, the second column must contain the bounding boxes, and the third column must contain the labels. In this case, the first column can contain any type of data. For example, the first column can contain images or point cloud data.

data	boxes	labels
The first column can contain data, such as point cloud data or images.	<p>The second column must be a cell array that contains M-by-5 matrices of bounding boxes of the form $[x_{center}, y_{center}, width, height, yaw]$. The vectors represent the location and size of bounding boxes for the objects in each image.</p> <p>If the bounding box is axis-aligned, then you do not need to specify the yaw. Therefore, the bounding box would be described as an M-by-4 matrices of bounding boxes of the form $[x_{center}, y_{center}, width, height]$.</p>	The third column must be a cell array that contains M -by-1 categorical vectors containing object class names. All categorical data returned by the datastore must contain the same categories.

For more information, see “Datastores for Deep Learning” (Deep Learning Toolbox).

lgraph — Layer graph

LayerGraph object

Layer graph, specified as a LayerGraph object. The layer graph contains the architecture of the SSD multibox network. You can create this network by using the `ssdLayers` function or create a custom network. For more information, see “Getting Started with SSD Multibox Detection”.

detector — Previously trained SSD object detector

ssdObjectDetector object

Previously trained SSD object detector, specified as a `ssdObjectDetector` object. Use this syntax to continue training a detector with additional training data or to perform more training iterations to improve detector accuracy.

options — Training options

TrainingOptionsSGDM object | TrainingOptionsRMSProp object | TrainingOptionsADAM object

Training options, specified as a TrainingOptionsSGDM, TrainingOptionsRMSProp, or TrainingOptionsADAM object returned by the `trainingOptions` function. To specify the solver name and other options for network training, use the `trainingOptions` function.

Note The `trainSSDObjectDetector` function does not support these training options:

- Datastore inputs are not supported when you set the `DispatchInBackground` training option to `true`.
-

checkpoint — Saved detector checkpoint

ssdObjectDetector object

Saved detector checkpoint, specified as an `ssdObjectDetector` object. To save the detector after every epoch, set the 'CheckpointPath' name-value argument when using the `trainingOptions` function. Saving a checkpoint after every epoch is recommended because network training can take a few hours.

To load a checkpoint for a previously trained detector, load the MAT-file from the checkpoint path. For example, if the `CheckpointPath` property of the object specified by `options` is '/checkpath', you can load a checkpoint MAT-file by using this code.

```
data = load('/checkpath/ssd_checkpoint_216_2018_11_16_13_34_30.mat');  
checkpoint = data.detector;
```

The name of the MAT-file includes the iteration number and timestamp of when the detector checkpoint was saved. The detector is saved in the `detector` variable of the file. Pass this file back into the `trainSSDObjectDetector` function:

```
ssdDetector = trainSSDObjectDetector(trainingData,checkpoint,options);
```

Name-Value Pair Arguments

Specify optional comma-separated pairs of `Name, Value` arguments. `Name` is the argument name and `Value` is the corresponding value. `Name` must appear inside quotes. You can specify several name and value pair arguments in any order as `Name1, Value1, ..., NameN, ValueN`.

Example: 'PositiveOverlapRange',[0.5 1] sets the vertical axis direction to up.

PositiveOverlapRange — Range of bounding box overlap ratios

[0.5 1] (default) | two-element vector

Range of bounding box overlap ratios between 0 and 1, specified as a two-element vector. Anchor boxes that overlap with ground truth bounding boxes within the specified range are used as positive training samples. The function computes the overlap ratio using the intersection-over-union between two bounding boxes.

NegativeOverlapRange — Range of bounding box overlap ratios

[0 0.5] (default) | two-element vector

Range of bounding box overlap ratios between 0 and 1, specified as a two-element vector. Anchor boxes that overlap with ground truth bounding boxes within the specified range are used as negative training samples. The function computes the overlap ratio using the intersection-over-union between two bounding boxes.

ExperimentManager — Detector training experiment monitoring

'none' (default) | `experiments.Monitor` object

Detector training experiment monitoring, specified as an `experiments.Monitor` object for use with the **Experiment Manager** app. You can use this object to track the progress of training, update information fields in the training results table, record values of the metrics used by the training, and to produce training plots.

Information monitored during training:

- Training loss at each iteration.
- Training accuracy at each iteration.

- Training root mean square error (RMSE) for the box regression layer.
- Learning rate at each iteration.

Validation information when the training `options` input contains validation data:

- Validation loss at each iteration.
- Validation accuracy at each iteration.
- Validation RMSE at each iteration.

Computed metrics when training ends:

- Final validation loss at the end of the training.
- Final validation RMSE at the end of the training.

Output Arguments

trainedDetector — Trained SSD multibox object detector

`ssdObjectDetector` object

Trained SSD object detector, returned as `ssdObjectDetector` object. You can train a SSD object detector to detect multiple object classes.

info — Training progress information

structure array

Training progress information, returned as a structure array with eight fields. Each field corresponds to a stage of training.

- **TrainingLoss** — Training loss at each iteration is the mean squared error (MSE) calculated as the sum of localization error, confidence loss, and classification loss. For more information about the training loss function, see "Training Loss" on page 3-1028.
- **TrainingAccuracy** — Training set accuracy at each iteration.
- **TrainingRMSE** — Training root mean squared error (RMSE) is the RMSE calculated from the training loss at each iteration.
- **BaseLearnRate** — Learning rate at each iteration.
- **ValidationLoss** — Validation loss at each iteration.
- **ValidationAccuracy** — Validation accuracy at each iteration.
- **ValidationRMSE** — Validation RMSE at each iteration.
- **FinalValidationLoss** — Final validation loss at end of the training.
- **FinalValidationRMSE** — Final validation RMSE at end of the training.

Each field is a numeric vector with one element per training iteration. Values that have not been calculated at a specific iteration are assigned as NaN. The struct contains **ValidationLoss**, **ValidationAccuracy**, **ValidationRMSE**, **FinalValidationLoss**, and **FinalValidationRMSE** fields only when `options` specifies validation data.

References

- [1] W. Liu, E. Anguelov, D. Erhan, C. Szegedy, S. Reed, C. Fu, and A.C. Berg. "SSD: Single Shot MultiBox Detector." *European Conference on Computer Vision (ECCV)*, Springer Verlag, 2016

See Also

Apps

Image Labeler | **Video Labeler**

Functions

ssdLayers | trainingOptions | objectDetectorTrainingData

Objects

ssdObjectDetector | boxLabelDatastore | anchorBoxLayer | focalLossLayer

Topics

“Object Detection Using SSD Deep Learning”

“Create SSD Object Detection Network”

“Estimate Anchor Boxes From Training Data”

“Code Generation for Object Detection by Using Single Shot Multibox Detector”

“Getting Started with SSD Multibox Detection”

“Anchor Boxes for Object Detection”

“Datastores for Deep Learning” (Deep Learning Toolbox)

Introduced in R2020a

trainFasterRCNNObjectDetector

Train a Faster R-CNN deep learning object detector

Syntax

```
trainedDetector = trainFasterRCNNObjectDetector(trainingData, network, options)
[trainedDetector, info] = trainFasterRCNNObjectDetector( ___ )
```

```
trainedDetector = trainFasterRCNNObjectDetector(trainingData, checkpoint,
options)
```

```
trainedDetector = trainFasterRCNNObjectDetector(trainingData, detector,
options)
```

```
trainedDetector = trainFasterRCNNObjectDetector( ___, Name, Value)
```

Description

Train a Detector

```
trainedDetector = trainFasterRCNNObjectDetector(trainingData, network, options)
```

trains a Faster R-CNN (regions with convolution neural networks) object detector using deep learning. You can train a Faster R-CNN detector to detect multiple object classes.

This function requires that you have Deep Learning Toolbox. It is recommended that you also have Parallel Computing Toolbox to use with a CUDA-enabled NVIDIA GPU. For information about the supported compute capabilities, see “GPU Support by Release” (Parallel Computing Toolbox).

[trainedDetector, info] = trainFasterRCNNObjectDetector(___) also returns information on the training progress, such as training loss and accuracy, for each iteration.

Resume Training a Detector

```
trainedDetector = trainFasterRCNNObjectDetector(trainingData, checkpoint,
options)
```

resumes training from a detector checkpoint.

Fine-Tune a Detector

```
trainedDetector = trainFasterRCNNObjectDetector(trainingData, detector,
options)
```

continues training a Faster R-CNN object detector with additional fine-tuning options. Use this syntax with additional training data or to perform more training iterations to improve detector accuracy.

Additional Properties

```
trainedDetector = trainFasterRCNNObjectDetector( ___, Name, Value)
```

uses additional options specified by one or more Name, Value pair arguments and any of the previous inputs.

Examples

Train Faster R-CNN Vehicle Detector

Load training data.

```
data = load('fasterRCNNVehicleTrainingData.mat');
trainingData = data.vehicleTrainingData;
trainingData.imageFilename = fullfile(toolboxdir('vision'),'visiondata', ...
    trainingData.imageFilename);
```

Randomly shuffle data for training.

```
rng(0);
shuffledIdx = randperm(height(trainingData));
trainingData = trainingData(shuffledIdx,:);
```

Create an image datastore using the files from the table.

```
imds = imageDatastore(trainingData.imageFilename);
```

Create a box label datastore using the label columns from the table.

```
blds = boxLabelDatastore(trainingData(:,2:end));
```

Combine the datastores.

```
ds = combine(imds, blds);
```

Set up the network layers.

```
lgraph = layerGraph(data.detector.Network);
```

Configure training options.

```
options = trainingOptions('sgdm', ...
    'MiniBatchSize', 1, ...
    'InitialLearnRate', 1e-3, ...
    'MaxEpochs', 7, ...
    'VerboseFrequency', 200, ...
    'CheckpointPath', tempdir);
```

Train detector. Training will take a few minutes. Adjust the `NegativeOverlapRange` and `PositiveOverlapRange` to ensure training samples tightly overlap with ground truth.

```
detector = trainFasterRCNNObjectDetector(ds, lgraph, options, ...
    'NegativeOverlapRange',[0 0.3], ...
    'PositiveOverlapRange',[0.6 1]);
```

```
*****
Training a Faster R-CNN Object Detector for the following object classes:
```

```
* vehicle
```

Training on single GPU.

Initializing input data normalization.

```
|=====|
| Epoch | Iteration | Time Elapsed | Mini-batch | Mini-batch | Mini-batch | RPN Min: |
|        |           | (hh:mm:ss)  | Loss       | Accuracy   | RMSE       | Accu     |
```

1	1	00:00:00	0.8771	97.30%	0.83
1	200	00:01:15	0.5324	100.00%	0.15
2	400	00:02:40	0.4732	100.00%	0.15
3	600	00:04:03	0.4776	97.14%	0.09
3	800	00:05:23	0.5269	97.44%	0.18
4	1000	00:06:44	0.9749	100.00%	
5	1200	00:08:07	1.1952	97.62%	0.13
5	1400	00:09:24	0.6577	100.00%	
6	1600	00:10:46	0.6951	100.00%	
7	1800	00:12:08	0.5341	96.08%	0.09
7	2000	00:13:26	0.3333	100.00%	0.12
7	2065	00:13:52	1.0564	100.00%	

Detector training complete.

Test the Faster R-CNN detector on a test image.

```
img = imread('highway.png');
```

Run the detector.

```
[bbox, score, label] = detect(detector,img);
```

Display detection results.

```
detectedImg = insertShape(img, 'Rectangle',bbox);
figure
imshow(detectedImg)
```

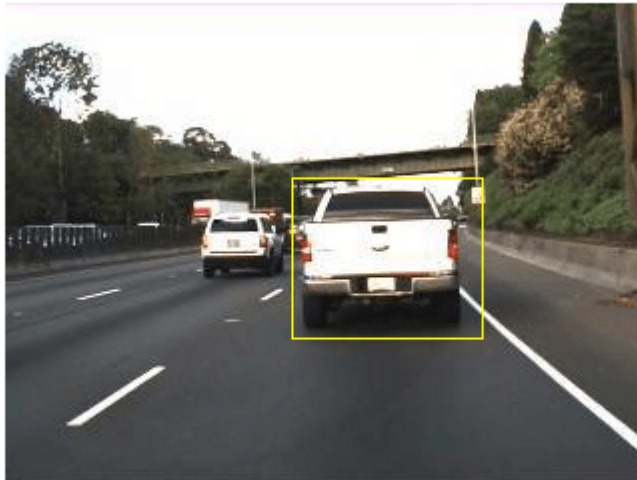

Input Arguments

trainingData — Labeled ground truth

datastore | table

Labeled ground truth, specified as a datastore or a table.

Each bounding box must be in the format $[x\ y\ width\ height]$.

- If you use a datastore, your data must be set up so that calling the datastore with the `read` and `readall` functions returns a cell array or table with two or three columns. When the output contains two columns, the first column must contain bounding boxes, and the second column must contain labels, $\{boxes, labels\}$. When the output contains three columns, the second column must contain the bounding boxes, and the third column must contain the labels. In this case, the first column can contain any type of data. For example, the first column can contain images or point cloud data.

data	boxes	labels
The first column can contain data, such as point cloud data or images.	<p>The second column must be a cell array that contains M-by-5 matrices of bounding boxes of the form $[x_{center}, y_{center}, width, height, yaw]$. The vectors represent the location and size of bounding boxes for the objects in each image.</p> <p>If the bounding box is axis-aligned, then you do not need to specify the yaw. Therefore, the bounding box would be described as an M-by-4 matrices of bounding boxes of the form $[x_{center}, y_{center}, width, height]$.</p>	The third column must be a cell array that contains M -by-1 categorical vectors containing object class names. All categorical data returned by the datastore must contain the same categories.

For more information, see “Datastores for Deep Learning” (Deep Learning Toolbox).

- If you use a table, the table must have two or more columns. The first column of the table must contain image file names with paths. The images must be grayscale or truecolor (RGB) and they can be in any format supported by `imread`. Each of the remaining columns must be a cell vector that contains M -by-4 matrices that represent a single object class, such as *vehicle*, *flower*, or *stop sign*. The columns contain 4-element double arrays of M bounding boxes in the format $[x,y,width,height]$. The format specifies the upper-left corner location and size of the bounding box in the corresponding image. To create a ground truth table, you can use the **Image Labeler** app or **Video Labeler** app. To create a table of training data from the generated ground truth, use the `objectDetectorTrainingData` function.

	1 imageFilename	2 stopSign
1	'stopSignImages/image005.jpg'	[980,393,31,56]
2	'stopSignImages/image006.jpg'	[1.0408e+03,354.7500,73,72]
3	'stopSignImages/image009.jpg'	[635,254,65,63]
4	'stopSignImages/image013.jpg'	[398.2050,261.2996,349.6806,385.6992]
5	'stopSignImages/image014.jpg'	[365.1880,306.3229,357.1845,421.7178]
6	'stopSignImages/image020.jpg'	[653.7500,307.7500,73.0000,76]
7	'stopSignImages/image021.jpg'	[589.7500,239.7500,181,196.0000]
8	'stopSignImages/image022.jpg'	[509.7500,470.7500,43,73]
9	'stopSignImages/image023.jpg'	[497.7500,49,90]

network — Network

SeriesNetwork object | array of Layer objects | LayerGraph object | network name

Network, specified as a `SeriesNetwork`, an array of `Layer` objects, a `LayerGraph` object, or by the network name. The network is trained to classify the object classes defined in the `trainingData` table. To use `SeriesNetwork`, `Layer`, and `layerGraph` objects, you must have Deep Learning Toolbox.

- When you specify the network as a `SeriesNetwork`, an array of `Layer` objects, or by the network name, the function transforms the network into a Faster R-CNN network by adding a region proposal network (RPN), an ROI max pooling layer, and new classification and regression layers to support object detection. Additionally, the `GridSize` property of the ROI max pooling layer is set to the output size of the last max pooling layer in the network.
- The array of `Layer` objects must contain a classification layer that supports the number of object classes, plus a background class. Use this input type to customize the learning rates of each layer. An example of an array of `Layer` objects follows:

```
layers = [imageInputLayer([28 28 3])
          convolution2dLayer([5 5],10)
          reluLayer()
          fullyConnectedLayer(10)
          softmaxLayer()
          classificationLayer()];
```

- When you specify the network as `SeriesNetwork` object, `Layer` array, or by the network name, the weights for additional convolution and fully connected layers are initialized to 'narrow-normal'. The function adds these weights to create the network.
- The network name must be one of the following valid network names. You must also install the corresponding add-on.

Network Name	Feature Extraction Layer Name	ROI Pooling Layer OutputSize	Description
alexnet	'relu5'	[6 6]	Last max pooling layer is replaced by ROI max pooling layer
vgg16	'relu5_3'	[7 7]	
vgg19	'relu5_4'		
squeezenet	'fire5-concat'	[14 14]	ROI pooling layer is inserted after the feature extraction layer.
resnet18	'res4b_relu'		
resnet50	'activation_40_relu'		
resnet101	'res4b22_relu'		
googlenet	'inception_4d-output'		
mobilenetv2	'block_13_expand_relu'		
inceptionv3	'mixed7'	[17 17]	
inceptionresnetv2	'block17_20_ac'		

- The LayerGraph object must be a valid Faster R-CNN object detection network. You can use the fasterRCNNLayers function to create a LayerGraph object to train a custom Faster R-CNN network.

Tip If your network is a DAGNetwork, use the layerGraph function to convert the network to a LayerGraph object. Then, create a custom Faster R-CNN network as described by the “Create Faster R-CNN Object Detection Network” example.

For more information on creating a Faster R-CNN network, see “Getting Started with R-CNN, Fast R-CNN, and Faster R-CNN”.

options — Training options

trainingOptions output

Training options, returned by the trainingOptions function (requires Deep Learning Toolbox). To specify solver and other options for network training, use trainingOptions.

Note trainFasterRCNNObjectDetector does not support these training options:

- Dastore inputs are not supported when you set the DispatchInBackground training option to true.

Additionally, the function does not support the following training options if you use a combined datastore input:

- 'once' and 'every-epoch' values for 'Shuffle' argument
 - 'parallel' and 'multi-gpu' values for 'ExecutionEnvironment' argument
-

checkpoint — Saved detector checkpoint

fasterRCNNObjectDetector object

Saved detector checkpoint, specified as a `fasterRCNNObjectDetector` object. To save the detector after every epoch, set the `'CheckpointPath'` property when using the `trainingOptions` function. Saving a checkpoint after every epoch is recommended because network training can take a few hours.

To load a checkpoint for a previously trained detector, load the MAT-file from the checkpoint path. For example, if the `'CheckpointPath'` property of `options` is `'/tmp'`, load a checkpoint MAT-file using:

```
data = load('/tmp/faster_rcnn_checkpoint__105__2016_11_18__14_25_08.mat');
```

The name of the MAT-file includes the iteration number and a timestamp indicating when the detector checkpoint was saved. The detector is saved in the `detector` variable of the file. Pass this file back into the `trainFasterRCNNObjectDetector` function:

```
frcnn = trainFasterRCNNObjectDetector(stopSigns,...
    data.detector,options);
```

detector — Previously trained Faster R-CNN object detector

fasterRCNNObjectDetector object

Previously trained Faster R-CNN object detector, specified as a `fasterRCNNObjectDetector` object. Use this syntax to continue training a detector with additional training data or to perform more training iterations to improve detector accuracy.

Name-Value Pair Arguments

Specify optional comma-separated pairs of `Name`, `Value` arguments. `Name` is the argument name and `Value` is the corresponding value. `Name` must appear inside quotes. You can specify several name and value pair arguments in any order as `Name1, Value1, ..., NameN, ValueN`.

Example: `'PositiveOverlapRange',[0.75 1]`

TrainingMethod — Training method

'end-to-end' (default) | 'four-step'

Training method, specified as the comma-separated pair consisting of `'TrainingMethod'` and either `'end-to-end'` or `'four-step'`.

- `'end-to-end'` — Simultaneously train the region proposal and region classification subnetworks.
- `'four-step'` — Separately train the region proposal and region classification subnetworks in four steps.

PositiveOverlapRange — Bounding box overlap ratios for positive training samples

[0.5 1] (default) | 2-by-2 matrix | 4-by-2 matrix

Bounding box overlap ratios for positive training samples, specified as the comma-separated pair consisting of `'PositiveOverlapRange'` and one of the following:

- A 2-element vector that specifies an identical overlap ratio for all four training stages.
- A 2-by-2 matrix, used only for the end-to-end training method. The first row of the matrix defines the overlap ratios for the region proposal subnetwork. The second row defines the overlap ratios for the region classification subnetwork.

- A 4-by-2 matrix, used only for the four-step training method. Each row of the matrix specifies the overlap ratio for each of the four training stages.

Values are in the range [0,1]. Region proposals that overlap with ground truth bounding boxes within the specified range are used as positive training samples.

The overlap ratio used for both the `PositiveOverlapRange` and `NegativeOverlapRange` is defined as:

$$\frac{\text{area}(A \cap B)}{\text{area}(A \cup B)}$$

A and B are bounding boxes.

NegativeOverlapRange — Bounding box overlap ratios for negative training samples

[0.1 0.5] (default) | 2-element vector | 4-by-2 matrix

Bounding box overlap ratios for negative training samples, specified as the comma-separated pair consisting of 'NegativeOverlapRange' and one of the following.

- A 2-element vector that specifies the overlap ratio.
- A 2-by-2 matrix, used only for the end-to-end training method. The first row of the matrix defines the overlap ratios for the region proposal subnetwork. The second row defines the overlap ratios for the region classification subnetwork.
- A 4-by-2 matrix, used only for the four-step training method. Each row of the matrix specifies the overlap ratio for each of the four training stages.

Values are in the range [0,1]. Region proposals that overlap with the ground truth bounding boxes within the specified range are used as negative training samples.

The overlap ratio used for both the `PositiveOverlapRange` and `NegativeOverlapRange` is defined as:

$$\frac{\text{area}(A \cap B)}{\text{area}(A \cup B)}$$

A and B are bounding boxes.

NumStrongestRegions — Maximum number of strongest region proposals

2000 (default) | positive integer | two-element vector

Maximum number of strongest region proposals to use for generating training samples, specified as the comma-separated pair consisting of 'NumStrongestRegions' and a positive integer. Reduce this value to speed up processing time at the cost of training accuracy. To use all region proposals, set this value to `Inf`.

NumRegionsToSample — Number of region proposals

128 (default) | integer | 1-by-2 vector | 1-by-4 vector

Number of region proposals to randomly sample from each training image, specified as an integer, 1-by-2 vector, or a 1-by-4 vector. Use the 1-by-2 vector for end-to-end training. Use the 1-by-4 vector for the four-step training. Reduce the number of regions to sample to reduce memory usage and speed up training. Reducing the value can also decrease training accuracy.

When you set 'TrainingMethod' to 'end-to-end', the number of region proposals can be set to a 1-by-2 vector. The first element of the vector must be the number of regions sampled for the region

proposal subnetwork. The second element must be the number of regions sampled for the region classification subnetwork.

When you set 'TrainingMethod' to 'four-step', the number of region proposals can be set to a 1-by-4 vector. The i^{th} element specifies the number of regions to sample for the i^{th} training step.

SmallestImageDimension — Length of smallest image dimension

[] (default) | positive integer

Length of the smallest image dimension, either width or height, specified as the comma-separated pair consisting of 'SmallestImageDimension' and a positive integer. Training images are resized such that the length of the shortest dimension is equal to the specified integer. By default, training images are not resized. Resizing training images helps reduce computational costs and memory used when training images are large. Typical values range from 400-600 pixels.

Dependencies

- The SmallestImageDimension property supports only table input training data. To resize the input data of a datastore input, use the `transform` function.

MinBoxSizes — Minimum anchor box sizes

'auto' (default) | m -by-2 matrix

Minimum anchor box sizes for building the anchor box pyramid of the region proposal network (RPN), specified as the comma-separated pair consisting of 'MinBoxSizes' and an m -by-2 matrix. Each row defines the [*height width*] of an anchor box.

The default 'auto' setting uses the minimum size and the median aspect ratio from the bounding boxes for each class in the ground truth data. To remove redundant box sizes, the function keeps boxes that have an intersection-over-union value that is less than or equal to 0.5. This behavior ensures that the minimum number of anchor boxes is used to cover all the object sizes and aspect ratios.

When anchor boxes are computed based on MinBoxSizes, the i^{th} anchor box size is:

```
round(MinBoxSizes(i,:) .* BoxPyramidScale , ^ (0:NumBoxPyramidLevels-1)')
```

Dependencies

- You cannot use this property if you specify the network as a LayerGraph object or if you resume training from a detector checkpoint.
- The MinBoxSizes property supports only input training in table format. To estimate anchor boxes for a datastore input, use the `estimateAnchorBoxes` function.

BoxPyramidScale — Anchor box pyramid scale

2 (default) | scalar

Anchor box pyramid scale factor used to successively upscale anchor box sizes, specified as the comma-separated pair consisting of 'BoxPyramidScale' and a scalar. Recommended values are from 1 through 2. Increase this value for faster results. Decrease the number for greater accuracy.

Dependencies

- The BoxPyramidScale property supports only input training data in table format. To estimate anchor boxes for a datastore input, use the `estimateAnchorBoxes` function.

NumBoxPyramidLevels — Number of anchor box pyramid levels`'auto'` (default) | scalar

Number of levels in an anchor box pyramid, specified as the comma-separated pair consisting of `'NumBoxPyramidLevels'` and a scalar. Select a value that ensures that the multiscale anchor boxes are comparable in size to the size of objects in the ground truth data.

The default setting `'auto'` selects the number of levels based on the size of objects within the ground truth data. The number of levels is selected such that it covers the range of object sizes.

Dependencies

- The `NumBoxPyramidLevels` property supports only input training data in table format. To estimate anchor boxes for a datastore input, use the `estimateAnchorBoxes` function.

FreezeBatchNormalization — Frozen batch normalization`true` (default) | `false`

Frozen batch normalization during training, specified as the comma-separated pair consisting of `'FreezeBatchNormalization'` and `true` or `false`. The value indicates whether to freeze the input layers to the network during training. Set this value to `true` if you are training with a small mini-batch size. Small batch sizes result in poor estimates of the batch mean and variance, which are required for effective batch normalization.

If you do not specify a value for `'FreezeBatchNormalization'`, the function sets the property to:

- `true` if the `'MiniBatchSize'` name-value argument for the `trainingOptions` function is less than 8.
- `false` if the `'MiniBatchSize'` name-value argument for the `trainingOptions` function is greater than or equal to 8.

You must specify a value for `'FreezeBatchNormalization'` to override this default behavior.

ExperimentManager — Detector training experiment monitoring`'none'` (default) | `experiments.Monitor` object

Detector training experiment monitoring, specified as an `experiments.Monitor` object for use with the **Experiment Manager** app. You can use this object to track the progress of training, update information fields in the training results table, record values of the metrics used by the training, and to produce training plots.

Information monitored during training:

- Training loss at each iteration.
- Training accuracy at each iteration.
- Training root mean square error (RMSE) for the box regression layer.
- Learning rate at each iteration.

Validation information when the `trainingOptions` input contains validation data:

- Validation loss at each iteration.
- Validation accuracy at each iteration.
- Validation RMSE at each iteration.

Computed metrics when training ends:

- Final validation loss at the end of the training.
- Final validation RMSE at the end of the training.

Output Arguments

trainedDetector — Trained Faster R-CNN object detector

`fasterRCNNObjectDetector` object

Trained Faster R-CNN object detector, returned as a `fasterRCNNObjectDetector` object.

info — Training progress information

structure array

Training progress information, returned as a structure array with eight fields. Each field corresponds to a stage of training.

- **TrainingLoss** — Training loss at each iteration is the mean squared error (MSE) calculated as the sum of localization error, confidence loss, and classification loss. For more information about the training loss function, see “Training Loss” on page 3-1028.
- **TrainingAccuracy** — Training set accuracy at each iteration.
- **TrainingRMSE** — Training root mean squared error (RMSE) is the RMSE calculated from the training loss at each iteration.
- **BaseLearnRate** — Learning rate at each iteration.
- **ValidationLoss** — Validation loss at each iteration.
- **ValidationAccuracy** — Validation accuracy at each iteration.
- **ValidationRMSE** — Validation RMSE at each iteration.
- **FinalValidationLoss** — Final validation loss at end of the training.
- **FinalValidationRMSE** — Final validation RMSE at end of the training.

Each field is a numeric vector with one element per training iteration. Values that have not been calculated at a specific iteration are assigned as NaN. The struct contains **ValidationLoss**, **ValidationAccuracy**, **ValidationRMSE**, **FinalValidationLoss**, and **FinalValidationRMSE** fields only when options specifies validation data.

Tips

- To accelerate data preprocessing for training, `trainFasterRCNNObjectDetector` automatically creates and uses a parallel pool based on your parallel preference settings. For more details about setting these preferences, see parallel preference settings. Using parallel computing preferences requires Parallel Computing Toolbox.
- VGG-16, VGG-19, ResNet-101, and Inception-ResNet-v2 are large models. Training with large images can produce "out-of-memory" errors. To mitigate these errors, try one or more of these options:
 - Reduce the size of your images by using the 'SmallestImageDimension' argument.
 - Decrease the value of the 'NumRegionsToSample' name-value argument.

- This function supports transfer learning. When you input a network by name, such as 'resnet50', then the function automatically transforms the network into a valid Faster R-CNN network model based on the pretrained resnet50 model. Alternatively, manually specify a custom Faster R-CNN network by using the LayerGraph extracted from a pretrained DAG network. For more details, see “Create Faster R-CNN Object Detection Network”.
- This table describes how to transform each named network into a Faster R-CNN network. The feature extraction layer name specifies the layer for processing by the ROI pooling layer. The ROI output size specifies the size of the feature maps output by the ROI pooling layer.

Network Name	Feature Extraction Layer Name	ROI Pooling Layer OutputSize	Description
alexnet	'relu5'	[6 6]	Last max pooling layer is replaced by ROI max pooling layer
vgg16	'relu5_3'	[7 7]	
vgg19	'relu5_4'		
squeezenet	'fire5-concat'	[14 14]	ROI pooling layer is inserted after the feature extraction layer.
resnet18	'res4b_relu'		
resnet50	'activation_40_relu'		
resnet101	'res4b22_relu'		
googlenet	'inception_4d-output'		
mobilenetv2	'block_13_expand_relu'		
inceptionv3	'mixed7'	[17 17]	
inceptionresnetv2	'block17_20_ac'		

For information on modifying how a network is transformed into a Faster R-CNN network, see “Design an R-CNN, Fast R-CNN, and a Faster R-CNN Model”.

- During training, multiple image regions are processed from the training images. The number of image regions per image is controlled by the NumRegionsToSample property. The PositiveOverlapRange and NegativeOverlapRange properties control which image regions are used for training. Positive training samples are those that overlap with the ground truth boxes by 0.6 to 1.0, as measured by the bounding box intersection-over-union metric (IoU). Negative training samples are those that overlap by 0 to 0.3. Choose values for these properties by testing the trained detector on a validation set.

Overlap Values	Description
PositiveOverlapRange set to [0.6 1]	Positive training samples are set equal to the samples that overlap with the ground truth boxes by 0.6 to 1.0, measured by the bounding box IoU metric.

Overlap Values	Description
NegativeOverlapRange set to [0 0.3]	Negative training samples are set equal to the samples that overlap with the ground truth boxes by 0 to 0.3.

If you set `PositiveOverlapRange` to [0.6 1], then the function sets the positive training samples equal to the samples that overlap with the ground truth boxes by 0.6 to 1.0, measured by the bounding box IoU metric. If you set `NegativeOverlapRange` to [0 0.3], then the function sets the negative training samples equal to the samples that overlap with the ground truth boxes by 0 to 0.3.

- Use the `trainingOptions` function to enable or disable verbose printing.

Compatibility Considerations

Default Training Method

Behavior changed in R2019b

Starting in R2019b, by default, the `trainFasterRCNNObjectDetector` function uses the end-to-end method for training a detector.

In previous releases, the default training method used the "four-step" method. To preserve compatibility, set the `TrainingMethod` property to 'four-step'.

References

- [1] Ren, S., K. He, R. Girschick, and J. Sun. "Faster R-CNN: Towards Real-Time Object Detection with Region Proposal Networks." *Advances in Neural Information Processing Systems*. Vol. 28, 2015.
- [2] Girshick, R. "Fast R-CNN." *Proceedings of the IEEE International Conference on Computer Vision*, 1440-1448. Santiago, Chile: IEEE, 2015.
- [3] Girshick, R., J. Donahue, T. Darrell, and J. Malik. "Rich Feature Hierarchies for Accurate Object Detection and Semantic Segmentation." *Proceedings of the 2014 IEEE Conference on Computer Vision and Pattern Recognition*, 580-587. Columbus, OH: IEEE, 2014.
- [4] Zitnick, C. L., and P. Dollar. "Edge Boxes: Locating Object Proposals from Edges." *Computer Vision-ECCV 2014*, 391-405. Zurich, Switzerland: ECCV, 2014.

Extended Capabilities

Automatic Parallel Support

Accelerate code by automatically running computation in parallel using Parallel Computing Toolbox™.

To run in parallel, set 'UseParallel' to `true` or enable this by default using the Computer Vision Toolbox preferences.

For more information, see "Parallel Computing Toolbox Support".

See Also

Apps

[Image Labeler](#) | [Video Labeler](#)

Functions

[trainRCNNObjectDetector](#) | [trainFastRCNNObjectDetector](#) | [trainingOptions](#) | [objectDetectorTrainingData](#) | [estimateAnchorBoxes](#) | [fasterRCNNLayers](#)

Objects

[maxPooling2dLayer](#) | [Layer](#) | [layerGraph](#) | [averagePooling2dLayer](#) | [SeriesNetwork](#) | [fasterRCNNObjectDetector](#) | [boxLabelDatastore](#)

Topics

[“Object Detection Using Faster R-CNN Deep Learning”](#)

[“Anchor Boxes for Object Detection”](#)

[“Getting Started with R-CNN, Fast R-CNN, and Faster R-CNN”](#)

[“Datastores for Deep Learning”](#) (Deep Learning Toolbox)

Introduced in R2017a

trainYOLOv2ObjectDetector

Train YOLO v2 object detector

Syntax

```
detector = trainYOLOv2ObjectDetector(trainingData,lgraph,options)
[detector,info] = trainYOLOv2ObjectDetector( ___ )

detector = trainYOLOv2ObjectDetector(trainingData,checkpoint,options)

detector = trainYOLOv2ObjectDetector(trainingData,detector,options)

detector = trainYOLOv2ObjectDetector( ___, 'TrainingImageSize', trainingSizes)

detector = trainYOLOv2ObjectDetector( ___, Name, Value)
```

Description

Train a Detector

`detector = trainYOLOv2ObjectDetector(trainingData,lgraph,options)` returns an object detector trained using you only look once version 2 (YOLO v2) network architecture specified by the input `lgraph`. The options input specifies training parameters for the detection network.

`[detector,info] = trainYOLOv2ObjectDetector(___)` also returns information on the training progress, such as the training accuracy and learning rate for each iteration.

Resume Training a Detector

`detector = trainYOLOv2ObjectDetector(trainingData,checkpoint,options)` resumes training from the saved detector checkpoint.

You can use this syntax to:

- Add more training data and continue the training.
- Improve training accuracy by increasing the maximum number of iterations.

Fine Tune a Detector

`detector = trainYOLOv2ObjectDetector(trainingData,detector,options)` continues training a YOLO v2 object detector. Use this syntax for fine-tuning a detector.

Multiscale Training

`detector = trainYOLOv2ObjectDetector(___, 'TrainingImageSize', trainingSizes)` specifies the image sizes for multiscale training by using a name-value pair in addition to the input arguments in any of the preceding syntaxes.

Additional Properties

`detector = trainYOLOv2ObjectDetector(___, Name, Value)` uses additional options specified by one or more `Name, Value` pair arguments and any of the previous inputs.

Examples

Train YOLO v2 Network for Vehicle Detection

Load the training data for vehicle detection into the workspace.

```
data = load('vehicleTrainingData.mat');
trainingData = data.vehicleTrainingData;
```

Specify the directory in which training samples are stored. Add full path to the file names in training data.

```
dataDir = fullfile(toolboxdir('vision'),'visiondata');
trainingData.imageFilename = fullfile(dataDir,trainingData.imageFilename);
```

Randomly shuffle data for training.

```
rng(0);
shuffledIdx = randperm(height(trainingData));
trainingData = trainingData(shuffledIdx,:);
```

Create an imageDatastore using the files from the table.

```
imds = imageDatastore(trainingData.imageFilename);
```

Create a boxLabelDatastore using the label columns from the table.

```
blds = boxLabelDatastore(trainingData(:,2:end));
```

Combine the datastores.

```
ds = combine(imds, blds);
```

Load a preinitialized YOLO v2 object detection network.

```
net = load('yolov2VehicleDetector.mat');
lgraph = net.lgraph
```

```
lgraph =
  LayerGraph with properties:
    Layers: [25x1 nnet.cnn.layer.Layer]
  Connections: [24x2 table]
  InputNames: {'input'}
  OutputNames: {'yolov2OutputLayer'}
```

Inspect the layers in the YOLO v2 network and their properties. You can also create the YOLO v2 network by following the steps given in “Create YOLO v2 Object Detection Network”.

```
lgraph.Layers
```

```
ans =
  25x1 Layer array with layers:
    1 'input'           Image Input           128x128x3 images
    2 'conv_1'         Convolution           16 3x3 convolutions with stride [1 1]
    3 'BN1'            Batch Normalization   Batch normalization
```

4	'relu_1'	ReLU	ReLU
5	'maxpool1'	Max Pooling	2x2 max pooling with stride [2 2] and
6	'conv_2'	Convolution	32 3x3 convolutions with stride [1 1]
7	'BN2'	Batch Normalization	Batch normalization
8	'relu_2'	ReLU	ReLU
9	'maxpool2'	Max Pooling	2x2 max pooling with stride [2 2] and
10	'conv_3'	Convolution	64 3x3 convolutions with stride [1 1]
11	'BN3'	Batch Normalization	Batch normalization
12	'relu_3'	ReLU	ReLU
13	'maxpool3'	Max Pooling	2x2 max pooling with stride [2 2] and
14	'conv_4'	Convolution	128 3x3 convolutions with stride [1 1]
15	'BN4'	Batch Normalization	Batch normalization
16	'relu_4'	ReLU	ReLU
17	'yolov2Conv1'	Convolution	128 3x3 convolutions with stride [1 1]
18	'yolov2Batch1'	Batch Normalization	Batch normalization
19	'yolov2Relu1'	ReLU	ReLU
20	'yolov2Conv2'	Convolution	128 3x3 convolutions with stride [1 1]
21	'yolov2Batch2'	Batch Normalization	Batch normalization
22	'yolov2Relu2'	ReLU	ReLU
23	'yolov2ClassConv'	Convolution	24 1x1 convolutions with stride [1 1]
24	'yolov2Transform'	YOLO v2 Transform Layer.	YOLO v2 Transform Layer with 4 anchors
25	'yolov2OutputLayer'	YOLO v2 Output	YOLO v2 Output with 4 anchors.

Configure the network training options.

```
options = trainingOptions('sgdm',...
    'InitialLearnRate',0.001,...
    'Verbose',true,...
    'MiniBatchSize',16,...
    'MaxEpochs',30,...
    'Shuffle','never',...
    'VerboseFrequency',30,...
    'CheckpointPath',tempdir);
```

Train the YOLO v2 network.

```
[detector,info] = trainYOLOv2ObjectDetector(ds,lgraph,options);
```

```
*****
```

Training a YOLO v2 Object Detector for the following object classes:

```
* vehicle
```

Training on single CPU.

Epoch	Iteration	Time Elapsed (hh:mm:ss)	Mini-batch RMSE	Mini-batch Loss	Base Learning Rate
1	1	00:00:01	7.13	50.8	0.0010
2	30	00:00:14	1.35	1.8	0.0010
4	60	00:00:27	1.13	1.3	0.0010
5	90	00:00:39	0.64	0.4	0.0010
7	120	00:00:51	0.65	0.4	0.0010
9	150	00:01:04	0.72	0.5	0.0010
10	180	00:01:16	0.52	0.3	0.0010
12	210	00:01:28	0.45	0.2	0.0010
14	240	00:01:41	0.61	0.4	0.0010
15	270	00:01:52	0.43	0.2	0.0010

17	300	00:02:05	0.42	0.2	0.0010
19	330	00:02:17	0.52	0.3	0.0010
20	360	00:02:29	0.43	0.2	0.0010
22	390	00:02:42	0.43	0.2	0.0010
24	420	00:02:54	0.59	0.4	0.0010
25	450	00:03:06	0.61	0.4	0.0010
27	480	00:03:18	0.65	0.4	0.0010
29	510	00:03:31	0.48	0.2	0.0010
30	540	00:03:42	0.34	0.1	0.0010

```
Detector training complete.
```

```
*****
```

Inspect the properties of the detector.

```
detector
```

```
detector =
  yolov2objectDetector with properties:
```

```
    ModelName: 'vehicle'
    Network: [1x1 DAGNetwork]
  TrainingImageSize: [128 128]
    AnchorBoxes: [4x2 double]
    ClassNames: vehicle
```

You can verify the training accuracy by inspecting the training loss for each iteration.

```
figure
plot(info.TrainingLoss)
grid on
xlabel('Number of Iterations')
ylabel('Training Loss for Each Iteration')
```

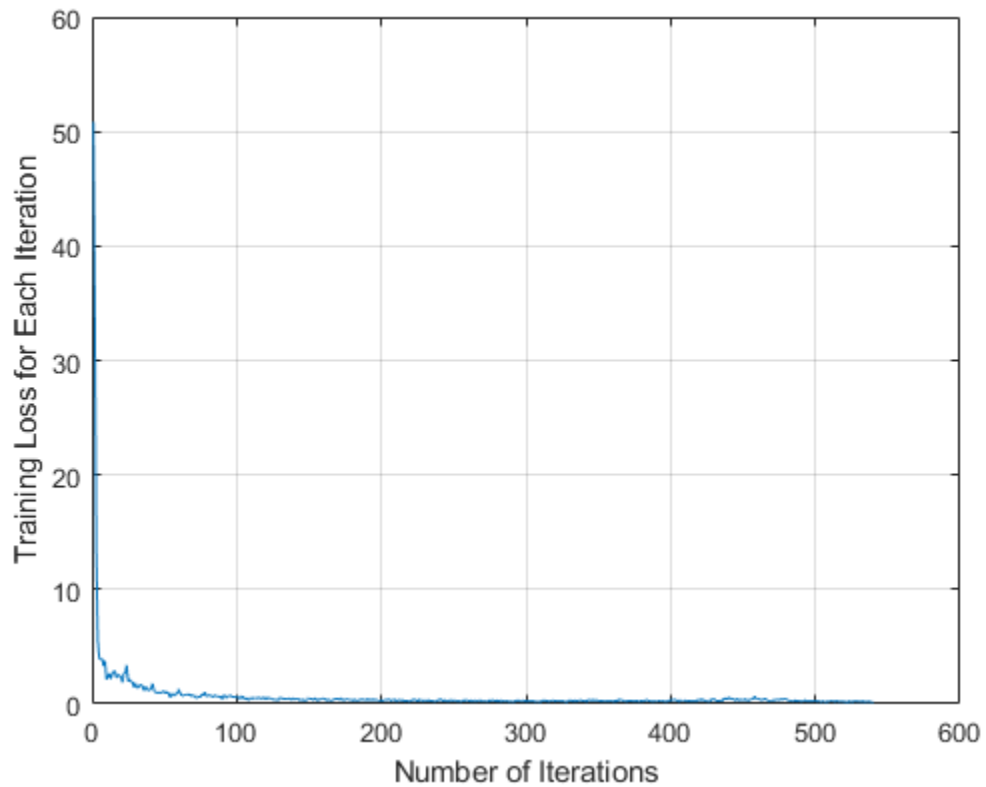

Read a test image into the workspace.

```
img = imread('detectcars.png');
```

Run the trained YOLO v2 object detector on the test image for vehicle detection.

```
[bboxes,scores] = detect(detector,img);
```

Display the detection results.

```
if(~isempty(bboxes))  
    img = insertObjectAnnotation(img,'rectangle',bboxes,scores);  
end  
figure  
imshow(img)
```

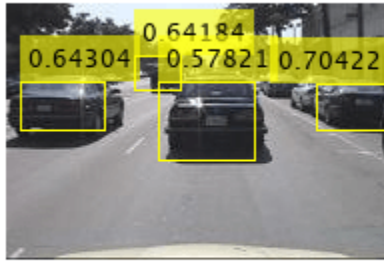

Input Arguments

trainingData — Labeled ground truth images

datastore | table

Labeled ground truth images, specified as a datastore or a table.

- If you use a datastore, your data must be set up so that calling the datastore with the `read` and `readall` functions returns a cell array or table with two or three columns. When the output contains two columns, the first column must contain bounding boxes, and the second column must contain labels, $\{boxes, labels\}$. When the output contains three columns, the second column must contain the bounding boxes, and the third column must contain the labels. In this case, the first column can contain any type of data. For example, the first column can contain images or point cloud data.

data	boxes	labels
The first column can contain data, such as point cloud data or images.	<p>The second column must be a cell array that contains M-by-5 matrices of bounding boxes of the form $[x_{center}, y_{center}, width, height, yaw]$. The vectors represent the location and size of bounding boxes for the objects in each image.</p> <p>If the bounding box is axis-aligned, then you do not need to specify the yaw. Therefore, the bounding box would be described as an M-by-4 matrices of bounding boxes of the form $[x_{center}, y_{center}, width, height]$.</p>	The third column must be a cell array that contains M -by-1 categorical vectors containing object class names. All categorical data returned by the datastore must contain the same categories.

For more information, see “Datastores for Deep Learning” (Deep Learning Toolbox).

- If you use a table, the table must have two or more columns. The first column of the table must contain image file names with paths. The images must be grayscale or truecolor (RGB) and they can be in any format supported by `imread`. Each of the remaining columns must be a cell vector that contains M -by-4 matrices that represent a single object class, such as *vehicle*, *flower*, or *stop sign*. The columns contain 4-element double arrays of M bounding boxes in the format `[x,y,width,height]`. The format specifies the upper-left corner location and size of the bounding box in the corresponding image. To create a ground truth table, you can use the **Image Labeler** app or **Video Labeler** app. To create a table of training data from the generated ground truth, use the `objectDetectorTrainingData` function.

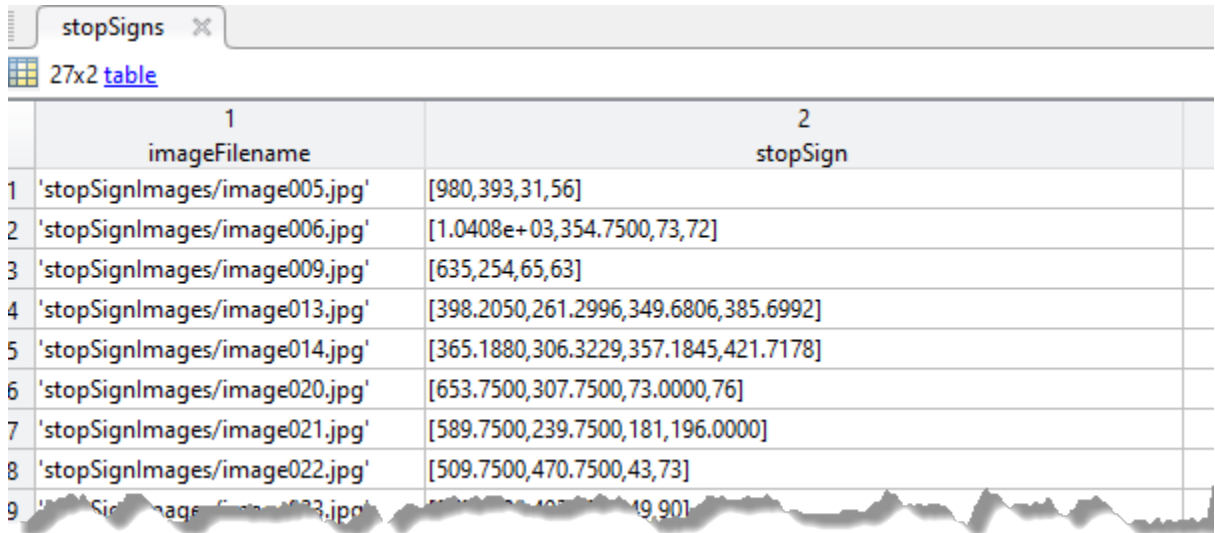

	1 imageFilename	2 stopSign
1	'stopSignImages/image005.jpg'	[980,393,31,56]
2	'stopSignImages/image006.jpg'	[1.0408e+03,354.7500,73,72]
3	'stopSignImages/image009.jpg'	[635,254,65,63]
4	'stopSignImages/image013.jpg'	[398.2050,261.2996,349.6806,385.6992]
5	'stopSignImages/image014.jpg'	[365.1880,306.3229,357.1845,421.7178]
6	'stopSignImages/image020.jpg'	[653.7500,307.7500,73.0000,76]
7	'stopSignImages/image021.jpg'	[589.7500,239.7500,181,196.0000]
8	'stopSignImages/image022.jpg'	[509.7500,470.7500,43,73]
9	'stopSignImages/image023.jpg'	[107.7500,19,90]

Note When the training data is specified using a table, the `trainYOLOv2ObjectDetector` function checks these conditions

- The bounding box values must be integers. Otherwise, the function automatically rounds each noninteger values to its nearest integer.
- The bounding box must not be empty and must be within the image region. While training the network, the function ignores empty bounding boxes and bounding boxes that lie partially or fully outside the image region.

lgraph — Layer graph

LayerGraph object

Layer graph, specified as a LayerGraph object. The layer graph contains the architecture of the YOLO v2 network. You can create this network by using the `yoLov2Layers` function. Alternatively, you can create the network layers by using `yoLov2TransformLayer`, `yoLov2ReorgLayer`, and `yoLov2OutputLayer` functions. For more details on creating a custom YOLO v2 network, see “Design a YOLO v2 Detection Network”.

options — Training options

TrainingOptionsSGDM object | TrainingOptionsRMSProp object | TrainingOptionsADAM object

Training options, specified as a `TrainingOptionsSGDM`, `TrainingOptionsRMSProp`, or `TrainingOptionsADAM` object returned by the `trainingOptions` function. To specify the solver name and other options for network training, use the `trainingOptions` function.

Note The `trainYOLOv2objectDetector` function does not support these training options:

- The `trainingOptions` `Shuffle` values, 'once' and 'every-epoch' are not supported when you use a datastore input.
 - Datastore inputs are not supported when you set the `DispatchInBackground` training option to `true`.
-

checkpoint — Saved detector checkpoint

`yolov2objectDetector` object

Saved detector checkpoint, specified as a `yolov2objectDetector` object. To save the detector after every epoch, set the 'CheckpointPath' name-value argument when using the `trainingOptions` function. Saving a checkpoint after every epoch is recommended because network training can take a few hours.

To load a checkpoint for a previously trained detector, load the MAT-file from the checkpoint path. For example, if the `CheckpointPath` property of the object specified by options is '/checkpoint', you can load a checkpoint MAT-file by using this code.

```
data = load('/checkpoint/yolov2_checkpoint__216__2018_11_16__13_34_30.mat');  
checkpoint = data.detector;
```

The name of the MAT-file includes the iteration number and timestamp of when the detector checkpoint was saved. The detector is saved in the `detector` variable of the file. Pass this file back into the `trainYOLOv2objectDetector` function:

```
yoloDetector = trainYOLOv2objectDetector(trainingData,checkpoint,options);
```

detector — Previously trained YOLO v2 object detector

`yolov2objectDetector` object

Previously trained YOLO v2 object detector, specified as a `yolov2objectDetector` object. Use this syntax to continue training a detector with additional training data or to perform more training iterations to improve detector accuracy.

trainingSizes — Set of image sizes for multiscale training

[] (default) | *M*-by-2 matrix

Set of image sizes for multiscale training, specified as an *M*-by-2 matrix, where each row is of the form [height width]. For each training epoch, the input training images are randomly resized to one of the *M* image sizes specified in this set.

If you do not specify the `trainingSizes`, the function sets this value to the size in the image input layer of the YOLO v2 network. The network resizes all training images to this value.

Note The input `trainingSizes` values specified for multiscale training must be greater than or equal to the input size in the image input layer of the `lgraph` input argument.

Name-Value Pair Arguments

Specify optional comma-separated pairs of `Name`, `Value` arguments. `Name` is the argument name and `Value` is the corresponding value. `Name` must appear inside quotes. You can specify several name and value pair arguments in any order as `Name1, Value1, . . . , NameN, ValueN`.

Example: `'ExperimentManager', 'none'` sets the `'ExperimentManager'` to `'none'`.

ExperimentManager — Detector training experiment monitoring

`'none'` (default) | `experiments.Monitor` object

Detector training experiment monitoring, specified as an `experiments.Monitor` object for use with the **Experiment Manager** app. You can use this object to track the progress of training, update information fields in the training results table, record values of the metrics used by the training, and to produce training plots.

Information monitored during training:

- Training loss at each iteration.
- Training accuracy at each iteration.
- Training root mean square error (RMSE) for the box regression layer.
- Learning rate at each iteration.

Validation information when the training `options` input contains validation data:

- Validation loss at each iteration.
- Validation accuracy at each iteration.
- Validation RMSE at each iteration.

Computed metrics when training ends:

- Final validation loss at the end of the training.
- Final validation RMSE at the end of the training.

Output Arguments

detector — Trained YOLO v2 object detector

`yolov2ObjectDetector` object

Trained YOLO v2 object detector, returned as `yolov2ObjectDetector` object. You can train a YOLO v2 object detector to detect multiple object classes.

info — Training progress information

structure array

Training progress information, returned as a structure array with seven fields. Each field corresponds to a stage of training.

- `TrainingLoss` — Training loss at each iteration is the mean squared error (MSE) calculated as the sum of localization error, confidence loss, and classification loss. For more information about the training loss function, see “Training Loss” on page 3-1028.
- `TrainingRMSE` — Training root mean squared error (RMSE) is the RMSE calculated from the training loss at each iteration.

- `BaseLearnRate` — Learning rate at each iteration.
- `ValidationLoss` — Validation loss at each iteration.
- `ValidationRMSE` — Validation RMSE at each iteration.
- `FinalValidationLoss` — Final validation loss at end of the training.
- `FinalValidationRMSE` — Final validation RMSE at end of the training.

Each field is a numeric vector with one element per training iteration. Values that have not been calculated at a specific iteration are assigned as `NaN`. The struct contains `ValidationLoss`, `ValidationAccuracy`, `ValidationRMSE`, `FinalValidationLoss`, and `FinalValidationRMSE` fields only when options specifies validation data.

More About

Data Preprocessing

By default, the `trainYOLOv2ObjectDetector` function preprocesses the training images by:

- Resizing the input images to match the input size of the network.
- Normalizing the pixel values of the input images to lie in the range `[0, 1]`.

When you specify the training data by using a table, the `trainYOLOv2ObjectDetector` function performs data augmentation for preprocessing. The function augments the input dataset by:

- Reflecting the training data horizontally. The probability for horizontally flipping each image in the training data is 0.5.
- Uniformly scaling (zooming) the training data by a scale factor that is randomly picked from a continuous uniform distribution in the range `[1, 1.1]`.
- Random color jittering for brightness, hue, saturation, and contrast.

When you specify the training data by using a datastore, the `trainYOLOv2ObjectDetector` function does not perform data augmentation. Instead you can augment the training data in datastore by using the `transform` function and then, train the network with the augmented training data. For more information on how to apply augmentation while using datastores, see “Preprocess Deep Learning Data” (Deep Learning Toolbox).

Training Loss

During training, the YOLO v2 object detection network optimizes the MSE loss between the predicted bounding boxes and the ground truth. The loss function is defined as

$$\begin{aligned}
& K_1 \sum_{i=0}^{S^2} \sum_{j=0}^B 1_{ij}^{obj} [(x_i - \widehat{x}_i)^2 + (y_i - \widehat{y}_i)^2] \\
& + K_1 \sum_{i=0}^{S^2} \sum_{j=0}^B 1_{ij}^{obj} [(\sqrt{w_i} - \sqrt{\widehat{w}_i})^2 + (\sqrt{h_i} - \sqrt{\widehat{h}_i})^2] \\
& + K_2 \sum_{i=0}^{S^2} \sum_{j=0}^B 1_{ij}^{obj} (C_i - \widehat{C}_i)^2 \\
& + K_3 \sum_{i=0}^{S^2} \sum_{j=0}^B 1_{ij}^{noobj} (C_i - \widehat{C}_i)^2 \\
& + K_4 \sum_{i=0}^{S^2} 1_i^{obj} \sum_{c \in classes} (p_i(c) - \widehat{p}_i(c))^2
\end{aligned}$$

where:

- S is the number of grid cells.
- B is the number of bounding boxes in each grid cell.
- 1_{ij}^{obj} is 1 if the j th bounding box in grid cell i is responsible for detecting the object. Otherwise it is set to 0. A grid cell i is responsible for detecting the object, if the overlap between the ground truth and a bounding box in that grid cell is greater than or equal to 0.6.
- 1_{ij}^{noobj} is 1 if the j th bounding box in grid cell i does not contain any object. Otherwise it is set to 0.
- 1_i^{obj} is 1 if an object is detected in grid cell i . Otherwise it is set to 0.
- $K_1, K_2, K_3,$ and K_4 are the weights. To adjust the weights, modify the `LossFactors` property of the output layer by using the `yolov2OutputLayer` function.

The loss function can be split into three parts:

- Localization loss

The first and second terms in the loss function comprise the localization loss. It measures error between the predicted bounding box and the ground truth. The parameters for computing the localization loss include the position, size of the predicted bounding box, and the ground truth. The parameters are defined as follows.

- (x_i, y_i) , is the center of the j th bounding box relative to grid cell i .
- $(\widehat{x}_i, \widehat{y}_i)$, is the center of the ground truth relative to grid cell i .
- w_i and h_i is the width and the height of the j th bounding box in grid cell i , respectively. The size of the predicted bounding box is specified relative to the input image size.
- \widehat{w}_i and \widehat{h}_i is the width and the height of the ground truth in grid cell i , respectively.
- K_1 is the weight for localization loss. Increase this value to increase the weightage for bounding box prediction errors.
- Confidence loss

The third and fourth terms in the loss function comprise the confidence loss. The third term measures the objectness (confidence score) error when an object is detected in the j th bounding

box of grid cell i . The fourth term measures the objectness error when no object is detected in the j th bounding box of grid cell i . The parameters for computing the confidence loss are defined as follows.

- C_i is the confidence score of the j th bounding box in grid cell i .
- \hat{C}_i is the confidence score of the ground truth in grid cell i .
- K_2 is the weight for objectness error, when an object is detected in the predicted bounding box. You can adjust the value of K_2 to weigh confidence scores from grid cells that contain objects.
- K_3 is the weight for objectness error, when an object is not detected in the predicted bounding box. You can adjust the value of K_3 to weigh confidence scores from grid cells that do not contain objects.

The confidence loss can cause the training to diverge when the number of grid cells that do not contain objects is more than the number of grid cells that contain objects. To remedy this, increase the value for K_2 and decrease the value for K_3 .

- Classification loss

The fifth term in the loss function comprises the classification loss. For example, suppose that an object is detected in the predicted bounding box contained in grid cell i . Then, the classification loss measures the squared error between the class conditional probabilities for each class in grid cell i . The parameters for computing the classification loss are defined as follows.

- $p_i(c)$ is the estimated conditional class probability for object class c in grid cell i .
- $\hat{p}_i(c)$ is the actual conditional class probability for object class c in grid cell i .
- K_4 is the weight for classification error when an object is detected in the grid cell. Increase this value to increase the weightage for classification loss.

Tips

- To generate the ground truth, use the **Image Labeler** or **Video Labeler** app. To create a table of training data from the generated ground truth, use the `objectDetectorTrainingData` function.
- To improve prediction accuracy,
 - Increase the number of images you can use to train the network. You can expand the training dataset through data augmentation. For information on how to apply data augmentation for preprocessing, see “Preprocess Images for Deep Learning” (Deep Learning Toolbox).
 - Perform multiscale training by using the `trainYOLOv2ObjectDetector` function. To do so, specify the 'TrainingImageSize' argument of `trainYOLOv2ObjectDetector` function for training the network.
 - Choose anchor boxes appropriate to the dataset for training the network. You can use the `estimateAnchorBoxes` function to compute anchor boxes directly from the training data.

References

- [1] Joseph. R, S. K. Divvala, R. B. Girshick, and F. Ali. "You Only Look Once: Unified, Real-Time Object Detection." In *Proceedings of the IEEE Conference on Computer Vision and Pattern Recognition (CVPR)*, pp. 779–788. Las Vegas, NV: CVPR, 2016.

[2] Joseph. R and F. Ali. "YOLO 9000: Better, Faster, Stronger." In *Proceedings of the IEEE Conference on Computer Vision and Pattern Recognition (CVPR)*, pp. 6517–6525. Honolulu, HI: CVPR, 2017.

See Also

Apps

[Image Labeler](#) | [Video Labeler](#)

Functions

[trainingOptions](#) | [trainRCNNObjectDetector](#) | [trainFastRCNNObjectDetector](#) | [trainFasterRCNNObjectDetector](#) | [objectDetectorTrainingData](#) | [yolov2Layers](#)

Objects

[yolov2ObjectDetector](#) | [boxLabelDatastore](#)

Topics

["Create YOLO v2 Object Detection Network"](#)
["Object Detection Using YOLO v2 Deep Learning"](#)
["Estimate Anchor Boxes From Training Data"](#)
["Code Generation for Object Detection by Using YOLO v2"](#)
["Getting Started with YOLO v2"](#)
["Anchor Boxes for Object Detection"](#)
["Datastores for Deep Learning" \(Deep Learning Toolbox\)](#)

Introduced in R2019a

detect

Detect objects using ACF object detector

Syntax

```
bboxes = detect(detector,I)
[bboxes,scores] = detect(detector,I)
[ ___ ]= detect(detector,I,roi)
[ ___ ] = detect( ___ ,Name,Value)
```

Description

`bboxes = detect(detector,I)` detects objects within image `I` using the input aggregate channel features (ACF) object detector. The locations of objects detected are returned as a set of bounding boxes.

`[bboxes,scores] = detect(detector,I)` also returns the detection scores for each bounding box.

`[___]= detect(detector,I,roi)` detects objects within the rectangular search region specified by `roi`, using either of the preceding syntaxes.

`[___] = detect(___ ,Name,Value)` specifies options using one or more `Name,Value` pair arguments. For example, `detect(detector,I,'WindowStride',2)` sets the stride of the sliding window used to detects objects to 2.

Examples

Train Stop Sign Detector Using ACF Object Detector

Use the `trainACFObjectDetector` with training images to create an ACF object detector that can detect stop signs. Test the detector with a separate image.

Load the training data.

```
load('stopSignsAndCars.mat')
```

Select the ground truth for stop signs. These ground truth is the set of known locations of stop signs in the images.

```
stopSigns = stopSignsAndCars(:,1:2);
```

Add the full path to the image files.

```
stopSigns.imageFilename = fullfile(toolboxdir('vision'),...
    'visiondata',stopSigns.imageFilename);
```

Train the ACF detector. You can turn off the training progress output by specifying `'Verbose',false` as a `Name,Value` pair.

```

acfDetector = trainACFObjectDetector(stopSigns, 'NegativeSamplesFactor', 2);

ACF Object Detector Training
The training will take 4 stages. The model size is 34x31.
Sample positive examples(~100% Completed)
Compute approximation coefficients...Completed.
Compute aggregated channel features...Completed.
-----
Stage 1:
Sample negative examples(~100% Completed)
Compute aggregated channel features...Completed.
Train classifier with 42 positive examples and 84 negative examples...Completed.
The trained classifier has 19 weak learners.
-----
Stage 2:
Sample negative examples(~100% Completed)
Found 84 new negative examples for training.
Compute aggregated channel features...Completed.
Train classifier with 42 positive examples and 84 negative examples...Completed.
The trained classifier has 20 weak learners.
-----
Stage 3:
Sample negative examples(~100% Completed)
Found 84 new negative examples for training.
Compute aggregated channel features...Completed.
Train classifier with 42 positive examples and 84 negative examples...Completed.
The trained classifier has 54 weak learners.
-----
Stage 4:
Sample negative examples(~100% Completed)
Found 84 new negative examples for training.
Compute aggregated channel features...Completed.
Train classifier with 42 positive examples and 84 negative examples...Completed.
The trained classifier has 61 weak learners.
-----
ACF object detector training is completed. Elapsed time is 20.1934 seconds.

Test the ACF detector on a test image.

img = imread('stopSignTest.jpg');

[bboxes,scores] = detect(acfDetector,img);

Display the detection results and insert the bounding boxes for objects into the image.

for i = 1:length(scores)
    annotation = sprintf('Confidence = %.1f',scores(i));
    img = insertObjectAnnotation(img,'rectangle',bboxes(i,:),annotation);
end

figure
imshow(img)

```



Input Arguments

detector — ACF object detector

`acfObjectDetector` object

ACF object detector, specified as an `acfObjectDetector` object. To create this object, call the `trainACFObjectDetector` function with training data as input.

I — Input image

grayscale image | RGB image

Input image, specified as a real, nonsparse, grayscale or RGB image.

Data Types: `uint8` | `uint16` | `int16` | `double` | `single` | `logical`

roi — Search region of interest

`[x y width height]` vector

Search region of interest, specified as an `[x y width height]` vector. The vector specifies the upper left corner and size of a region in pixels.

Name-Value Pair Arguments

Specify optional comma-separated pairs of `Name`, `Value` arguments. `Name` is the argument name and `Value` is the corresponding value. `Name` must appear inside quotes. You can specify several name and value pair arguments in any order as `Name1, Value1, ..., NameN, ValueN`.

Example: `'NumScaleLevels', 4`

NumScaleLevels — Number of scale levels per octave

8 (default) | positive integer

Number of scale levels per octave, specified as the comma-separated pair consisting of 'NumScaleLevels' and a positive integer. Each octave is a power-of-two downscaling of the image. To detect people at finer scale increments, increase this number. Recommended values are in the range [4, 8].

WindowStride — Stride for sliding window

4 (default) | positive integer

Stride for the sliding window, specified as the comma-separated pair consisting of 'WindowStride' and a positive integer. This value indicates the distance for the function to move the window in both the x and y directions. The sliding window scans the images for object detection.

SelectStrongest — Select strongest bounding box for each object

true (default) | false

Select the strongest bounding box for each detected object, specified as the comma-separated pair consisting of 'SelectStrongest' and either true or false.

- `true` — Return the strongest bounding box per object. To select these boxes, `detect` calls the `selectStrongestBbox` function, which uses nonmaximal suppression to eliminate overlapping bounding boxes based on their confidence scores.
- `false` — Return all detected bounding boxes. You can then create your own custom operation to eliminate overlapping bounding boxes.

MinSize — Minimum region size*[height width]* vector

Minimum region size that contains a detected object, specified as the comma-separated pair consisting of 'MinSize' and a *[height width]* vector. Units are in pixels.

By default, MinSize is the smallest object that the trained `detector` can detect.

MaxSize — Maximum region sizesize(I) (default) | *[height width]* vector

Maximum region size that contains a detected object, specified as the comma-separated pair consisting of 'MaxSize' and a *[height width]* vector. Units are in pixels.

To reduce computation time, set this value to the known maximum region size for the objects being detected in the image. By default, 'MaxSize' is set to the height and width of the input image, `I`.

Threshold — Classification accuracy threshold

-1 (default) | numeric scalar

Classification accuracy threshold, specified as the comma-separated pair consisting of 'Threshold' and a numeric scalar. Recommended values are in the range [-1, 1]. During multiscale object detection, the threshold value controls the accuracy and speed for classifying image subregions as either objects or nonobjects. To speed up the performance at the risk of missing true detections, increase this threshold.

Output Arguments

bboxes — Location of objects detected within image

M-by-4 matrix

Location of objects detected within the input image, returned as an *M*-by-4 matrix, where *M* is the number of bounding boxes. Each row of `bboxes` contains a four-element vector of the form [*x* *y* *width* *height*]. This vector specifies the upper left corner and size of that corresponding bounding box in pixels.

scores — Detection confidence scores

M-by-1 vector

Detection confidence scores, returned as an *M*-by-1 vector, where *M* is the number of bounding boxes. A higher score indicates higher confidence in the detection.

Extended Capabilities

C/C++ Code Generation

Generate C and C++ code using MATLAB® Coder™.

Usage notes and limitations:

- To generate code, use `toStruct` function to pass the `acfObjectDetector` object to the `detect` function. For more information, see “Generate Code for Detecting Objects in Images by Using ACF Object Detector”.

See Also

Apps

[Image Labeler](#) | [Video Labeler](#)

Functions

[trainACFObjectDetector](#) | [detectPeopleACF](#) | [trainCascadeObjectDetector](#) | [selectStrongestBbox](#)

Objects

[acfObjectDetector](#)

Introduced in R2017a

detect

Detect objects using R-CNN deep learning detector

Syntax

```
bboxes = detect(detector,I)
[bboxes,scores] = detect(detector,I)
[ ___,labels] = detect(detector,I)
[ ___ ] = detect( ___,roi)
[ ___ ] = detect( ___,Name,Value)
```

Description

`bboxes = detect(detector,I)` detects objects within image `I` using an R-CNN (regions with convolutional neural networks) object detector. The locations of objects detected are returned as a set of bounding boxes.

When using this function, use of a CUDA enabled NVIDIA GPU is highly recommended. The GPU reduces computation time significantly. Usage of the GPU requires Parallel Computing Toolbox. For information about the supported compute capabilities, see “GPU Support by Release” (Parallel Computing Toolbox).

`[bboxes,scores] = detect(detector,I)` also returns the detection scores for each bounding box.

`[___,labels] = detect(detector,I)` also returns a categorical array of labels assigned to the bounding boxes, using either of the preceding syntaxes. The labels used for object classes are defined during training using the `trainRCNNObjectDetector` function.

`[___] = detect(___,roi)` detects objects within the rectangular search region specified by `roi`.

`[___] = detect(___,Name,Value)` specifies options using one or more `Name,Value` pair arguments. For example, `detect(detector,I,'NumStrongestRegions',1000)` limits the number of strongest region proposals to 1000.

Examples

Train R-CNN Stop Sign Detector

Load training data and network layers.

```
load('rcnnStopSigns.mat','stopSigns','layers')
```

Add the image directory to the MATLAB path.

```
imDir = fullfile(matlabroot,'toolbox','vision','visiondata',...
    'stopSignImages');
addpath(imDir);
```

Set network training options to use mini-batch size of 32 to reduce GPU memory usage. Lower the InitialLearningRate to reduce the rate at which network parameters are changed. This is beneficial when fine-tuning a pre-trained network and prevents the network from changing too rapidly.

```
options = trainingOptions('sgdm', ...
    'MiniBatchSize', 32, ...
    'InitialLearnRate', 1e-6, ...
    'MaxEpochs', 10);
```

Train the R-CNN detector. Training can take a few minutes to complete.

```
rcnn = trainRCNNObjectDetector(stopSigns, layers, options, 'NegativeOverlapRange', [0 0.3]);
```

```
*****
```

```
Training an R-CNN Object Detector for the following object classes:
```

```
* stopSign
```

```
Step 1 of 3: Extracting region proposals from 27 training images...done.
```

```
Step 2 of 3: Training a neural network to classify objects in training data...
```

Epoch	Iteration	Time Elapsed (seconds)	Mini-batch Loss	Mini-batch Accuracy	Base Learning Rate
3	50	9.27	0.2895	96.88%	0.000001
5	100	14.77	0.2443	93.75%	0.000001
8	150	20.29	0.0013	100.00%	0.000001
10	200	25.94	0.1524	96.88%	0.000001

```
Network training complete.
```

```
Step 3 of 3: Training bounding box regression models for each object class...100.00%...done.
```

```
R-CNN training complete.
```

```
*****
```

Test the R-CNN detector on a test image.

```
img = imread('stopSignTest.jpg');
```

```
[bbox, score, label] = detect(rcnn, img, 'MiniBatchSize', 32);
```

Display strongest detection result.

```
[score, idx] = max(score);
```

```
bbox = bbox(idx, :);
```

```
annotation = sprintf('%s: (Confidence = %f)', label(idx), score);
```

```
detectedImg = insertObjectAnnotation(img, 'rectangle', bbox, annotation);
```

```
figure
```

```
imshow(detectedImg)
```



Remove the image directory from the path.

```
rmpath(imDir);
```

Input Arguments

detector — R-CNN object detector

`rcnnObjectDetector` object

R-CNN object detector, specified as an `rcnnObjectDetector` object. To create this object, call the `trainRCNNObjectDetector` function with training data as input.

I — Input image

H-by-*W*-by-*C* numeric array of images

Input image, specified as an *H*-by-*W*-by-*C* numeric array of images. Images must be real, nonsparse, grayscale or RGB image.

- *H*: Height
- *W*: Width
- *C*: The channel size in each image must be equal to the network's input channel size. For example, for grayscale images, *C* must be equal to 1. For RGB color images, it must be equal to 3.

The detector is sensitive to the range of the input image. Therefore, ensure that the input image range is similar to the range of the images used to train the detector. For example, if the detector was trained on `uint8` images, rescale this input image to the range `[0, 255]` by using the `im2uint8` or `rescale` function. The size of this input image should be comparable to the sizes of the images used in training. If these sizes are very different, the detector has difficulty detecting objects because the

scale of the objects in the input image differs from the scale of the objects the detector was trained to identify. Consider whether you used the `SmallestImageDimension` property during training to modify the size of training images.

Data Types: `uint8` | `uint16` | `int16` | `double` | `single` | `logical`

roi — Search region of interest

`[x y width height]` vector

Search region of interest, specified as an `[x y width height]` vector. The vector specifies the upper left corner and size of a region in pixels.

Name-Value Pair Arguments

Specify optional comma-separated pairs of `Name`, `Value` arguments. `Name` is the argument name and `Value` is the corresponding value. `Name` must appear inside quotes. You can specify several name and value pair arguments in any order as `Name1, Value1, ..., NameN, ValueN`.

Example: `'NumStrongestRegions', 1000`

NumStrongestRegions — Maximum number of strongest region proposals

2000 (default) | integer

Maximum number of strongest region proposals, specified as the comma-separated pair consisting of `'NumStrongestRegions'` and an integer. Reduce this value to speed up processing time at the cost of detection accuracy. To use all region proposals, specify this value as `Inf`.

SelectStrongest — Select strongest bounding box

`true` (default) | `false`

Select strongest bounding box for each detected object, specified as the comma-separated pair consisting of `'SelectStrongest'` and either `true` or `false`.

- `true` — Return the strongest bounding box per object. To select these boxes, `detect` calls the `selectStrongestBboxMulticlass` function, which uses nonmaximal suppression to eliminate overlapping bounding boxes based on their scores.

For example:

```
selectStrongestBboxMulticlass(bbox,scores, ...
    'RatioType','Min', ...
    'OverlapThreshold',0.5);
```

- `false` — Return all detected bounding boxes. You can then use a custom operation to eliminate overlapping bounding boxes.

MiniBatchSize — Size of smaller batches for R-CNN data processing

128 (default) | integer

Size of smaller batches for R-CNN data processing, specified as the comma-separated pair consisting of `'MiniBatchSize'` and an integer. Larger batch sizes lead to faster processing but take up more memory.

ExecutionEnvironment — Hardware resource

`'auto'` (default) | `'gpu'` | `'cpu'`

Hardware resource on which to run the detector, specified as the comma-separated pair consisting of 'ExecutionEnvironment' and 'auto', 'gpu', or 'cpu'. The table shows the valid hardware resource values.

Resource	Action
'auto'	Use a GPU if it is available. Otherwise, use the CPU.
'gpu'	Use the GPU. To use a GPU, you must have Parallel Computing Toolbox and a CUDA enabled NVIDIA GPU. If a suitable GPU is not available, the function returns an error. For information about the supported compute capabilities, see “GPU Support by Release” (Parallel Computing Toolbox).
'cpu'	Use the CPU.

Output Arguments

bboxes — Location of objects detected within image

M-by-4 matrix

Location of objects detected within the image, returned as an *M*-by-4 matrix defining *M* bounding boxes. Each row of `bboxes` contains a four-element vector of the form `[x y width height]`. This vector specifies the upper left corner and size of a bounding box in pixels.

scores — Detection scores

M-by-1 vector

Detection scores, returned as an *M*-by-1 vector. A higher score indicates higher confidence in the detection.

labels — Labels for bounding boxes

M-by-1 categorical array

Labels for bounding boxes, returned as an *M*-by-1 categorical array of *M* labels. You define the class names used to label the objects when you train the input detector.

See Also

Apps

[Image Labeler](#) | [Video Labeler](#)

Functions

`trainRCNNObjectDetector` | `selectStrongestBboxMulticlass`

Objects

`rcnnObjectDetector`

Introduced in R2016b

detect

Detect objects using Fast R-CNN object detector

Syntax

```
bboxes = detect(detector,I)
[bboxes,scores] = detect(detector,I)
[ ___,labels] = detect(detector,I)
[ ___ ] = detect( ___,roi)

detectionResults = detect(detector,ds)

[ ___ ] = detect( ___,Name,Value)
```

Description

`bboxes = detect(detector,I)` detects objects within a single image or an array of images, `I`, using a Fast R-CNN (regions with convolutional neural networks) object detector. The locations of objects detected are returned as a set of bounding boxes.

When using this function, use of a CUDA enabled NVIDIA GPU is highly recommended. The GPU reduces computation time significantly. Usage of the GPU requires Parallel Computing Toolbox. For information about the supported compute capabilities, see “GPU Support by Release” (Parallel Computing Toolbox).

`[bboxes,scores] = detect(detector,I)` also returns the detection scores for each bounding box.

`[___,labels] = detect(detector,I)` also returns a categorical array of labels assigned to the bounding boxes, using either of the preceding syntaxes. The labels used for object classes are defined during training using the `trainFastRCNNObjectDetector` function.

`[___] = detect(___,roi)` detects objects within the rectangular search region specified by `roi`.

`detectionResults = detect(detector,ds)` detects objects within the series of images returned by the `read` function of the input datastore.

`[___] = detect(___,Name,Value)` specifies options using one or more `Name,Value` pair arguments. For example, `detect(detector,I,'NumStrongestRegions',1000)` limits the number of strongest region proposals to 1000.

Examples

Detect Vehicles Using Faster R-CNN

Detect vehicles within an image by using a Faster R-CNN object detector.

Load a Faster R-CNN object detector pretrained to detect vehicles.

```
data = load('fasterRCNNVehicleTrainingData.mat', 'detector');  
detector = data.detector;
```

Read in a test image.

```
I = imread('highway.png');  
imshow(I)
```



Run the detector on the image and inspect the results. The labels come from the `ClassNames` property of the detector.

```
[bboxes,scores,labels] = detect(detector,I)
```

```
bboxes = 2x4
```

```
    150    86    80    72  
     91    89    67    48
```

```
scores = 2x1 single column vector
```

```
    1.0000  
    0.9001
```

```
labels = 2x1 categorical
```

```
    vehicle  
    vehicle
```

The detector has high confidence in the detections. Annotate the image with the bounding boxes for the detections and the corresponding detection scores.

```
detectedI = insertObjectAnnotation(I, 'Rectangle', bboxes, cellstr(labels));  
figure  
imshow(detectedI)
```

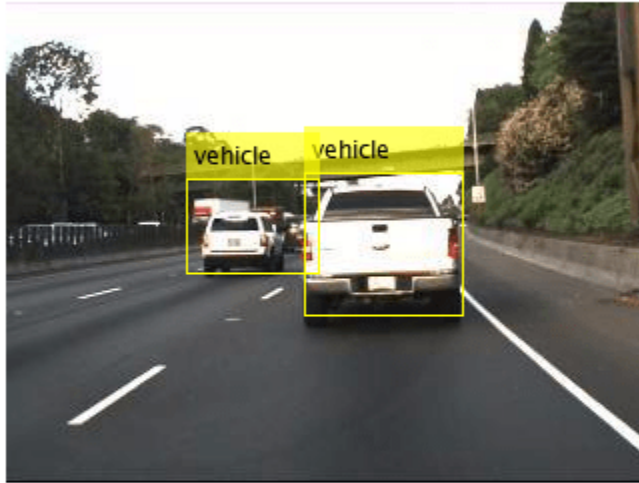

Input Arguments

detector — Fast R-CNN object detector

`fastRCNNObjectDetector` object

Fast R-CNN object detector, specified as a `fastRCNNObjectDetector` object. To create this object, call the `trainFastRCNNObjectDetector` function with training data as input.

I — Input image

H-by-*W*-by-*C*-by-*B* numeric array of images

Input image, specified as an *H*-by-*W*-by-*C*-by-*B* numeric array of images. Images must be real, nonsparse, grayscale or RGB image.

- *H*: Height
- *W*: Width
- *C*: The channel size in each image must be equal to the network's input channel size. For example, for grayscale images, *C* must be equal to 1. For RGB color images, it must be equal to 3.
- *B*: The number of images in the array.

The detector is sensitive to the range of the input image. Therefore, ensure that the input image range is similar to the range of the images used to train the detector. For example, if the detector was trained on `uint8` images, rescale this input image to the range `[0, 255]` by using the `im2uint8` or `rescale` function. The size of this input image should be comparable to the sizes of the images used in training. If these sizes are very different, the detector has difficulty detecting objects because the

scale of the objects in the input image differs from the scale of the objects the detector was trained to identify. Consider whether you used the `SmallestImageDimension` property during training to modify the size of training images.

Data Types: `uint8` | `uint16` | `int16` | `double` | `single` | `logical`

ds — Datastore

datastore object

Datastore, specified as a datastore object containing a collection of images. Each image must be a grayscale, RGB, or multichannel image. The function processes only the first column of the datastore, which must contain images and must be cell arrays or tables with multiple columns.

roi — Search region of interest

`[x y width height]` vector

Search region of interest, specified as an `[x y width height]` vector. The vector specifies the upper left corner and size of a region in pixels.

Name-Value Pair Arguments

Specify optional comma-separated pairs of `Name`, `Value` arguments. `Name` is the argument name and `Value` is the corresponding value. `Name` must appear inside quotes. You can specify several name and value pair arguments in any order as `Name1, Value1, ..., NameN, ValueN`.

Example: `'NumStrongestRegions', 1000`

Threshold — Detection threshold

0.5 (default) | scalar in the range [0, 1]

Detection threshold, specified as a scalar in the range [0, 1]. Detections that have scores less than this threshold value are removed. To reduce false positives, increase this value.

NumStrongestRegions — Maximum number of strongest region proposals

2000 (default) | positive integer | `Inf`

Maximum number of strongest region proposals, specified as the comma-separated pair consisting of `'NumStrongestRegions'` and a positive integer. Reduce this value to speed up processing time at the cost of detection accuracy. To use all region proposals, specify this value as `Inf`.

SelectStrongest — Select strongest bounding box

`true` (default) | `false`

Select the strongest bounding box for each detected object, specified as the comma-separated pair consisting of `'SelectStrongest'` and either `true` or `false`.

- `true` — Return the strongest bounding box per object. To select these boxes, `detect` calls the `selectStrongestBboxMulticlass` function, which uses nonmaximal suppression to eliminate overlapping bounding boxes based on their confidence scores.

For example:

```
selectStrongestBboxMulticlass(bbox,scores, ...
    'RatioType','Min', ...
    'OverlapThreshold',0.5);
```

- `false` — Return all detected bounding boxes. You can then create your own custom operation to eliminate overlapping bounding boxes.

MinSize — Minimum region size

[height width] vector

Minimum region size that contains a detected object, specified as the comma-separated pair consisting of 'MinSize' and a *[height width]* vector. Units are in pixels.

By default, MinSize is the smallest object that the trained `detector` can detect.

MaxSize — Maximum region size

`size(I)` (default) | *[height width]* vector

Maximum region size that contains a detected object, specified as the comma-separated pair consisting of 'MaxSize' and a *[height width]* vector. Units are in pixels.

To reduce computation time, set this value to the known maximum region size for the objects being detected in the image. By default, 'MaxSize' is set to the height and width of the input image, `I`.

MiniBatchSize — Minimum batch size

128 (default) | scalar

Minimum batch size, specified as the comma-separated pair consisting of 'MiniBatchSize' and a scalar value. Use the `MiniBatchSize` to process a large collection of images. Images are grouped into minibatches and processed as a batch to improve computation efficiency. Increase the minibatch size to decrease processing time. Decrease the size to use less memory.

ExecutionEnvironment — Hardware resource

'auto' (default) | 'gpu' | 'cpu'

Hardware resource on which to run the detector, specified as the comma-separated pair consisting of 'ExecutionEnvironment' and 'auto', 'gpu', or 'cpu'.

- 'auto' — Use a GPU if it is available. Otherwise, use the CPU.
- 'gpu' — Use the GPU. To use a GPU, you must have Parallel Computing Toolbox and a CUDA enabled NVIDIA GPU. If a suitable GPU is not available, the function returns an error. For information about the supported compute capabilities, see “GPU Support by Release” (Parallel Computing Toolbox).
- 'cpu' — Use the CPU.

Output Arguments

bboxes — Location of objects detected

M-by-4 matrix | *B*-by-1 cell array

Location of objects detected within the input image or images, returned as an *M*-by-4 matrix or a *B*-by-1 cell array. *M* is the number of bounding boxes in an image, and *B* is the number of *M*-by-4 matrices when the input contains an array of images.

Each row of `bboxes` contains a four-element vector of the form `[x y width height]`. This vector specifies the upper left corner and size of that corresponding bounding box in pixels.

scores — Detection scores

M-by-1 vector | *B*-by-1 cell array

Detection confidence scores, returned as an *M*-by-1 vector or a *B*-by-1 cell array. *M* is the number of bounding boxes in an image, and *B* is the number of *M*-by-1 vectors when the input contains an array of images. A higher score indicates higher confidence in the detection.

labels — Labels for bounding boxes

M-by-1 categorical array | *B*-by-1 cell array

Labels for bounding boxes, returned as an *M*-by-1 categorical array or a *B*-by-1 cell array. *M* is the number of labels in an image, and *B* is the number of *M*-by-1 categorical arrays when the input contains an array of images. You define the class names used to label the objects when you train the input detector.

detectionResults — Detection results

3-column table

Detection results, returned as a 3-column table with variable names, *Boxes*, *Scores*, and *Labels*. The *Boxes* column contains *M*-by-4 matrices, of *M* bounding boxes for the objects found in the image. Each row contains a bounding box as a 4-element vector in the format $[x,y,width,height]$. The format specifies the upper-left corner location and size in pixels of the bounding box in the corresponding image.

See Also**Apps**

Image Labeler | **Video Labeler**

Functions

`trainFastRCNNObjectDetector` | `selectStrongestBboxMulticlass`

Objects

`fastRCNNObjectDetector`

Topics

“Datastores for Deep Learning” (Deep Learning Toolbox)

Introduced in R2017a

detect

Detect objects using Faster R-CNN object detector

Syntax

```
bboxes = detect(detector,I)
[bboxes,scores] = detect(detector,I)
[ ___,labels] = detect(detector,I)

detectionResults = detect(detector,ds)

[ ___ ] = detect( ___, roi)
[ ___ ] = detect( ___,Name,Value)
```

Description

`bboxes = detect(detector,I)` detects objects within a single image or an array of images, `I`, using a Faster R-CNN (regions with convolutional neural networks) object detector. The locations of objects detected are returned as a set of bounding boxes.

When using this function, use of a CUDA enabled NVIDIA GPU is highly recommended. The GPU reduces computation time significantly. Usage of the GPU requires Parallel Computing Toolbox. For information about the supported compute capabilities, see “GPU Support by Release” (Parallel Computing Toolbox).

`[bboxes,scores] = detect(detector,I)` also returns the detection scores for each bounding box.

`[___,labels] = detect(detector,I)` also returns a categorical array of labels assigned to the bounding boxes, using either of the preceding syntaxes. The labels used for object classes are defined during training using the `trainFasterRCNNObjectDetector` function.

`detectionResults = detect(detector,ds)` detects objects within the series of images returned by the `read` function of the input datastore.

`[___] = detect(___, roi)` detects objects within the rectangular search region specified by `roi`.

`[___] = detect(___,Name,Value)` specifies options using one or more `Name,Value` pair arguments. For example, `detect(detector,I,'NumStrongestRegions',1000)` limits the number of strongest region proposals to 1000.

Examples

Detect Vehicles Using Faster R-CNN

Detect vehicles within an image by using a Faster R-CNN object detector.

Load a Faster R-CNN object detector pretrained to detect vehicles.

```
data = load('fasterRCNNVehicleTrainingData.mat', 'detector');  
detector = data.detector;
```

Read in a test image.

```
I = imread('highway.png');  
imshow(I)
```



Run the detector on the image and inspect the results. The labels come from the `ClassNames` property of the detector.

```
[bboxes,scores,labels] = detect(detector,I)
```

```
bboxes = 2x4
```

```
    150    86    80    72  
     91    89    67    48
```

```
scores = 2x1 single column vector
```

```
    1.0000  
    0.9001
```

```
labels = 2x1 categorical
```

```
    vehicle  
    vehicle
```

The detector has high confidence in the detections. Annotate the image with the bounding boxes for the detections and the corresponding detection scores.

```
detectedI = insertObjectAnnotation(I, 'Rectangle', bboxes, cellstr(labels));  
figure  
imshow(detectedI)
```

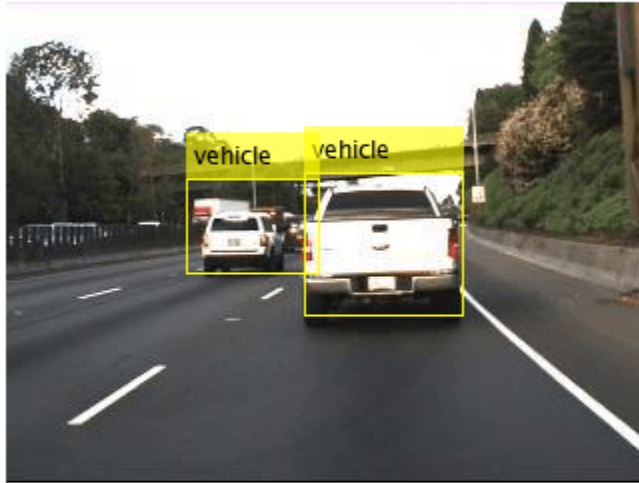

Input Arguments

detector — Faster R-CNN object detector

`fasterRCNNObjectDetector` object

Faster R-CNN object detector, specified as a `fasterRCNNObjectDetector` object. To create this object, call the `trainFasterRCNNObjectDetector` function with training data as input.

I — Input image

H-by-*W*-by-*C*-by-*B* numeric array of images

Input image, specified as an *H*-by-*W*-by-*C*-by-*B* numeric array of images. Images must be real, nonsparse, grayscale or RGB image.

- *H*: Height
- *W*: Width
- *C*: The channel size in each image must be equal to the network's input channel size. For example, for grayscale images, *C* must be equal to 1. For RGB color images, it must be equal to 3.
- *B*: The number of images in the array.

The detector is sensitive to the range of the input image. Therefore, ensure that the input image range is similar to the range of the images used to train the detector. For example, if the detector was trained on `uint8` images, rescale this input image to the range `[0, 255]` by using the `im2uint8` or `rescale` function. The size of this input image should be comparable to the sizes of the images used in training. If these sizes are very different, the detector has difficulty detecting objects because the

scale of the objects in the input image differs from the scale of the objects the detector was trained to identify. Consider whether you used the `SmallestImageDimension` property during training to modify the size of training images.

Data Types: `uint8` | `uint16` | `int16` | `double` | `single` | `logical`

ds — Datastore

datastore object

Datastore, specified as a datastore object containing a collection of images. Each image must be a grayscale, RGB, or multichannel image. The function processes only the first column of the datastore, which must contain images and must be cell arrays or tables with multiple columns.

roi — Search region of interest

`[x y width height]` vector

Search region of interest, specified as an `[x y width height]` vector. The vector specifies the upper left corner and size of a region in pixels.

Name-Value Pair Arguments

Specify optional comma-separated pairs of `Name`, `Value` arguments. `Name` is the argument name and `Value` is the corresponding value. `Name` must appear inside quotes. You can specify several name and value pair arguments in any order as `Name1, Value1, ..., NameN, ValueN`.

Example: `'NumStrongestRegions', 1000`

Threshold — Detection threshold

0.5 (default) | scalar in the range [0, 1]

Detection threshold, specified as a scalar in the range [0, 1]. Detections that have scores less than this threshold value are removed. To reduce false positives, increase this value.

NumStrongestRegions — Maximum number of strongest region proposals

2000 (default) | positive integer | `Inf`

Maximum number of strongest region proposals, specified as the comma-separated pair consisting of `'NumStrongestRegions'` and a positive integer. Reduce this value to speed up processing time at the cost of detection accuracy. To use all region proposals, specify this value as `Inf`.

SelectStrongest — Select strongest bounding box

`true` (default) | `false`

Select the strongest bounding box for each detected object, specified as the comma-separated pair consisting of `'SelectStrongest'` and either `true` or `false`.

- `true` — Return the strongest bounding box per object. To select these boxes, `detect` calls the `selectStrongestBboxMulticlass` function, which uses nonmaximal suppression to eliminate overlapping bounding boxes based on their confidence scores.

For example:

```
selectStrongestBboxMulticlass(bbox,scores, ...
    'RatioType','Min', ...
    'OverlapThreshold',0.5);
```

- `false` — Return all detected bounding boxes. You can then create your own custom operation to eliminate overlapping bounding boxes.

MinSize — Minimum region size

[height width] vector

Minimum region size that contains a detected object, specified as the comma-separated pair consisting of 'MinSize' and a *[height width]* vector. Units are in pixels.

By default, MinSize is the smallest object that the trained `detector` can detect.

MaxSize — Maximum region size

`size(I)` (default) | *[height width]* vector

Maximum region size that contains a detected object, specified as the comma-separated pair consisting of 'MaxSize' and a *[height width]* vector. Units are in pixels.

To reduce computation time, set this value to the known maximum region size for the objects being detected in the image. By default, 'MaxSize' is set to the height and width of the input image, `I`.

MiniBatchSize — Minimum batch size

128 (default) | scalar

Minimum batch size, specified as the comma-separated pair consisting of 'MiniBatchSize' and a scalar value. Use the `MiniBatchSize` to process a large collection of images. Images are grouped into minibatches and processed as a batch to improve computation efficiency. Increase the minibatch size to decrease processing time. Decrease the size to use less memory.

ExecutionEnvironment — Hardware resource

'auto' (default) | 'gpu' | 'cpu'

Hardware resource on which to run the detector, specified as the comma-separated pair consisting of 'ExecutionEnvironment' and 'auto', 'gpu', or 'cpu'.

- 'auto' — Use a GPU if it is available. Otherwise, use the CPU.
- 'gpu' — Use the GPU. To use a GPU, you must have Parallel Computing Toolbox and a CUDA enabled NVIDIA GPU. If a suitable GPU is not available, the function returns an error. For information about the supported compute capabilities, see “GPU Support by Release” (Parallel Computing Toolbox).
- 'cpu' — Use the CPU.

Output Arguments

bboxes — Location of objects detected

M-by-4 matrix | *B*-by-1 cell array

Location of objects detected within the input image or images, returned as an *M*-by-4 matrix or a *B*-by-1 cell array. *M* is the number of bounding boxes in an image, and *B* is the number of *M*-by-4 matrices when the input contains an array of images.

Each row of `bboxes` contains a four-element vector of the form `[x y width height]`. This vector specifies the upper left corner and size of that corresponding bounding box in pixels.

scores — Detection scores

M-by-1 vector | *B*-by-1 cell array

Detection confidence scores, returned as an *M*-by-1 vector or a *B*-by-1 cell array. *M* is the number of bounding boxes in an image, and *B* is the number of *M*-by-1 vectors when the input contains an array of images. A higher score indicates higher confidence in the detection.

labels — Labels for bounding boxes

M-by-1 categorical array | *B*-by-1 cell array

Labels for bounding boxes, returned as an *M*-by-1 categorical array or a *B*-by-1 cell array. *M* is the number of labels in an image, and *B* is the number of *M*-by-1 categorical arrays when the input contains an array of images. You define the class names used to label the objects when you train the input detector.

detectionResults — Detection results

3-column table

Detection results, returned as a 3-column table with variable names, *Boxes*, *Scores*, and *Labels*. The *Boxes* column contains *M*-by-4 matrices, of *M* bounding boxes for the objects found in the image. Each row contains a bounding box as a 4-element vector in the format $[x,y,width,height]$. The format specifies the upper-left corner location and size in pixels of the bounding box in the corresponding image.

See Also

Apps

Image Labeler | **Video Labeler**

Functions

`trainYOLOv2ObjectDetector` | `trainFasterRCNNObjectDetector` |
`selectStrongestBboxMulticlass` | `evaluateDetectionMissRate` |
`evaluateDetectionPrecision`

Objects

`fasterRCNNObjectDetector` | `boxLabelDatastore`

Topics

“Datastores for Deep Learning” (Deep Learning Toolbox)

Introduced in R2017a

detect

Detect objects using YOLO v2 object detector

Syntax

```
bboxes = detect(detector,I)
[bboxes,scores] = detect(detector,I)
[ ___,labels] = detect(detector,I)

detectionResults = detect(detector,ds)

[ ___ ] = detect( ___, roi)
[ ___ ] = detect( ___,Name,Value)
```

Description

`bboxes = detect(detector,I)` detects objects within a single image or an array of images, `I`, using you only look once version 2 (YOLO v2) object detector. The input size of the image must be greater than or equal to the network input size of the pretrained detector. The locations of objects detected are returned as a set of bounding boxes.

When using this function, use of a CUDA-enabled NVIDIA GPU is highly recommended. The GPU reduces computation time significantly. Usage of the GPU requires Parallel Computing Toolbox. For information about the supported compute capabilities, see “GPU Support by Release” (Parallel Computing Toolbox).

`[bboxes,scores] = detect(detector,I)` also returns the class-specific confidence scores for each bounding box.

`[___,labels] = detect(detector,I)` returns a categorical array of labels assigned to the bounding boxes in addition to the output arguments from the previous syntax. The labels used for object classes are defined during training using the `trainYOLOv2ObjectDetector` function.

`detectionResults = detect(detector,ds)` detects objects within all the images returned by the `read` function of the input datastore.

`[___] = detect(___, roi)` detects objects within the rectangular search region specified by `roi`. Use output arguments from any of the previous syntaxes. Specify input arguments from any of the previous syntaxes.

`[___] = detect(___,Name,Value)` specifies options using one or more `Name,Value` pair arguments in addition to the input arguments in any of the preceding syntaxes.

Examples

Detect Vehicles Using YOLO v2 Object Detection Network

Load a YOLO v2 object detector pretrained to detect vehicles.

```
vehicleDetector = load('yolov2VehicleDetector.mat','detector');  
detector = vehicleDetector.detector;
```

Read a test image into the workspace.

```
I = imread('highway.png');
```

Display the input test image.

```
imshow(I);
```



Run the pretrained YOLO v2 object detector on the test image. Inspect the results for vehicle detection. The labels are derived from the `ClassNames` property of the detector.

```
[bboxes,scores,labels] = detect(detector,I)
```

```
bboxes = 1x4
```

```
    78    81    64    63
```

```
scores = single
```

```
    0.6224
```

```
labels = categorical
```

```
    vehicle
```

Annotate the image with the bounding boxes for the detections.

```
if ~isempty(bboxes)  
    detectedI = insertObjectAnnotation(I,'rectangle',bboxes,cellstr(labels));  
end  
figure  
imshow(detectedI)
```

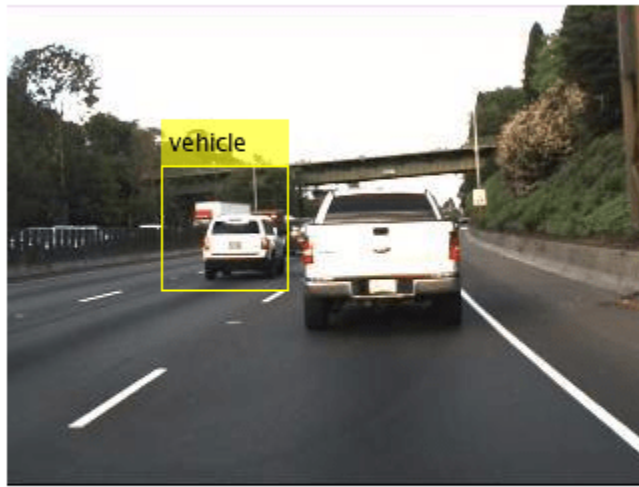

Input Arguments

detector — YOLO v2 object detector

`yolov2objectDetector` object

YOLO v2 object detector, specified as a `yolov2objectDetector` object. To create this object, call the `trainYOLOv2objectDetector` function with the training data as input.

I — Input image

H-by-W-by-C-by-B numeric array of images

Input image, specified as an *H-by-W-by-C-by-B* numeric array of images. Images must be real, nonsparse, grayscale or RGB image.

- *H*: Height
- *W*: Width
- *C*: The channel size in each image must be equal to the network's input channel size. For example, for grayscale images, *C* must be equal to 1. For RGB color images, it must be equal to 3.
- *B*: The number of images in the array.

The detector is sensitive to the range of the input image. Therefore, ensure that the input image range is similar to the range of the images used to train the detector. For example, if the detector was trained on `uint8` images, rescale this input image to the range `[0, 255]` by using the `im2uint8` or `rescale` function. The size of this input image should be comparable to the sizes of the images used in training. If these sizes are very different, the detector has difficulty detecting objects because the scale of the objects in the input image differs from the scale of the objects the detector was trained to identify. Consider whether you used the `SmallestImageDimension` property during training to modify the size of training images.

Data Types: `uint8` | `uint16` | `int16` | `double` | `single` | `logical`

ds — Datastore

datastore object

Datastore, specified as a datastore object containing a collection of images. Each image must be a grayscale, RGB, or multichannel image. The function processes only the first column of the datastore, which must contain images and must be cell arrays or tables with multiple columns.

roi — Search region of interest*[x y width height]* vector

Search region of interest, specified as an *[x y width height]* vector. The vector specifies the upper left corner and size of a region in pixels.

Name-Value Pair Arguments

Specify optional comma-separated pairs of `Name`, `Value` arguments. `Name` is the argument name and `Value` is the corresponding value. `Name` must appear inside quotes. You can specify several name and value pair arguments in any order as `Name1`, `Value1`, ..., `NameN`, `ValueN`.

Example: `detect(detector,I,'Threshold',0.25)`

Threshold — Detection threshold

0.5 (default) | scalar in the range [0, 1]

Detection threshold, specified as a comma-separated pair consisting of 'Threshold' and a scalar in the range [0, 1]. Detections that have scores less than this threshold value are removed. To reduce false positives, increase this value.

SelectStrongest — Select strongest bounding box

true (default) | false

Select the strongest bounding box for each detected object, specified as the comma-separated pair consisting of 'SelectStrongest' and either true or false.

- `true` — Returns the strongest bounding box per object. The method calls the `selectStrongestBboxMulticlass` function, which uses nonmaximal suppression to eliminate overlapping bounding boxes based on their confidence scores.

By default, the `selectStrongestBboxMulticlass` function is called as follows

```
selectStrongestBboxMulticlass(bbox,scores,...
                             'RatioType','Union',...
                             'OverlapThreshold',0.5);
```

- `false` — Return all the detected bounding boxes. You can then write your own custom method to eliminate overlapping bounding boxes.

MinSize — Minimum region size[1 1] (default) | vector of the form *[height width]*

Minimum region size, specified as the comma-separated pair consisting of 'MinSize' and a vector of the form *[height width]*. Units are in pixels. The minimum region size defines the size of the smallest region containing the object.

By default, `MinSize` is 1-by-1.

MaxSize — Maximum region size

`size(I)` (default) | vector of the form [*height width*]

Maximum region size, specified as the comma-separated pair consisting of 'MaxSize' and a vector of the form [*height width*]. Units are in pixels. The maximum region size defines the size of the largest region containing the object.

By default, 'MaxSize' is set to the height and width of the input image, I. To reduce computation time, set this value to the known maximum region size for the objects that can be detected in the input test image.

MiniBatchSize — Minimum batch size

128 (default) | scalar

Minimum batch size, specified as the comma-separated pair consisting of 'MiniBatchSize' and a scalar value. Use the MiniBatchSize to process a large collection of image. Images are grouped into minibatches and processed as a batch to improve computation efficiency. Increase the minibatch size to decrease processing time. Decrease the size to use less memory.

ExecutionEnvironment — Hardware resource

'auto' (default) | 'gpu' | 'cpu'

Hardware resource on which to run the detector, specified as the comma-separated pair consisting of 'ExecutionEnvironment' and 'auto', 'gpu', or 'cpu'.

- 'auto' — Use a GPU if it is available. Otherwise, use the CPU.
- 'gpu' — Use the GPU. To use a GPU, you must have Parallel Computing Toolbox and a CUDA-enabled NVIDIA GPU. If a suitable GPU is not available, the function returns an error. For information about the supported compute capabilities, see “GPU Support by Release” (Parallel Computing Toolbox).
- 'cpu' — Use the CPU.

Acceleration — Performance optimization

'auto' (default) | 'mex' | 'none'

Performance optimization, specified as the comma-separated pair consisting of 'Acceleration' and one of the following:

- 'auto' — Automatically apply a number of optimizations suitable for the input network and hardware resource.
- 'mex' — Compile and execute a MEX function. This option is available when using a GPU only. Using a GPU requires Parallel Computing Toolbox and a CUDA enabled NVIDIA GPU. If Parallel Computing Toolbox or a suitable GPU is not available, then the function returns an error. For information about the supported compute capabilities, see “GPU Support by Release” (Parallel Computing Toolbox).
- 'none' — Disable all acceleration.

The default option is 'auto'. If 'auto' is specified, MATLAB applies a number of compatible optimizations. If you use the 'auto' option, MATLAB does not ever generate a MEX function.

Using the 'Acceleration' options 'auto' and 'mex' can offer performance benefits, but at the expense of an increased initial run time. Subsequent calls with compatible parameters are faster. Use performance optimization when you plan to call the function multiple times using new input data.

The 'mex' option generates and executes a MEX function based on the network and parameters used in the function call. You can have several MEX functions associated with a single network at one time. Clearing the network variable also clears any MEX functions associated with that network.

The 'mex' option is only available for input data specified as a numeric array, cell array of numeric arrays, table, or image datastore. No other types of datastore support the 'mex' option.

The 'mex' option is only available when you are using a GPU. You must also have a C/C++ compiler installed. For setup instructions, see “MEX Setup” (GPU Coder).

'mex' acceleration does not support all layers. For a list of supported layers, see “Supported Layers” (GPU Coder).

Output Arguments

bboxes — Location of objects detected

M-by-4 matrix | *B*-by-1 cell array

Location of objects detected within the input image or images, returned as an *M*-by-4 matrix or a *B*-by-1 cell array. *M* is the number of bounding boxes in an image, and *B* is the number of *M*-by-4 matrices when the input contains an array of images.

Each row of **bboxes** contains a four-element vector of the form [*x* *y* *width* *height*]. This vector specifies the upper left corner and size of that corresponding bounding box in pixels.

scores — Detection scores

M-by-1 vector | *B*-by-1 cell array

Detection confidence scores, returned as an *M*-by-1 vector or a *B*-by-1 cell array. *M* is the number of bounding boxes in an image, and *B* is the number of *M*-by-1 vectors when the input contains an array of images. A higher score indicates higher confidence in the detection.

labels — Labels for bounding boxes

M-by-1 categorical array | *B*-by-1 cell array

Labels for bounding boxes, returned as an *M*-by-1 categorical array or a *B*-by-1 cell array. *M* is the number of labels in an image, and *B* is the number of *M*-by-1 categorical arrays when the input contains an array of images. You define the class names used to label the objects when you train the input detector.

detectionResults — Detection results

3-column table

Detection results, returned as a 3-column table with variable names, *Boxes*, *Scores*, and *Labels*. The *Boxes* column contains *M*-by-4 matrices, of *M* bounding boxes for the objects found in the image. Each row contains a bounding box as a 4-element vector in the format [*x*,*y*,*width*,*height*]. The format specifies the upper-left corner location and size in pixels of the bounding box in the corresponding image.

More About

Data Preprocessing

By default, the detect function preprocesses the test image for object detection by:

- Resizing it to a nearest possible image size used for training the YOLO v2 network. The function determines the nearest possible image size from the `TrainingImageSize` property of the `yoloV2ObjectDetector` object.
- Normalizing its pixel values to lie in same range as that of the images used to train the YOLO v2 object detector. For example, if the detector was trained on `uint8` images, the test image must also have pixel values in the range `[0, 255]`. Otherwise, use the `im2uint8` or `rescale` function to rescale the pixel values in the test image.

See Also

Apps

[Image Labeler](#) | [Video Labeler](#)

Functions

[selectStrongestBboxMulticlass](#) | [trainYOLOv2ObjectDetector](#) | [evaluateDetectionMissRate](#) | [evaluateDetectionPrecision](#)

Objects

[yoloV2ObjectDetector](#) | [boxLabelDatastore](#)

Topics

[“Create YOLO v2 Object Detection Network”](#)
[“Object Detection Using YOLO v2 Deep Learning”](#)
[“Estimate Anchor Boxes From Training Data”](#)
[“Code Generation for Object Detection by Using YOLO v2”](#)
[“Getting Started with YOLO v2”](#)
[“Anchor Boxes for Object Detection”](#)
[“Datastores for Deep Learning”](#) (Deep Learning Toolbox)

Introduced in R2019a

classifyRegions

Classify objects in image regions using R-CNN object detector

Syntax

```
[labels,scores] = classifyRegions(detector,I,rois)
[labels,scores,allScores] = classifyRegions(detector,I,rois)
[___] = classifyRegions(___ Name,Value)
```

Description

`[labels,scores] = classifyRegions(detector,I,rois)` classifies objects within the regions of interest of image `I`, using an R-CNN (regions with convolutional neural networks) object detector. For each region, `classifyRegions` returns the class label with the corresponding highest classification score.

When using this function, use of a CUDA enabled NVIDIA GPU is highly recommended. The GPU reduces computation time significantly. Usage of the GPU requires Parallel Computing Toolbox. For information about the supported compute capabilities, see “GPU Support by Release” (Parallel Computing Toolbox).

`[labels,scores,allScores] = classifyRegions(detector,I,rois)` also returns all the classification scores of each region. The scores are returned in an M -by- N matrix of M regions and N class labels.

`[___] = classifyRegions(___ Name,Value)` specifies options using one or more `Name,Value` pair arguments. For example, `classifyRegions(detector,I,rois,'ExecutionEnvironment','cpu')` classifies objects within image regions using only the CPU hardware.

Examples

Classify Multiple Image Regions

Load a pretrained detector.

```
load('rcnnStopSigns.mat','rcnn')
```

Read the test image.

```
img = imread('stopSignTest.jpg');
```

Specify multiple regions to classify within the test image.

```
rois = [416 143 33 27
        347 168 36 54];
```

Classify regions.

```
[labels,scores] = classifyRegions(rcnn,img,rois);
detectedImg = insertObjectAnnotation(img,'rectangle',rois,cellstr(labels));
```

```
figure  
imshow(detectedImg)
```



Input Arguments

detector — R-CNN object detector

`rcnnObjectDetector` object

R-CNN object detector, specified as an `rcnnObjectDetector` object. To create this object, call the `trainRCNNObjectDetector` function with training data as input.

I — Input image

grayscale image | RGB image

Input image, specified as a real, nonsparse, grayscale or RGB image.

Data Types: `uint8` | `uint16` | `int16` | `double` | `single` | `logical`

rois — Regions of interest

M -by-4 matrix

Regions of interest within the image, specified as an M -by-4 matrix defining M rectangular regions. Each row contains a four-element vector of the form $[x\ y\ width\ height]$. This vector specifies the upper left corner and size of a region in pixels.

Name-Value Pair Arguments

Specify optional comma-separated pairs of `Name`, `Value` arguments. `Name` is the argument name and `Value` is the corresponding value. `Name` must appear inside quotes. You can specify several name and value pair arguments in any order as `Name1, Value1, ..., NameN, ValueN`.

Example: `'MiniBatchSize', 64`

MiniBatchSize — Size of smaller batches for R-CNN data processing

128 (default) | integer

Size of smaller batches for R-CNN data processing, specified as the comma-separated pair consisting of `'MiniBatchSize'` and an integer. Larger batch sizes lead to faster processing but take up more memory.

ExecutionEnvironment — Hardware resource

'auto' (default) | 'gpu' | 'cpu'

Hardware resource used to classify image regions, specified as the comma-separated pair consisting of `'ExecutionEnvironment'` and `'auto'`, `'gpu'`, or `'cpu'`.

- `'auto'` — Use a GPU if it is available. Otherwise, use the CPU.
- `'gpu'` — Use the GPU. To use a GPU, you must have Parallel Computing Toolbox and a CUDA enabled NVIDIA GPU. If a suitable GPU is not available, the function returns an error. For information about the supported compute capabilities, see “GPU Support by Release” (Parallel Computing Toolbox).
- `'cpu'` — Use the CPU.

Example: `'ExecutionEnvironment', 'cpu'`

Output Arguments

Labels — Classification labels of regions

M-by-1 categorical array

Classification labels of regions, returned as an *M*-by-1 categorical array. *M* is the number of regions of interest in `rois`. Each class name in `labels` corresponds to a classification score in `scores` and a region of interest in `rois`. `classifyRegions` obtains the class names from the input detector.

scores — Highest classification score per region

M-by-1 vector of values in the range [0, 1]

Highest classification score per region, returned as an *M*-by-1 vector of values in the range [0, 1]. *M* is the number of regions of interest in `rois`. Each classification score in `scores` corresponds to a class name in `labels` and a region of interest in `rois`. A higher score indicates higher confidence in the classification.

allScores — All classification scores per region

M-by-*N* matrix of values in the range [0, 1]

All classification scores per region, returned as an *M*-by-*N* matrix of values in the range [0, 1]. *M* is the number of regions in `rois`. *N* is the number of class names stored in the input detector. Each row of classification scores in `allScores` corresponds to a region of interest in `rois`. A higher score indicates higher confidence in the classification.

See Also

Apps

Image Labeler | Video Labeler

Functions

`trainRCNNObjectDetector`

Objects

`rcnnObjectDetector`

Introduced in R2016b

classifyRegions

Classify objects in image regions using Fast R-CNN object detector

Syntax

```
[labels,scores] = classifyRegions(detector,I,rois)
[labels,scores,allScores] = classifyRegions(detector,I,rois)
[___] = classifyRegions( ___, 'ExecutionEnvironment', resource)
```

Description

`[labels,scores] = classifyRegions(detector,I,rois)` classifies objects within the regions of interest of image `I`, using a Fast R-CNN (regions with convolutional neural networks) object detector. For each region, `classifyRegions` returns the class label with the corresponding highest classification score.

When using this function, use of a CUDA enabled NVIDIA GPU is highly recommended. The GPU reduces computation time significantly. Usage of the GPU requires Parallel Computing Toolbox. For information about the supported compute capabilities, see “GPU Support by Release” (Parallel Computing Toolbox).

`[labels,scores,allScores] = classifyRegions(detector,I,rois)` also returns all the classification scores of each region. The scores are returned in an M -by- N matrix of M regions and N class labels.

`[___] = classifyRegions(___, 'ExecutionEnvironment', resource)` specifies the hardware resource used to classify object within image regions: 'auto', 'cpu', or 'gpu'. You can use this syntax with either of the preceding syntaxes.

Examples

Classify Image Regions Using Fast R-CNN

Configure a Fast R-CNN object detector and use it to classify objects within multiple regions of an image.

Load a `fastRCNNObjectDetector` object that is pretrained to detect stop signs.

```
data = load('rcnnStopSigns.mat','fastRCNN');
fastRCNN = data.fastRCNN;
```

Read in a test image containing a stop sign.

```
I = imread('stopSignTest.jpg');
figure
imshow(I)
```



Specify regions of interest to classify within the test image.

```
rois = [416  143  33  27
        347  168  36  54];
```

Classify the image regions and inspect the output labels and classification scores. The labels come from the `ClassNames` property of the detector.

```
[labels,scores] = classifyRegions(fastRCNN,I,rois)
```

```
labels = 2x1 categorical
    stopSign
    Background
```

```
scores = 2x1 single column vector
```

```
    0.9969
    1.0000
```

The detector has high confidence in the classifications. Display the classified regions on the test image.

```
detectedI = insertObjectAnnotation(I,'rectangle',rois,cellstr(labels));
```

```
figure
imshow(detectedI)
```

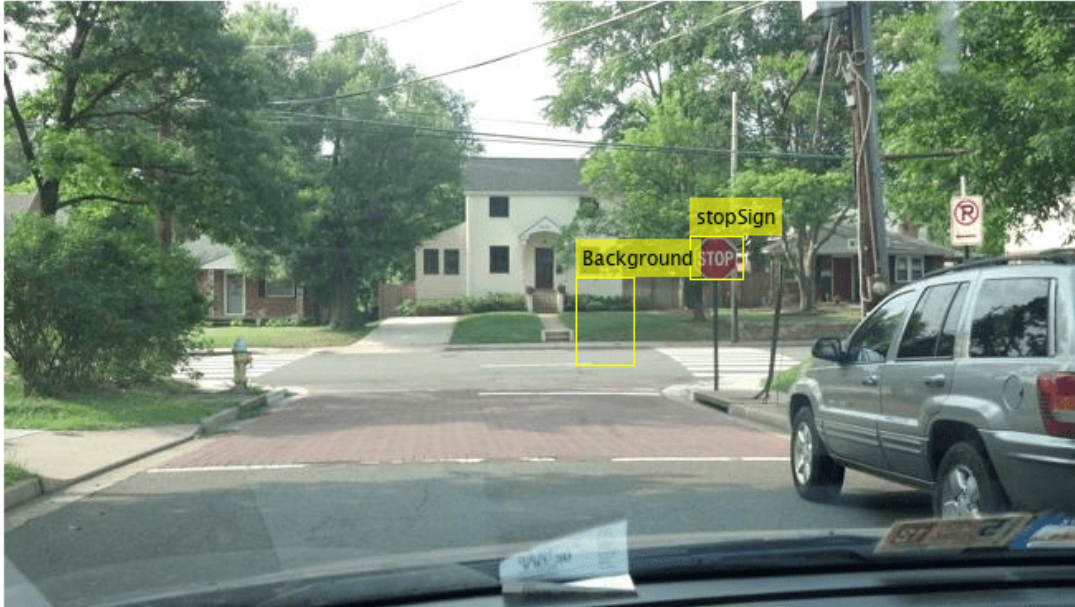
Input Arguments

detector — Fast R-CNN object detector

`fastRCNNObjectDetector` object

Fast R-CNN object detector, specified as a `fastRCNNObjectDetector` object. To create this object, call the `trainFastRCNNObjectDetector` function with training data as input.

I — Input image

grayscale image | RGB image

Input image, specified as a real, nonsparse, grayscale or RGB image.

Data Types: `uint8` | `uint16` | `int16` | `double` | `single` | `logical`

rois — Regions of interest

M -by-4 matrix

Regions of interest within the image, specified as an M -by-4 matrix defining M rectangular regions. Each row contains a four-element vector of the form $[x \ y \ width \ height]$. This vector specifies the upper left corner and size of a region in pixels.

resource — Hardware resource

'auto' (default) | 'gpu' | 'cpu'

Hardware resource used to classify image regions, specified as 'auto', 'gpu', or 'cpu'.

- 'auto' — Use a GPU if it is available. Otherwise, use the CPU.
- 'gpu' — Use the GPU. To use a GPU, you must have Parallel Computing Toolbox and a CUDA enabled NVIDIA GPU. If a suitable GPU is not available, the function returns an error. For information about the supported compute capabilities, see “GPU Support by Release” (Parallel Computing Toolbox).
- 'cpu' — Use the CPU.

Example: 'ExecutionEnvironment', 'cpu'

Output Arguments

labels — Classification labels of regions

M-by-1 categorical array

Classification labels of regions, returned as an *M*-by-1 categorical array. *M* is the number of regions of interest in `rois`. Each class name in `labels` corresponds to a classification score in `scores` and a region of interest in `rois`. `classifyRegions` obtains the class names from the input detector.

scores — Highest classification score per region

M-by-1 vector of values in the range [0, 1]

Highest classification score per region, returned as an *M*-by-1 vector of values in the range [0, 1]. *M* is the number of regions of interest in `rois`. Each classification score in `scores` corresponds to a class name in `labels` and a region of interest in `rois`. A higher score indicates higher confidence in the classification.

allScores — All classification scores per region

M-by-*N* matrix of values in the range [0, 1]

All classification scores per region, returned as an *M*-by-*N* matrix of values in the range [0, 1]. *M* is the number of regions in `rois`. *N* is the number of class names stored in the input detector. Each row of classification scores in `allScores` corresponds to a region of interest in `rois`. A higher score indicates higher confidence in the classification.

See Also

Apps

Image Labeler | **Video Labeler**

Functions

`trainFastRCNNObjectDetector`

Objects

`fastRCNNObjectDetector`

Introduced in R2017a

trainFastRCNNObjectDetector

Train a Fast R-CNN deep learning object detector

Syntax

```
trainedDetector = trainFastRCNNObjectDetector(trainingData, network, options)
[trainedDetector, info] = trainFastRCNNObjectDetector( ___ )
```

```
trainedDetector = trainFastRCNNObjectDetector(trainingData, checkpoint,
options)
```

```
trainedDetector = trainFastRCNNObjectDetector(trainingData, detector, options)
```

```
trainedDetector = trainFastRCNNObjectDetector( ___, 'RegionProposalFcn',
proposalFcn)
```

```
trainedDetector = trainFastRCNNObjectDetector( ___, Name, Value)
```

Description

Train a Detector

```
trainedDetector = trainFastRCNNObjectDetector(trainingData, network, options)
```

trains a Fast R-CNN (regions with convolution neural networks) object detector using deep learning. You can train a Fast R-CNN detector to detect multiple object classes.

This function requires that you have Deep Learning Toolbox. It is recommended that you also have Parallel Computing Toolbox to use with a CUDA-enabled NVIDIA GPU. For information about the supported compute capabilities, see “GPU Support by Release” (Parallel Computing Toolbox).

`[trainedDetector, info] = trainFastRCNNObjectDetector(___)` also returns information on the training progress, such as training loss and accuracy, for each iteration.

Resume Training a Detector

```
trainedDetector = trainFastRCNNObjectDetector(trainingData, checkpoint,
options)
```

resumes training from a detector checkpoint.

Fine Tune a Detector

```
trainedDetector = trainFastRCNNObjectDetector(trainingData, detector, options)
```

continues training a detector with additional training data or performs more training iterations to improve detector accuracy.

Custom Region Proposal

```
trainedDetector = trainFastRCNNObjectDetector( ___, 'RegionProposalFcn',
proposalFcn)
```

optionally trains a custom region proposal function, `proposalFcn`, using any of the previous inputs. If you do not specify a proposal function, then the function uses a variation of the Edge Boxes[2] algorithm.

Additional Properties

`trainedDetector = trainFastRCNNObjectDetector(___, Name, Value)` uses additional options specified by one or more `Name, Value` pair arguments.

Examples

Train Fast R-CNN Stop Sign Detector

Load training data.

```
data = load('rcnnStopSigns.mat', 'stopSigns', 'fastRCNNLayers');
stopSigns = data.stopSigns;
fastRCNNLayers = data.fastRCNNLayers;
```

Add fullpath to image files.

```
stopSigns.imageFilename = fullfile(toolboxdir('vision'),'visiondata', ...
    stopSigns.imageFilename);
```

Randomly shuffle data for training.

```
rng(0);
shuffledIdx = randperm(height(stopSigns));
stopSigns = stopSigns(shuffledIdx,:);
```

Create an `imageDatastore` using the files from the table.

```
imds = imageDatastore(stopSigns.imageFilename);
```

Create a `boxLabelDatastore` using the label columns from the table.

```
blds = boxLabelDatastore(stopSigns(:,2:end));
```

Combine the datastores.

```
ds = combine(imds, blds);
```

The stop sign training images have different sizes. Preprocess the data to resize the image and boxes to a predefined size.

```
ds = transform(ds,@(data)preprocessData(data,[920 968 3]));
```

Set the network training options.

```
options = trainingOptions('sgdm', ...
    'MiniBatchSize', 10, ...
    'InitialLearnRate', 1e-3, ...
    'MaxEpochs', 10, ...
    'CheckpointPath', tempdir);
```

Train the Fast R-CNN detector. Training can take a few minutes to complete.

```
frcn = trainFastRCNNObjectDetector(ds, fastRCNNLayers, options, ...
    'NegativeOverlapRange', [0 0.1], ...
    'PositiveOverlapRange', [0.7 1]);
```

```
*****
Training a Fast R-CNN Object Detector for the following object classes:
```

```
* stopSign
```

```
--> Extracting region proposals from training datastore...done.
```

```
Training on single GPU.
```

Epoch	Iteration	Time Elapsed (hh:mm:ss)	Mini-batch Loss	Mini-batch Accuracy	Mini-batch RMSE	Base Le Rate
1	1	00:00:29	0.3787	93.59%	0.96	
10	10	00:05:14	0.3032	98.52%	0.95	

```
Detector training complete.
```

```
*****
```

```
Test the Fast R-CNN detector on a test image.
```

```
img = imread('stopSignTest.jpg');
```

```
Run the detector.
```

```
[bbox, score, label] = detect(frcnn, img);
```

```
Display detection results.
```

```
detectedImg = insertObjectAnnotation(img, 'rectangle', bbox, score);
figure
imshow(detectedImg)
```



Supporting Functions

```
function data = preprocessData(data,targetSize)
% Resize image and bounding boxes to the targetSize.
scale = targetSize(1:2)./size(data{1},[1 2]);
data{1} = imresize(data{1},targetSize(1:2));
bboxes = round(data{2});
data{2} = bboxresize(bboxes,scale);
end
```

Input Arguments

trainingData — Labeled ground truth

datastore | table

Labeled ground truth, specified as a datastore or a table.

Each bounding box must be in the format $[x\ y\ width\ height]$.

- If you use a datastore, your data must be set up so that calling the datastore with the `read` and `readall` functions returns a cell array or table with two or three columns. When the output contains two columns, the first column must contain bounding boxes, and the second column must contain labels, $\{boxes, labels\}$. When the output contains three columns, the second column must contain the bounding boxes, and the third column must contain the labels. In this case, the first column can contain any type of data. For example, the first column can contain images or point cloud data.

data	boxes	labels
The first column can contain data, such as point cloud data or images.	The second column must be a cell array that contains M -by-5 matrices of bounding boxes of the form $[x_{center}, y_{center}, width, height, yaw]$. The vectors represent the location and size of bounding boxes for the objects in each image. If the bounding box is axis-aligned, then you do not need to specify the yaw. Therefore, the bounding box would be described as an M -by-4 matrices of bounding boxes of the form $[x_{center}, y_{center}, width, height]$.	The third column must be a cell array that contains M -by-1 categorical vectors containing object class names. All categorical data returned by the datastore must contain the same categories.

For more information, see “Datastores for Deep Learning” (Deep Learning Toolbox).

- If you use a table, the table must have two or more columns. The first column of the table must contain image file names with paths. The images must be grayscale or truecolor (RGB) and they can be in any format supported by `imread`. Each of the remaining columns must be a cell vector that contains M -by-4 matrices that represent a single object class, such as *vehicle*, *flower*, or *stop sign*. The columns contain 4-element double arrays of M bounding boxes in the format

[*x,y,width,height*]. The format specifies the upper-left corner location and size of the bounding box in the corresponding image. To create a ground truth table, you can use the **Image Labeler** app or **Video Labeler** app. To create a table of training data from the generated ground truth, use the `objectDetectorTrainingData` function.

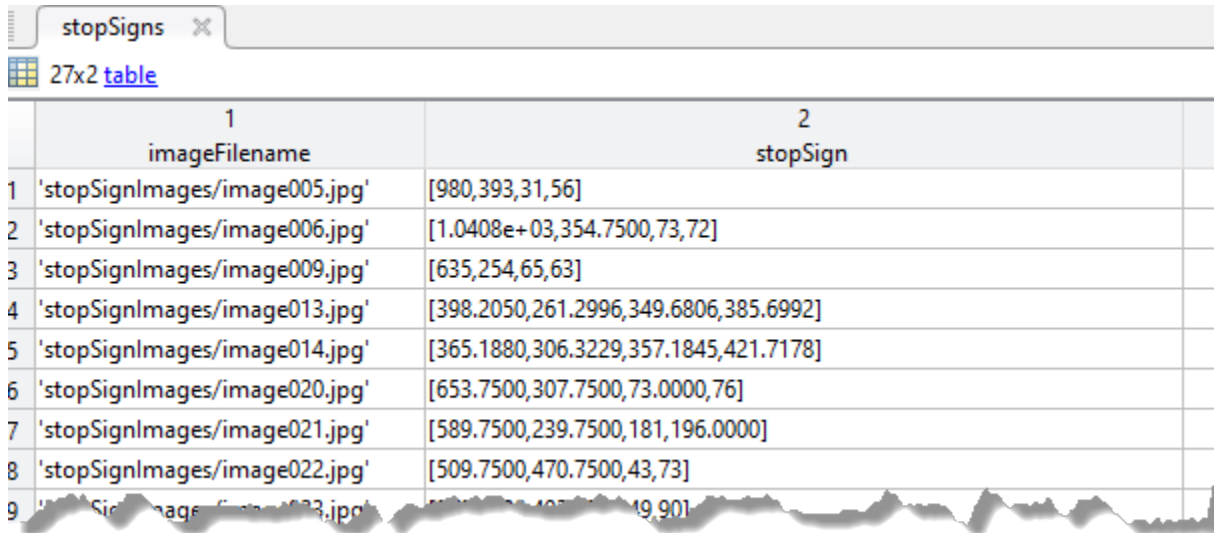

	1 imageFilename	2 stopSign
1	'stopSignImages/image005.jpg'	[980,393,31,56]
2	'stopSignImages/image006.jpg'	[1.0408e+03,354.7500,73,72]
3	'stopSignImages/image009.jpg'	[635,254,65,63]
4	'stopSignImages/image013.jpg'	[398.2050,261.2996,349.6806,385.6992]
5	'stopSignImages/image014.jpg'	[365.1880,306.3229,357.1845,421.7178]
6	'stopSignImages/image020.jpg'	[653.7500,307.7500,73.0000,76]
7	'stopSignImages/image021.jpg'	[589.7500,239.7500,181,196.0000]
8	'stopSignImages/image022.jpg'	[509.7500,470.7500,43,73]
9	'stopSignImages/image023.jpg'	[509.7500,470.7500,43,73]

network — Network

SeriesNetwork object | array of Layer objects | LayerGraph object | network name

Network, specified as a `SeriesNetwork`, an array of `Layer` objects, a `LayerGraph` object, or by the network name. The network is trained to classify the object classes defined in the `trainingData` table. The `SeriesNetwork`, `Layer`, and `layerGraph` objects are available in the Deep Learning Toolbox.

- When you specify the network as a `SeriesNetwork`, an array of `Layer` objects, or by the network name, the network is automatically transformed into a Fast R-CNN network by adding an ROI max pooling layer, and new classification and regression layers to support object detection. Additionally, the `GridSize` property of the ROI max pooling layer is set to the output size of the last max pooling layer in the network.
- The array of `Layer` objects must contain a classification layer that supports the number of object classes, plus a background class. Use this input type to customize the learning rates of each layer. An example of an array of `Layer` objects:

```
layers = [imageInputLayer([28 28 3])
          convolution2dLayer([5 5],10)
          reluLayer()
          fullyConnectedLayer(10)
          softmaxLayer()
          classificationLayer()];
```

- When you specify the network as `SeriesNetwork`, `Layer` array, or network by name, the weights for additional convolution and fully-connected layers that you add to create the network, are initialized to 'narrow-normal'.
- The network name must be one of the following valid network names. You must also install the corresponding Add-on.

Network Name	Feature Extraction Layer Name	ROI Pooling Layer OutputSize	Description
alexnet	'relu5'	[6 6]	Last max pooling layer is replaced by ROI max pooling layer
vgg16	'relu5_3'	[7 7]	
vgg19	'relu5_4'		
squeezenet	'fire5-concat'	[14 14]	ROI pooling layer is inserted after the feature extraction layer.
resnet18	'res4b_relu'		
resnet50	'activation_40_relu'		
resnet101	'res4b22_relu'		
googlenet	'inception_4d-output'		
mobilenetv2	'block_13_expand_relu'		
inceptionv3	'mixed7'	[17 17]	
inceptionresnetv2	'block17_20_ac'		

- The LayerGraph object must be a valid Fast R-CNN object detection network. You can also use a LayerGraph object to train a custom Fast R-CNN network.

Tip If your network is a DAGNetwork, use the layerGraph function to convert the network to a LayerGraph object. Then, create a custom Fast R-CNN network as described by the “Create Fast R-CNN Object Detection Network” example.

See “Getting Started with R-CNN, Fast R-CNN, and Faster R-CNN” to learn more about how to create a Fast R-CNN network.

options — Training options

trainingOptions output

Training options, returned by the trainingOptions function from the Deep Learning Toolbox. To specify solver and other options for network training, use trainingOptions.

Note trainFastRCNNObjectDetector does not support these training options:

- The trainingOptions 'once' and 'every-epoch' Shuffle options are not supported for combined datastore inputs.
 - The trainingOptions 'parallel' and 'multi-gpu' ExecutionEnvironment options are not supported when you use a combined datastore input.
 - Datastore inputs are not supported when you set the DispatchInBackground training option to true.
-

checkpoint — Saved detector checkpoint

fastRCNNObjectDetector object

Saved detector checkpoint, specified as a fastRCNNObjectDetector object. To save the detector after every epoch, set the 'CheckpointPath' property when using the trainingOptions function. Saving a checkpoint after every epoch is recommended because network training can take a few hours.

To load a checkpoint for a previously trained detector, load the MAT-file from the checkpoint path. For example, if the 'CheckpointPath' property of options is '/tmp', load a checkpoint MAT-file using:

```
data = load('/tmp/faster_rcnn_checkpoint__105__2016_11_18__14_25_08.mat');
```

The name of the MAT-file includes the iteration number and timestamp of when the detector checkpoint was saved. The detector is saved in the detector variable of the file. Pass this file back into the trainFastRCNNObjectDetector function:

```
frcnn = trainFastRCNNObjectDetector(stopSigns,...
    data.detector,options);
```

detector — Previously trained Fast R-CNN object detector

fastRCNNObjectDetector object

Previously trained Fast R-CNN object detector, specified as a fastRCNNObjectDetector object.

proposalFcn — Region proposal method

function handle

Region proposal method, specified as a function handle. If you do not specify a region proposal function, the function implements a variant of the EdgeBoxes[2] algorithm. The function must have the form:

```
[bboxes,scores] = proposalFcn(I)
```

The input, I, is an image defined in the trainingData table. The function must return rectangular bound boxes, bboxes, in an *m*-by-4 array. Each row of bboxes contains a four-element vector, [x,y,width,height]. This vector specifies the upper-left corner and size of a bounding box in pixels. The function must also return a score for each bounding box in an *m*-by-1 vector. Higher score values indicate that the bounding box is more likely to contain an object. The scores are used to select the strongest *n* regions, where *n* is defined by the value of NumStrongestRegions.

Dependencies

If you do not specify a custom proposal function and you use a table for the input training data, the function uses a variation of the Edge Boxes algorithm. If you use a datastore for input training data for multichannel images, you must specify a custom region proposal function.

Name-Value Pair Arguments

Specify optional comma-separated pairs of Name, Value arguments. Name is the argument name and Value is the corresponding value. Name must appear inside quotes. You can specify several name and value pair arguments in any order as Name1, Value1, ..., NameN, ValueN.

Example: 'PositiveOverlapRange',[0.75 1]

PositiveOverlapRange — Bounding box overlap ratios for positive training samples

[0.5 1] (default) | two-element vector

Bounding box overlap ratios for positive training samples, specified as the comma-separated pair consisting of 'PositiveOverlapRange' and a two-element vector. The vector contains values in the range [0,1]. Region proposals that overlap with ground truth bounding boxes within the specified range are used as positive training samples.

The overlap ratio used for both the PositiveOverlapRange and NegativeOverlapRange is defined as:

$$\frac{\text{area}(A \cap B)}{\text{area}(A \cup B)}$$

A and B are bounding boxes.

NegativeOverlapRange — Bounding box overlap ratios for negative training samples

[0.1 0.5] (default) | two-element vector

Bounding box overlap ratios for negative training samples, specified as the comma-separated pair consisting of NegativeOverlapRange and a two-element vector. The vector contains values in the range [0,1]. Region proposals that overlap with the ground truth bounding boxes within the specified range are used as negative training samples.

The overlap ratio used for both the PositiveOverlapRange and NegativeOverlapRange is defined as:

$$\frac{\text{area}(A \cap B)}{\text{area}(A \cup B)}$$

A and B are bounding boxes.

NumStrongestRegions — Maximum number of strongest region proposals

2000 (default) | positive integer

Maximum number of strongest region proposals to use for generating training samples, specified as the comma-separated pair consisting of 'NumStrongestRegions' and a positive integer. Reduce this value to speed up processing time at the cost of training accuracy. To use all region proposals, set this value to Inf.

NumRegionsToSample — Number of region proposals

128 (default) | integer

Number of region proposals to randomly sample from each training image, specified by an integer. Reduce the number of regions to sample to reduce memory usage and speed-up training. Reducing the value can also decrease training accuracy.

SmallestImageDimension — Length of smallest image dimension

[] (default) | positive integer

Length of smallest image dimension, either width or height, specified as the comma-separated pair consisting of 'SmallestImageDimension' and a positive integer. Training images are resized such that the length of the shortest dimension is equal to the specified integer. By default, training images are not resized. Resizing training images helps reduce computational costs and memory used when training images are large. Typical values range from 400–600 pixels.

Dependencies

- The `SmallestImageDimension` property only supports table input training data. To resize the input data of a datastore input, use the `transform` function.

FreezeBatchNormalization — Frozen batch normalization

`true` (default) | `false`

Frozen batch normalization during training, specified as the comma-separated pair consisting of 'FreezeBatchNormalization' and `true` or `false`. The value indicates whether the input layers to the network are frozen during training. Set this value to `true` if you are training with a small mini-batch size. Small batch sizes result in poor estimates of the batch mean and variance that is required for effective batch normalization.

If you do not specify a value for 'FreezeBatchNormalization', the function sets the property to

- `true` if the 'MiniBatchSize' name-value argument for the `trainingOptions` function is less than 8.
- `false` if the 'MiniBatchSize' name-value argument for the `trainingOptions` function is greater than or equal to 8.

You must specify a value for 'FreezeBatchNormalization' to override this default behavior.

ExperimentManager — Detector training experiment monitoring

'none' (default) | `experiments.Monitor` object

Detector training experiment monitoring, specified as an `experiments.Monitor` object for use with the **Experiment Manager** app. You can use this object to track the progress of training, update information fields in the training results table, record values of the metrics used by the training, and to produce training plots.

Information monitored during training:

- Training loss at each iteration.
- Training accuracy at each iteration.
- Training root mean square error (RMSE) for the box regression layer.
- Learning rate at each iteration.

Output Arguments

trainedDetector — Trained Fast R-CNN object detector

`fastRCNNObjectDetector` object

Trained Fast R-CNN object detector, returned as a `fastRCNNObjectDetector` object.

info — Training progress information

structure array

Training progress information, returned as a structure array with eight fields. Each field corresponds to a stage of training.

- `TrainingLoss` — Training loss at each iteration is the mean squared error (MSE) calculated as the sum of localization error, confidence loss, and classification loss. For more information about the training loss function, see "Training Loss" on page 3-1028.

- **TrainingAccuracy** — Training set accuracy at each iteration.
- **TrainingRMSE** — Training root mean squared error (RMSE) is the RMSE calculated from the training loss at each iteration.
- **BaseLearnRate** — Learning rate at each iteration.
- **ValidationLoss** — Validation loss at each iteration.
- **ValidationAccuracy** — Validation accuracy at each iteration.
- **ValidationRMSE** — Validation RMSE at each iteration.
- **FinalValidationLoss** — Final validation loss at end of the training.
- **FinalValidationRMSE** — Final validation RMSE at end of the training.

Each field is a numeric vector with one element per training iteration. Values that have not been calculated at a specific iteration are assigned as NaN. The struct contains **ValidationLoss**, **ValidationAccuracy**, **ValidationRMSE**, **FinalValidationLoss**, and **FinalValidationRMSE** fields only when options specifies validation data.

Tips

- To accelerate data preprocessing for training, **trainFastRCNNObjectDetector** automatically creates and uses a parallel pool based on your parallel preference settings. For more details about setting these preferences, see parallel preference settings. Using parallel computing preferences requires Parallel Computing Toolbox.
- VGG-16, VGG-19, ResNet-101, and Inception-ResNet-v2 are large models. Training with large images can produce "Out of Memory" errors. To mitigate these errors, try one or more of these options:
 - Reduce the size of your images by using the '**SmallestImageDimension**' argument.
 - Decrease the value of the '**NumRegionsToSample**' name-value argument value.
- This function supports transfer learning. When you input a network by name, such as '**resnet50**', then the function automatically transforms the network into a valid Fast R-CNN network model based on the pretrained **resnet50** model. Alternatively, manually specify a custom Fast R-CNN network by using the **LayerGraph** extracted from a pretrained DAG network. For more details, see "Create Fast R-CNN Object Detection Network".
- This table describes how to transform each named network into a Fast R-CNN network. The feature extraction layer name specifies which layer is processed by the ROI pooling layer. The ROI output size specifies the size of the feature maps output by the ROI pooling layer.

Network Name	Feature Extraction Layer Name	ROI Pooling Layer OutputSize	Description
alexnet	'relu5'	[6 6]	Last max pooling layer is replaced by ROI max pooling layer
vgg16	'relu5_3'	[7 7]	
vgg19	'relu5_4'		
squeezenet	'fire5-concat'	[14 14]	ROI pooling layer is inserted after the feature extraction layer.
resnet18	'res4b_relu'		

Network Name	Feature Extraction Layer Name	ROI Pooling Layer OutputSize	Description
resnet50	'activation_40_relu'		
resnet101	'res4b22_relu'		
googlenet	'inception_4d-output'		
mobilenetv2	'block_13_expand_relu'		
inceptionv3	'mixed7'	[17 17]	
inceptionresnetv2	'block17_20_ac'		

To modify and transform a network into a Fast R-CNN network, see “Design an R-CNN, Fast R-CNN, and a Faster R-CNN Model”.

- Use the `trainingOptions` function to enable or disable verbose printing.

References

- [1] Girshick, Ross. "Fast R-CNN." *Proceedings of the IEEE International Conference on Computer Vision*. 2015.
- [2] Zitnick, C. Lawrence, and Piotr Dollar. "Edge Boxes: Locating Object Proposals From Edges." *Computer Vision-ECCV 2014*. Springer International Publishing, 2014, pp. 391-405.

Extended Capabilities

Automatic Parallel Support

Accelerate code by automatically running computation in parallel using Parallel Computing Toolbox™.

To run in parallel, set 'UseParallel' to true or enable this by default using the Computer Vision Toolbox preferences.

For more information, see “Parallel Computing Toolbox Support”.

See Also

Apps

Image Labeler | Video Labeler

Functions

objectDetectorTrainingData | trainRCNNObjectDetector | trainFasterRCNNObjectDetector | trainingOptions | estimateAnchorBoxes

Objects

Layer | SeriesNetwork | fastRCNNObjectDetector | boxLabelDatastore

Topics

“Anchor Boxes for Object Detection”

“Getting Started with R-CNN, Fast R-CNN, and Faster R-CNN”

“Datastores for Deep Learning” (Deep Learning Toolbox)

Introduced in R2017a

peopleDetectorACF

Detect people using aggregate channel features

Syntax

```
detector = peopleDetectorACF  
detector = peopleDetectorACF(name)
```

Description

`detector = peopleDetectorACF` returns a pretrained upright people detector using aggregate channel features (ACF). The detector is an `acfObjectDetector` object, and is trained using the INRIA person data set.

`detector = peopleDetectorACF(name)` returns a pretrained upright people detector based on the specified model name.

Examples

Detect People Using Aggregated Channel Features

Load the upright people detector.

```
detector = peopleDetectorACF;
```

Read an image. Detect people in the image.

```
I = imread('visionteam1.jpg');  
[bboxes,scores] = detect(detector,I);
```

Annotate detected people with bounding boxes and their detection scores.

```
I = insertObjectAnnotation(I,'rectangle',bboxes,scores);  
figure  
imshow(I)  
title('Detected People and Detection Scores')
```

Detected People and Detection Scores

Input Arguments

name — ACF classification model

'inria-100x41' (default) | 'caltech-50x21'

ACF classification model, specified as 'inria-100x41' or 'caltech-50x21'. The 'inria-100x41' model was trained using the INRIA Person data set. The 'caltech-50x21' model was trained using the Caltech Pedestrian data set.

Output Arguments

detector — Trained ACF-based object detector

acfObjectDetector object

Trained ACF-based object detector, returned as an acfObjectDetector object. The detector is trained to detect upright people in an image.

References

- [1] Dollar, P., R. Appel, S. Belongie, and P. Perona. "Fast Feature Pyramids for Object Detection." *IEEE Transactions on Pattern Analysis and Machine Intelligence*. Vol. 36, Issue 8, 2014, pp. 1532-1545.
- [2] Dollar P., C. Wojek, B. Shiele, and P. Perona. "Pedestrian Detection: An Evaluation of the State of the Art." *IEEE Transactions on Pattern Analysis and Machine Intelligence*. Vol. 34, Issue 4, 2012, pp. 743-761.
- [3] Dollar, P., C., Wojek, B. Shiele, and P. Perona. "Pedestrian Detection: A Benchmark." *IEEE Conference on Computer Vision and Pattern Recognition*. 2009.

See Also

`acfObjectDetector` | `detect` | `trainACFObjectDetector` | `vision.PeopleDetector` | `vision.CascadeObjectDetector` | `selectStrongestBbox`

Topics

"Tracking Pedestrians from a Moving Car"
"Point Feature Types"

Introduced in R2017a

objectDetectorTrainingData

Create training data for an object detector

Syntax

```
[imds,blds] = objectDetectorTrainingData(gTruth)
trainingDataTable = objectDetectorTrainingData(gTruth)
___ = objectDetectorTrainingData(gTruth,Name,Value)
```

Description

`[imds,blds] = objectDetectorTrainingData(gTruth)` creates an image datastore and a box label datastore training data from the specified ground truth.

You can combine the image and box label datastores using `combine(imds,blds)` to create a datastore needed for training. Use the combined datastore with the training functions, such as `trainACFObjectDetector`, `trainYOLOv2ObjectDetector`, `trainFastRCNNObjectDetector`, `trainFasterRCNNObjectDetector`, and `trainRCNNObjectDetector`.

This function supports parallel computing using multiple MATLAB workers. Enable parallel computing using the “Computer Vision Toolbox Preferences” dialog.

`trainingDataTable = objectDetectorTrainingData(gTruth)` returns a table of training data from the specified ground truth. `gTruth` is an array of `groundTruth` objects. You can use the table to train an object detector using the Computer Vision Toolbox training functions.

`___ = objectDetectorTrainingData(gTruth,Name,Value)` returns a table of training data with additional options specified by one or more name-value pair arguments. If you create the `groundTruth` objects in `gTruth` using a video file, a custom data source, or an `imageDatastore` object with different custom read functions, then you can specify any combination of name-value pair arguments. If you create the `groundTruth` objects from an image collection or image sequence data source, then you can specify only the 'SamplingFactor' name-value pair argument.

Examples

Train a YOLO v2 Vehicle Detector

Train a vehicle detector based on a YOLO v2 network.

Add the folder containing images to the workspace.

```
imageDir = fullfile(matlabroot,'toolbox','vision','visiondata','vehicles');
addpath(imageDir);
```

Load the vehicle ground truth data.

```
data = load('vehicleTrainingGroundTruth.mat');
gTruth = data.vehicleTrainingGroundTruth;
```

Load the detector containing the `layerGraph` object for training.

```
vehicleDetector = load('yolov2VehicleDetector.mat');
lgraph = vehicleDetector.lgraph
```

```
lgraph =
  LayerGraph with properties:

      Layers: [25x1 nnet.cnn.layer.Layer]
  Connections: [24x2 table]
   InputNames: {'input'}
  OutputNames: {'yolov2OutputLayer'}
```

Create an image datastore and box label datastore using the ground truth object.

```
[imds,bxds] = objectDetectorTrainingData(gTruth);
```

Combine the datastores.

```
cds = combine(imds,bxds);
```

Configure training options.

```
options = trainingOptions('sgdm', ...
    'InitialLearnRate', 0.001, ...
    'Verbose',true, ...
    'MiniBatchSize',16, ...
    'MaxEpochs',30, ...
    'Shuffle','every-epoch', ...
    'VerboseFrequency',10);
```

Train the detector.

```
[detector,info] = trainYOLOv2ObjectDetector(cds,lgraph,options);
```

```
*****
```

```
Training a YOLO v2 Object Detector for the following object classes:
```

```
* vehicle
```

```
Training on single CPU.
```

Epoch	Iteration	Time Elapsed (hh:mm:ss)	Mini-batch RMSE	Mini-batch Loss	Base Learning Rate
1	1	00:00:00	7.50	56.2	0.0010
1	10	00:00:02	1.73	3.0	0.0010
2	20	00:00:04	1.58	2.5	0.0010
2	30	00:00:06	1.36	1.9	0.0010
3	40	00:00:08	1.13	1.3	0.0010
3	50	00:00:09	1.01	1.0	0.0010
4	60	00:00:11	0.95	0.9	0.0010
4	70	00:00:13	0.84	0.7	0.0010
5	80	00:00:15	0.84	0.7	0.0010
5	90	00:00:17	0.70	0.5	0.0010
6	100	00:00:19	0.65	0.4	0.0010
7	110	00:00:21	0.73	0.5	0.0010
7	120	00:00:23	0.60	0.4	0.0010
8	130	00:00:24	0.63	0.4	0.0010
8	140	00:00:26	0.64	0.4	0.0010

9	150	00:00:28	0.57	0.3	0.0010
9	160	00:00:30	0.54	0.3	0.0010
10	170	00:00:32	0.52	0.3	0.0010
10	180	00:00:33	0.45	0.2	0.0010
11	190	00:00:35	0.55	0.3	0.0010
12	200	00:00:37	0.56	0.3	0.0010
12	210	00:00:39	0.55	0.3	0.0010
13	220	00:00:41	0.52	0.3	0.0010
13	230	00:00:42	0.53	0.3	0.0010
14	240	00:00:44	0.58	0.3	0.0010
14	250	00:00:46	0.47	0.2	0.0010
15	260	00:00:48	0.49	0.2	0.0010
15	270	00:00:50	0.44	0.2	0.0010
16	280	00:00:52	0.45	0.2	0.0010
17	290	00:00:54	0.47	0.2	0.0010
17	300	00:00:55	0.43	0.2	0.0010
18	310	00:00:57	0.44	0.2	0.0010
18	320	00:00:59	0.44	0.2	0.0010
19	330	00:01:01	0.38	0.1	0.0010
19	340	00:01:03	0.41	0.2	0.0010
20	350	00:01:04	0.39	0.2	0.0010
20	360	00:01:06	0.42	0.2	0.0010
21	370	00:01:08	0.42	0.2	0.0010
22	380	00:01:10	0.39	0.2	0.0010
22	390	00:01:12	0.37	0.1	0.0010
23	400	00:01:13	0.37	0.1	0.0010
23	410	00:01:15	0.35	0.1	0.0010
24	420	00:01:17	0.29	8.3e-02	0.0010
24	430	00:01:19	0.36	0.1	0.0010
25	440	00:01:21	0.28	7.9e-02	0.0010
25	450	00:01:22	0.29	8.1e-02	0.0010
26	460	00:01:24	0.28	8.0e-02	0.0010
27	470	00:01:26	0.27	7.1e-02	0.0010
27	480	00:01:28	0.25	6.3e-02	0.0010
28	490	00:01:30	0.24	5.9e-02	0.0010
28	500	00:01:31	0.29	8.4e-02	0.0010
29	510	00:01:33	0.35	0.1	0.0010
29	520	00:01:35	0.31	9.3e-02	0.0010
30	530	00:01:37	0.18	3.1e-02	0.0010
30	540	00:01:38	0.22	4.6e-02	0.0010

Detector training complete.

Read a test image.

```
I = imread('detectcars.png');
```

Run the detector.

```
[bboxes,scores] = detect(detector,I);
```

Display the results.

```
if(~isempty(bboxes))
    I = insertObjectAnnotation(I,'rectangle',bboxes,scores);
end
figure
imshow(I)
```

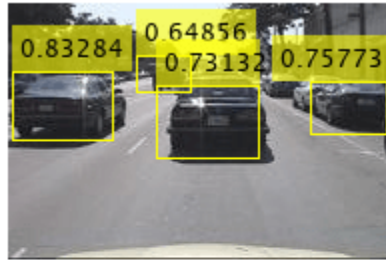

Train ACF-Based Stop Sign Detector

Use training data to train an ACF-based object detector for stop signs

Add the folder containing images to the MATLAB path.

```
imageDir = fullfile(matlabroot, 'toolbox', 'vision', 'visiondata', 'stopSignImages');
addpath(imageDir);
```

Load ground truth data, which contains data for stops signs and cars.

```
load('stopSignsAndCarsGroundTruth.mat', 'stopSignsAndCarsGroundTruth')
```

View the label definitions to see the label types in the ground truth.

```
stopSignsAndCarsGroundTruth.LabelDefinitions
```

```
ans=3x3 table
      Name          Type          Group
-----
{'stopSign'}      Rectangle  {'None'}
{'carRear'}       Rectangle  {'None'}
{'carFront'}      Rectangle  {'None'}
```

Select the stop sign data for training.

```
stopSignGroundTruth = selectLabelsByName(stopSignsAndCarsGroundTruth, 'stopSign');
```

Create the training data for a stop sign object detector.

```
trainingData = objectDetectorTrainingData(stopSignGroundTruth);
summary(trainingData)
```

Variables:

```
imageFilename: 41x1 cell array of character vectors
```

```
stopSign: 41x1 cell
```

Train an ACF-based object detector.

```
acfDetector = trainACFObjectDetector(trainingData, 'NegativeSamplesFactor', 2);
```

```
ACF Object Detector Training
The training will take 4 stages. The model size is 34x31.
Sample positive examples(~100% Completed)
Compute approximation coefficients...Completed.
Compute aggregated channel features...Completed.
-----
Stage 1:
Sample negative examples(~100% Completed)
Compute aggregated channel features...Completed.
Train classifier with 42 positive examples and 84 negative examples...Completed.
The trained classifier has 19 weak learners.
-----
Stage 2:
Sample negative examples(~100% Completed)
Found 84 new negative examples for training.
Compute aggregated channel features...Completed.
Train classifier with 42 positive examples and 84 negative examples...Completed.
The trained classifier has 20 weak learners.
-----
Stage 3:
Sample negative examples(~100% Completed)
Found 84 new negative examples for training.
Compute aggregated channel features...Completed.
Train classifier with 42 positive examples and 84 negative examples...Completed.
The trained classifier has 54 weak learners.
-----
Stage 4:
Sample negative examples(~100% Completed)
Found 84 new negative examples for training.
Compute aggregated channel features...Completed.
Train classifier with 42 positive examples and 84 negative examples...Completed.
The trained classifier has 61 weak learners.
-----
ACF object detector training is completed. Elapsed time is 22.0359 seconds.
```

Test the ACF-based detector on a sample image.

```
I = imread('stopSignTest.jpg');
bboxes = detect(acfDetector, I);
```

Display the detected object.

```
annotation = acfDetector.ModelName;
I = insertObjectAnnotation(I, 'rectangle', bboxes, annotation);
```

```
figure
imshow(I)
```



Remove the image folder from the path.

```
rmpath(imageDir);
```

Train ACF-Based Vehicle Detector

Use training data to train an ACF-based object detector for vehicles.

```
imageDir = fullfile(matlabroot, 'toolbox', 'driving', 'drivingdata', 'vehiclesSequence');
addpath(imageDir);
```

Load the ground truth data.

```
load vehicleGroundTruth.mat
```

Create the training data for an object detector for vehicles.

```
trainingData = objectDetectorTrainingData(gTruth, 'SamplingFactor', 2);
```

Train the ACF-based object detector.

```
acfDetector = trainACFObjectDetector(trainingData, 'ObjectTrainingSize', [20 20]);
```

ACF Object Detector Training

The training will take 4 stages. The model size is 20x20.

Sample positive examples (~100% Completed)

Compute approximation coefficients...Completed.

Compute aggregated channel features...Completed.

```
-----  
Stage 1:  
Sample negative examples(~100% Completed)  
Compute aggregated channel features...Completed.  
Train classifier with 71 positive examples and 355 negative examples...Completed.  
The trained classifier has 68 weak learners.  
-----  
Stage 2:  
Sample negative examples(~100% Completed)  
Found 76 new negative examples for training.  
Compute aggregated channel features...Completed.  
Train classifier with 71 positive examples and 355 negative examples...Completed.  
The trained classifier has 120 weak learners.  
-----  
Stage 3:  
Sample negative examples(~100% Completed)  
Found 54 new negative examples for training.  
Compute aggregated channel features...Completed.  
Train classifier with 71 positive examples and 355 negative examples...Completed.  
The trained classifier has 170 weak learners.  
-----  
Stage 4:  
Sample negative examples(~100% Completed)  
Found 63 new negative examples for training.  
Compute aggregated channel features...Completed.  
Train classifier with 71 positive examples and 355 negative examples...Completed.  
The trained classifier has 215 weak learners.  
-----  
ACF object detector training is completed. Elapsed time is 9.7977 seconds.
```

Test the ACF detector on a test image.

```
I = imread('highway.png');  
[bboxes, scores] = detect(acfDetector,I,'Threshold',1);
```

Select the detection with the highest classification score.

```
[~,idx] = max(scores);
```

Display the detected object.

```
annotation = acfDetector.ModelName;  
I = insertObjectAnnotation(I,'rectangle',bboxes(idx,:),annotation);
```

```
figure  
imshow(I)
```

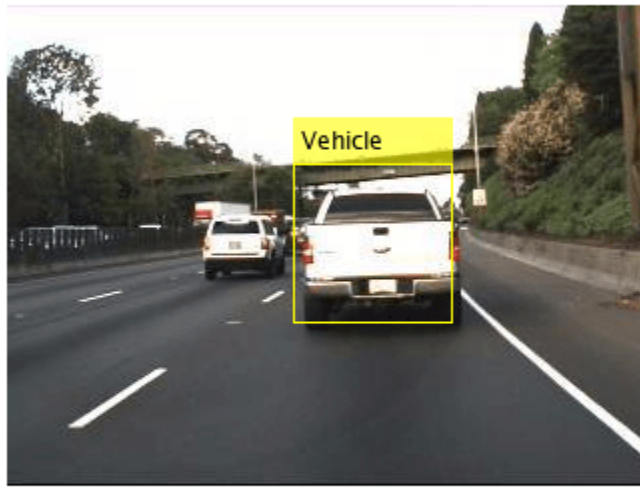
Remove the image folder from the path.

```
rmpath(imageDir);
```

Input Arguments

gTruth — Ground truth data

scalar | array of groundTruth objects

Ground truth data, specified as a scalar or an array of `groundTruth` objects. You can create ground truth objects from existing ground truth data by using the `groundTruth` object.

If you use custom data sources in `groundTruth` with parallel computing enabled, then the reader function is expected to work with a pool of MATLAB workers to read images from the data source in parallel.

Name-Value Pair Arguments

Specify optional comma-separated pairs of `Name`, `Value` arguments. `Name` is the argument name and `Value` is the corresponding value. `Name` must appear inside quotes. You can specify several name and value pair arguments in any order as `Name1, Value1, ..., NameN, ValueN`.

Example: `'SamplingFactor',5`

SamplingFactor — Factor for subsampling images

'auto' (default) | integer | vector of integers

Factor for subsampling images in the ground truth data source, specified as `'auto'`, an integer, or a vector of integers. For a sampling factor of N , the returned training data includes every N th image in the ground truth data source. The function ignores ground truth images with empty label data

Use sampled data to reduce repeated data, such as a sequence of images with the same scene and labels. It can also help in reducing training time.

Value	Sampling Factor
'auto'	The function samples data sources with timestamps, such as a video, with a factor of 5, and 1 for a collection of images.
Integer	Manually set the sampling factor to apply to all data.
Vector of integers	When you input an array of ground truth objects, the function uses the sampling factor specified by the corresponding vector element.

WriteLocation — Name of folder

pwd (current working folder) (default) | string scalar | character vector

Folder name to write extracted images to, specified as a string scalar or character vector. The specified folder must exist and have write permissions.

This argument applies only for:

- groundTruth objects created using a video file or a custom data source.
- An array of groundTruth objects created using imageDatastore , with different custom read functions.

The function ignores this argument when:

- The input groundTruth object was created from an image sequence data source.
- The array of input groundTruth objects all contain image datastores using the same custom read function.
- Any of the input groundTruth objects containing datastores, use the default read functions.

ImageFormat — Image file format

PNG (default) | string scalar | character vector

Image file format, specified as a string scalar or character vector. File formats must be supported by imwrite.

This argument applies only for:

- groundTruth objects created using a video file or a custom data source.
- An array of groundTruth objects created using imageDatastore with different custom read functions.

The function ignores this argument when:

- The input groundTruth object was created from an image sequence data source.
- The array of input groundTruth objects all contain image datastores using the same custom read function.
- Any of the input groundTruth objects containing datastores, use the default read functions.

NamePrefix — Prefix for output image file names

string scalar | character vector

Prefix for output image file names, specified as a string scalar or character vector. The image files are named as:

```
<name_prefix><source_number>_<image_number>.<image_format>
```

The default value uses the name of the data source that the images were extracted from, `strcat(sourceName, '_')`, for video and a custom data source, or `'datastore'`, for an image datastore.

This argument applies only for:

- `groundTruth` objects created using a video file or a custom data source.
- An array of `groundTruth` objects created using `imageDatastore` with different custom read functions.

The function ignores this argument when:

- The input `groundTruth` object was created from an image sequence data source.
- The array of input `groundTruth` objects all contain image datastores using the same custom read function.
- Any of the input `groundTruth` objects containing datastores, use the default read functions.

Verbose — Flag to display training progress

true (default) | false

Flag to display training progress at the MATLAB command line, specified as either `true` or `false`. This property applies only for `groundTruth` objects created using a video file or a custom data source.

Output Arguments**imds — Image datastore**

imageDatastore object

Image datastore, returned as an `imageDatastore` object containing images extracted from the `gTruth` objects. The images in `imds` contain at least one class of annotated labels. The function ignores images that are not annotated.

blds — Box label datastore

boxLabelDatastore object

Box label datastore, returned as a `boxLabelDatastore` object. The datastore contains categorical vectors for ROI label names and M -by-4 matrices of M bounding boxes. The locations and sizes of the bounding boxes are represented as double M -by-4 element vectors in the format `[x,y,width,height]`.

trainingDataTable — Training data table

table

Training data table, returned as a table with two or more columns. The first column of the table contains image file names with paths. The images can be grayscale or truecolor (RGB) and in any

format supported by `imread`. Each of the remaining columns correspond to an ROI label and contains the locations of bounding boxes in the image (specified in the first column), for that label. The bounding boxes are specified as M -by-4 matrices of M bounding boxes in the format `[x,y,width,height]`. `[x,y]` specifies the upper-left corner location. To create a ground truth table, you can use the **Image Labeler** app or **Video Labeler** app.

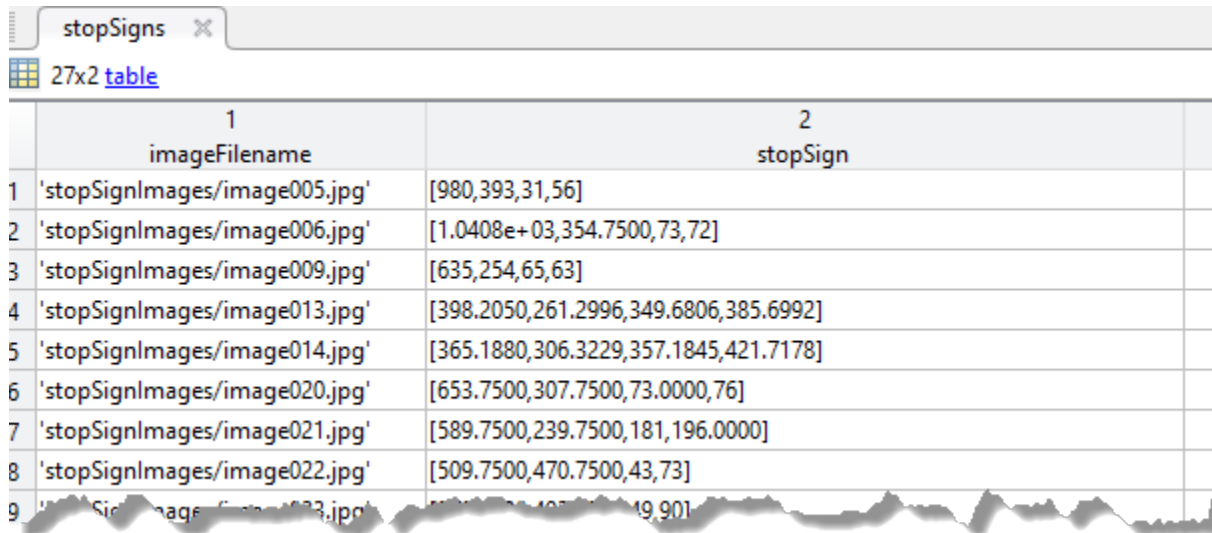

	1 imageFilename	2 stopSign
1	'stopSignImages/image005.jpg'	[980,393,31,56]
2	'stopSignImages/image006.jpg'	[1.0408e+03,354.7500,73,72]
3	'stopSignImages/image009.jpg'	[635,254,65,63]
4	'stopSignImages/image013.jpg'	[398.2050,261.2996,349.6806,385.6992]
5	'stopSignImages/image014.jpg'	[365.1880,306.3229,357.1845,421.7178]
6	'stopSignImages/image020.jpg'	[653.7500,307.7500,73.0000,76]
7	'stopSignImages/image021.jpg'	[589.7500,239.7500,181,196.0000]
8	'stopSignImages/image022.jpg'	[509.7500,470.7500,43,73]
9	'stopSignImages/image023.jpg'	[509.7500,470.7500,43,73]

The output table ignores any sublabel or attribute data present in the input `gTruth` object.

See Also

Apps

Image Labeler | **Video Labeler**

Functions

`trainFastRCNNObjectDetector` | `trainFasterRCNNObjectDetector` |
`trainRCNNObjectDetector` | `trainACFObjectDetector` | `trainYOLOv2ObjectDetector` |
`estimateAnchorBoxes`

Objects

`groundTruth` | `acfObjectDetector` | `imageDatastore` | `boxLabelDatastore`

Topics

“Datastores for Deep Learning” (Deep Learning Toolbox)

“Training Data for Object Detection and Semantic Segmentation”

Introduced in R2017a

estimateFisheyeParameters

Calibrate fisheye camera

Syntax

```
[fisheyeParams,imagesUsed,estimationErrors] = estimateFisheyeParameters(
imagePoints,worldPoints,imageSize)
[ ___ ] = estimateFisheyeParameters( ___ ,Name,Value)
```

Description

[fisheyeParams,imagesUsed,estimationErrors] = estimateFisheyeParameters(imagePoints,worldPoints,imageSize) returns a fisheyeParameters object containing estimates for the intrinsic and extrinsic parameters of a fisheye camera. The function also returns the images you used to estimate the fisheye parameters and the standard estimation errors for the single camera calibration.

[___] = estimateFisheyeParameters(___ ,Name,Value) configures the fisheyeParams object properties specified by one or more Name,Value pair arguments, using the previous syntax. Unspecified properties have their default values.

Examples

Fisheye Camera Calibration

Use calibration images to detect a checkerboard calibration pattern. Then calibrate the camera using corneres extracted from the pattern and visualize the results.

Gather a set of calibration images.

```
images = imageDatastore('calibImages');
imageFileNames = images.Files;
```

Detect the calibration pattern from the images. The 'PartialDetections' Name-Value argument is set to true by default allowing detection of partial checkerboards.

```
[imagePoints,boardSize] = detectCheckerboardPoints(imageFileNames, 'HighDistortion', true);
```

Generate world coordinates for the corners of the checkerboard squares.

```
squareSize = 20; % millimeters
worldPoints = generateCheckerboardPoints(boardSize,squareSize);
```

Estimate the fisheye camera calibration parameters based on the image and world points.

```
I = readimage(images,10);
imageSize = [size(I,1) size(I,2)];
params = estimateFisheyeParameters(imagePoints,worldPoints,imageSize);
```

Visualize the calibration accuracy.

```
figure  
showReprojectionErrors(params);
```

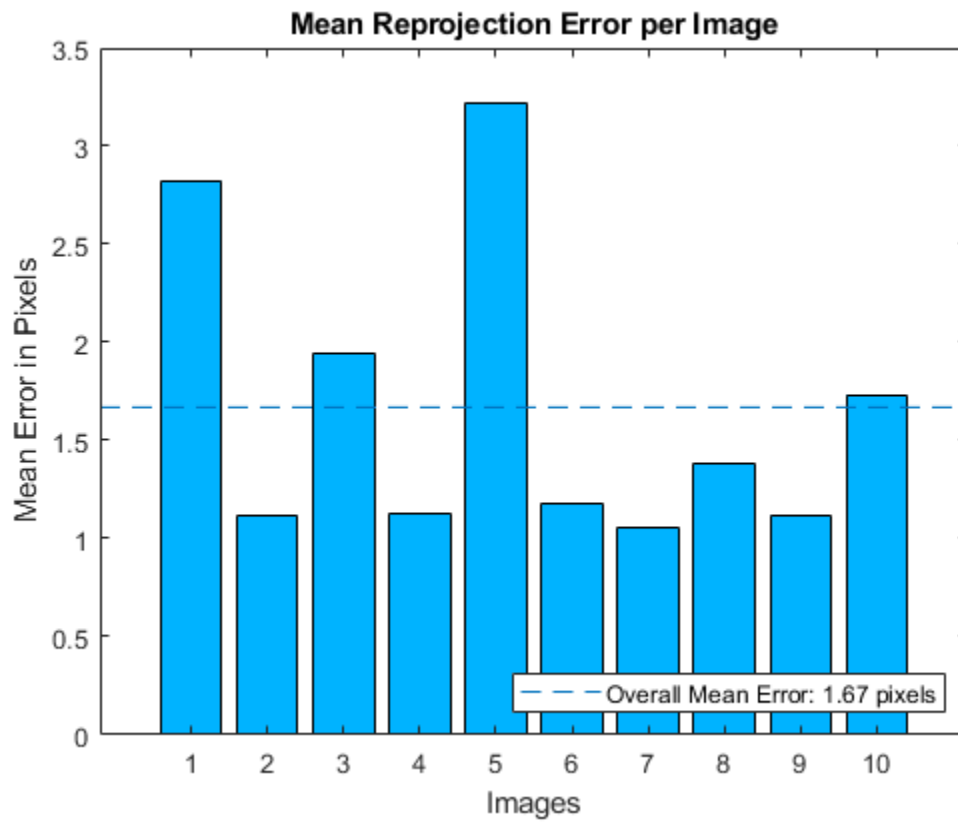

Visualize the camera extrinsics.

```
figure  
showExtrinsics(params);
```

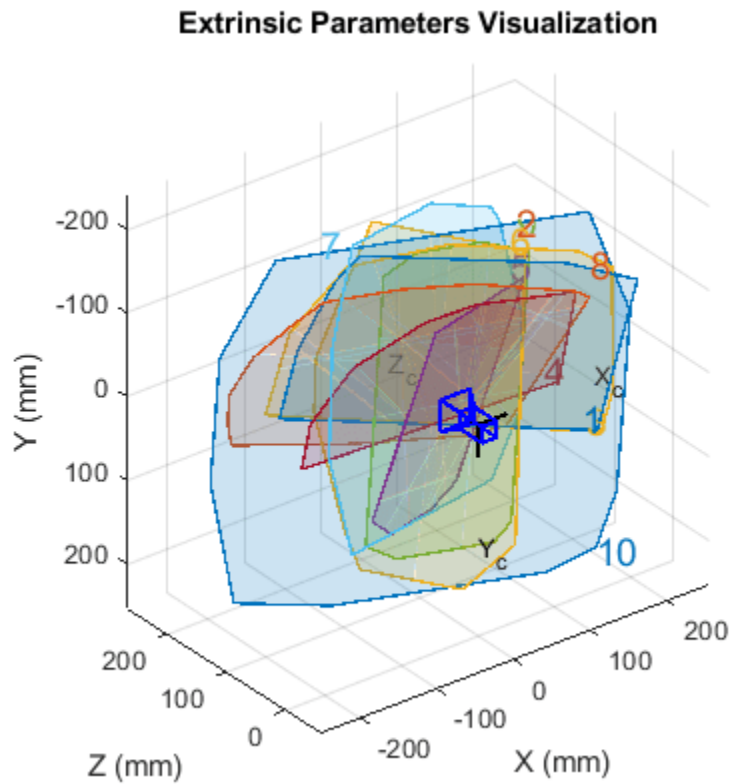

drawnow

Plot the detected and reprojected points.

```
figure
imshow(I);
hold on
plot(imagePoints(:,1,10),imagePoints(:,2,10),'go');
plot(params.ReprojectedPoints(:,1,10),params.ReprojectedPoints(:,2,10),'r+');
legend('Detected Points','Reprojected Points');
hold off
```

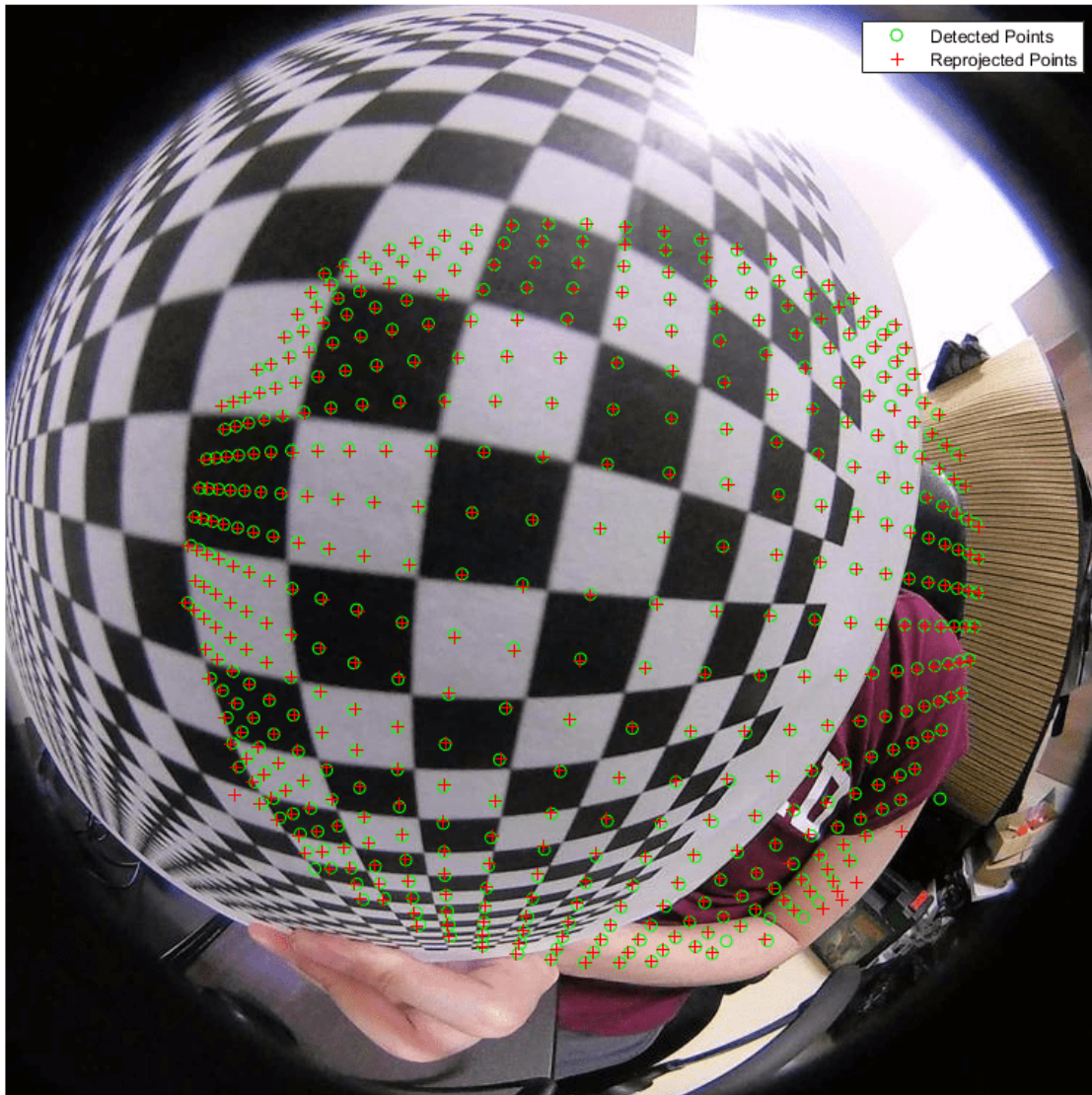

Input Arguments

imagePoints — Key points of calibration pattern

M-by-2-by-*numImages* array

Key points of calibration pattern, specified as an *M*-by-2-by-*numImages* array of $[x,y]$ intrinsic image coordinates. The number of images, *numImages*, must be greater than 2. The number of keypoint coordinates in each pattern, *M*, must be greater than 3. To include partially detected patterns in the estimate, use `[NaN, NaN]` as x - y coordinates for missing keypoints.

Data Types: `single` | `double`

worldPoints — Key points of calibration pattern in world coordinates*M*-by-2 matrix

Key points of calibration pattern in world coordinates, specified as an *M*-by-2 matrix of *M* [*x*,*y*] world coordinates. Because the pattern must be planar, the *z*-coordinates are zero.

Data Types: single | double

imageSize — Image size[*mrows* *ncols*] vector

Image size, specified as an [*mrows* *ncols*] vector.

Name-Value Pair Arguments

Specify optional comma-separated pairs of *Name*, *Value* arguments. *Name* is the argument name and *Value* is the corresponding value. *Name* must appear inside quotes. You can specify several name and value pair arguments in any order as *Name*₁, *Value*₁, . . . , *Name*_{*N*}, *Value*_{*N*}.

Example: 'WorldUnits', 'mm' sets the world point units to millimeters.

EstimateAlignment — Estimate axes alignment

false (default) | true

Estimate the axes alignment, specified as the comma-separated pair consisting of 'EstimateAlignment' and false or true. Set to true if the optical axis of the fisheye lens is not perpendicular to the image plane.

WorldUnits — World point units

'mm' (default) | character vector | string scalar

World point units, specified as the comma-separated pair consisting of 'WorldUnits' and a character vector or string scalar. This argument is used simply to store the unit type and does not affect any calculations.

Output Arguments**fisheyeParams — Fisheye camera parameters**

fisheyeParameters object

Fisheye camera parameters, returned as a fisheyeParameters object.

imagesUsed — Images used to estimate camera parameters*P*-by-1 logical array

Images used to the estimate camera parameters, returned as a *P*-by-1 logical array. *P* corresponds to the number of images. A logical true value indicates the index of an image used to estimate the camera parameters.

estimationErrors — Standard errors of estimated parameters

fisheyeCalibrationErrors object

Standard errors of estimated parameters, returned as a fisheyeCalibrationErrors object.

References

- [1] Scaramuzza, D., A. Martinelli, and R. Siegwart. "A Toolbox for Easy Calibrating Omnidirectional Cameras." *Proceedings to IEEE International Conference on Intelligent Robots and Systems (IROS 2006)*. Beijing, China, October 7-15, 2006.
- [2] Urban, S., J. Leitloff, and S. Hinz. "Improved Wide-Angle, Fisheye and Omnidirectional Camera Calibration." *ISPRS Journal of Photogrammetry and Remote Sensing*. Vol. 108, 2015, pp.72-79.

See Also

`detectCheckerboardPoints` | `fisheyeParameters` | `fisheyeIntrinsics` |
`generateCheckerboardPoints` | `showExtrinsics` | `showReprojectionErrors` |
`undistortFisheyeImage` | `fisheyeCalibrationErrors`

Topics

"Fisheye Calibration Basics"

"Configure Monocular Fisheye Camera" (Automated Driving Toolbox)

Introduced in R2017b

undistortFisheyeImage

Correct fisheye image for lens distortion

Syntax

```
J = undistortFisheyeImage(I,intrinsics)
[J,camIntrinsics] = undistortFisheyeImage(I,intrinsics)
[ ___ ] = undistortFisheyeImage( ___ ,interp)
[ ___ ] = undistortFisheyeImage( ___ ,Name,Value)
```

Description

`J = undistortFisheyeImage(I,intrinsics)` removes lens distortion for image `I` and returns the result as image `J`.

`[J,camIntrinsics] = undistortFisheyeImage(I,intrinsics)` also returns a `cameraIntrinsics` object, which corresponds to a virtual pinhole camera.

`[___] = undistortFisheyeImage(___ ,interp)` specifies the interpolation method, `interp`, using the preceding syntaxes.

`[___] = undistortFisheyeImage(___ ,Name,Value)` specifies one or more `Name,Value` pair arguments. Unspecified properties have their default values.

Examples

Correct Fisheye Image for Lens Distortion

Remove lens distortion from a fisheye image by detecting a checkboard calibration pattern and calibrating the camera. Then, display the results.

Gather a set of checkerboard calibration images.

```
images = imageDatastore('calibrationImages');
```

Detect the calibration pattern from the images. The 'PartialDetections' Name-Value argument is set to true by default allowing detection of partial checkerboards.

```
[imagePoints,boardSize] = detectCheckerboardPoints(images.Files, 'HighDistortion', true);
```

Generate world coordinates for the corners of the checkerboard squares.

```
squareSize = 20; % millimeters
worldPoints = generateCheckerboardPoints(boardSize,squareSize);
```

Estimate the fisheye camera calibration parameters based on the image and world points. Use the first image to get the image size.

```
I = readimage(images,10);
imageSize = [size(I,1) size(I,2)];
params = estimateFisheyeParameters(imagePoints,worldPoints,imageSize);
```

Remove lens distortion from the first image I and display the results.

```
J1 = undistortFisheyeImage(I,params.Intrinsics);  
figure  
imshowpair(I,J1,'montage')  
title('Original Image (left) vs. Corrected Image (right)')
```

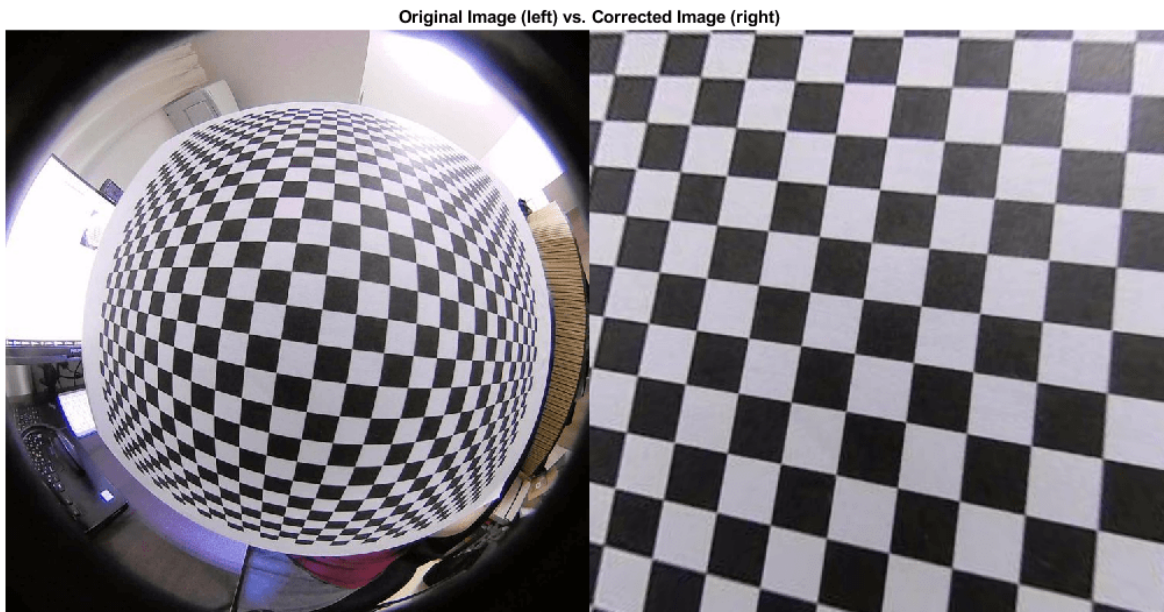

```
J2 = undistortFisheyeImage(I,params.Intrinsics,'OutputView','same', 'ScaleFactor', 0.2);  
figure  
imshow(J2)  
title('Output View with low Scale Factor')
```

Output View with low Scale Factor

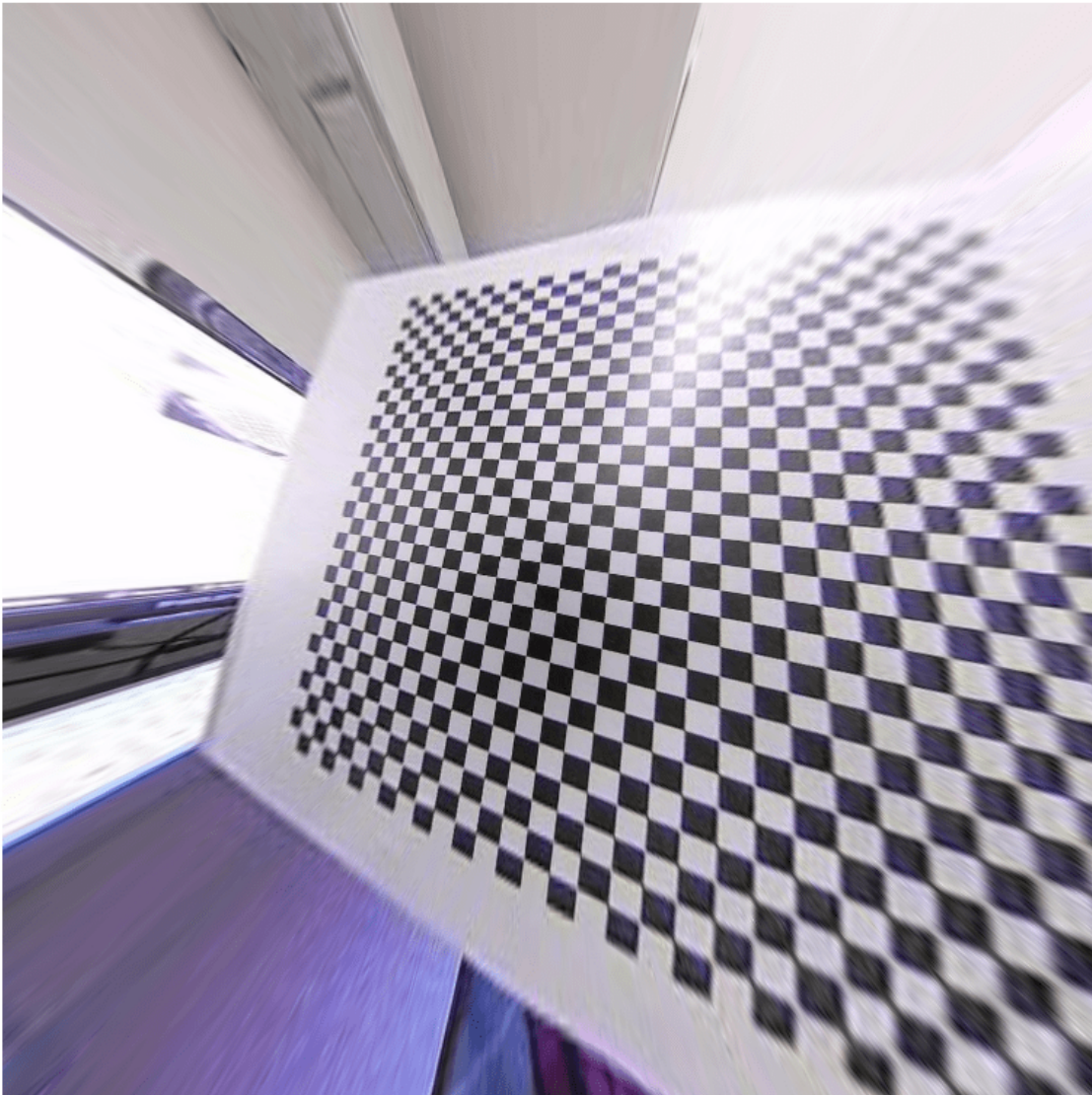

Input Arguments

I — Input image

M-by-*N*-by-3 truecolor image | *M*-by-*N* 2-D grayscale image

Input image, specified as an *M*-by-*N*-by-3 truecolor or *M*-by-*N* 2-D grayscale image. The input image must be real and nonsparse.

Data Types: single | double | int16 | uint8 | uint16 | logical

intrinsics — Fisheye intrinsic camera parameters

fisheyeIntrinsics object

Fisheye intrinsic camera parameters, specified as a `fisheyeIntrinsics` object.

interp — Interpolation method

'bilinear' (default) | 'nearest' | 'cubic'

Interpolation method to use on the input image, specified as 'bilinear', 'nearest', or 'cubic'.

Name-Value Pair Arguments

Specify optional comma-separated pairs of `Name`, `Value` arguments. `Name` is the argument name and `Value` is the corresponding value. `Name` must appear inside quotes. You can specify several name and value pair arguments in any order as `Name1, Value1, ..., NameN, ValueN`.

Example: 'ScaleFactor',2 sets the scale factor to increase the zoom in the camera view.

OutputView — Size of the output image

'same' (default) | 'full' | 'valid'

Size of the output image, specified as either 'same', 'full', or 'valid'.

ScaleFactor — Scale factor for focal length

1 (default) | scalar | [sx sy] vector

Scale factor for the focal length of a virtual camera perspective, in pixels, specified as a scalar or an [sx sy] vector. Specify a vector to scale the x and y axes individually. Increase the scale to zoom in the perspective of the camera view.

FillValues — Output pixel fill values

0 (default) | scalar | 3-element vector

Output pixel fill values, specified as the comma-separated pair consisting of 'FillValues' and scalar or 3-element vector. When the corresponding inverse-transformed location in the input image lies completely outside the input image boundaries, you use the fill values for output pixels. When you use a 2-D grayscale input image, `FillValues` must be a scalar. When you use a truecolor image, `FillValues` can be a scalar or a 3-element vector of RGB values.

Output Arguments**J — Undistorted image**

M-by-*N*-by-3 truecolor image | *M*-by-*N* 2-D grayscale image

Undistorted image, returned as an *M*-by-*N*-by-3 truecolor or *M*-by-*N* 2-D grayscale image.

Data Types: single | double | int16 | uint8 | uint16 | logical

camIntrinsics — Undistorted intrinsics of virtual camera

`cameraIntrinsics` object

Undistorted intrinsics of a virtual camera, returned as a `cameraIntrinsics` object. The `camIntrinsics` object represents a virtual pinhole camera. You can use this object with the pinhole model calibration workflow functions. These intrinsics are for a camera that has a perspective that produces the undistorted image.

Tips

- The Computer Vision Toolbox calibration algorithm uses the fisheye camera model proposed by Scaramuzza [1] on page 3-1105.

References

- [1] Scaramuzza, D., A. Martinelli, and R. Siegwart. "A Toolbox for Easy Calibrating Omnidirectional Cameras." *Proceedings to IEEE International Conference on Intelligent Robots and Systems, (IROS)*. Beijing, China, October 7-15, 2006.

See Also

`undistortFisheyePoints` | `fisheyeIntrinsics` | `estimateFisheyeParameters` | `cameraIntrinsics`

Topics

"Fisheye Calibration Basics"

"What Is Camera Calibration?"

Introduced in R2017b

undistortFisheyePoints

Correct point coordinates for fisheye lens distortion

Syntax

```
undistortedPoints = undistortFisheyePoints(points,intrinsics)
undistortedPoints = undistortFisheyePoints( ____,scaleFactor)
[ ____,camIntrinsics] = undistortFisheyePoints( ____)
[ ____,reprojectionErrors] = undistortFisheyePoints( ____)
```

Description

`undistortedPoints = undistortFisheyePoints(points,intrinsics)` returns point coordinates corrected for fisheye lens distortion.

`undistortedPoints = undistortFisheyePoints(____,scaleFactor)` returns corrected point coordinates using the `scaleFactor` and the previous inputs.

`[____,camIntrinsics] = undistortFisheyePoints(____)` also returns a `cameraIntrinsics` object, which corresponds to a virtual perspective camera that produces undistorted points.

`[____,reprojectionErrors] = undistortFisheyePoints(____)` also returns `reprojectionErrors` used to evaluate the accuracy of undistorted points. The function computes the reprojection errors by applying distortion to the points, and taking the distances between the result and the corresponding input points.

Examples

Undistort Checkerboard Points from Fisheye Image

Undistort and translate checkerboard points detected in a calibration image, and then display the results.

Create an `imageDatastore` object containing checkerboard calibration images.

```
images = imageDatastore(fullfile(toolboxdir('vision'),'visiondata',...
    'calibration','gopro'));
imageFileNames = images.Files;
```

Detect the calibration pattern from the images.

```
[imagePoints,boardSize] = detectCheckerboardPoints(imageFileNames);
```

Generate world coordinates for the corners of the checkerboard squares.

```
squareSize = 29; % millimeters
worldPoints = generateCheckerboardPoints(boardSize,squareSize);
```

Estimate the fisheye parameters from the image and world points. Get the image size from the first image.

```
I = readimage(images,10);
imageSize = [size(I,1) size(I,2)];
params = estimateFisheyeParameters(imagePoints,worldPoints,imageSize);
```

In the first image, detect the checkerboard points.

```
points = detectCheckerboardPoints(I);
```

Undistort the points and image.

```
[undistortedPoints,intrinsics1] = undistortFisheyePoints(points,params.Intrinsics);
[J, intrinsics2] = undistortFisheyeImage(I,params.Intrinsics,'OutputView','full');
```

Translate the undistorted points.

```
newOrigin = intrinsics2.PrincipalPoint - intrinsics1.PrincipalPoint;
undistortedPoints = [undistortedPoints(:,1) + newOrigin(1), ...
                    undistortedPoints(:,2) + newOrigin(2)];
```

Display the results.

```
figure
imshow(I)
hold on
plot(points(:,1),points(:,2),'r*-.')
title('Detected Points')
hold off
```



```
figure
imshow(J)
hold on
plot(undistortedPoints(:, 1),undistortedPoints(:, 2),'g*-',)
title('Undistorted Points')
hold off
```

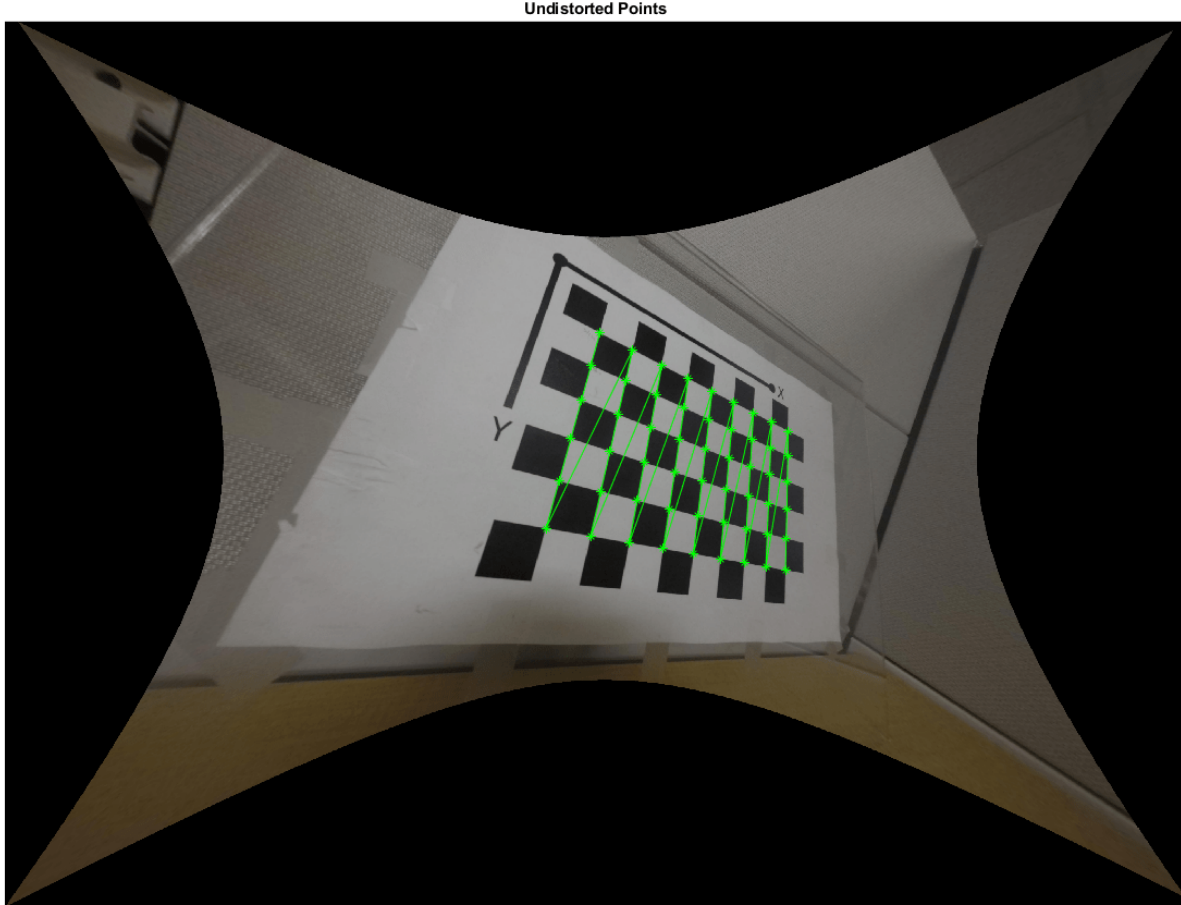

Input Arguments

points — Input points

M-by-2 matrix

Input points, specified as an *M*-by-2 matrix of *M* [x y] coordinates.

intrinsic — Fisheye intrinsic camera parameters

`fisheyeIntrinsic` object

Fisheye intrinsic camera parameters, specified as a `fisheyeIntrinsic` object.

scaleFactor — Scale factor for points

1 (default) | scalar | [*sx sy*] vector

Scale factor for points, specified as a scalar or an [*sx sy*] vector. Specify a vector to scale the *x* and *y* axes individually. Increase the scale to zoom in the perspective of the camera view.

Output Arguments

undistortedPoints — Undistorted points

M-by-2 matrix

Undistorted points, returned as an *M*-by-2 matrix of *M* number of [x y] coordinates. If `points` is `double`, then `undistortedPoints` is `double`. Otherwise, `undistortedPoints` is `single`.

Data Types: `single` | `double`

camIntrinsics — Undistorted intrinsics of virtual camera

`cameraIntrinsics` object

Undistorted intrinsics of a virtual camera, returned as a `cameraIntrinsics` object. These intrinsics are for a camera that has a perspective that produces the undistorted image.

reprojectionErrors — Reprojection errors

M-by-1 vector

Reprojection errors, returned as an *M*-by-1 vector. The function computes the reprojection errors by applying distortion to the undistorted points and taking the distances between the results and the corresponding input points. Errors are expressed in pixels.

See Also

`undistortFisheyeImage` | `fisheyeIntrinsics`

Topics

“Fisheye Calibration Basics”

Introduced in R2017b

pointsToWorld

Determine world coordinates of image points

Syntax

```
worldPoints = pointsToWorld(intrinsics,tform,imagePoints)
worldPoints = pointsToWorld(intrinsics,rotationMatrix,translationVector,
imagePoints)
```

Description

`worldPoints = pointsToWorld(intrinsics,tform,imagePoints)` maps undistorted image points `imagePoints`, onto points on the X-Y plane in world coordinates, `worldPoints` using the rigid3d transformation `tform`.

`worldPoints = pointsToWorld(intrinsics,rotationMatrix,translationVector, imagePoints)` returns world points on the X-Y plane, which correspond to the input image points. Points are converted using the input rotation matrix, translation vector, and camera intrinsics.

Examples

Map Image Points of Fisheye Image to World Coordinates

Map the points of a fisheye image to world coordinates and compare these points to the ground truth points. A series of checkerboard pattern images are used to estimate the fisheye parameters and calibrate the camera.

Create a set of checkerboard calibration images.

```
images = imageDatastore(fullfile(toolboxdir('vision'),'visiondata',...
    'calibration','gopro'));
```

Detect the checkerboard corners in the images. Leave the last image for testing.

```
[imagePoints,boardSize] = detectCheckerboardPoints(images.Files(1:end-1));
```

Generate the world coordinates of the checkerboard corners in the pattern-centric coordinate system, with the upper-left corner at (0,0).

```
squareSize = 29; % millimeters
worldPoints = generateCheckerboardPoints(boardSize,squareSize);
```

Estimate the fisheye camera parameters from the image and world points. Use the first image to get image size.

```
I = imread(images.Files{end});
imageSize = [size(I,1) size(I,2)];
fisheyeParams = estimateFisheyeParameters(imagePoints,worldPoints,imageSize);
intrinsics = fisheyeParams.Intrinsics;
```

Find the reference object in the new image.

```
imagePoints = detectCheckerboardPoints(I, "PartialDetections", false);
```

Compute new extrinsics.

```
[R,t] = extrinsics(imagePoints,worldPoints,intrinsics);
```

Map image points to world coordinates in the X-Y plane.

```
newWorldPoints = pointsToWorld(intrinsics,R,t,imagePoints);
```

Compare estimated world points to the ground truth points.

```
plot(worldPoints(:,1),worldPoints(:,2),'gx');
hold on
plot(newWorldPoints(:,1),newWorldPoints(:,2),'ro');
legend('Ground Truth','Estimates');
hold off
```

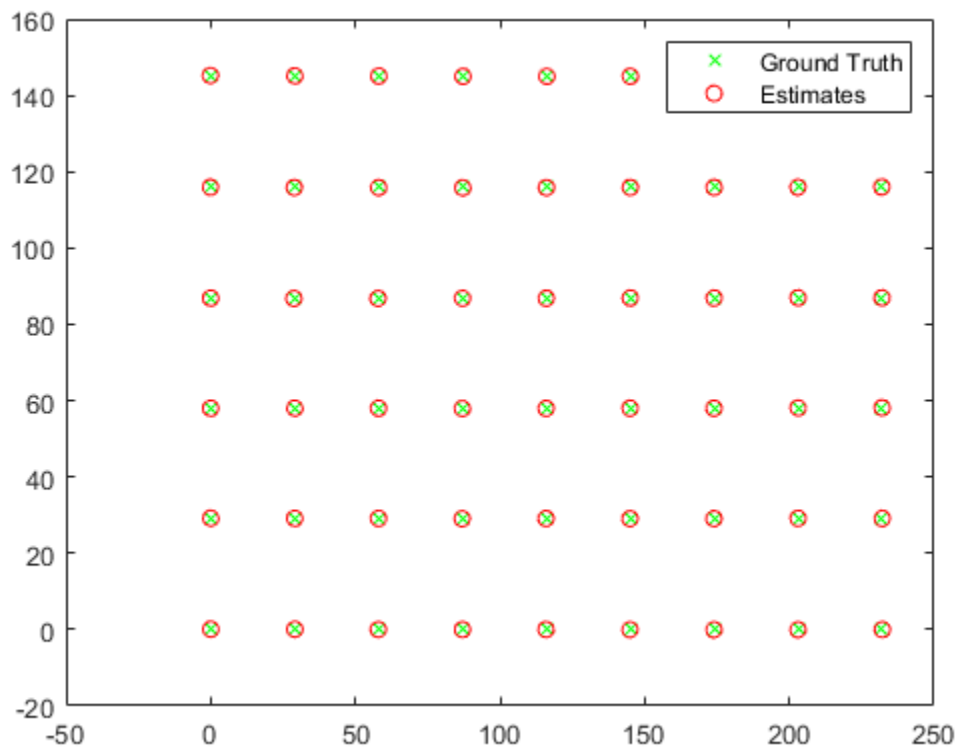

Input Arguments

intrinsics — Camera intrinsics

cameraIntrinsics object | fisheyeIntrinsics object

Camera parameters, specified as a `cameraIntrinsics` or a `fisheyeIntrinsics` object. The objects store information about a camera's intrinsic calibration parameters, including the lens distortion parameters.

tform — Transformation

rigid3d object

Transformation of the camera in world coordinates, specified as a `rigid3d` object.

rotationMatrix — 3-D rotation

3-by-3 matrix

3-D rotation of the world coordinates relative to the image coordinates, specified as a 3-by-3 matrix. The rotation matrix, together with the translation vector, enable you to transform points from the world coordinate system to the camera coordinate system. The `rotationMatrix` and `translationVector` inputs must be the same data type.

$$[x \ y \ z] = [X \ Y \ Z]R + t$$

Diagram illustrating the transformation equation: $[x \ y \ z] = [X \ Y \ Z]R + t$. The left side is labeled "camera coordinates" (brown text). The right side consists of three terms: $[X \ Y \ Z]$ is labeled "world coordinates" (blue text), R is labeled "rotation matrix" (red text), and t is labeled "translation vector" (green text).

Data Types: double | single

translationVector — 3-D translation

1-by-3 vector

3-D translation of the world coordinates relative to the image coordinates, specified as a 1-by-3 vector. The translation vector, together with the rotation matrix, enable you to transform points from the world coordinate system to the camera coordinate system. The `rotationMatrix` and `translationVector` inputs must be the same data type.

$$[x \ y \ z] = [X \ Y \ Z]R + t$$

Diagram illustrating the transformation equation: $[x \ y \ z] = [X \ Y \ Z]R + t$. The left side is labeled "camera coordinates" (brown text). The right side consists of three terms: $[X \ Y \ Z]$ is labeled "world coordinates" (blue text), R is labeled "rotation matrix" (red text), and t is labeled "translation vector" (green text).

Data Types: double | single

imagePoints — Image points M -by-2 matrix

Image points, specified as an M -by-2 matrix containing M $[x, y]$ coordinates of image points.

When using the `cameraParameters` object as the `cameraParams` input, `pointsToWorld` does not account for lens distortion. Therefore, the `imagePoints` input must contain image points detected in the undistorted image, or they must be undistorted using the `undistortPoints` function. For a `fishEyeIntrinsics` object, the image points are distorted.

Output Arguments**worldPoints — World coordinates** M -by-2 matrix

World coordinates, returned as an M -by-2 matrix. M represents the number of undistorted points in $[x, y]$ world coordinates.

See Also

Apps

Camera Calibrator | **Stereo Camera Calibrator**

Functions

undistortImage | **estimateCameraParameters** | **extrinsics** | **undistortPoints** | **fishEyeIntrinsics** | **extrinsicsToCameraPose** | **estimateWorldCameraPose** | **cameraPoseToExtrinsics** | **worldToImage** | **relativeCameraPose**

Objects

cameraParameters | **fishEyeParameters** | **cameraIntrinsics** | **fishEyeIntrinsics**

Introduced in R2016a

worldToImage

Project world points into image

Syntax

```
imagePoints = worldToImage(intrinsics,tform,worldPoints)
imagePoints = worldToImage(intrinsics,rotationMatrix,translationVector,
worldPoints)
[imagePoints,validIndex] = worldToImage(____)
[____] = worldToImage(____ 'ApplyDistortion',distort)
```

Description

`imagePoints = worldToImage(intrinsics,tform,worldPoints)` projects 3-D world points `worldPoints` into points on an image, `imagePoints`. `intrinsics` can be a `cameraIntrinsics` or a `fishEyeIntrinsics` object. `tform` is a `rigid3d` object.

`imagePoints = worldToImage(intrinsics,rotationMatrix,translationVector,worldPoints)` returns the projection of 3-D world points into an image given the camera intrinsics, the rotation matrix, and the translation vector.

`[imagePoints,validIndex] = worldToImage(____)` also returns the indices of valid image points that are within the boundary of the image using any of the previous syntax inputs.

`[____] = worldToImage(____ 'ApplyDistortion',distort)` returns the projection with the option of applying distortion. This syntax is supported for nonfish-eye camera parameters.

Examples

Project World Points into Image

Create a set of calibration images.

```
images = imageDatastore(fullfile(toolboxdir('vision'),'visiondata', ...
    'calibration','slr'));
```

Detect the checkerboard corners in the images.

```
[imagePoints,boardSize] = detectCheckerboardPoints(images.Files);
```

Generate the world coordinates of the checkerboard corners in the pattern-centric coordinate system, with the upper-left corner at (0,0).

```
squareSize = 29; % in millimeters
worldPoints = generateCheckerboardPoints(boardSize,squareSize);
```

Calibrate the camera.

```
cameraParams = estimateCameraParameters(imagePoints,worldPoints);
```

Load the image at a new location.

```

imOrig = imread(fullfile(matlabroot,'toolbox','vision','visiondata', ...
    'calibration','slr','image9.jpg'));

imshow(imOrig,'InitialMagnification',30);

```

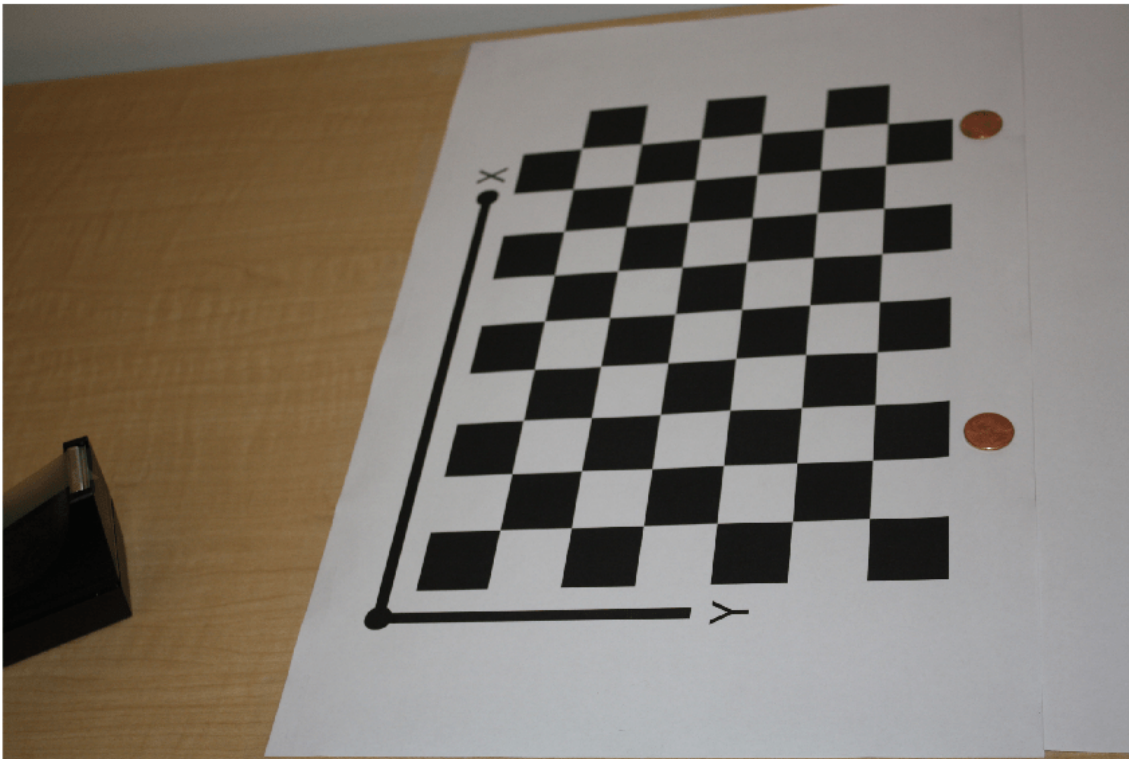

Undistort the image.

```
imUndistorted = undistortImage(imOrig,cameraParams);
```

Find a reference object in the new image.

```
[imagePoints,boardSize] = detectCheckerboardPoints(imUndistorted);
```

Compute new extrinsics.

```
[R,t] = extrinsics(imagePoints,worldPoints,cameraParams);
```

Add a z-coordinate to the world points.

```
zCoord = zeros(size(worldPoints,1),1);
worldPoints = [worldPoints zCoord];
```

Project the world points back into the original image.

```
projectedPoints = worldToImage(cameraParams,R,t,worldPoints);
hold on
plot(projectedPoints(:,1),projectedPoints(:,2),'g*-' );
```

```
legend('Projected points');
hold off
```

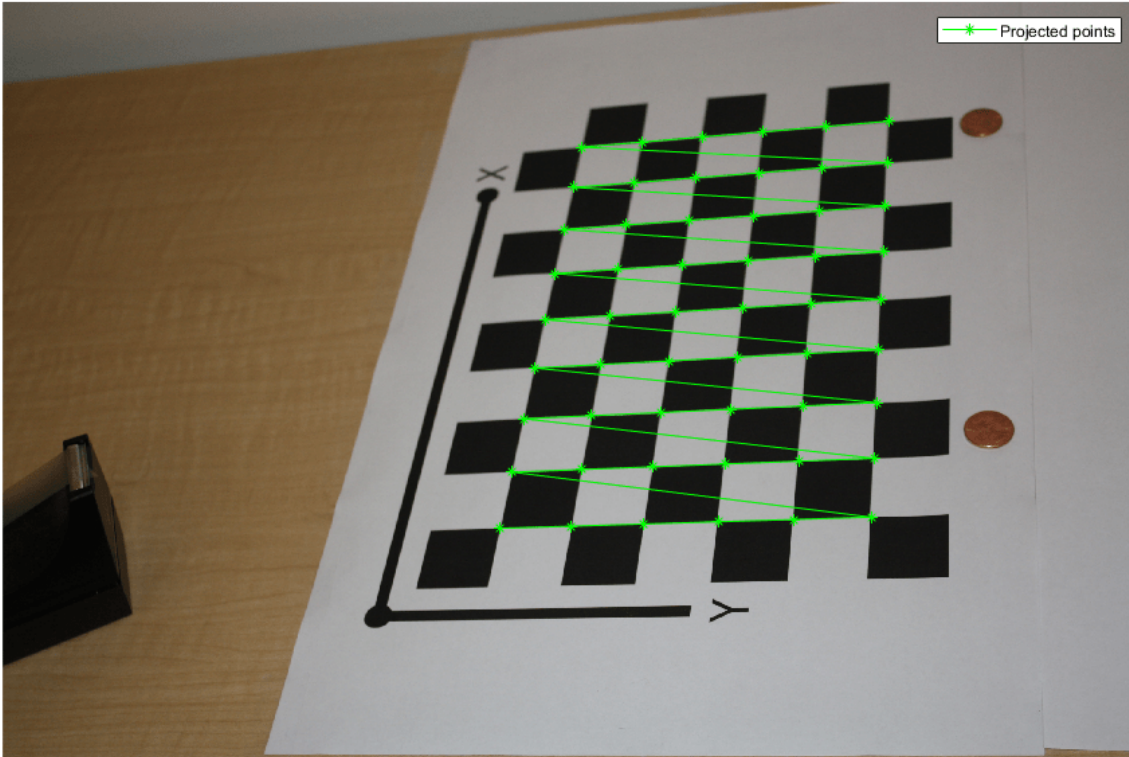

Input Arguments

tform — Transformation

`rigid3d` object

Transformation of the camera in world coordinates, specified as a `rigid3d` object.

intrinsics — Camera intrinsics

`cameraIntrinsics` object | `fisheyeIntrinsics` object

Camera parameters, specified as a `cameraIntrinsics` or a `fisheyeIntrinsics` object. The objects store information about a camera's intrinsic calibration parameters, including the lens distortion parameters.

rotationMatrix — 3-D rotation

3-by-3 matrix

3-D rotation of the world coordinates relative to the image coordinates, specified as a 3-by-3 matrix. The rotation matrix, together with the translation vector, enable you to transform points from the world coordinate system to the camera coordinate system. The `rotationMatrix` and `translationVector` inputs must be the same data type.

$$[x \ y \ z] = [X \ Y \ Z]R + t$$

camera coordinates world coordinates rotation matrix translation vector

Data Types: double | single

translationVector — 3-D translation

1-by-3 vector

3-D translation of the world coordinates relative to the image coordinates, specified as a 1-by-3 vector. The translation vector, together with the rotation matrix, enable you to transform points from the world coordinate system to the camera coordinate system. The `rotationMatrix` and `translationVector` inputs must be the same data type.

$$[x \ y \ z] = [X \ Y \ Z]R + t$$

camera coordinates world coordinates rotation matrix translation vector

Data Types: double | single

worldPoints — 3-D world points

M -by-3 matrix

3-D world points, specified as an M -by-3 matrix containing M $[x,y,z]$ coordinates of 3-D world points.

If you use the `tform` input argument then the `worldPoints` coordinates must be in the same units as the `Translation` property of the `tform` object.

distort — Apply lens distortion

false (default) | true

Option to apply lens distortion, specified as `false` or `true`. When you set this argument to `true`, the function applies lens distortion to the output `imagePoints`.

This argument is valid only when using a `cameraParameters` object as the `cameraParams` input.

Output Arguments

imagePoints — Image points

M -by-2 matrix

Image points, returned as an M -by-2 matrix of M $[x,y]$ point coordinates.

validIndex — Valid index

M -by-1 logical array

Valid index returned as an M -by-1 logical array that specify the indices of valid image points in the `imagePoints` output that are within the boundary of the image. The world points that correspond to the indices are inside the field of view of the camera.

See Also

Apps

[Camera Calibrator](#) | [Stereo Camera Calibrator](#)

Functions

[undistortImage](#) | [estimateCameraParameters](#) | [extrinsics](#) | [undistortPoints](#) | [fisheyeIntrinsics](#) | [extrinsicsToCameraPose](#) | [estimateWorldCameraPose](#) | [cameraPoseToExtrinsics](#) | [pointsToWorld](#) | [relativeCameraPose](#)

Objects

[cameraParameters](#) | [fisheyeParameters](#) | [cameraIntrinsics](#) | [fisheyeIntrinsics](#) | [rigid3d](#)

Introduced in R2016b

toStruct

Convert a camera parameters object into a struct

Syntax

```
paramStruct = toStruct(cameraParams)
```

Description

`paramStruct = toStruct(cameraParams)` returns a struct containing the camera parameters in the `cameraParams` input object. You can use the struct to create an identical `cameraParameters` object. Use the struct for C code generation. You can call `toStruct`, and then pass the resulting structure into the generated code, which re-creates the `cameraParameters` object.

Input Arguments

cameraParams — Camera parameters

`cameraParameters` object

Camera parameters, specified as a `cameraParameters` object. The object contains the parameters for the camera.

Output Arguments

paramStruct — Camera parameters

struct

Camera parameters, returned as a struct.

See Also

`cameraParameters`

Topics

“Code Generation for Depth Estimation From Stereo Video”

Introduced in R2015a

toStruct

Convert a trained aggregate channel features (ACF) object detector into structure

Syntax

```
detectorStruct = toStruct(acfObjectDetector)
```

Description

`detectorStruct = toStruct(acfObjectDetector)` returns a structure that stores the properties of the input `acfObjectDetector` object in fields. The output structure contains fields `Classifier` and `TrainingOptions`. Use the structure to create an identical `acfObjectDetector` object for C code generation. You can call the `toStruct`, and then pass the resulting structure to a MATLAB function, which recreates the `acfObjectDetector` object.

Examples

Convert ACF Object Detector to Struct

Load the pretrained ACF stop sign detector from the `stopSignDetector.mat` file, which is present in the current working folder as a supporting file.

```
stopSignDetector= load('stopSignDetectorACF.mat');  
detector = stopSignDetector.detector
```

```
detector =
```

```
    acfObjectDetector with properties:
```

```
        ModelName: 'stopSign'  
    ObjectTrainingSize: [34 31]  
        NumWeakLearners: 61
```

Convert the detector to a structure.

```
detectorStruct = toStruct(detector)
```

```
detectorStruct =
```

```
    struct with fields:
```

```
        ModelName: 'stopSign'  
    ObjectTrainingSize: [34 31]  
        NumWeakLearners: 61  
        Classifier: [1x1 struct]
```

TrainingOptions: [1x1 struct]

Input Arguments

acfObjectDetector — ACF object detector

acfObjectDetector object

ACF object detector, specified as an acfObjectDetector object. To create this object, call the trainACFObjectDetector function with training data as input.

Output Arguments

detectorStruct — ACF object properties

structure

ACF object detector, returned as a structure containing the object properties into fields.

See Also

Topics

“Generate Code for Detecting Objects in Images by Using ACF Object Detector”

displayErrors

Display standard errors of camera parameter estimates

Syntax

```
displayErrors(estimationErrors, cameraParams)
```

Description

`displayErrors(estimationErrors, cameraParams)` displays the camera parameters and corresponding standard errors.

Examples

Display Fisheye Camera Calibration Errors

Gather a set of checkerboard calibration images.

```
images = imageDatastore(fullfile(toolboxdir('vision'),'visiondata',...
    'calibration','gopro'));
```

Detect the calibration pattern from the images.

```
[imagePoints, boardSize] = detectCheckerboardPoints(images.Files);
```

Generate world coordinates for the corners of the checkerboard squares.

```
squareSize = 29; % millimeters
worldPoints = generateCheckerboardPoints(boardSize, squareSize);
```

Estimate the fisheye parameters using image and world points. Use the first image to get the image size. Also, store the errors from the calibration.

```
I = readimage(images,1);
imageSize = [size(I,1) size(I,2)];
[params,~,errors] = estimateFisheyeParameters(imagePoints, ...
    worldPoints,imageSize);
```

Display the standard errors of the estimated camera parameters.

```
displayErrors(errors,params);
```

```
Standard Errors of Estimated Camera Parameters
```

```
-----
```

```
Intrinsics
```

```
-----
```

```
Mapping coefficients: [ 875.0783 +/- 0.9451 -0.0003 +/- -0.0000 -0.0000 +/- 0.0000
```

```
Distortion center (pixels): [ 1005.8164 +/- 0.6871 743.0346 +/- 0.5578 ]
```

```
Stretch matrix parameters: [ 1.0000 +/- 0.0000 0.0000 +/- 0.0000 0.0000 +/- 0.0000
```

```
Extrinsics
```

Rotation vectors:

[-0.0699 +/- 0.0010	-0.0267 +/- 0.0009	0.0258 +/- 0.0009
[0.3628 +/- 0.0010	0.2950 +/- 0.0009	-0.1967 +/- 0.0009
[-0.2159 +/- 0.0009	0.3442 +/- 0.0009	-0.1941 +/- 0.0009
[0.0282 +/- 0.0009	-0.3784 +/- 0.0009	0.0829 +/- 0.0009
[0.0146 +/- 0.0008	0.4575 +/- 0.0009	-0.1215 +/- 0.0009
[0.6775 +/- 0.0008	0.1089 +/- 0.0008	-0.0386 +/- 0.0009
[-0.4936 +/- 0.0008	0.0063 +/- 0.0008	0.0486 +/- 0.0009
[0.3823 +/- 0.0008	0.2797 +/- 0.0008	0.1509 +/- 0.0009
[0.5171 +/- 0.0008	-0.3295 +/- 0.0008	0.0541 +/- 0.0009
[-0.1896 +/- 0.0008	-0.3543 +/- 0.0009	0.2637 +/- 0.0009
[-0.2911 +/- 0.0008	0.3680 +/- 0.0008	-0.1329 +/- 0.0009

Translation vectors (mm):

[-132.9182 +/- 0.1609	-82.6066 +/- 0.1356	195.1106 +/- 0.2311
[-178.9931 +/- 0.1905	-15.7750 +/- 0.1712	241.7127 +/- 0.2799
[-183.7957 +/- 0.2168	-56.7378 +/- 0.1884	269.9740 +/- 0.2799
[-17.6295 +/- 0.1315	-70.2875 +/- 0.1041	157.0827 +/- 0.1933
[-161.9824 +/- 0.1808	-46.9681 +/- 0.1569	228.4061 +/- 0.2307
[-122.4240 +/- 0.1309	-16.0260 +/- 0.1153	162.6247 +/- 0.2077
[-112.4268 +/- 0.1745	-125.5876 +/- 0.1428	212.8055 +/- 0.2150
[-148.7137 +/- 0.1387	-72.5409 +/- 0.1260	173.7615 +/- 0.2080
[-49.5392 +/- 0.0919	-24.8329 +/- 0.0745	104.3541 +/- 0.1500
[-3.4045 +/- 0.1274	-93.4074 +/- 0.1010	155.8247 +/- 0.1693
[-160.7344 +/- 0.1855	-51.9152 +/- 0.1600	234.4075 +/- 0.2311

Input Arguments

estimationErrors — Standard errors of estimated parameters

cameraCalibrationErrors object | fisheyeCalibrationErrors object

Standard errors of estimated parameters, specified as a cameraCalibrationErrors or fisheyeCalibrationErrors object.

cameraParams — Camera parameters

cameraParameters object | fisheyeParameters object

Camera parameters, specified as a cameraParameters or fisheyeParameters object. These objects contain the intrinsic, extrinsic, and lens distortion parameters of a camera.

- To create a cameraParameters, use the estimateCameraParameters function or the **Camera Calibrator** app.
- To create a fisheyeParameters, use the estimateFisheyeParameters function.

See Also

Functions

estimateCameraParameters | estimateFisheyeParameters

Objects

fisheyeParameters | cameraParameters

Apps
Camera Calibrator

Topics
"Evaluating the Accuracy of Single Camera Calibration"

Introduced in R2017b

info

Information about specified video file

Syntax

```
S = info(videoFReader)
```

Description

`S = info(videoFReader)` returns a MATLAB structure, `S`, with information about the video file specified in the `Filename` property.

Input Arguments

videoFReader — Video file reader object

object (default)

Video file reader, specified as a `vision.VideoFileReader` System object.

Output Arguments

S — Information about input file

structure

Information about input file, returned as a structure. The fields and possible values for the structure `S` are described below:

Audio	Logical value indicating if the file has audio content.
Video	Logical value indicating if the file has video content.
VideoFrameRate	Frame rate of the video stream in frames per second. The value may vary from the actual frame rate of the recorded video, and takes into consideration any synchronization issues between audio and video streams when the file contains both audio and video content. This implies that video frames may be dropped if the audio stream leads the video stream by more than $1/(\text{actual video frames per second})$.
VideoSize	Video size as a two-element numeric vector of the form: [VideoWidthInPixels, VideoHeightInPixels]
VideoFormat	Video signal format.

Introduced in R2012a

isDone

End-of-file status (logical)

Syntax

```
status = isDone(videoFReader)
```

Description

`status = isDone(videoFReader)` returns a logical value indicating that the `VideoFileReader` System object `videoFReader`, has reached the end of the multimedia file after playing it `PlayCount` number of times. After the object plays the file the number of times set by the `PlayCount` property, it sets the status to `true`.

Examples

Read and Play a Video File

Load the video using a video reader object.

```
videoFReader = vision.VideoFileReader('ecolicells.avi');
```

Create a video player object to play the video file.

```
videoPlayer = vision.VideoPlayer;
```

Use a while loop to read and play the video frames. Pause for 0.1 seconds after displaying each frame.

```
while ~isDone(videoFReader)
    videoFrame = videoFReader();
    videoPlayer(videoFrame);
    pause(0.1)
end
```

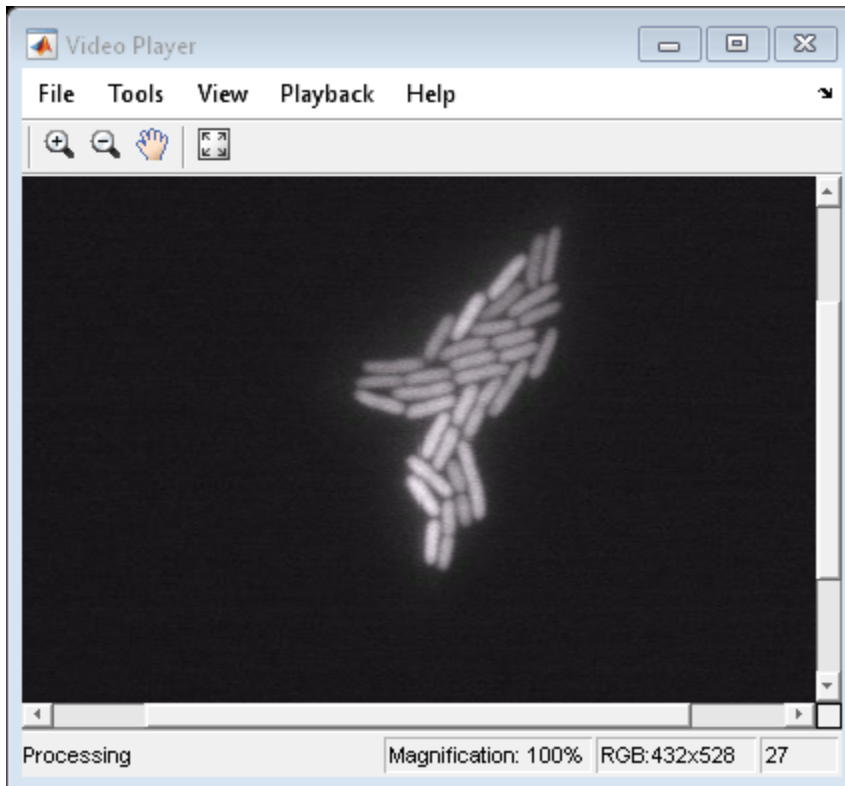

Release the objects.

```
release(videoPlayer);  
release(videoFReader);
```

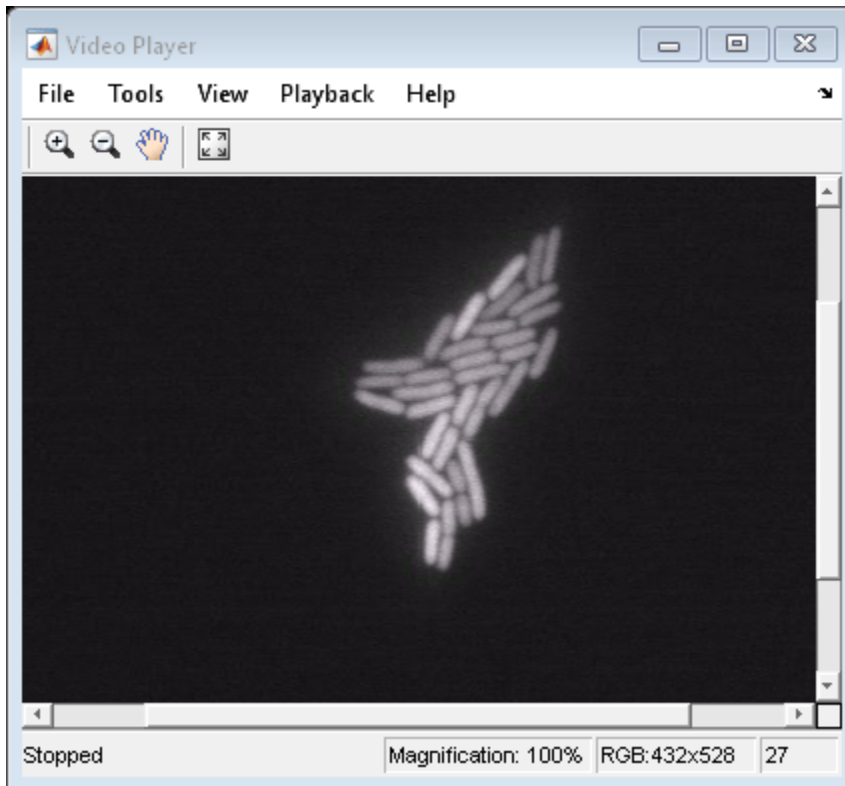

Input Arguments

videoFReader — Video file reader object
object (default)

Video file reader, specified as a `vision.VideoFileReader` System object.

Output Arguments

status — Status of reader file
`true` | `false`

Status of reader file, returned as `true` or `false`.

Introduced in R2012a

isOpen

Visible or hidden status for player

Syntax

```
isOpen(player)
```

Description

`isOpen(player)` returns `true` or `false` to indicate whether the player is visible.

Examples

Terminate a Point Cloud Processing Loop

Close the display of continuous point cloud player

Add data to the point cloud player.

```
player = pcplayer([0 1],[0 1],[0 1]);
```

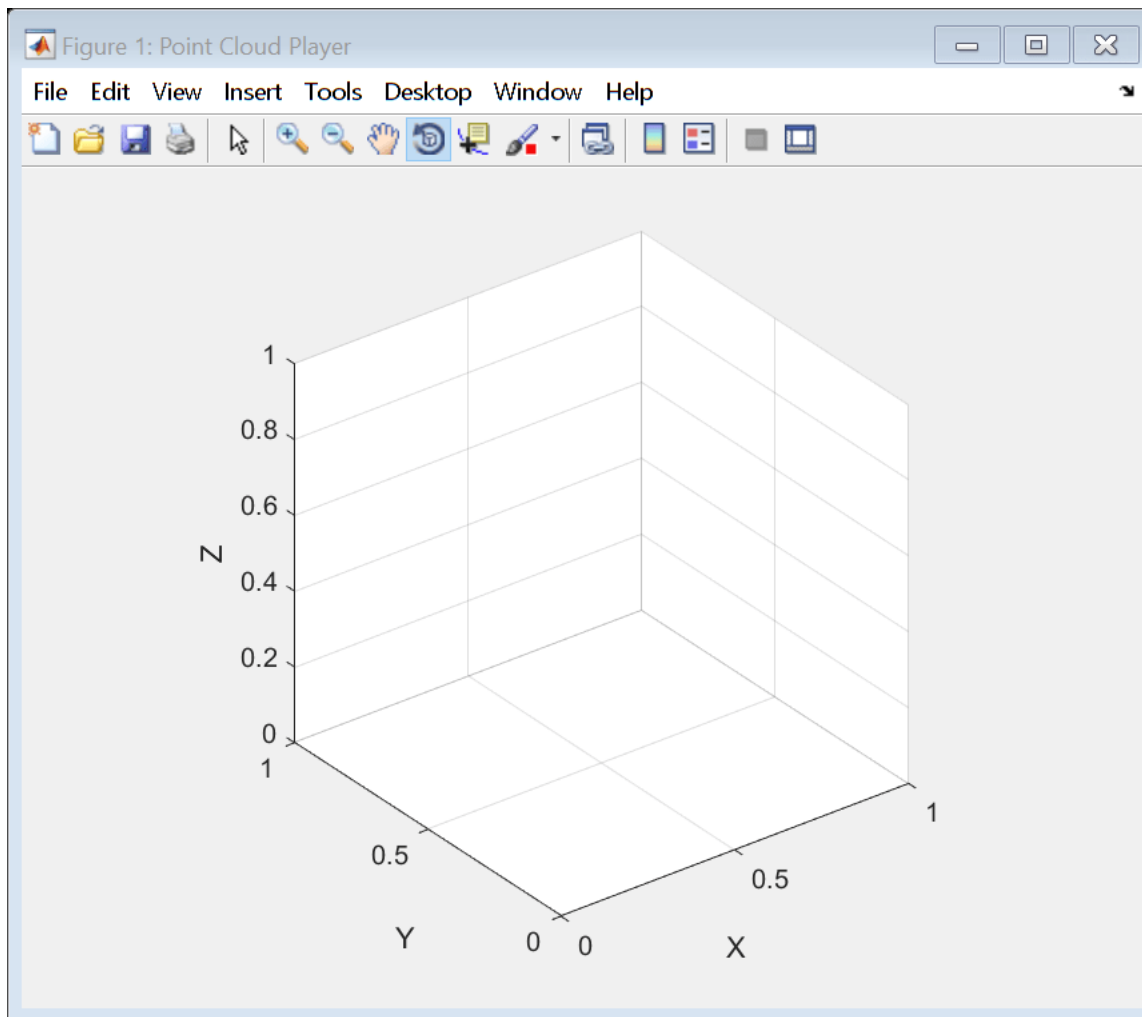
Display continuous player figure. Use the `isOpen` method to check if player figure window is open.

```
while isOpen(player)
    ptCloud = pointCloud(rand(1000,3,'single'));
    view(player, ptCloud);
end
```

Terminate the while-loop by closing `pcplayer` figure window.

Input Arguments

player – Player

object

Video player, specified as a `pcplayer`, or `vision.DeployableVideoPlayer` object.

Introduced in R2012a

segmentGroundFromLidarData

Segment ground points from organized lidar data

Syntax

```
groundPtsIdx = segmentGroundFromLidarData(ptCloud)
groundPtsIdx = segmentGroundFromLidarData(ptCloud,Name,Value)
```

Description

`groundPtsIdx = segmentGroundFromLidarData(ptCloud)` segments organized 3-D lidar data, `ptCloud`, into ground and nonground parts. The lidar sensor must be mounted horizontally such that all ground points are observed in the lidar scan closest to the sensor.

`groundPtsIdx = segmentGroundFromLidarData(ptCloud,Name,Value)` sets properties using one or more name-value pairs. Enclose each property name in quotes. For example, `segmentGroundFromLidarData(ptCloud, 'ElevationAngleDelta', 5)`

Examples

Segment and Plot Organized Lidar Data

Segment ground points and nonground points from an organized lidar point cloud. Create organized point clouds from these segmentations, and display them.

Load an organized lidar, point cloud.

```
ld = load('drivingLidarPoints.mat');
```

Segment ground points from the organized lidar point cloud.

```
groundPtsIdx = segmentGroundFromLidarData(ld.ptCloud);
```

Create an organized point cloud containing only these ground points by using the `select` function. Display this point cloud.

```
groundPtCloud = select(ld.ptCloud,groundPtsIdx);
figure
pcshow(groundPtCloud)
```

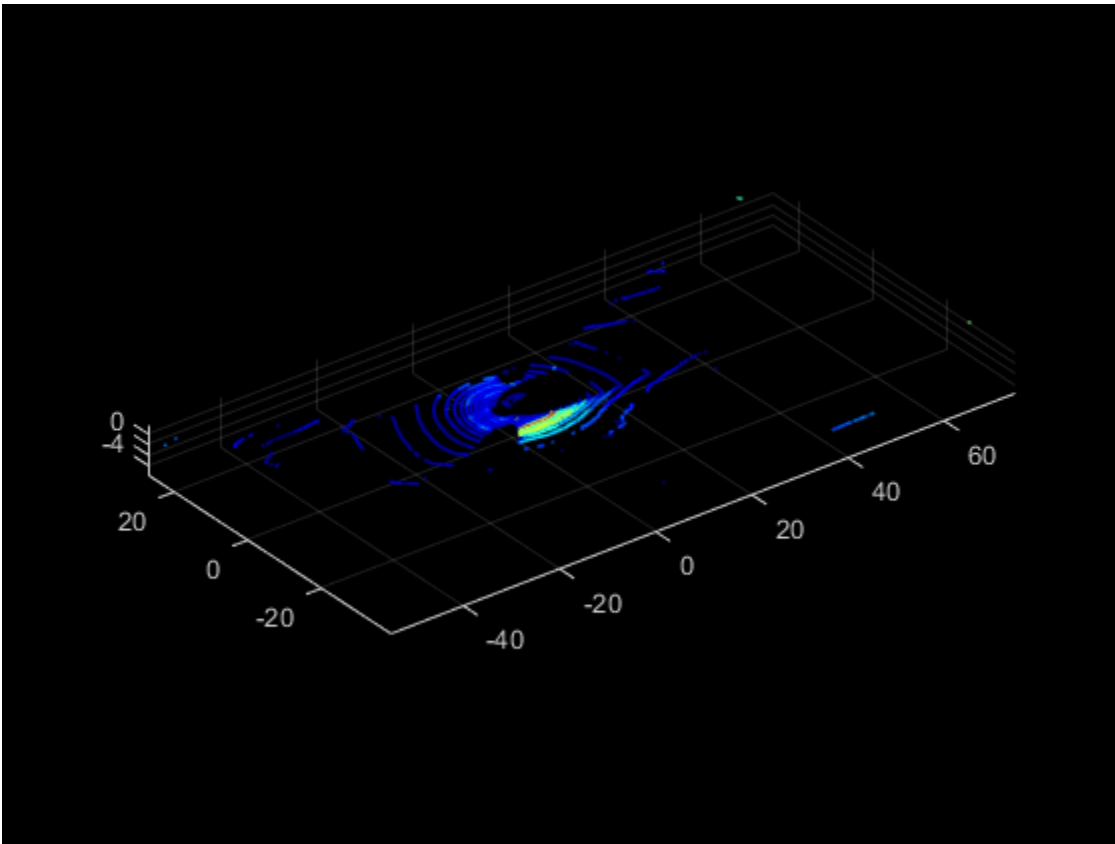

Create an organized point cloud containing only the nonground points. Specify a threshold of 0.5 meters.

```
nonGroundPtCloud = select(ld.ptCloud,~groundPtsIdx,'OutputSize','full');  
distThreshold = 0.5;  
[labels,numClusters] = segmentLidarData(nonGroundPtCloud,distThreshold);
```

Display the nonground points cloud clusters.

```
figure  
colormap(hsv(numClusters))  
pcshow(nonGroundPtCloud.Location,labels)  
title('Point Cloud Clusters')
```

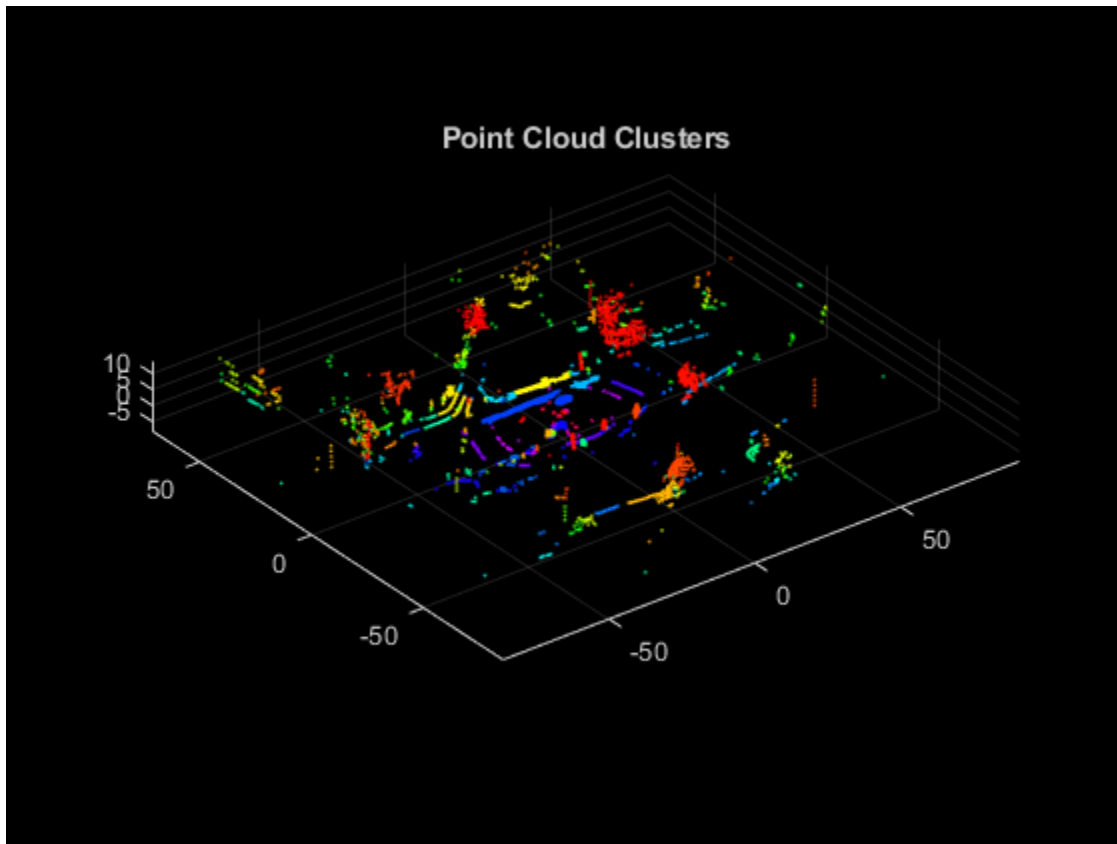

Segment and Plot Ground Plane using PCAP File

Load Velodyne PCAP® to the workspace.

```
velodyneFileReaderObj = velodyneFileReader('lidarData_ConstructionRoad.pcap', 'HDL32E');
```

Create a point cloud player using `pcplayer`. Define its x-, y-, and z-axes limits, in meters, and label its axes.

```
xlimits = [-40 40];  
ylimits = [-15 15];  
zlimits = [-3 3];  
player = pcplayer(xlimits,ylimits,zlimits);
```

Label the `pcplayer` axes.

```
xlabel(player.Axes, 'X (m)')  
ylabel(player.Axes, 'Y (m)')  
zlabel(player.Axes, 'Z (m)')
```

Set the colormap for labeling points. Use RGB triplets to specify green for ground-plane points, and red for obstacle points.

```
colors = [0 1 0; 1 0 0];
greenIdx = 1;
redIdx = 2;
```

Iterate through the first 200 point clouds in the Velodyne PCAP file, using `readFrame` to read in the data. Segment the ground points from each point cloud. Color all ground points green and nonground points red. Plot the resulting lidar point cloud.

```
colormap(player.Axes,colors)
title(player.Axes,'Segmented Ground Plane of Lidar Point Cloud');
for i = 1 : 200
    % Read current frame.
    ptCloud = velodyneFileReaderObj.readFrame(i);

    % Create label array.
    colorLabels = zeros(size(ptCloud.Location,1),size(ptCloud.Location,2));

    % Find the ground points.
    groundPtsIdx = segmentGroundFromLidarData(ptCloud);

    % Map color ground points to green.
    colorLabels(groundPtsIdx (:)) = greenIdx;

    % Map color nonground points to red.
    colorLabels(~groundPtsIdx (:)) = redIdx;

    % Plot the results.
    view(player,ptCloud.Location,colorLabels)
end
```

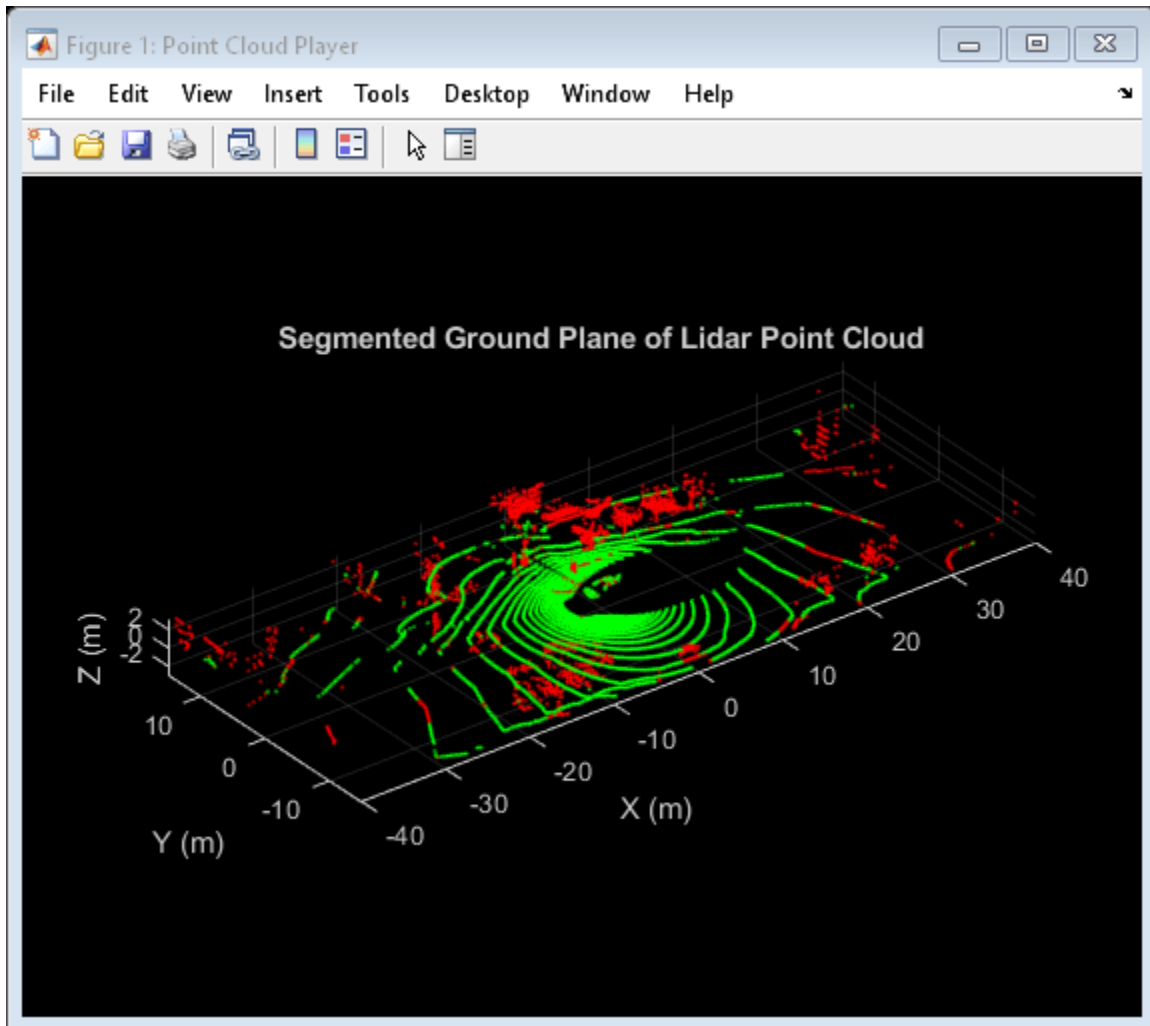

Input Arguments

ptCloud — Point cloud

pointCloud object

Point cloud, specified as a pointCloud object. ptCloud is an organized point cloud that stores $[x,y,z]$ point coordinates in an M -by- N -by-3 matrix.

Name-Value Pair Arguments

Example: 'ElevationAngleDelta',5

ElevationAngleDelta — Elevation angle difference threshold

5 (default) | nonnegative scalar

Elevation angle difference threshold to identify ground points, specified as a nonnegative scalar. The function computes the elevation angle difference between one labeled ground point and its 4-connected neighbors. The neighborhood point is labeled as ground if the difference is below the

threshold. Typical values for `ElevationAngleDelta` are in the range of [5,15] degrees. Increase this value to encompass more points from uneven ground surfaces.

InitialElevationAngle — Initial elevation angle threshold

30 (default) | non-negative scalar

Initial elevation angle threshold to identify the ground point in the scanning line closest to the lidar sensor, specified as a non-negative scalar. The function marks a point as ground when the elevation angle falls below this value. Typical values for `InitialElevationAngle` are in the range of 15 and 30 degrees.

Output Arguments

groundPtsIdx — Ground points index

logical matrix

Ground points index, returned as an M -by- N logical matrix. Elements with a `true` value, 1, indicate ground points. Elements with a `false` value, 0, indicate nonground points.

References

- [1] Bogoslavskyi, I. "Efficient Online Segmentation for Sparse 3D Laser Scans." *Journal of Photogrammetry, Remote Sensing and Geoinformation Science*. Vol. 85, Number 1, 2017, pp. 41-52.

Extended Capabilities

C/C++ Code Generation

Generate C and C++ code using MATLAB® Coder™.

GPU Code Generation

Generate CUDA® code for NVIDIA® GPUs using GPU Coder™.

Because of architectural differences between the CPU and GPU, numerical verification does not always match. The GPU floating-point units use fused Floating-Point Multiply-Add (FMAD) instructions while the CPU does not use these instructions. The CUDA compiler performs these instruction-level optimizations by default impacting the accuracy of the computed results. For example, the CUDA compiler fuses floating-point multiply and add instructions into a single instruction. This Floating-point Multiply-Add (FMAD) operation executes twice as fast compared to two single instructions but results in the loss of numerical accuracy. You can achieve tighter control over these optimizations by using compiler flags. For example, passing `--fmad=false` to the `Compiler Flags` property of the code configuration object instructs the `nvcc` compiler to disable contraction of floating-point multiply and add to a single Floating-Point Multiply-Add (FMAD) instruction. For more information, see "Generate Code by Using the GPU Coder App" (GPU Coder).

See Also

`pointCloud` | `pcsegdist` | `pcfitplane` | `velodyneFileReader` | `segmentLidarData`

Introduced in R2018b

focalCrossEntropy

Compute focal cross-entropy loss

Syntax

```
dLY = focalCrossEntropy(dlX, targets)
dLY = focalCrossEntropy(dlX, targets, 'DataFormat', FMT)
dLY = focalCrossEntropy( ____, Name, Value)
```

Description

`dLY = focalCrossEntropy(dlX, targets)` computes the focal cross-entropy between network predictions and target values for single-label and multi-label classification tasks. The classes are mutually-exclusive classes. The focal cross-entropy loss weights towards poorly classified training samples and ignores well-classified samples. The focal cross-entropy loss is computed as the average logarithmic loss divided by number of non-zero targets.

`dLY = focalCrossEntropy(dlX, targets, 'DataFormat', FMT)` also specifies the dimension format FMT when `dlX` is not a formatted `dLarray`.

`dLY = focalCrossEntropy(____, Name, Value)` specifies options using one or more name-value pair arguments in addition to the input arguments in previous syntaxes. For example, `'TargetCategories', 'independent'` computes the cross-entropy loss for a multi-label classification task.

Examples

Compute Focal Cross-Entropy Loss Using Formatted `dLarray`

Create the input classification data as 32 observations of random variables belonging to 10 classes or categories.

```
numCategories = 10;
observations = 32;
X = rand(numCategories, observations);
```

Create a formatted deep learning array that has a data format with the labels 'C' and 'B'.

```
dlX = dLarray(X, 'CB');
```

Use the `softmax` function to set all values in the input data to values between 0 and 1 that sum to 1 over all channels. The values specify the probability of each observation to belong to a particular category.

```
dlX = softmax(dlX);
```

Create the target data as unformatted deep learning array, which holds the correct category for each observation in `dlX`. Set the targets belonging to the second category as one-hot encoded vectors.

```
targets = darray(zeros(numCategories,observations));
targets(2,:) = 1;
```

Compute the focal cross-entropy loss between each prediction and the target.

```
dLY = focalCrossEntropy(dLX,targets, 'Reduction', 'none');
```

Compute Average Focal Cross-Entropy Loss Using Unformatted darray

Create the input classification data as 32 observations of random variables belonging to 10 classes or categories.

```
numCategories = 10;
observations = 32;
X = rand(numCategories,observations);
```

Create an unformatted deep learning array.

```
dLX = darray(X);
```

Use the `softmax` function to set all values in the input data to values between 0 and 1 that sum to 1 over all channels. The values specify the probability for each observation to belong to a particular category.

```
dLX = softmax(dLX, 'DataFormat', 'CB');
```

Create the target data. Set the targets belonging to the second category as one-hot encoded vectors.

```
targets = zeros(numCategories,observations);
targets(2,:) = 1;
```

Compute the average of focal cross-entropy loss computed between the predictions and the targets.

```
dLY = focalCrossEntropy(dLX,targets, 'DataFormat', 'CB')
```

```
dLY =
    1x1 darray
    0.4769
```

Compute Average Focal Cross-Entropy Loss for Multi-Label Classification

Create the input classification data as 32 observations of random variables belonging to 10 classes or categories.

```
numCategories = 10;
observations = 32;
X = rand(numCategories,observations);
```

Create a formatted deep learning array that has a data format with the labels 'C' and 'B'.

```
dLX = darray(X, 'CB');
```

Use the `sigmoid` function to set all values in the input data to values between 0 and 1 that sum to 1 over all channels. The values specify the probability of each observation to belong to a particular category.

```
dLX = sigmoid(dLX);
```

Create the target data, which holds the correct category for each observation in `dLX`. Set the targets belonging to the second and sixth category as one-hot encoded vectors.

```
targets = zeros(numCategories, observations);
targets(2,:) = 1;
targets(6,:) = 1;
```

Compute the average of focal cross-entropy loss computed between the predictions and the targets. Set the 'TargetCategories' value to 'independent' for multi-label classification.

```
dLY = focalCrossEntropy(dLX, targets, 'TargetCategories', 'independent')
```

```
dLY =
    1x1 dlarray
    2.4362
```

Input Arguments

dLX — Predictions

`dlarray` | numeric array

Predictions, specified as a `dlarray` with or without dimension labels or a numeric array. When `dLX` is not a formatted `dlarray`, you must specify the dimension format using 'DataFormat', `FMT`. If `dLX` is a numeric array, `targets` must be a `dlarray`.

Data Types: `single` | `double`

targets — Target classification labels

`dlarray` | numeric array

Target classification labels, specified as a formatted or unformatted `dlarray` or a numeric array.

If `targets` is a formatted `dlarray`, its dimension format must be the same as the format of `dLX`, or the same as 'DataFormat' if `dLX` is unformatted

If `targets` is an unformatted `dlarray` or a numeric array, the size of `targets` must exactly match the size of `dLX`. The format of `dLX` or the value of 'DataFormat' is implicitly applied to `targets`.

Data Types: `single` | `double`

Name-Value Pair Arguments

Specify optional comma-separated pairs of `Name`, `Value` arguments. `Name` is the argument name and `Value` is the corresponding value. `Name` must appear inside quotes. You can specify several name and value pair arguments in any order as `Name1`, `Value1`, ..., `NameN`, `ValueN`.

Example: 'TargetCategories', 'independent', 'DataFormat', 'CB' evaluates the focal cross-entropy loss for multi-label classification tasks and specifies the dimension order of the input data as 'CB'

Gamma — Focusing parameter

0.25 (default) | positive real number

Focusing parameter of the focal loss function, specified as the comma-separated pair consisting of 'Gamma' and a positive real number. Increasing the value of Gamma increases the sensitivity of the network to misclassified observations.

Alpha — Balancing parameter

2 (default) | positive real number

Balancing parameter of the focal loss function, specified as the comma-separated pair consisting of 'Alpha' and a positive real number. The Alpha value scales the loss function linearly and is typically set to 0.25. If you decrease Alpha, increase Gamma.

Reduction — Type of output loss

'mean' (default) | 'none'

Type of output loss, specified as the comma-separated pair consisting of 'Reduction' and one of the following:

- 'mean' — Average of output loss for each prediction. The function computes the average of loss values computed for each predictions in input dLX. The function returns the average loss as an unformatted dLarray. Observations with all zero target values along the channel dimension are excluded from computing the average loss.
- 'none' — Output loss for each prediction. The function returns the loss values for each observation in dLX. The samples for computing focal cross-entropy loss also contains observations whose target values are all zeros along the channel dimension. If dLX is a formatted dLarray, output dLY is a formatted dLarray with same dimension labels as dLX. If dLX is an unformatted dLarray, output dLY is an unformatted dLarray.

The default value is 'mean'.

Example: 'Reduction', 'mean'

Data Types: char | string

TargetCategories — Type of classification task

'exclusive' (default) | 'independent'

Type of classification task, specified as the comma-separated pair consisting of 'TargetCategories' and one of the following:

- 'exclusive' — Single-label classification. Each observation in the predictions dLX is exclusively assigned to one category.
- 'independent' — Multi-label classification. Each observation in the predictions dLX can be assigned to one or more independent categories.

The default value is 'exclusive'.

DataFormat — Dimension order of unformatted data

char array | string

Dimension order of unformatted input data, specified as the comma-separated pair consisting of 'DataFormat' and a character array or string FMT that provides a label for each dimension of the data. Each character in FMT must be one of the following:

- 'S' — Spatial
- 'C' — Channel
- 'B' — Batch (for example, samples and observations)
- 'T' — Time (for example, sequences)
- 'U' — Unspecified

You can specify multiple dimensions labeled 'S' or 'U'. You can use the labels 'C', 'B', and 'T' at most once.

You must specify 'DataFormat' when the input data `dLX` is not a formatted `dLarray`.

Example: 'DataFormat', 'SSCB'

Data Types: `char` | `string`

Output Arguments

dLY — Focal cross-entropy loss

`dLarray` scalar

Focal cross-entropy loss, returned as a `dLarray` scalar without dimension labels. The output `dLY` has the same underlying data type as the input `dLX`.

See Also

`focalLossLayer` | `softmax` | `sigmoid` | `crossentropy` | `mse`

Topics

"Lidar 3-D Object Detection Using PointPillars Deep Learning" (Lidar Toolbox)

Introduced in R2020b

bboxerase

Remove bounding boxes

Syntax

```
bboxB = bboxerase(bboxA,window)
[bboxB,indices] = bboxerase(bboxA,window)
___ = bboxerase( ___, 'EraseThreshold', threshold)
```

Description

`bboxB = bboxerase(bboxA,window)` removes bounding boxes in the input `bboxA` that lie within a region of interest (ROI) specified by `window`. The output is the set of bounding boxes retained from the input `bboxA`.

Note To perform random erase or cutout data augmentation, use `bboxerase` along with the `imerase` function.

`[bboxB,indices] = bboxerase(bboxA,window)` also returns the indices of the bounding boxes retained from the input set of bounding boxes `bboxIn`.

`___ = bboxerase(___, 'EraseThreshold', threshold)` additionally specifies the threshold for the amount of overlap between a bounding box region and the specified ROI. A bounding box is removed if the overlap between the bounding box region and the ROI is equal to or greater than the specified threshold.

Examples

Perform Random Erase Augmentation

Read an image.

```
I = imread('peppers.png');
```

Define bounding boxes and labels.

```
bboxA = [410 230 100 90;
         186 78 80 60];
labelsA = ["garlic";"onion"];
```

Find the size of the input image

```
inputSize = size(I);
```

To randomly select a region of interest (ROI), specify a range for the scale and the aspect ratio of the ROI. The scale value for the ROI is set to lie in the range 0.2 and 0.3. Similarly, the minimum value for the aspect ratio is set to lie in the range 1:10 and the maximum value for the aspect ratio is set to lie in the range 30:100.

```
scale = [0.2,0.3];
dimensionRatio = [1,10;30,100];
```

Select the ROI by using the `randomWindow2d` function.

```
window = randomWindow2d(inputSize, 'Scale', scale, 'DimensionRatio', dimensionRatio);
```

Remove the pixels and the bounding boxes that lie within the randomly selected ROI.

```
J = imerase(I,window);
[bboxB,indices] = bboxerase(bboxA,window);
labelsB = labelsA(indices);
```

Display the original and augmented image.

```
annotatedI = insertObjectAnnotation(I, 'Rectangle', bboxA, labelsA);
annotatedJ = insertObjectAnnotation(J, 'Rectangle', bboxB, labelsB);
figure
montage({annotatedI,annotatedJ})
title(['Input | Random Erase Output'])
```

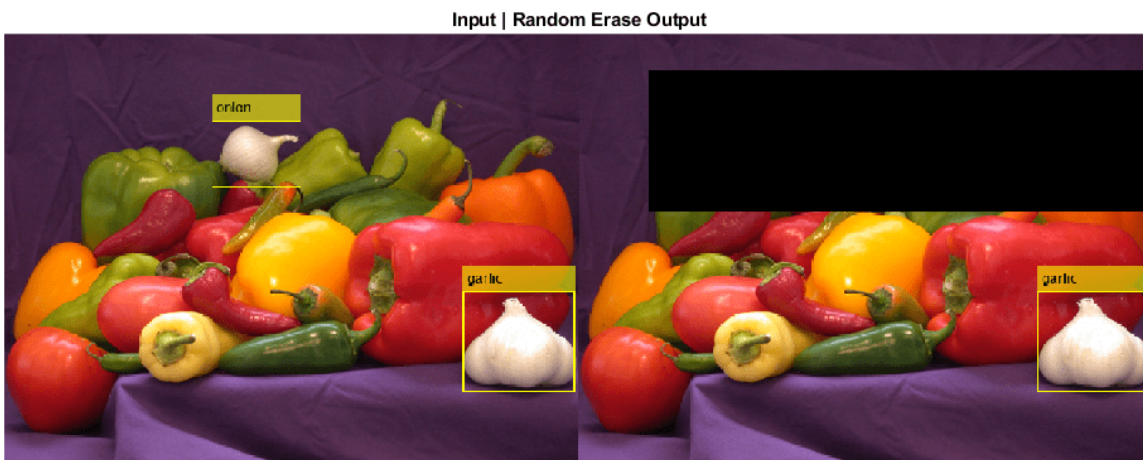

Perform Cutout Data Augmentation

Read an image.

```
I = imread('visionteam1.jpg');
```

Define bounding boxes and labels.

```
bboxA = [64 101 117 440;
193 101 67 309;
282 86 114 375;
618 118 79 345;
486 55 131 528;
475 109 66 361];
```

```
labelsA = ["Person 1";"Person 2";"Person 3";"Person 4";"Person 5";"Person 6"];
```

Specify a rectangular region of interest.

```
window = [470 100 90 360];
```

Erase the pixels that lie within the rectangular region by using `imerase` function.

```
J = imerase(I,window);
```

Erase the bounding boxes that lie within the rectangular region. Set the erase threshold value to 0.7. The `bboxerase` function returns the retained bounding boxes and the corresponding indices.

```
[bboxB,indices] = bboxerase(bboxA,window,'EraseThreshold',0.7);
```

Read the class labels corresponding to the retained bounding boxes.

```
labelsB = labelsA(indices);
```

Display the results.

```
figure
```

```
I = insertObjectAnnotation(I,'Rectangle',bboxA,labelsA);
```

```
J = insertObjectAnnotation(J,'Rectangle',bboxB,labelsB);
```

```
imshowpair(I,J,'montage')
```

```
title(['Number of input bounding boxes: ', num2str(length(labelsA)), ' | ', 'Number of output bounding boxes: ', num2str(length(labelsB))]);
```

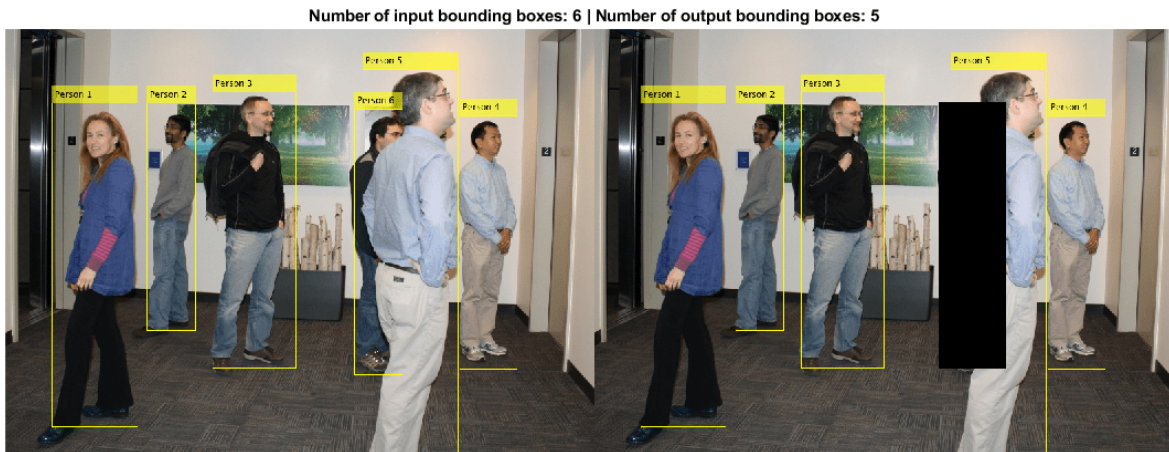

Input Arguments

bboxA — Input set of bounding boxes

M-by-4 matrix

Input set of bounding boxes, specified as *M*-by-4 matrix. *M* is the number of bounding boxes. Each row in the matrix is of form $[x_{min} \ y_{min} \ width \ height]$. $[x_{min} \ y_{min}]$ are the top left coordinates of the bounding box. *width* and *height* are the width and the height of the bounding box respectively.

Data Types: `single` | `double` | `int8` | `int16` | `int32` | `int64` | `uint8` | `uint16` | `uint32` | `uint64`

window — Region of interest

4-element vector | `Rectangle` object

Region of interest, specified as one of these values:

- 4 -element vector of form $[x \ y \ width \ height]$. $[x \ y]$ are the top left coordinates of the ROI. *width* and *height* are the width and the height of the ROI respectively.
- `Rectangle` object.

Data Types: `single` | `double` | `int8` | `int16` | `int32` | `int64` | `uint8` | `uint16` | `uint32` | `uint64`

threshold — Erase threshold

0.8 (default) | positive scalar

Erase threshold, specified as a positive scalar less than or equal to 1. The erase threshold sets the criteria for removing a bounding box from the input set `bboxA`. The value is the ratio of number of pixels in a bounding box that lie inside the ROI (overlapping pixels) to the total number of pixels in the bounding box.

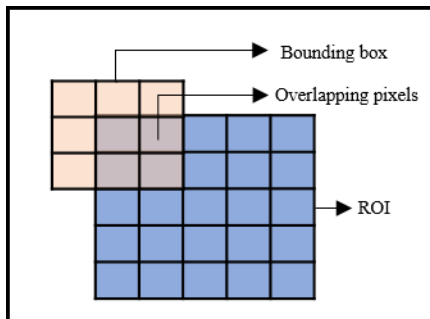

$$\text{threshold} = \frac{\text{Number of overlapping pixels}}{\text{Total number of pixels in bounding box}}$$

The default value is 0.8. This implies that, a bounding box is removed if 80 % of the pixels in the bounding box lie within the specified ROI.

Data Types: `single` | `double` | `int8` | `int16` | `int32` | `int64` | `uint8` | `uint16` | `uint32` | `uint64`

Output Arguments

bboxB — Output bounding boxes retained from the input

N -by-4 matrix

Output bounding boxes retained from the input, returned as a N -by-4 matrix. N is the number of bounding boxes retained from the input. Each row of the matrix defines one bounding box of the same type as the input `bboxA`. The value of N is always less than or equal to M , the number of input bounding boxes.

Data Types: `single` | `double` | `int8` | `int16` | `int32` | `int64` | `uint8` | `uint16` | `uint32` | `uint64`

indices — Indices of retained bounding boxes

vector

Indices of retained bounding boxes, returned as a vector of integers. The indices indicate which bounding boxes in the input, `bboxA`, are retained and returned at the output.

See Also

`imerase` | `Rectangle` | `randomWindow2d` | `imref2d` | `affineOutputView` | `insertObjectAnnotation`

Introduced in R2021a

